



US00D387641S

# United States Patent [19]

Naft et al.

[11] Patent Number: **Des. 387,641**

[45] Date of Patent: **\*\*Dec. 16, 1997**

[54] **COMBINATION CAN OPENER AND KNIFE SHARPENER**

D. 362,377 9/1995 Schweizer ..... D8/35  
4,734,985 4/1988 Ozaki ..... 30/404

[75] Inventors: **Stuart Naft, Fairfield; Patrick B. Nolan, Westport, both of Conn.**

*Primary Examiner*—Caron D. Veynar  
*Attorney, Agent, or Firm*—Barry E. Deutsch

[73] Assignee: **Black & Decker Inc., Newark, Del.**

[57] **CLAIM**

[\*\*] Term: **14 Years**

The ornamental design for a combination can opener and knife sharpener, shown and described.

[21] Appl. No.: **64,671**

**DESCRIPTION**

[22] Filed: **Jan. 8, 1997**

FIG. 1 is a perspective view taken from the front, top, and right side of a combination can opener and knife sharpener showing our new design;

[51] LOC (6) Cl. .... **07-99**

[52] U.S. Cl. .... **D8/35; D8/36**

FIG. 2 is a front elevational view thereof;

[58] Field of Search ..... **D8/18, 19, 33-43;**

FIG. 3 is a rear elevational view thereof;

**7/151-156; 30/400-404, 448**

FIG. 4 is a left side elevational view thereof;

FIG. 5 is a right side elevational view thereof;

[56] **References Cited**

**U.S. PATENT DOCUMENTS**

FIG. 6 is a top plan view thereof; and,

FIG. 7 is a bottom plan view thereof.

D. 326,041 5/1992 Rowley ..... D8/35

**1 Claim, 4 Drawing Sheets**

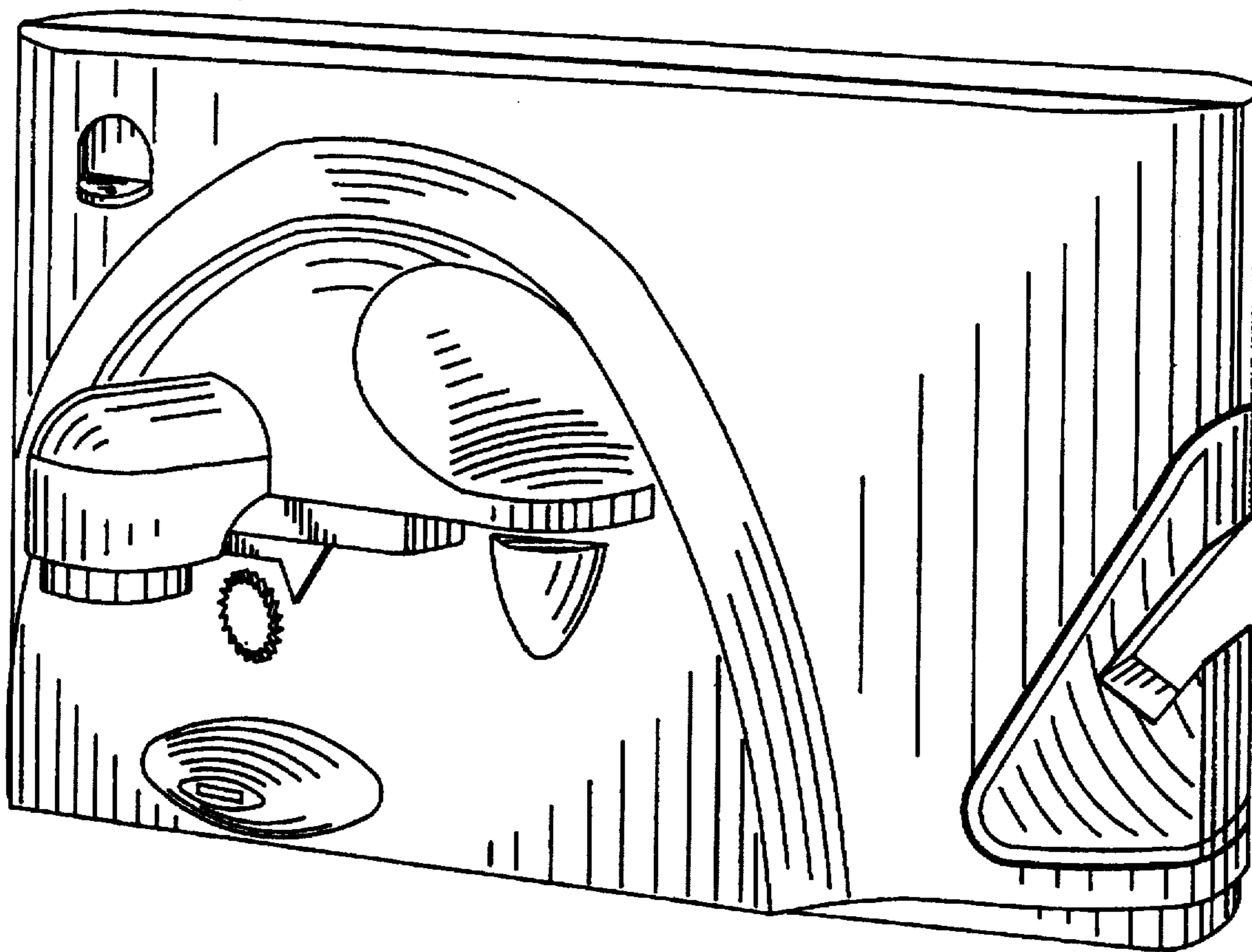

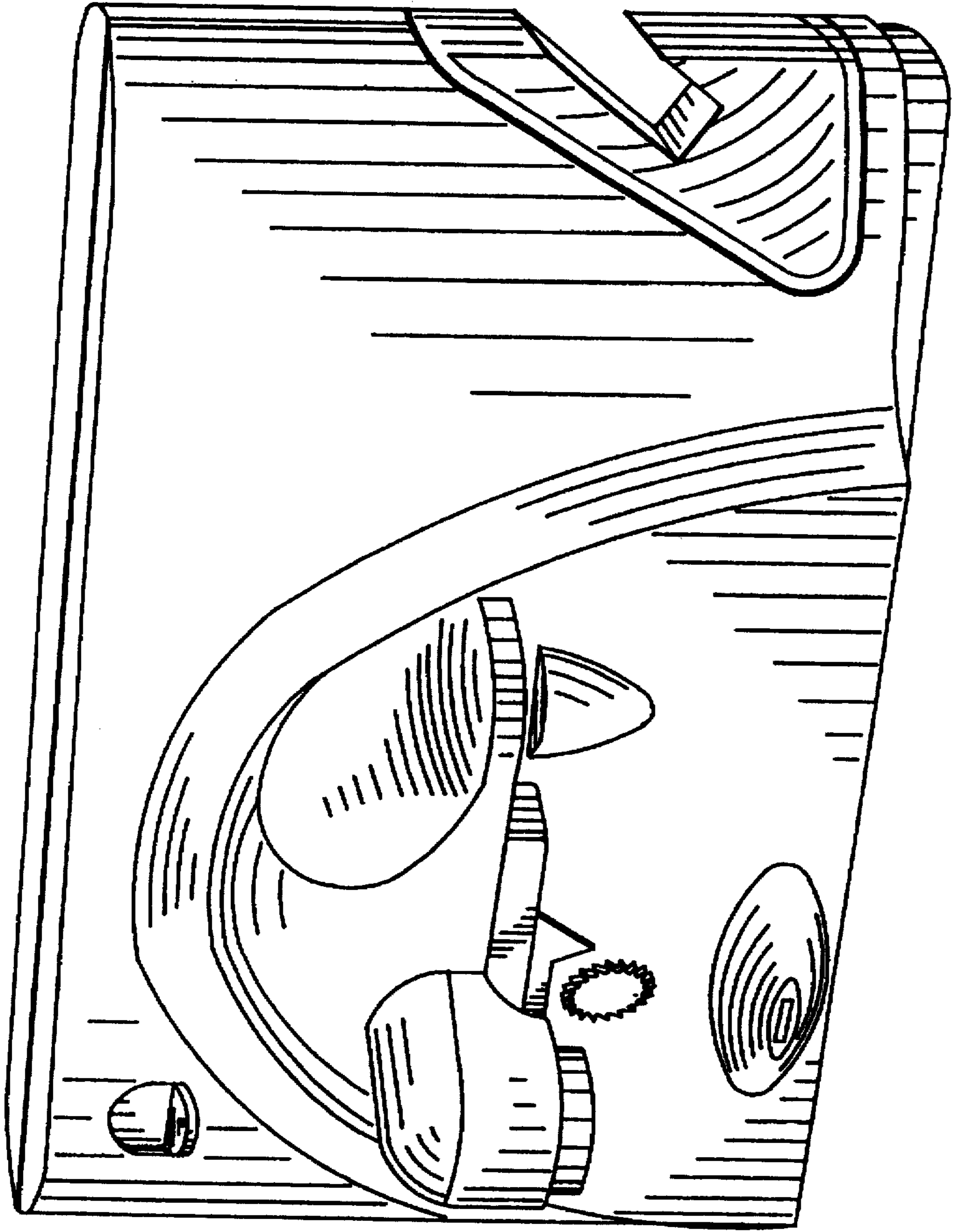

FIG. 1

FIG. 2

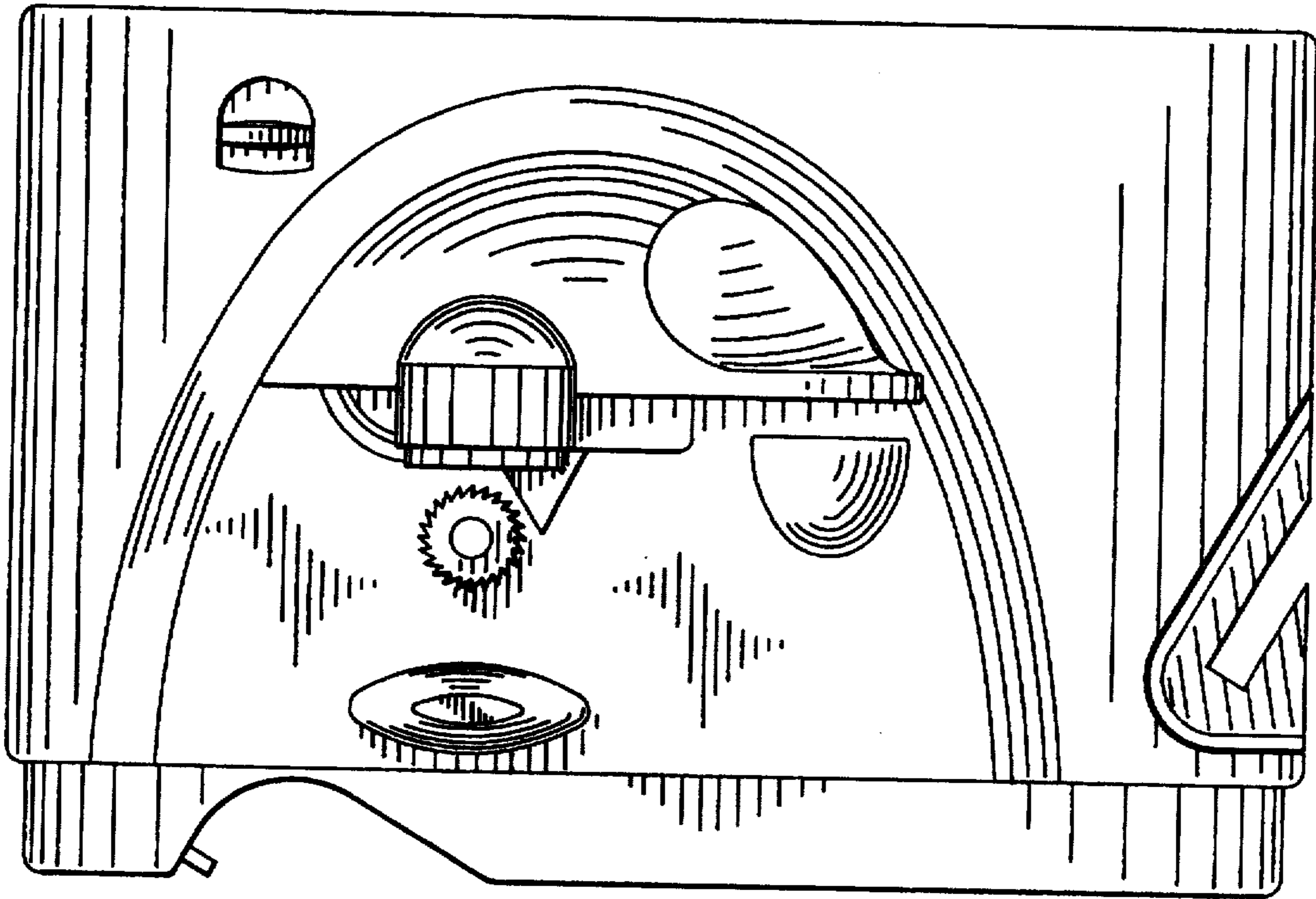

FIG. 3

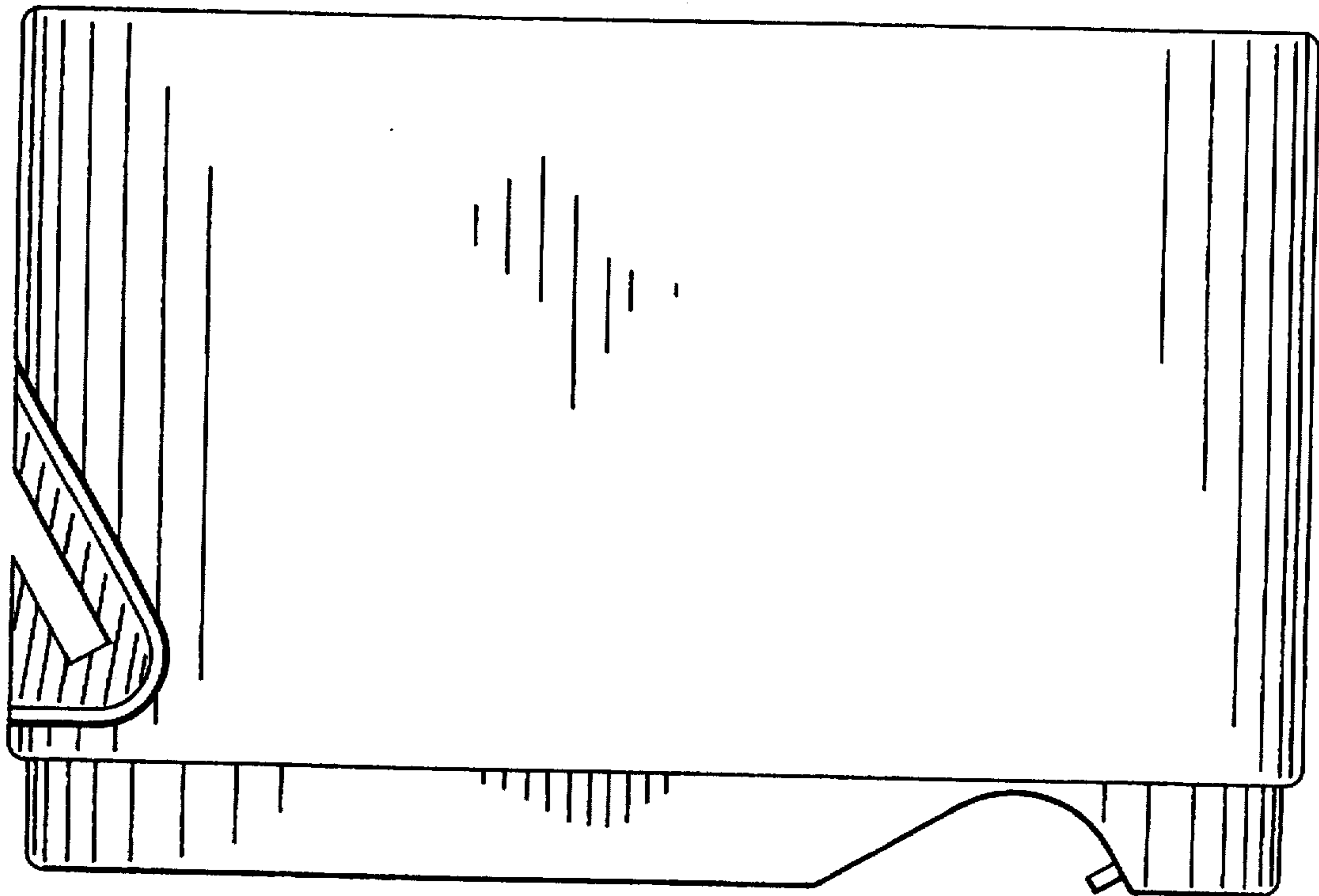

FIG. 5

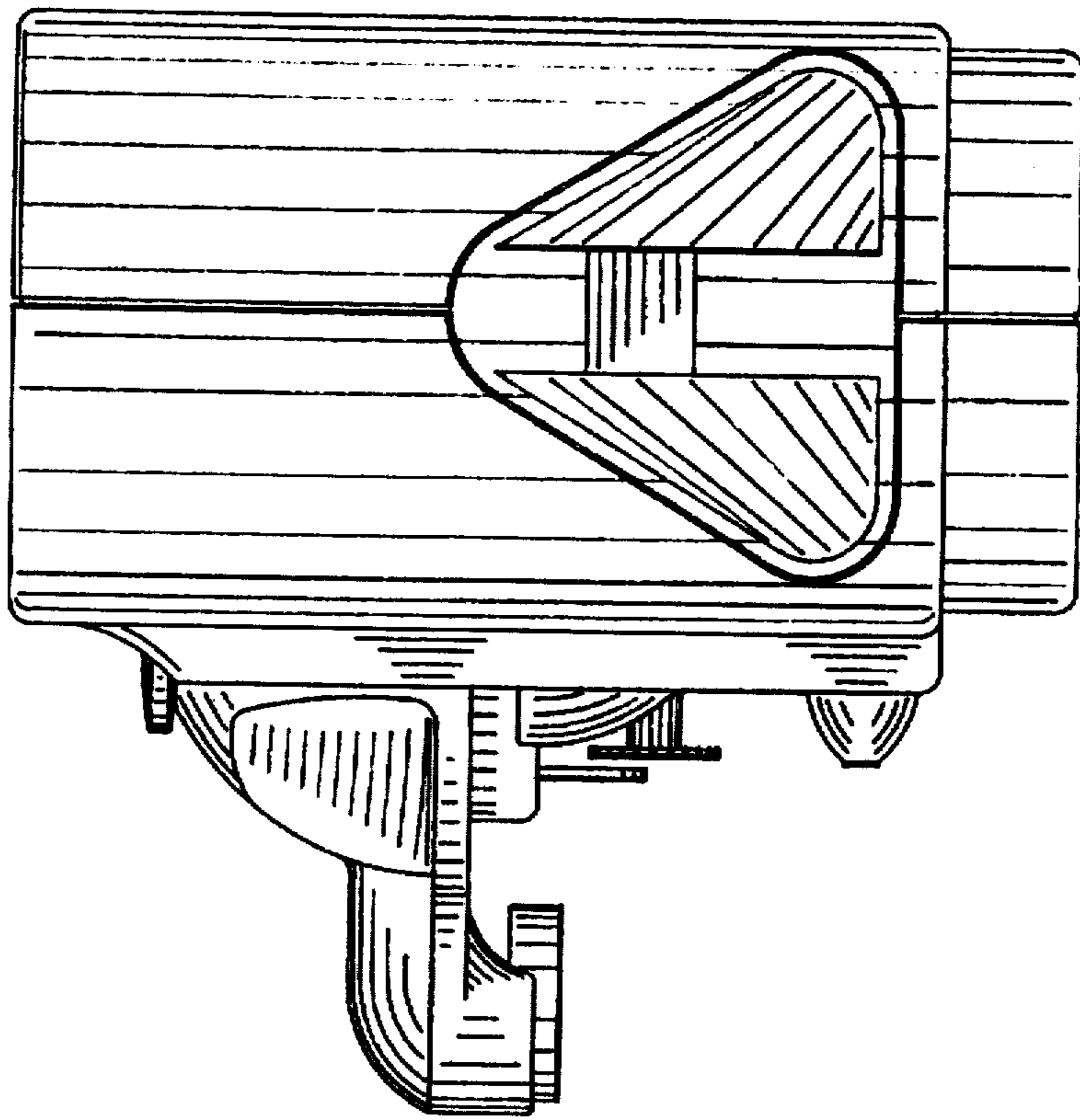

FIG. 4

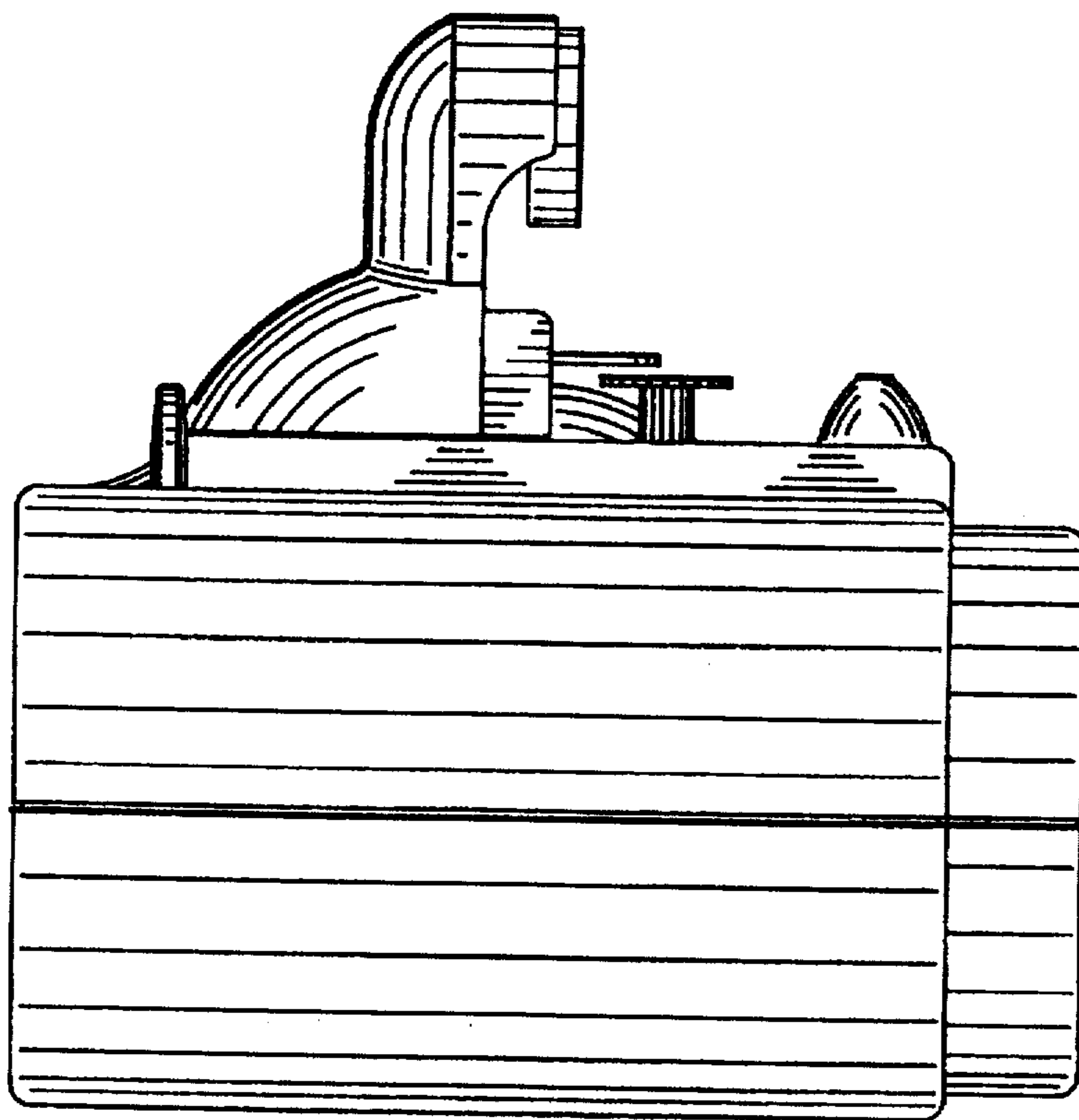

FIG. 6

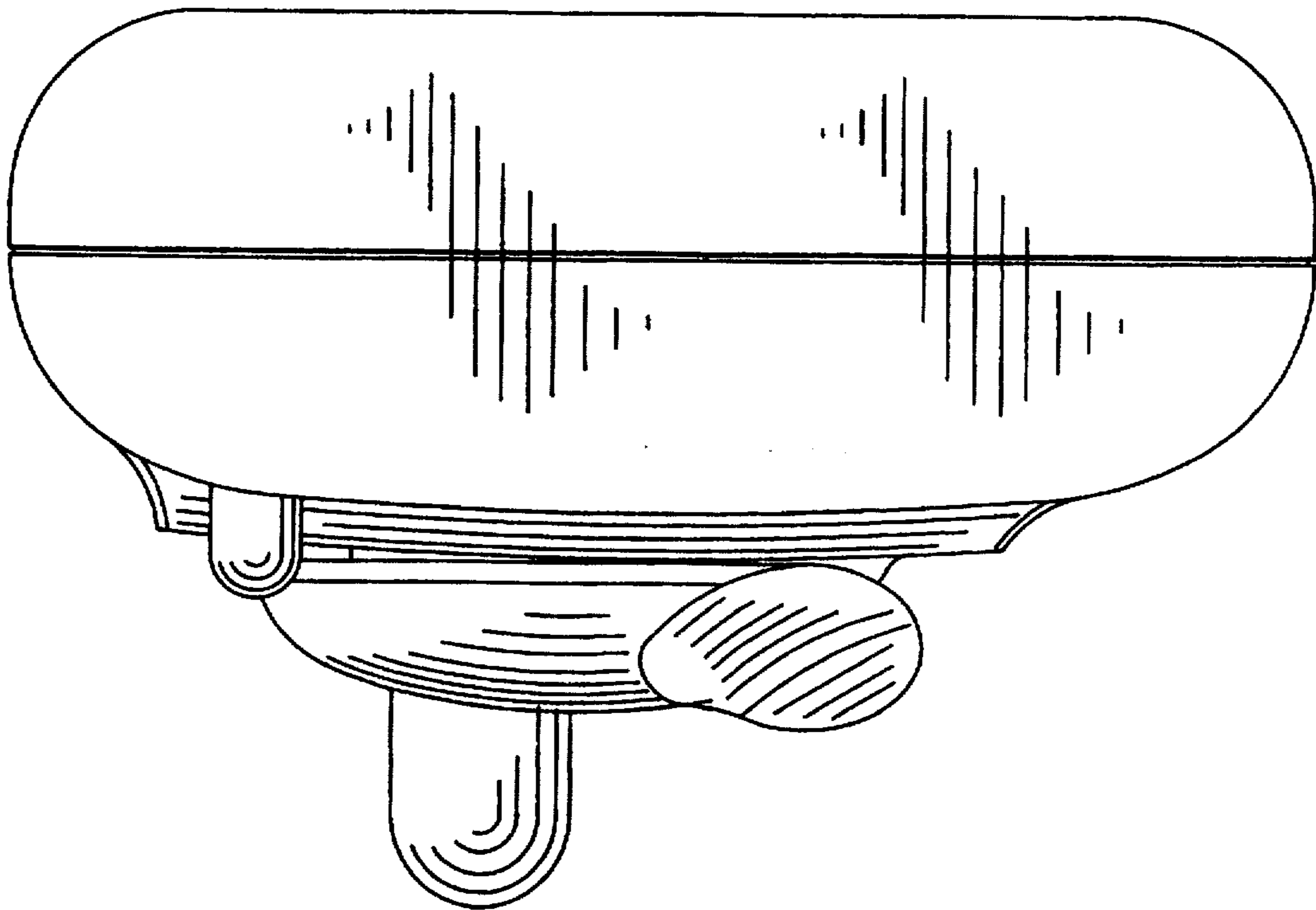

FIG. 7

