



US00D387629S

**United States Patent** [19]  
**Thierry**

[11] **Patent Number: Des. 387,629**  
[45] **Date of Patent: \*\*Dec. 16, 1997**

[54] **SPATULA**

[75] **Inventor: Agnès Thierry, Boulogne, France**

[73] **Assignee: Reckitt & Colman France, Massy, France**

[\*\*] **Term: 14 Years**

[21] **Appl. No.: 61,386**

[22] **Filed: Oct. 23, 1996**

[30] **Foreign Application Priority Data**

Apr. 30, 1996 [GB] **United Kingdom** ..... 2055969

[51] **LOC (6) Cl.** ..... **07-02**

[52] **U.S. Cl.** ..... **D7/688**

[58] **Field of Search** ..... D7/688-692, 649-652;  
294/7, 8; 30/169; D32/40, 46

[56] **References Cited**

**U.S. PATENT DOCUMENTS**

D. 211,656 7/1968 Uldall ..... D7/688

D. 331,686 12/1992 Persson ..... D7/649

*Primary Examiner*—Terry A. Wallace

*Attorney, Agent, or Firm*—Fish & Richardson P.C.

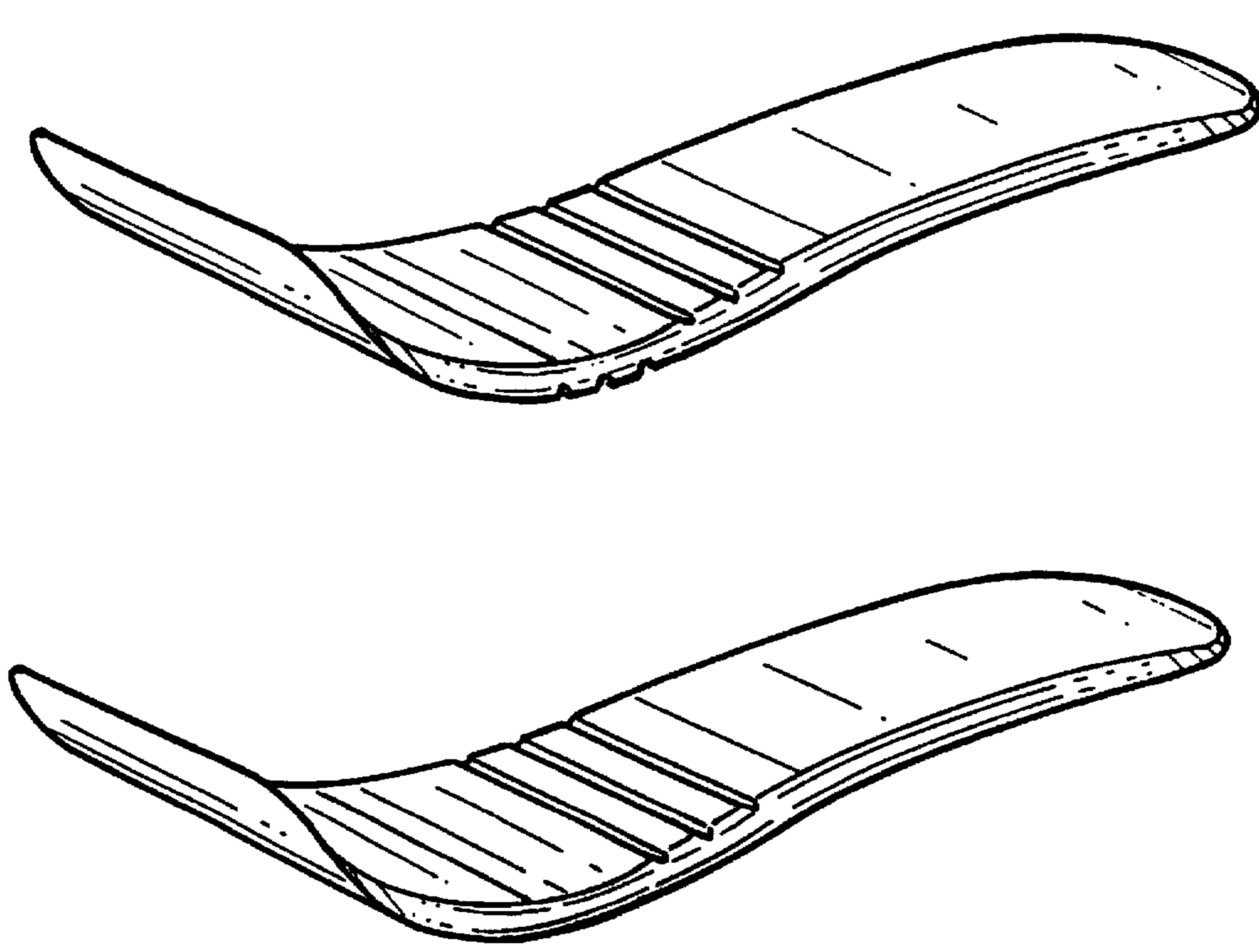
[57] **CLAIM**

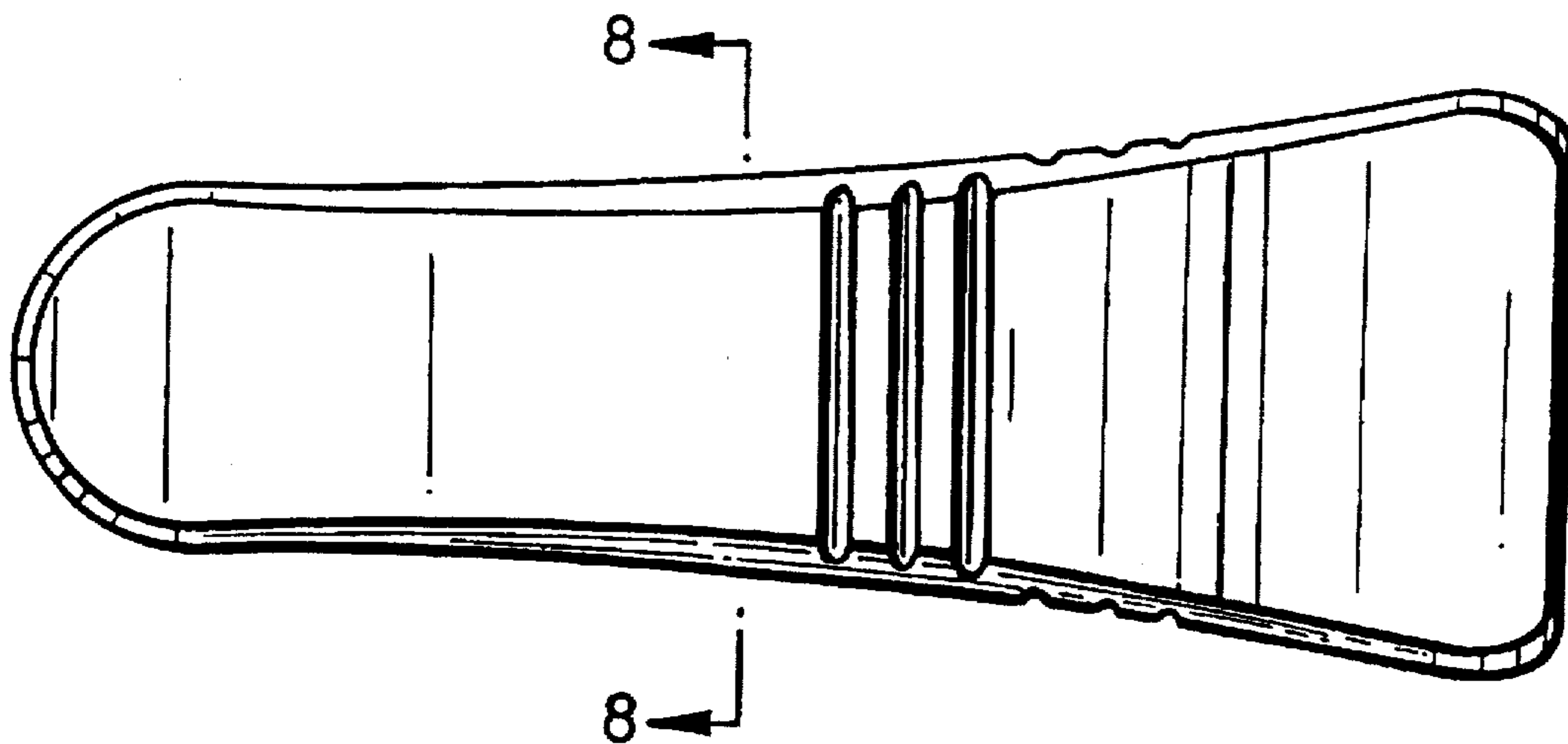
The ornamental design for a spatula, as shown and described.

**DESCRIPTION**

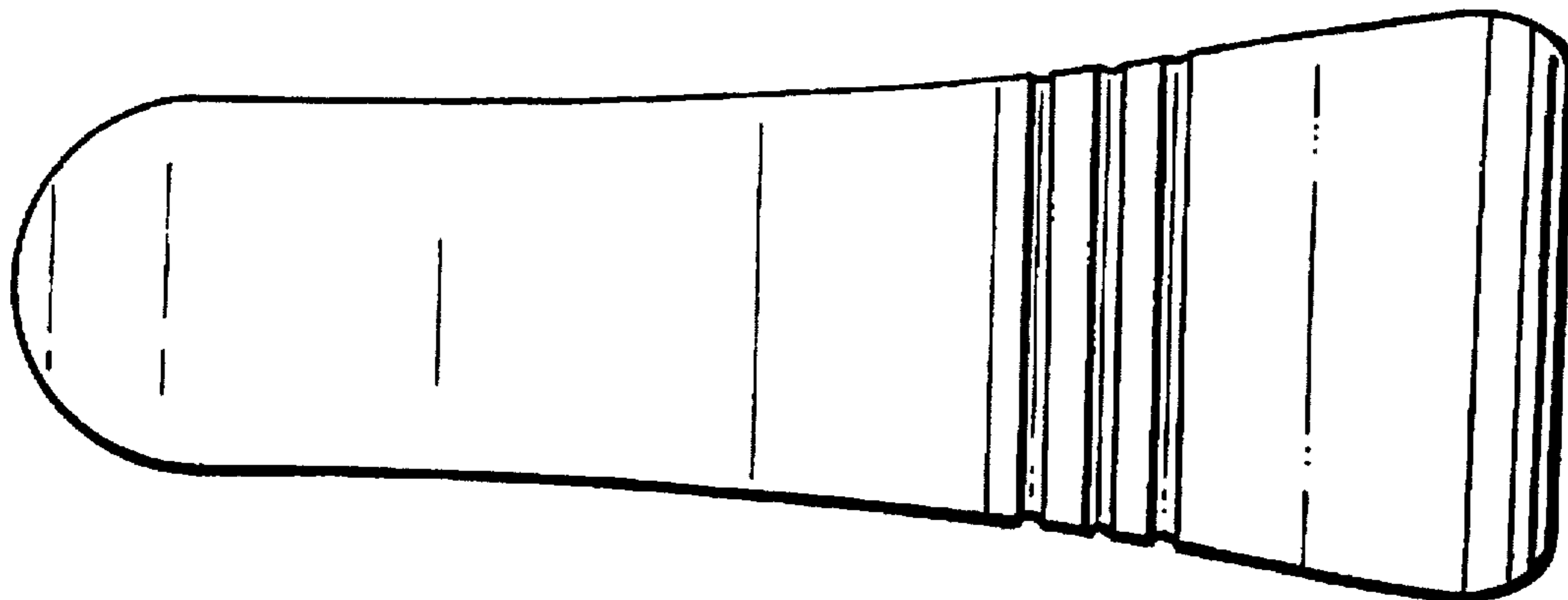
FIG. 1 is a top plan view of a spatula showing my new design;  
FIG. 2 is a bottom plan view thereof;  
FIG. 3 is a left-side view thereof, the right side being a mirror image of said figure;  
FIG. 4 is a top and left-side perspective view thereof;  
FIG. 5 is a top, partial bottom and right-side perspective view thereof;  
FIG. 6 is an end view thereof taken from the left side of FIG. 1;  
FIG. 7 is an end view thereof taken from the right side of FIG. 2; and,  
FIG. 8 is a sectional view thereof taken along line 8—8 of FIG. 1;  
FIG. 9 is a top and left side perspective view of an alternate embodiment of FIG. 1;  
FIG. 10 is a top, partial bottom and right side perspective view of FIG. 9;  
FIG. 11 is a top plan view of FIG. 9;  
FIG. 12 is a bottom plan view of FIG. 9;  
FIG. 13 is a left side view of FIG. 9, the right side view being a mirror image of said figure;  
FIG. 14 is an end view of FIG. FIG. 9 taken from the left side of FIG. 11;  
FIG. 15 is an end view of FIG. 9 taken from the right side of FIG. 12;  
FIG. 16 (substantially identical to FIG. 8) is a sectional view taken along line 16—16 of FIG. 11; and,  
FIG. 17 is a sectional view taken along line 17—17 of FIG. 11.

**1 Claim, 6 Drawing Sheets**

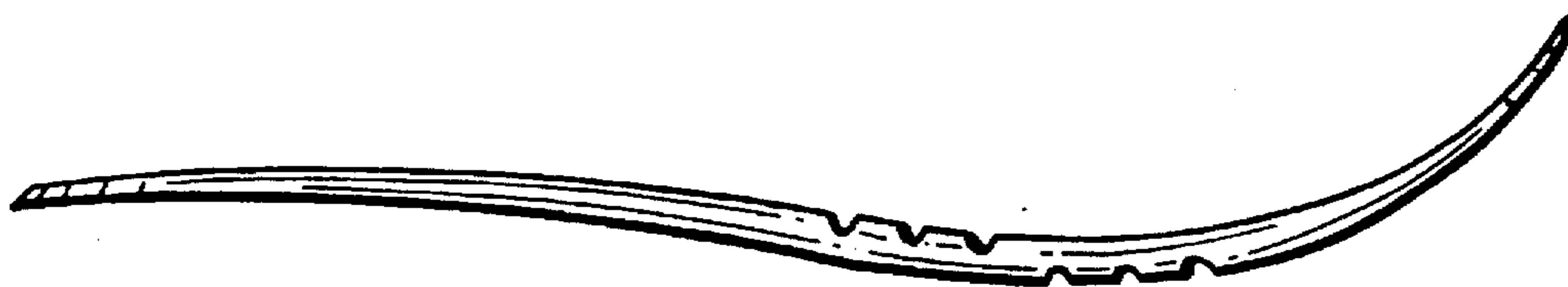




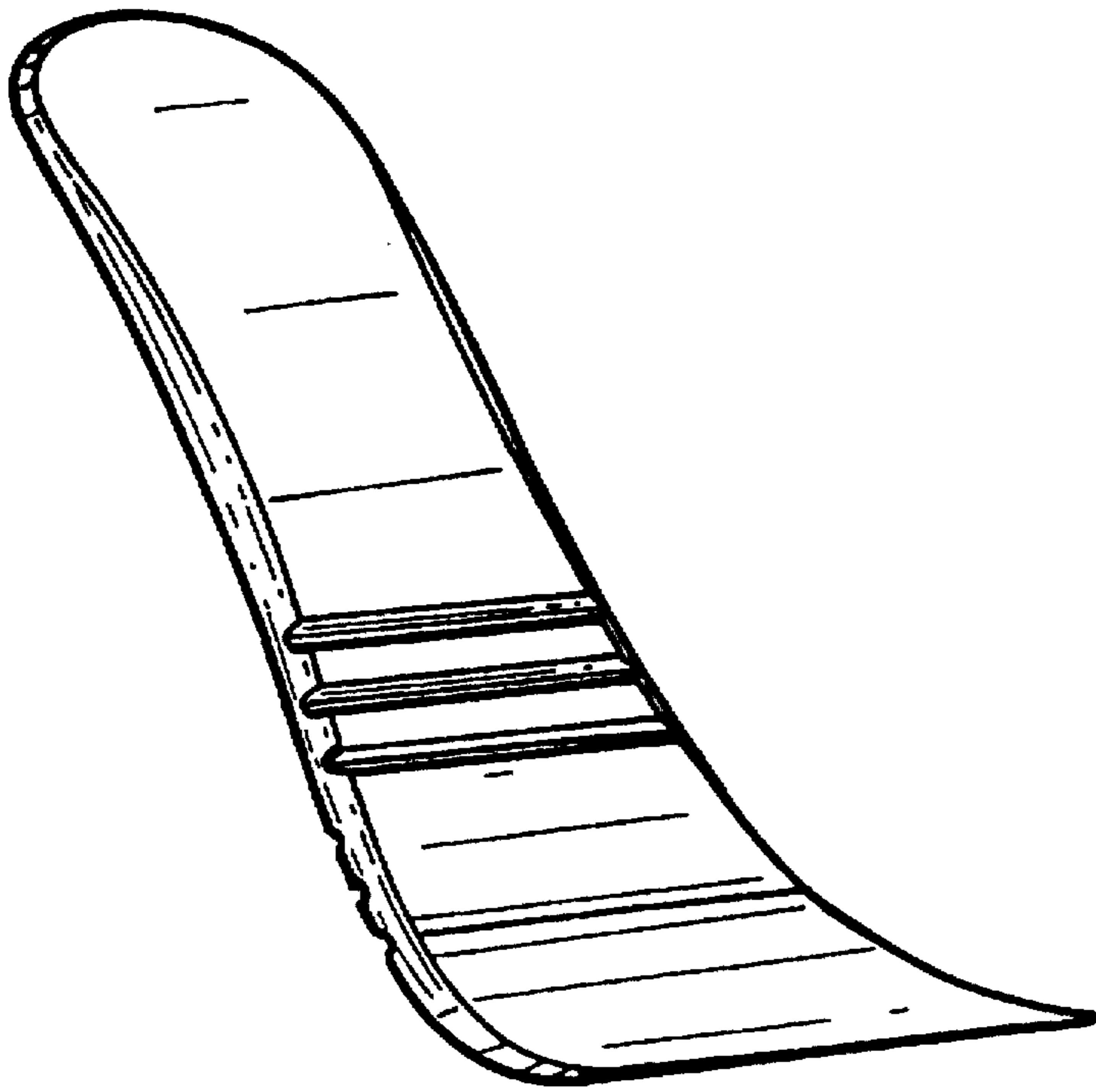
**FIG. 1**



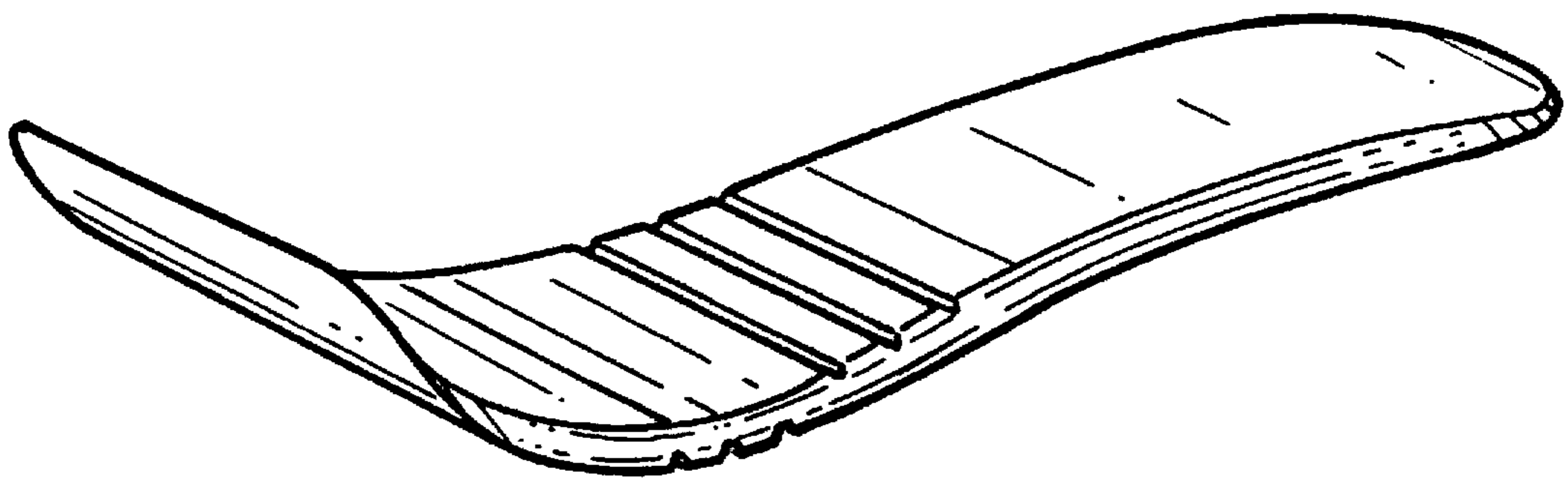
**FIG. 2**



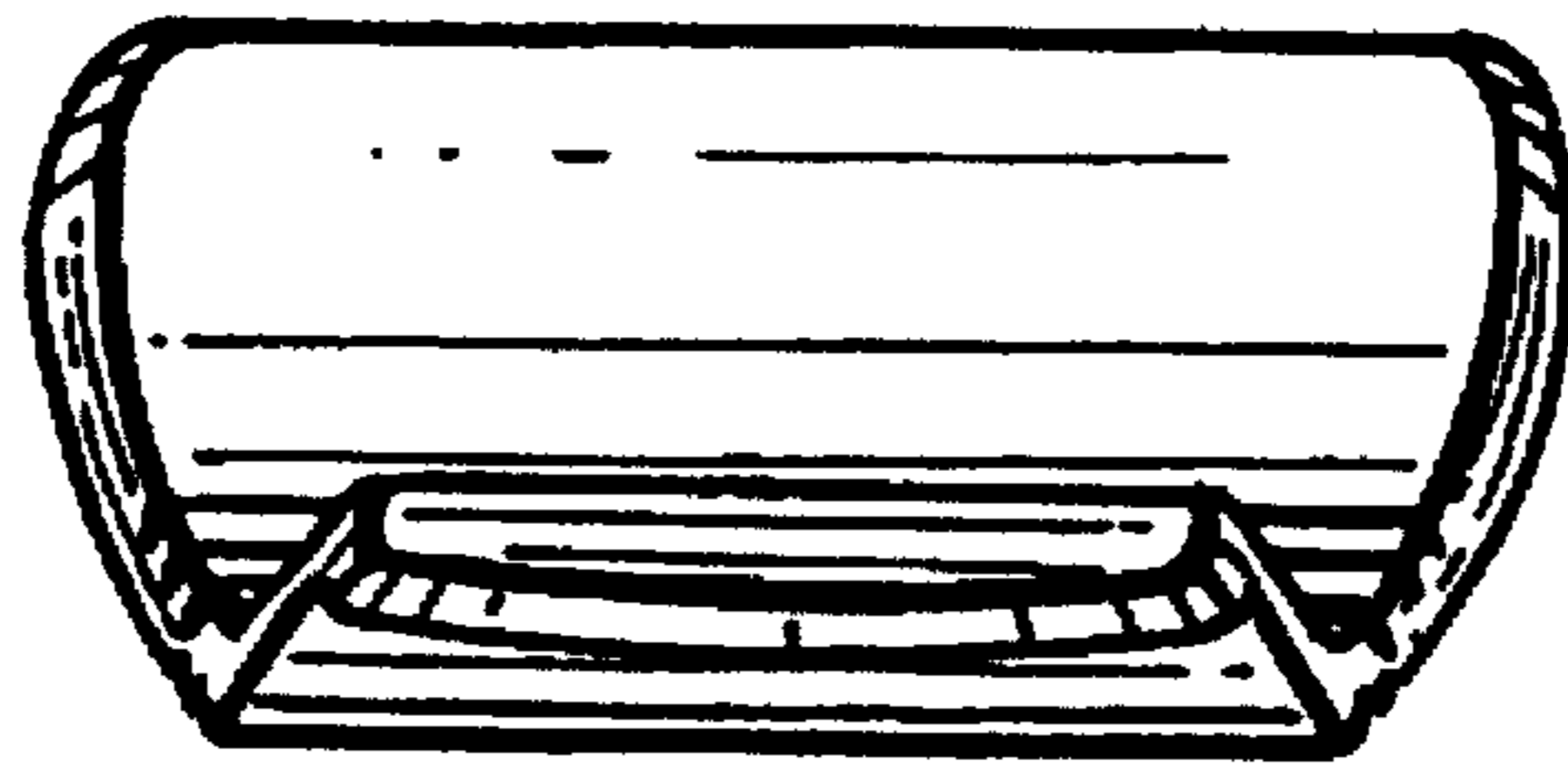
**FIG. 3**



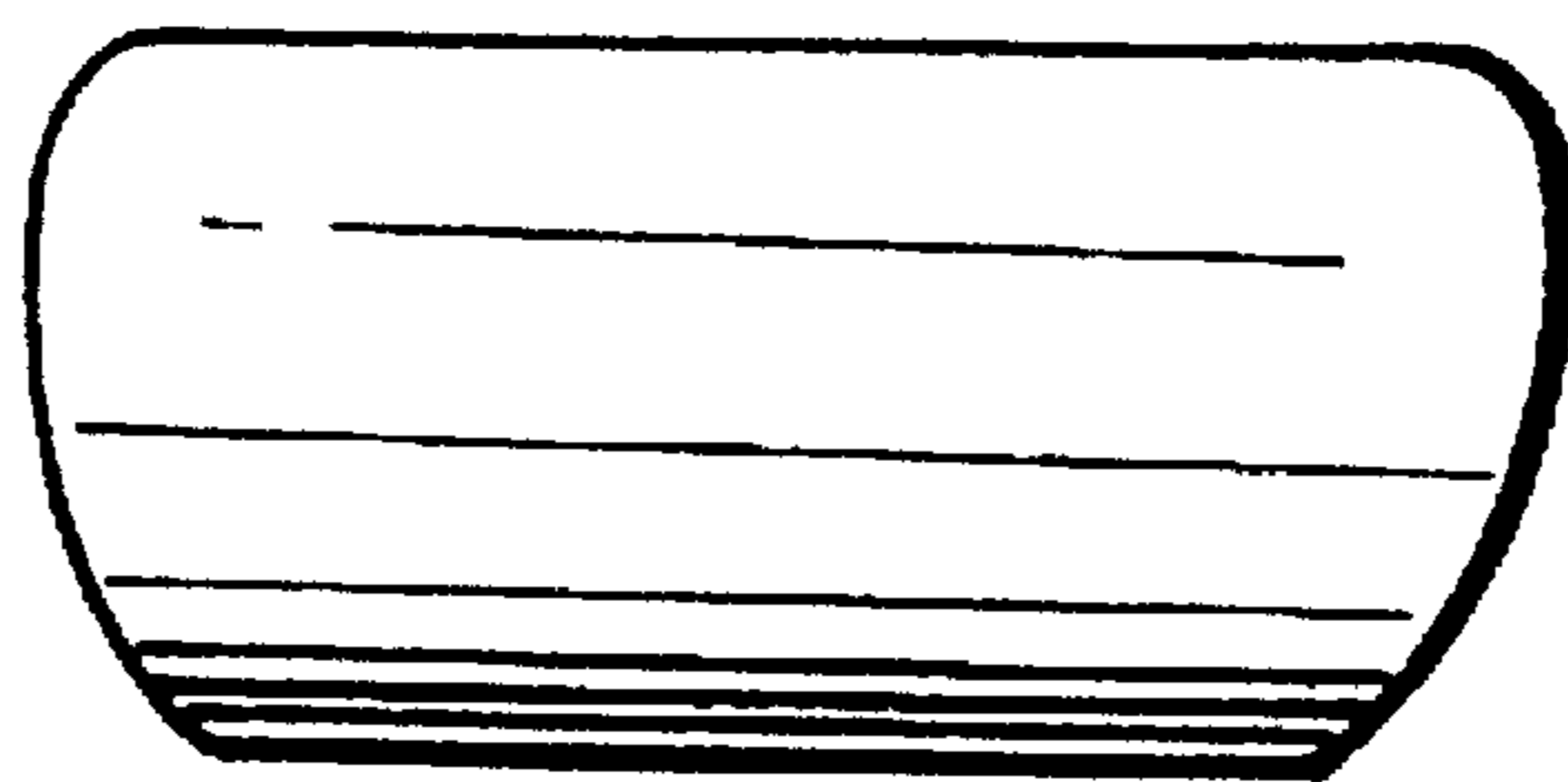
**FIG. 4**



**FIG. 5**



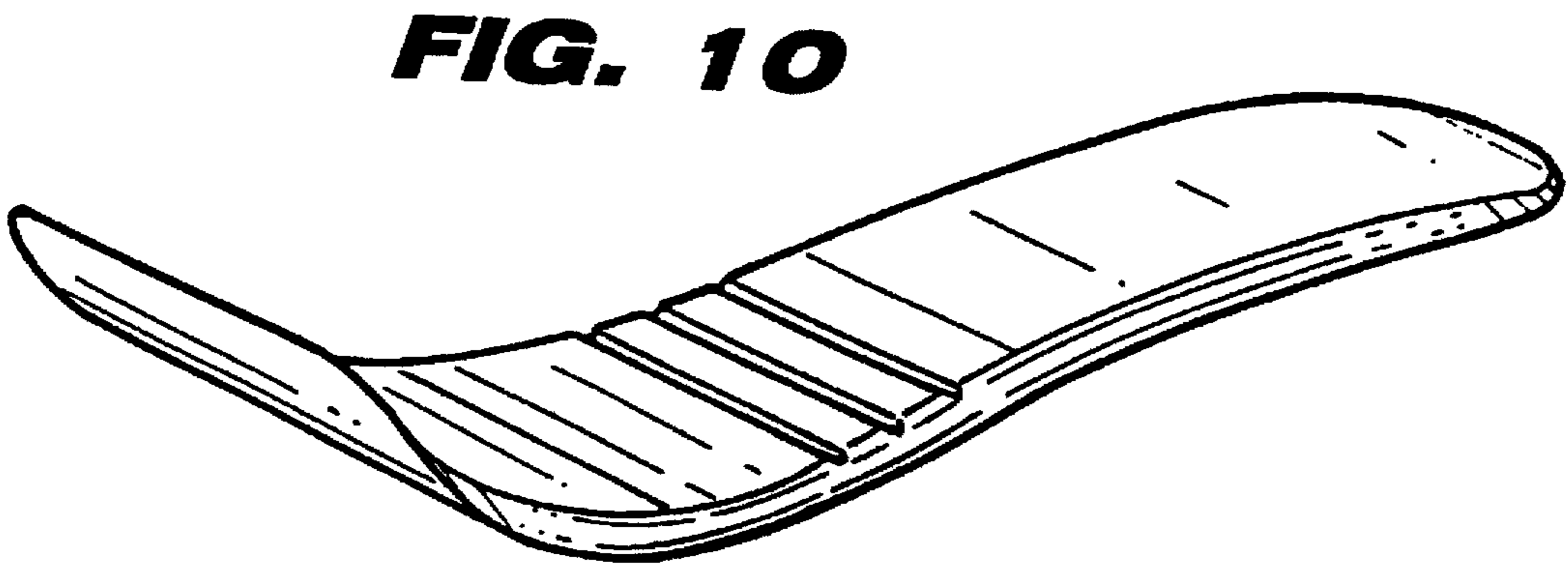
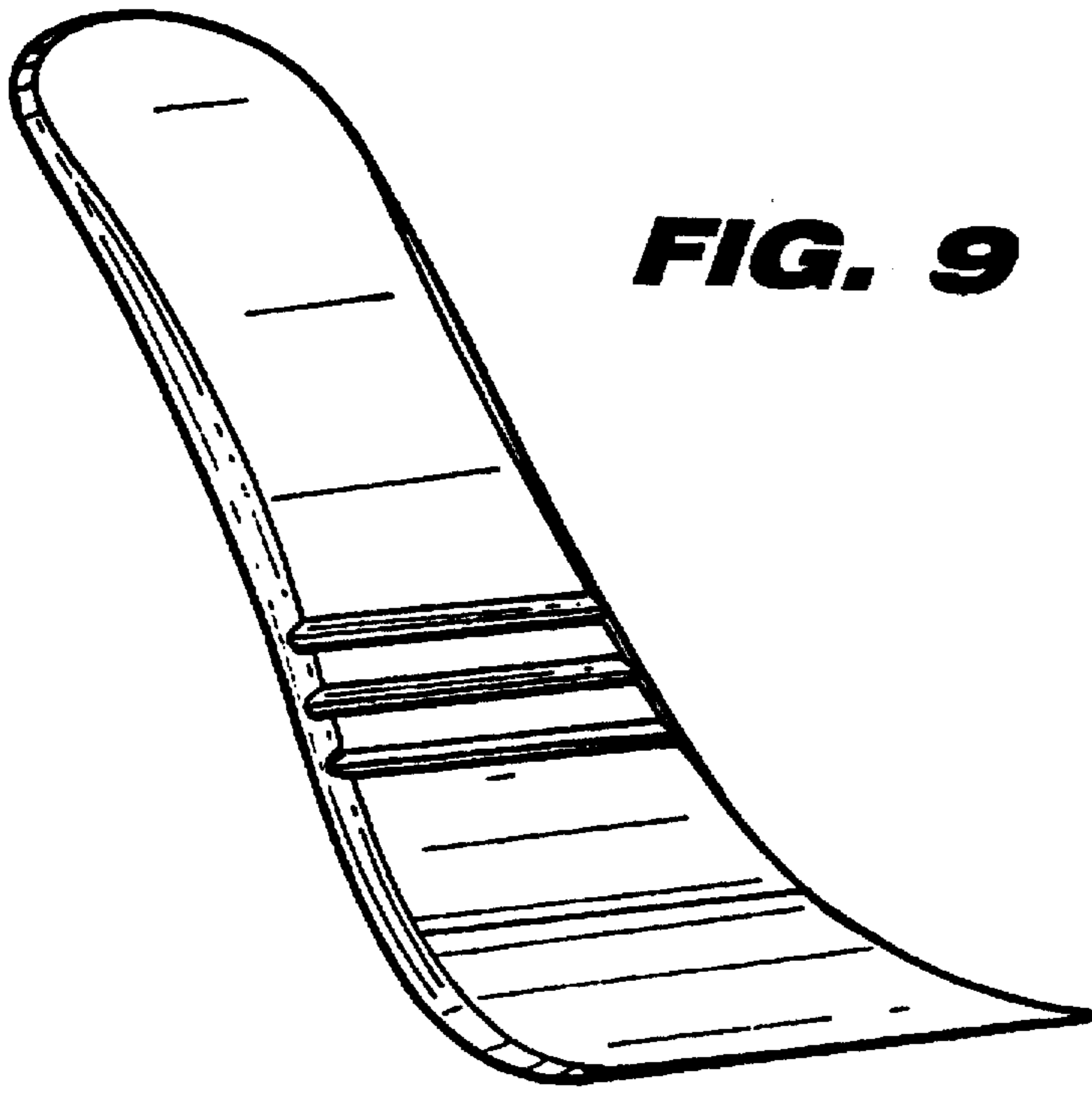
**FIG. 6**



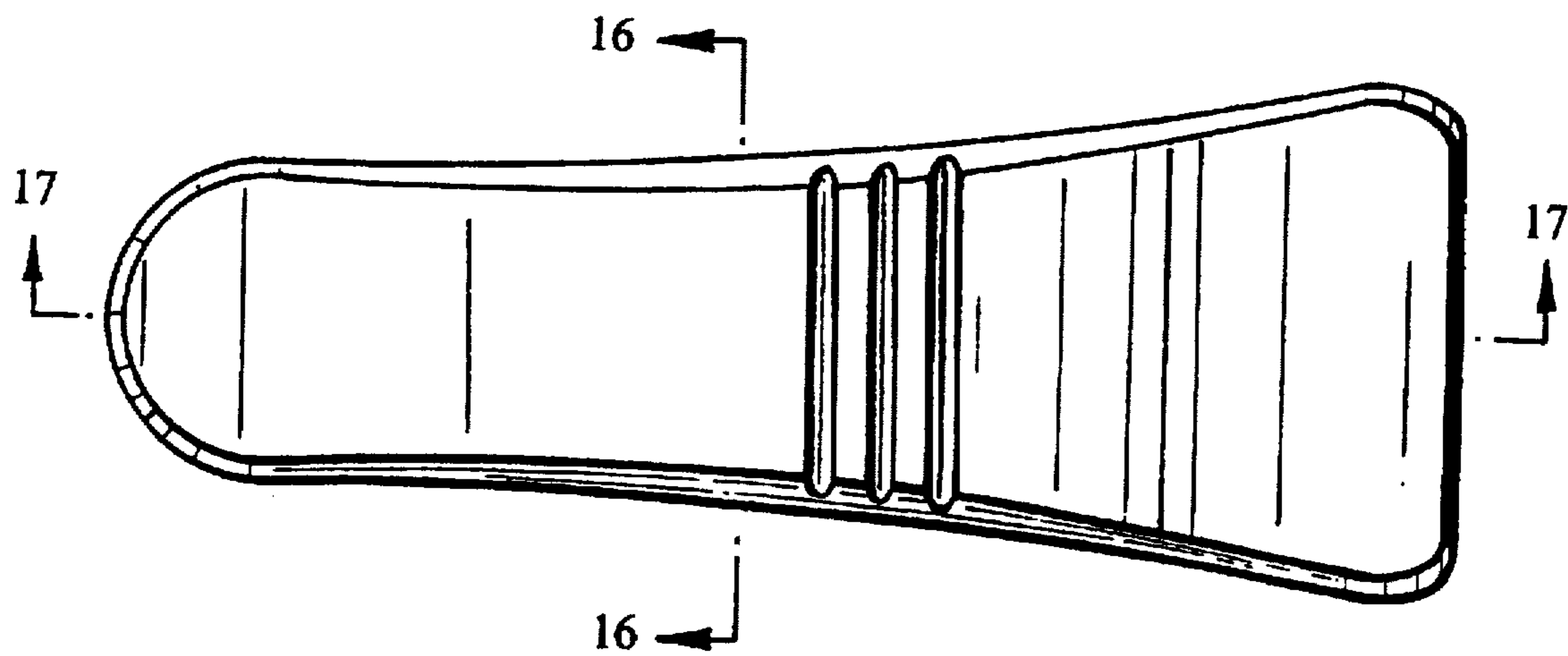
**FIG. 7**



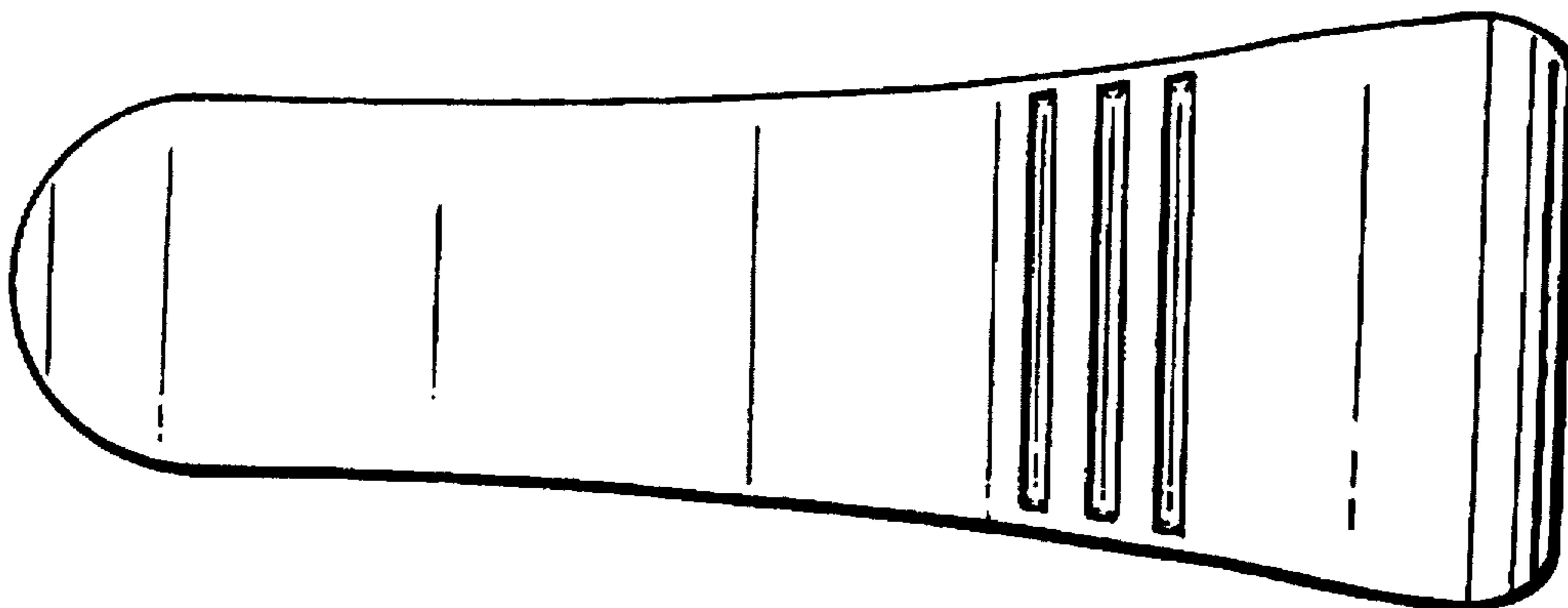
**FIG. 8**



**FIG. 11**



**FIG. 12**



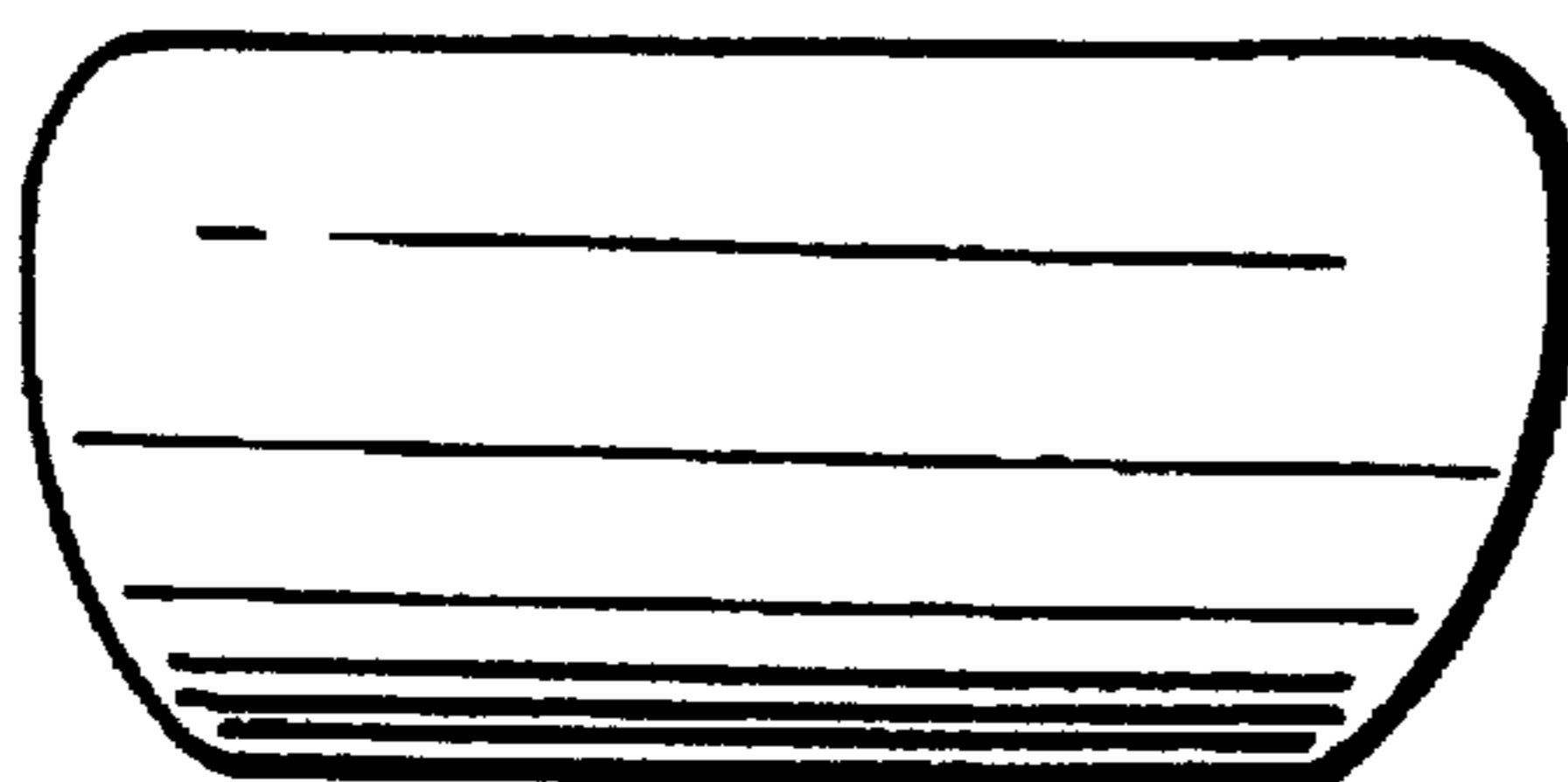
**FIG. 13**



**FIG. 14**



**FIG. 15**



**FIG. 16**



**FIG. 17**

