



US00D387564S

# United States Patent [19] Talbot

[11] Patent Number: **Des. 387,564**

[45] Date of Patent: **\*\*Dec. 16, 1997**

[54] **V SHAPED UTILITY BROOM**

[75] Inventor: **Neil E. Talbot, Patrick, Fla.**

[73] Assignee: **Neil Ellis Talbot, Layton, Utah**

[\*\*] Term: **14 Years**

[21] Appl. No.: **61,333**

[22] Filed: **Oct. 22, 1996**

[51] LOC (6) Cl. .... **04-01**

[52] U.S. Cl. .... **D4/135**

[58] Field of Search ..... D32/50, 51, 52;  
15/159.1, 160, 171, 173, 174, 175, 176.4;  
D4/130, 132, 135, 199

[56] **References Cited**

**U.S. PATENT DOCUMENTS**

- D. 132,113 4/1942 Clements ..... D4/135
- D. 152,843 2/1949 Wagner ..... D32/50

- D. 280,248 8/1985 Hanson, Jr. .... D32/50
- D. 293,165 12/1987 Machacek ..... D32/50 X
- D. 343,298 1/1994 Joyner ..... D4/199
- 3,224,025 12/1965 Altroch .
- 4,791,695 12/1988 Kephart ..... D4/130 X
- 5,625,918 5/1997 Kieson et al. .... 15/144.4

*Primary Examiner*—Susan J. Lucas  
*Assistant Examiner*—Cynthia E. Ramirez

[57] **CLAIM**

The ornamental design for a V shaped utility broom, as shown.

**DESCRIPTION**

FIG. 1 is a rear view;  
FIG. 2 is a perspective view;  
FIG. 3 is a side view; and,  
FIG. 4 is a front view.

**1 Claim, 4 Drawing Sheets**

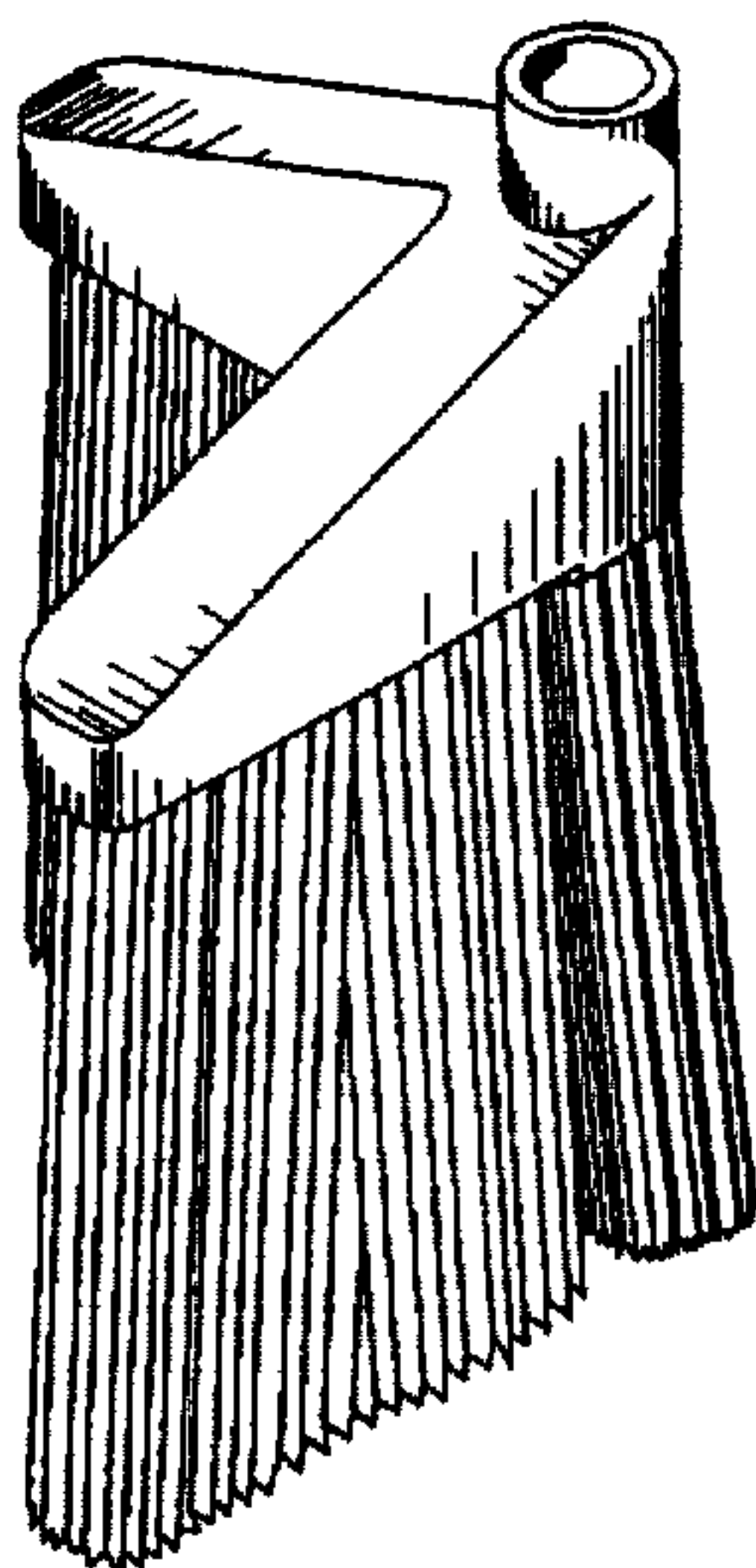
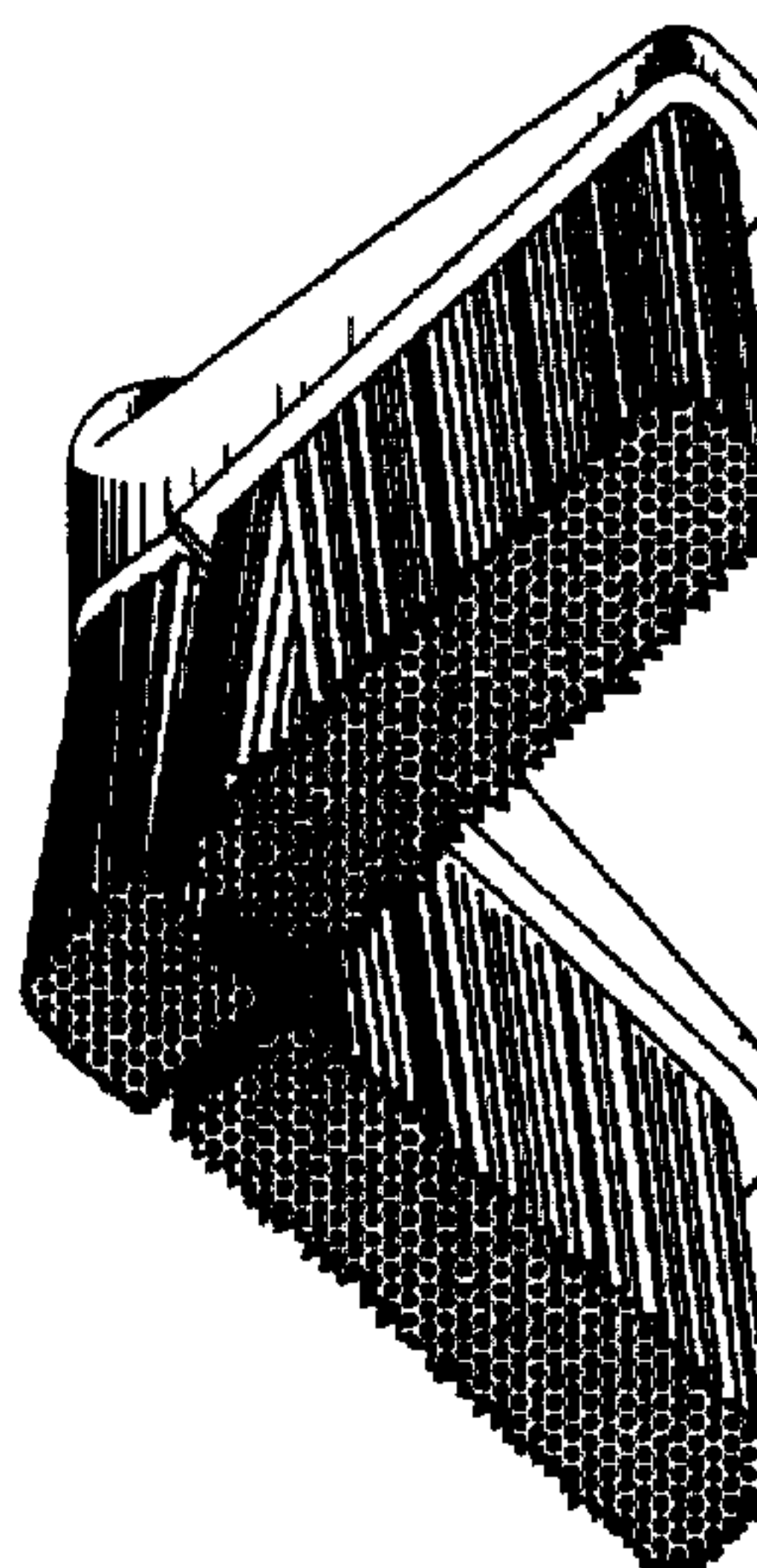
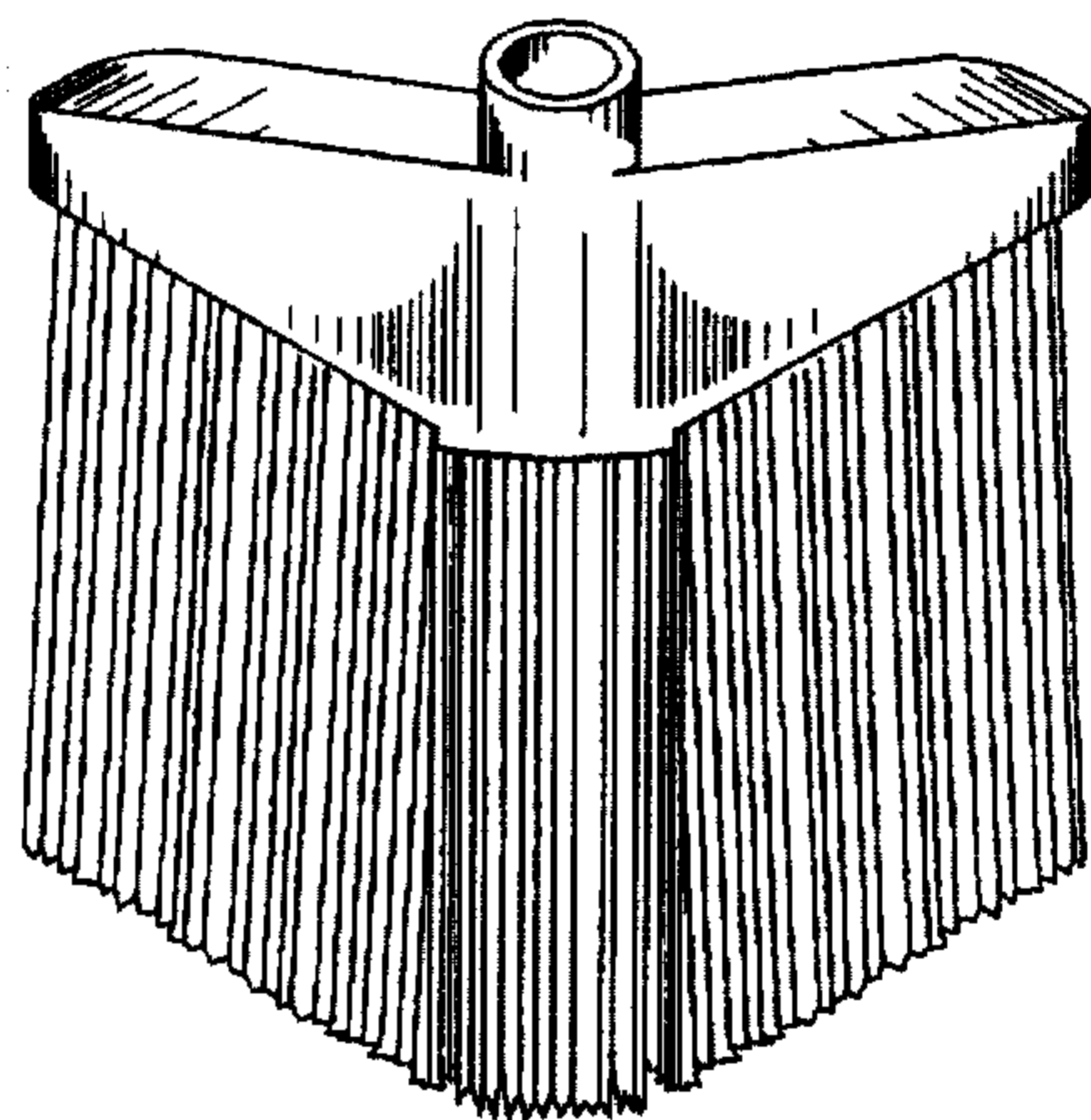

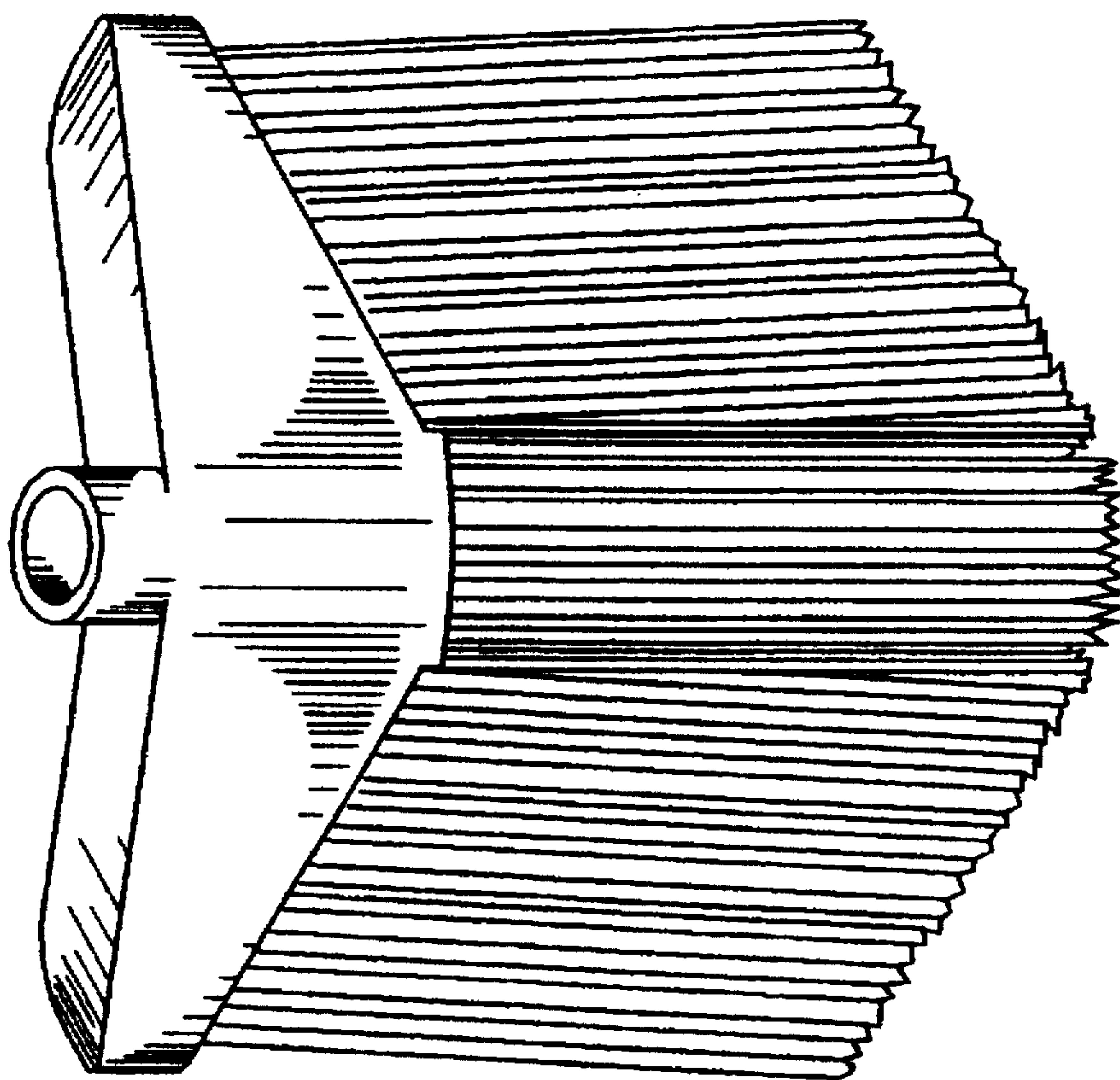

FIG.1

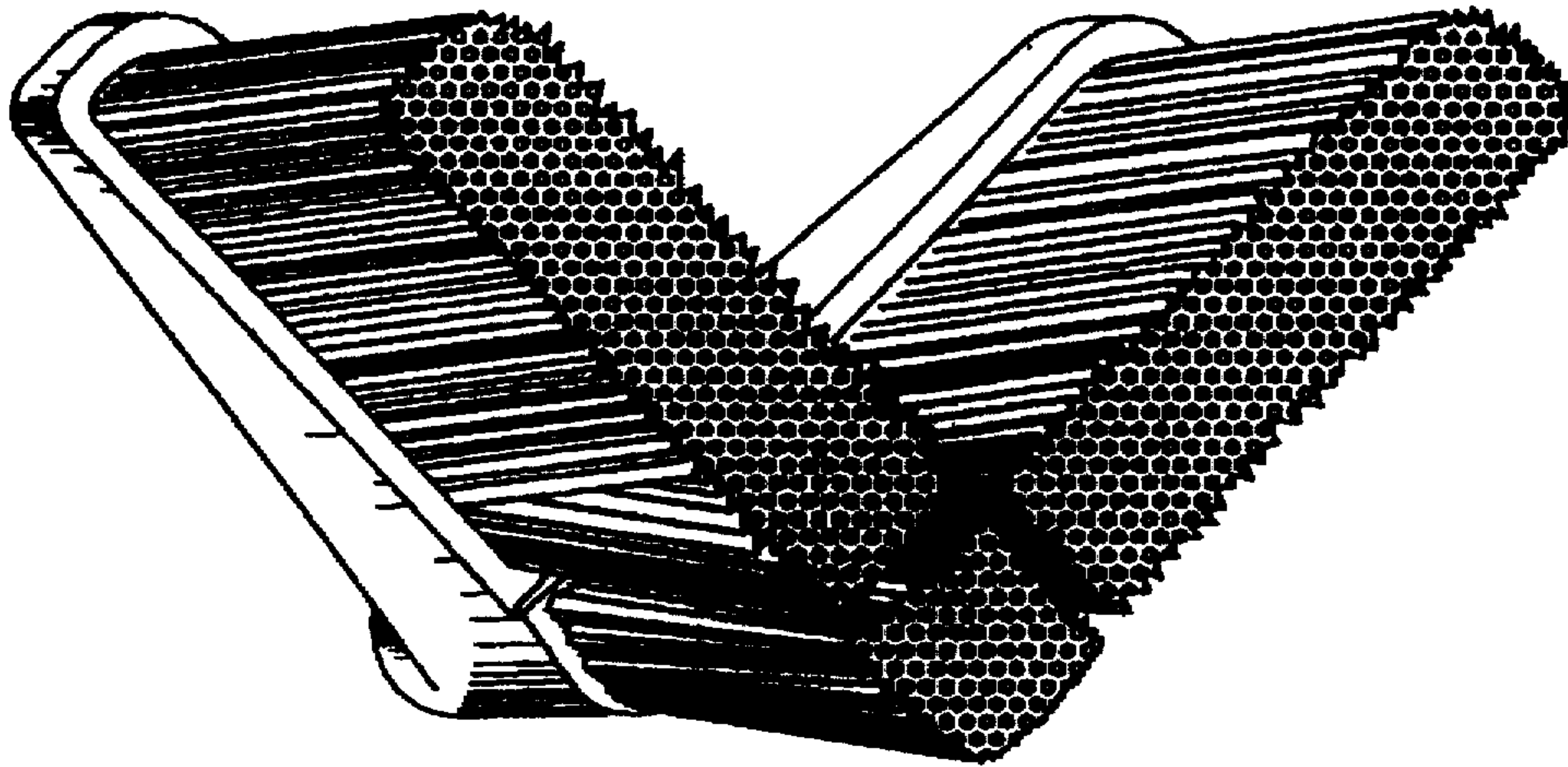

FIG. 2

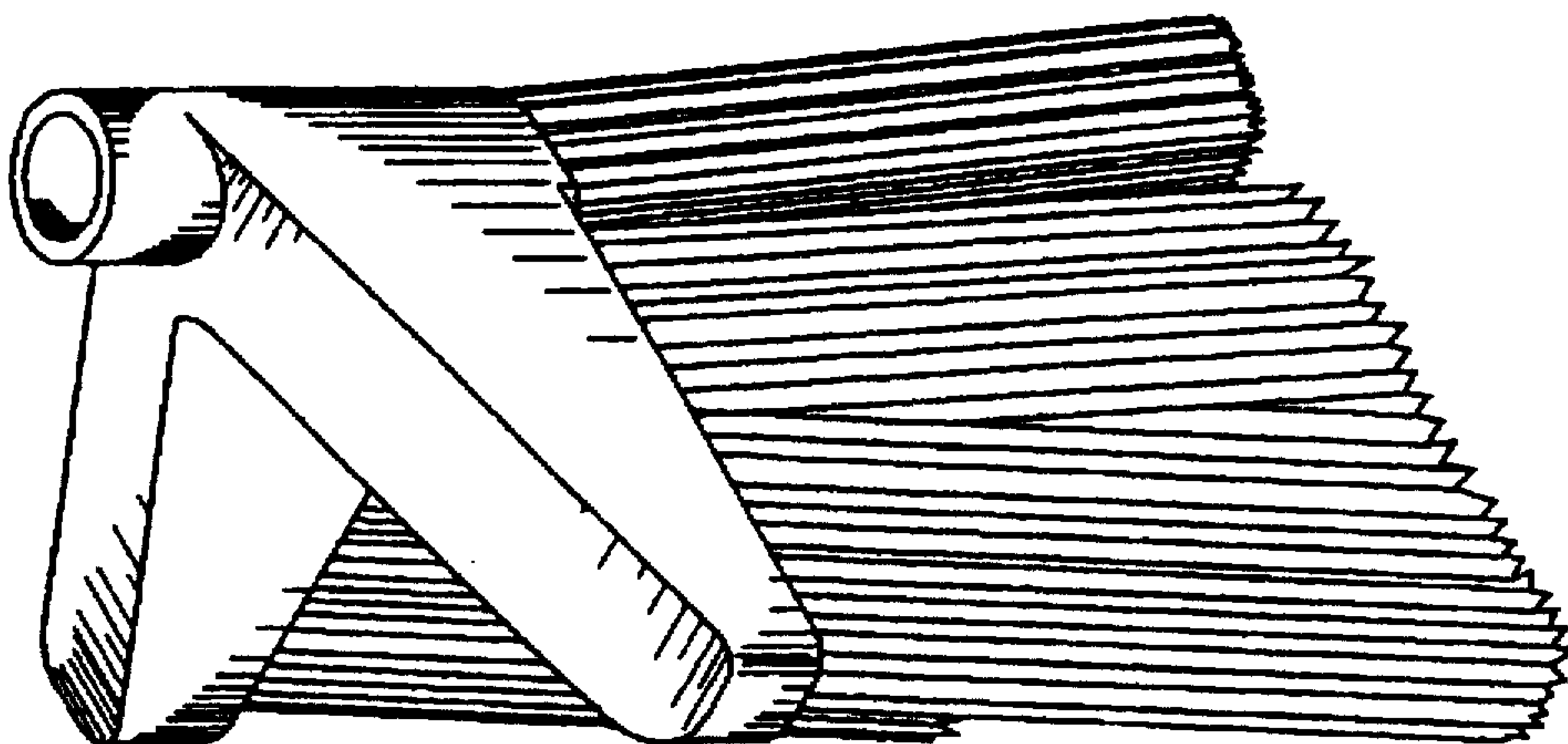

FIG. 3

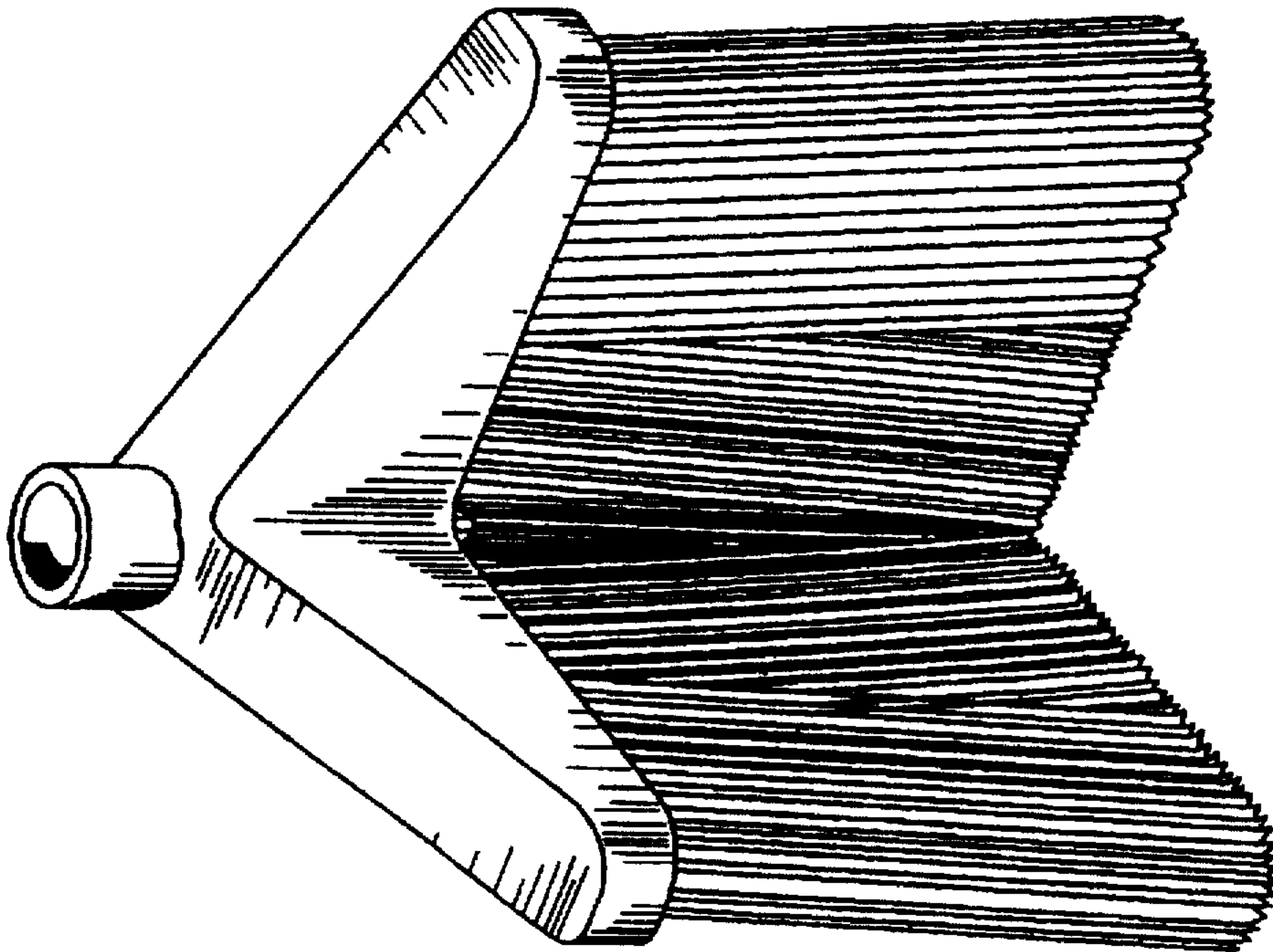

FIG. 4