



US00D387529S

United States Patent [19] Spitaler

[11] Patent Number: **Des. 387,529**

[45] Date of Patent: ****Dec. 9, 1997**

[54] **GARBAGE CAN**

[75] Inventor: **Peter Spitaler**, Vienna, Australia

[73] Assignee: **Witzmann Plastik Vertriebs GmbH**,
GreuBenheim, Germany

[**] Term: **14 Years**

[21] Appl. No.: **49,481**

[22] Filed: **Jan. 26, 1996**

[51] LOC (6) CL **09-09**

[52] U.S. Cl. **D34/1; D34/5**

[58] Field of Search **D34/1, 5-7; D32/37;**
220/908, 909, 403, 404, 409, 23.4

[56] **References Cited**

U.S. PATENT DOCUMENTS

D. 327,756	7/1992	Klein et al.	D34/1
4,139,114	2/1979	Long et al.	220/23.4
5,005,727	4/1991	Roth	220/404
5,101,997	4/1992	Bagwell et al.	220/23.4
5,139,299	8/1992	Smith	294/159
5,392,916	2/1995	Paulison	220/909

FOREIGN PATENT DOCUMENTS

8900980	1/1989	Germany .
9102154	2/1991	Germany .
9102304	4/1991	Germany .

Primary Examiner—Alan P. Douglas
Assistant Examiner—Robin V. Taylor
Attorney, Agent, or Firm—Oppenheimer Poms Smith

[57] **CLAIM**

The ornamental design for a garbage can, as shown and described.

DESCRIPTION

FIG. 1 is a perspective view of the garbage can in accordance with the teachings of the invention;

FIG. 2 is a side elevational view of the garbage can of FIG. 1;

FIG. 3 is a front elevational view of the garbage can of FIG. 1;

FIG. 4 is a rear elevational view of the garbage can FIG. 1; FIG. 5 is an elevational view of the other side of the garbage can of FIG. 1;

FIG. 6 is a bottom plan view of the garbage can of FIG. 1; FIG. 7 is a top plan view of the garbage can of FIG. 1;

FIG. 8 is a perspective view of the garbage can of FIG. 1 with three of the separable containers removed therefrom;

FIG. 9 is a front, side perspective view of one of the separable containers with the handle and lid in open position thereof; shown separately for clarity of illustration;

FIG. 10 is a front perspective view of a second separable container with the lid in open position thereof, shown separately for clarity of illustration; and,

FIG. 11 is a side, front perspective view of a third separable container thereof with the lid closed.

1 Claim, 8 Drawing Sheets

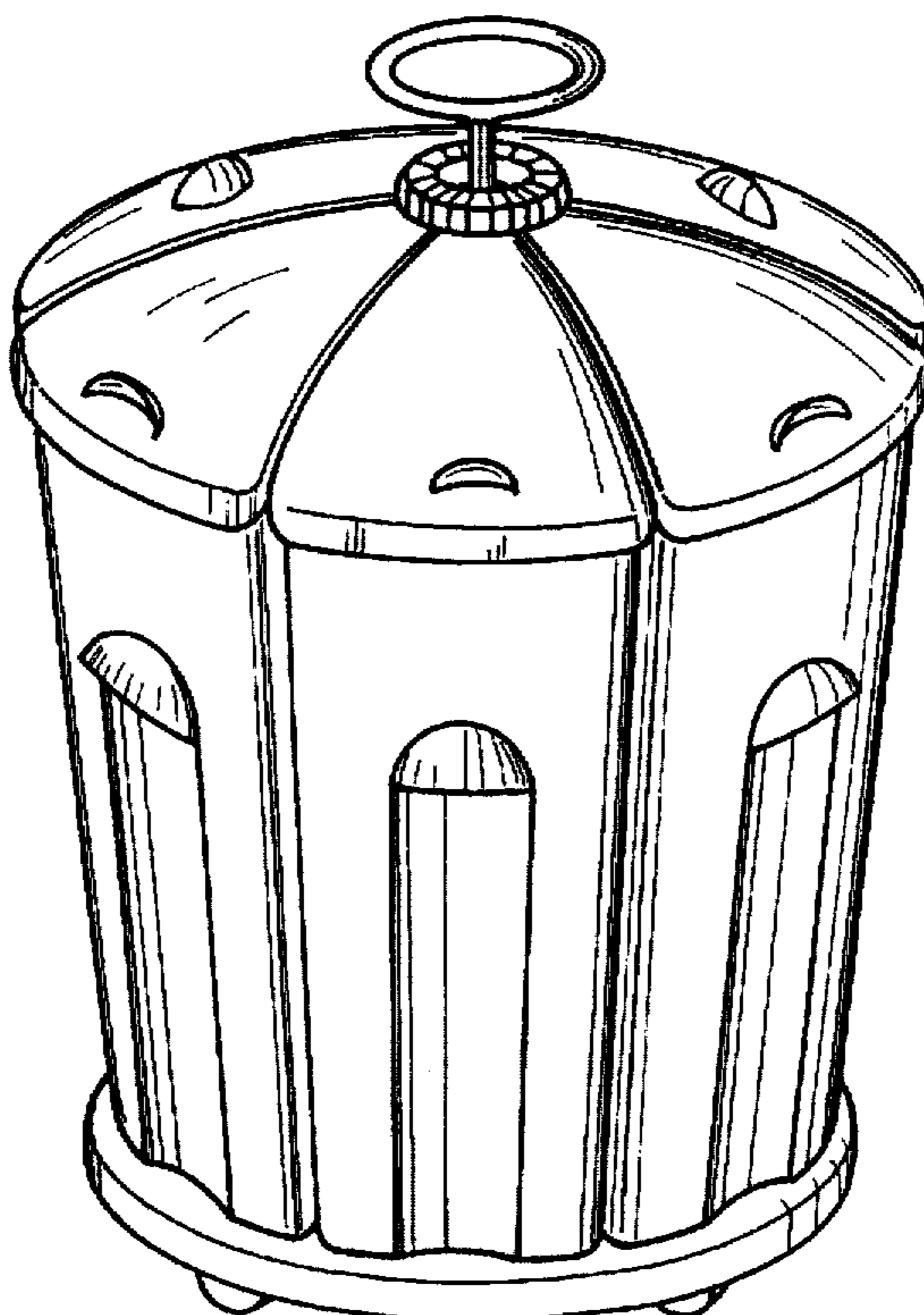

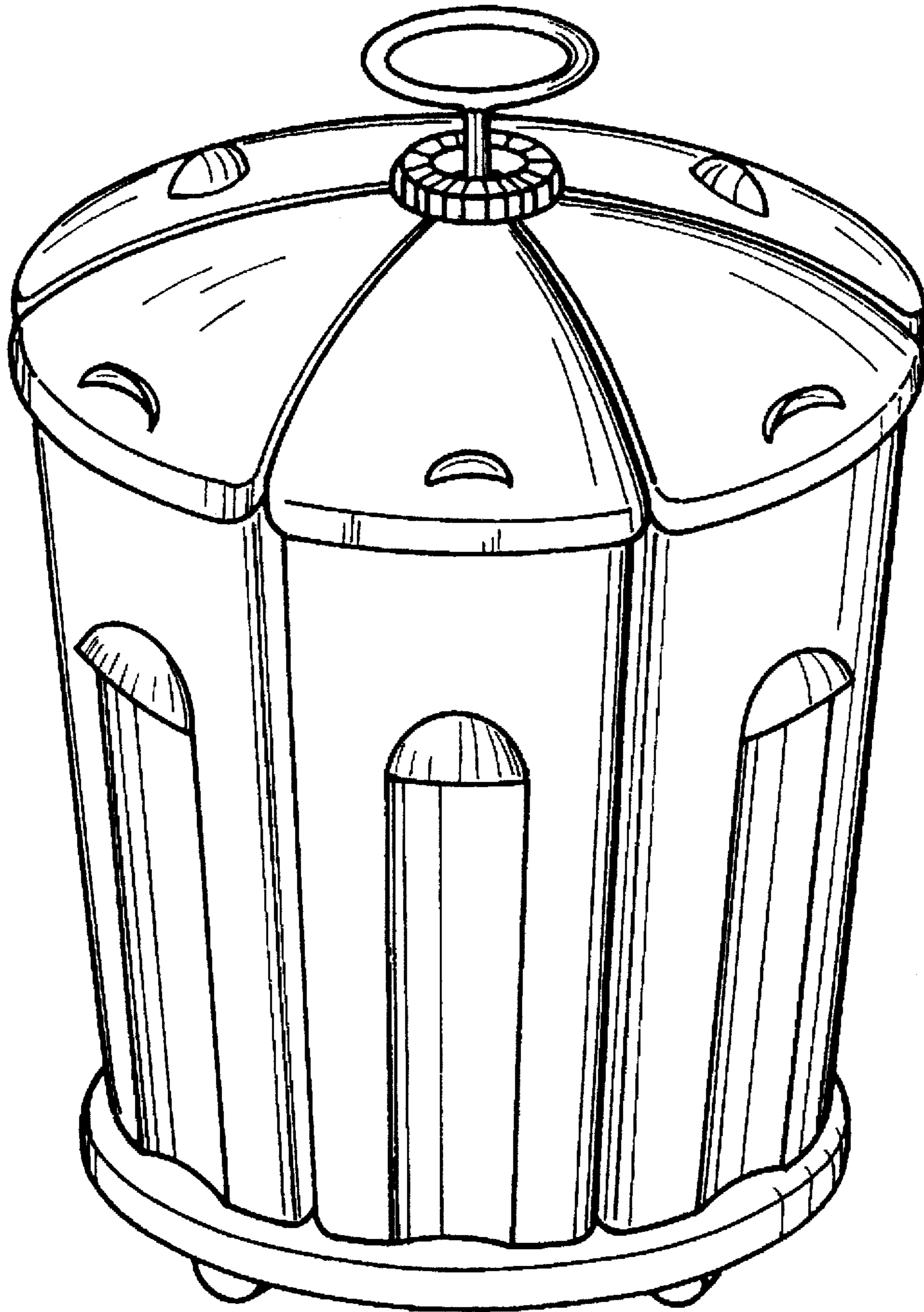

Fig. 1

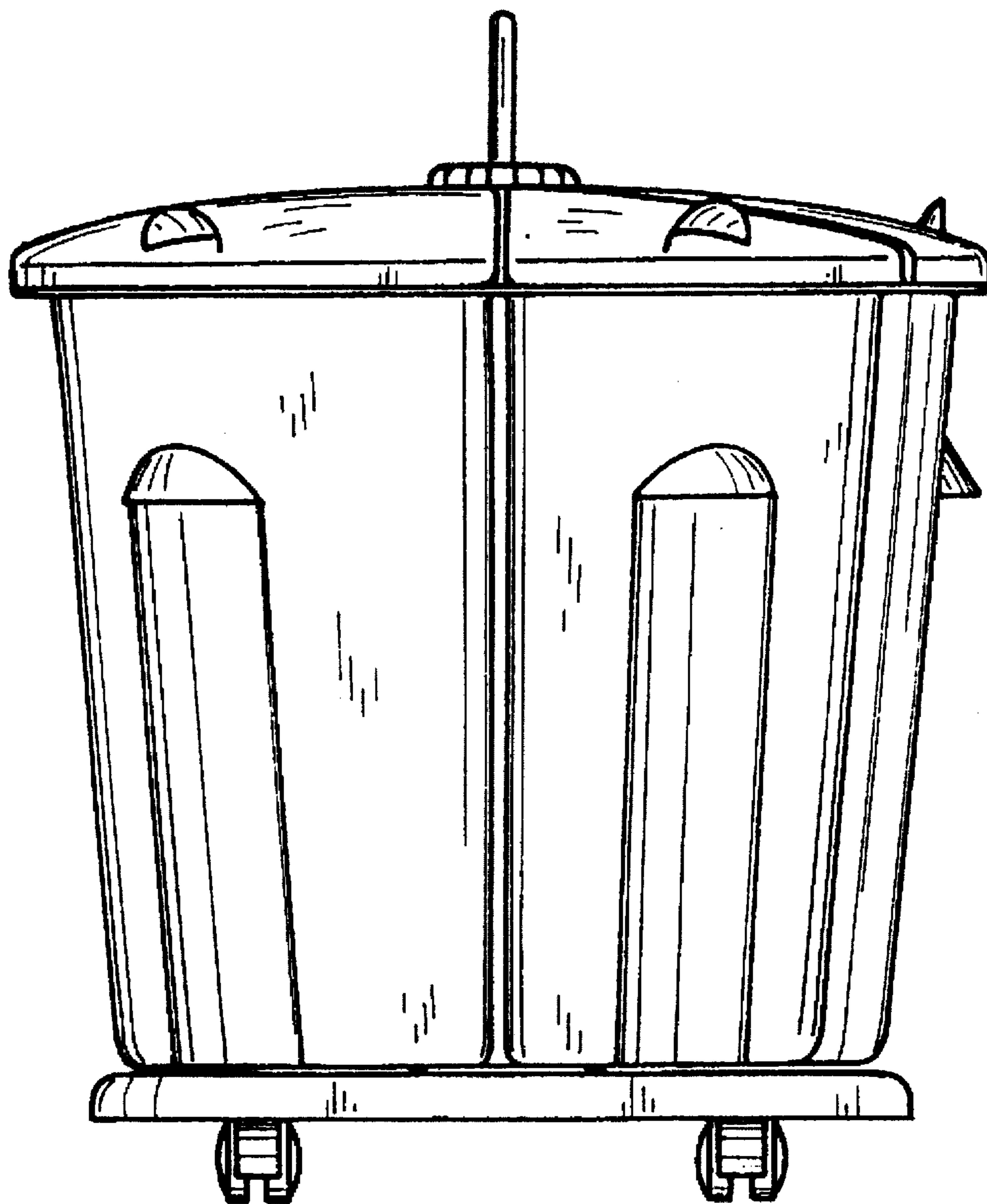

Fig. 2

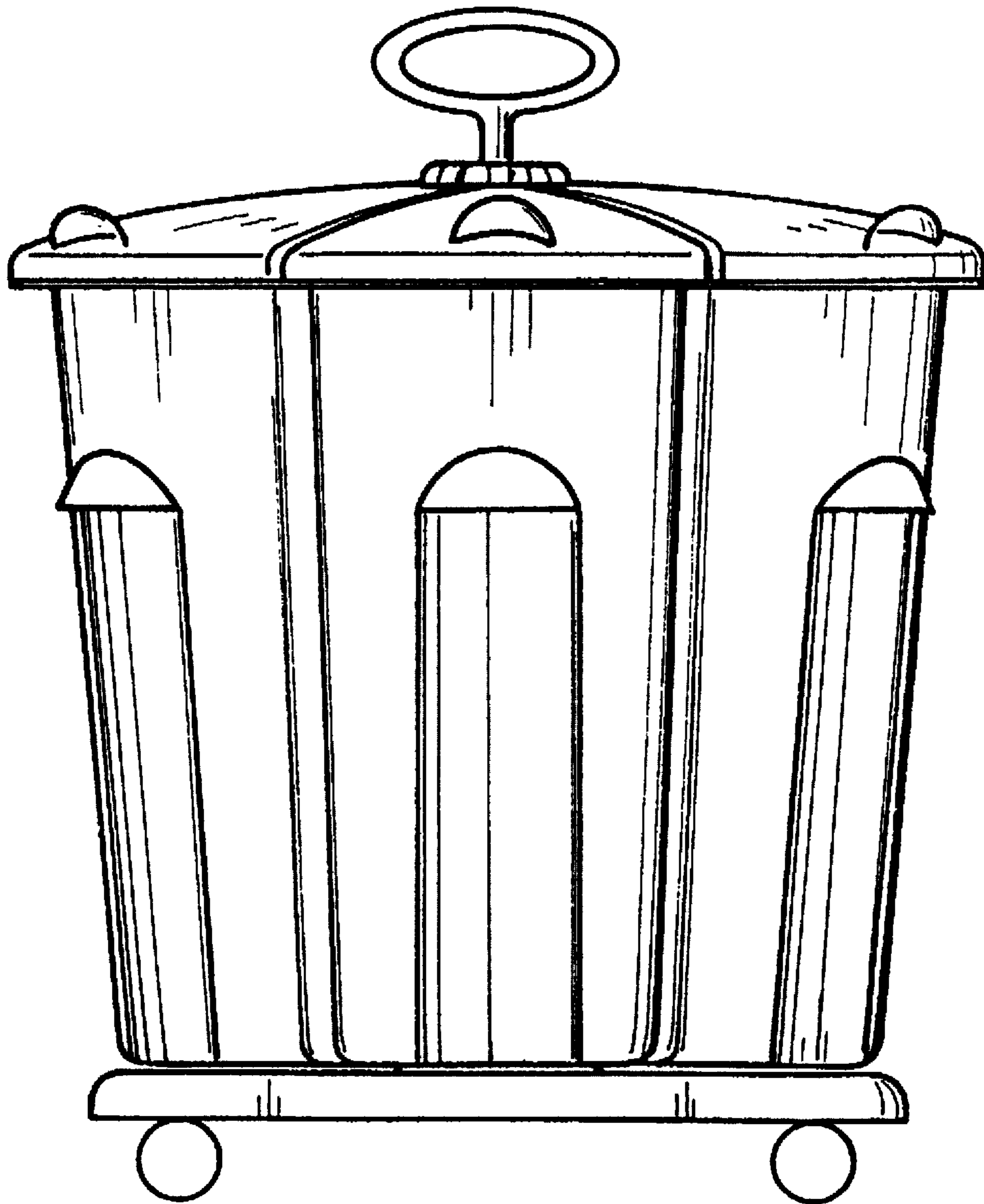

Fig. 3

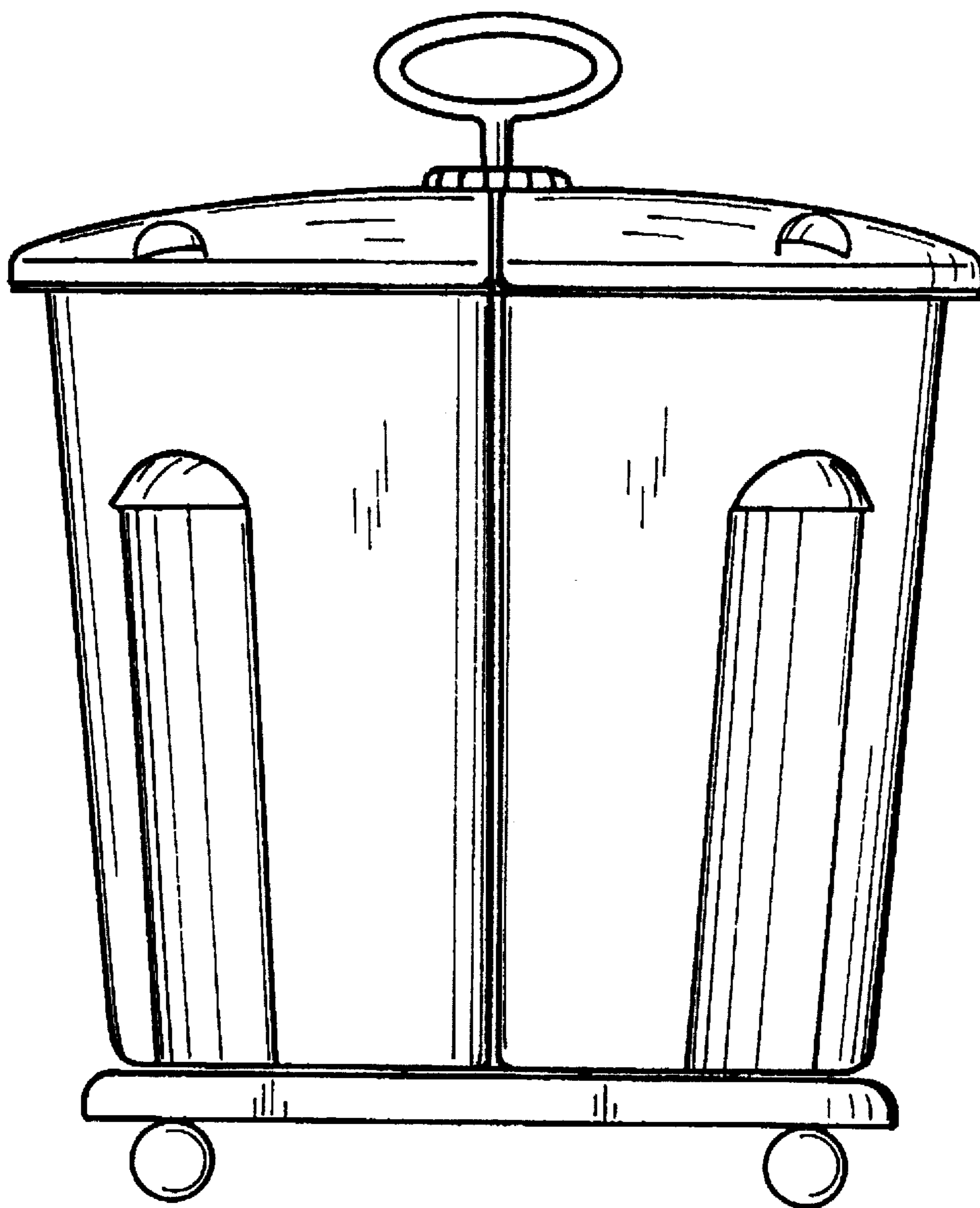

Fig. 4

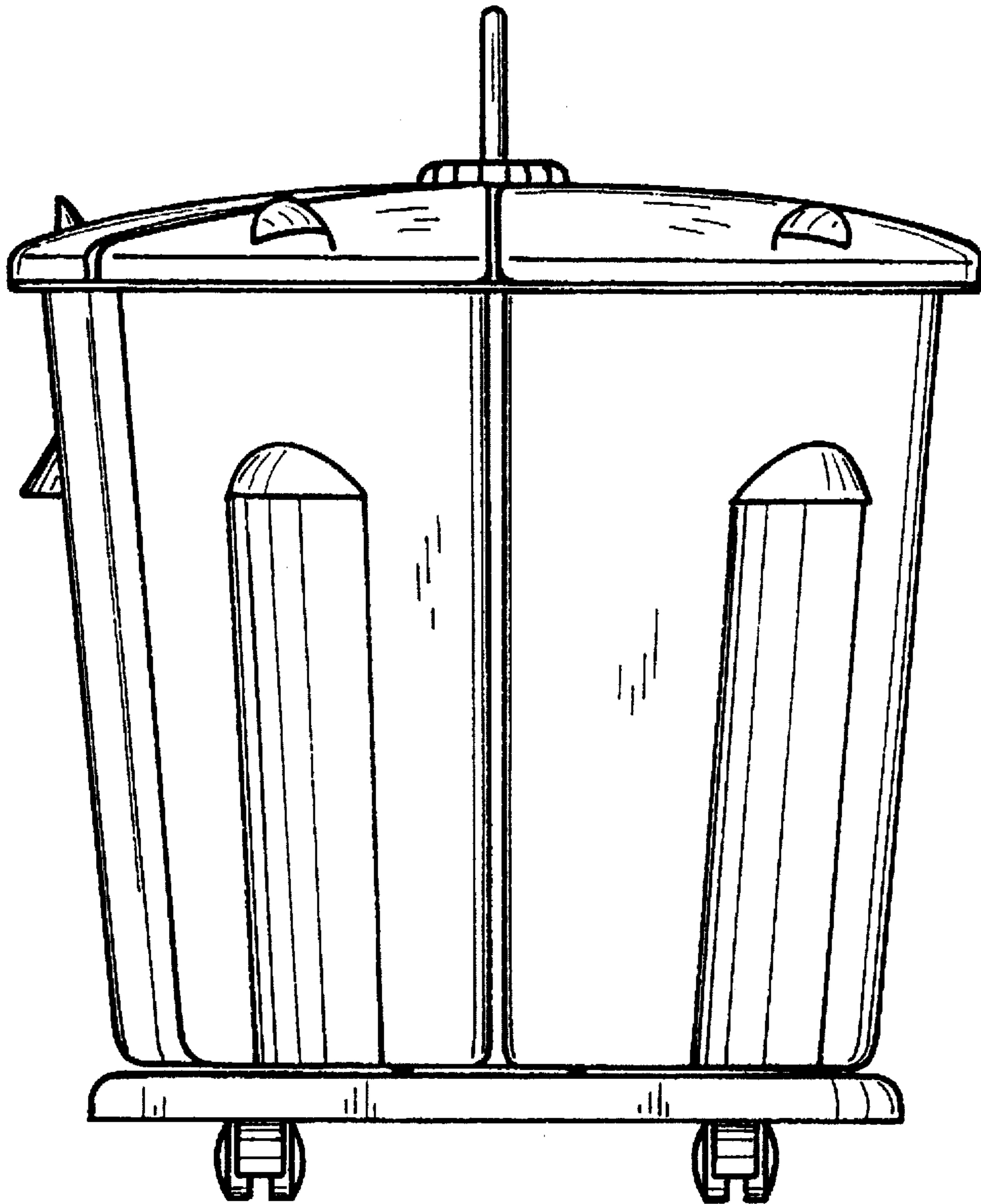

Fig. 5

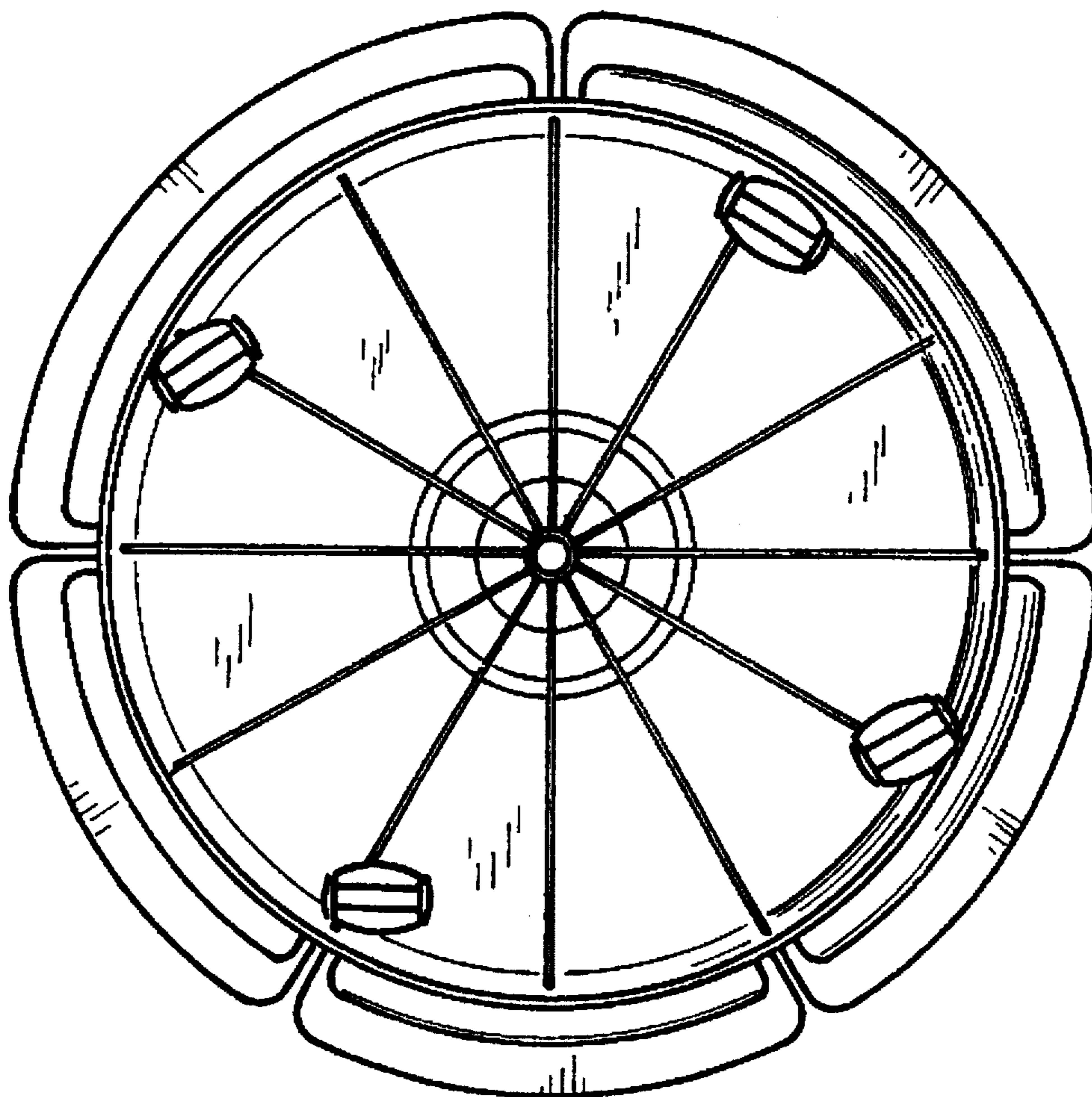

Fig. 6

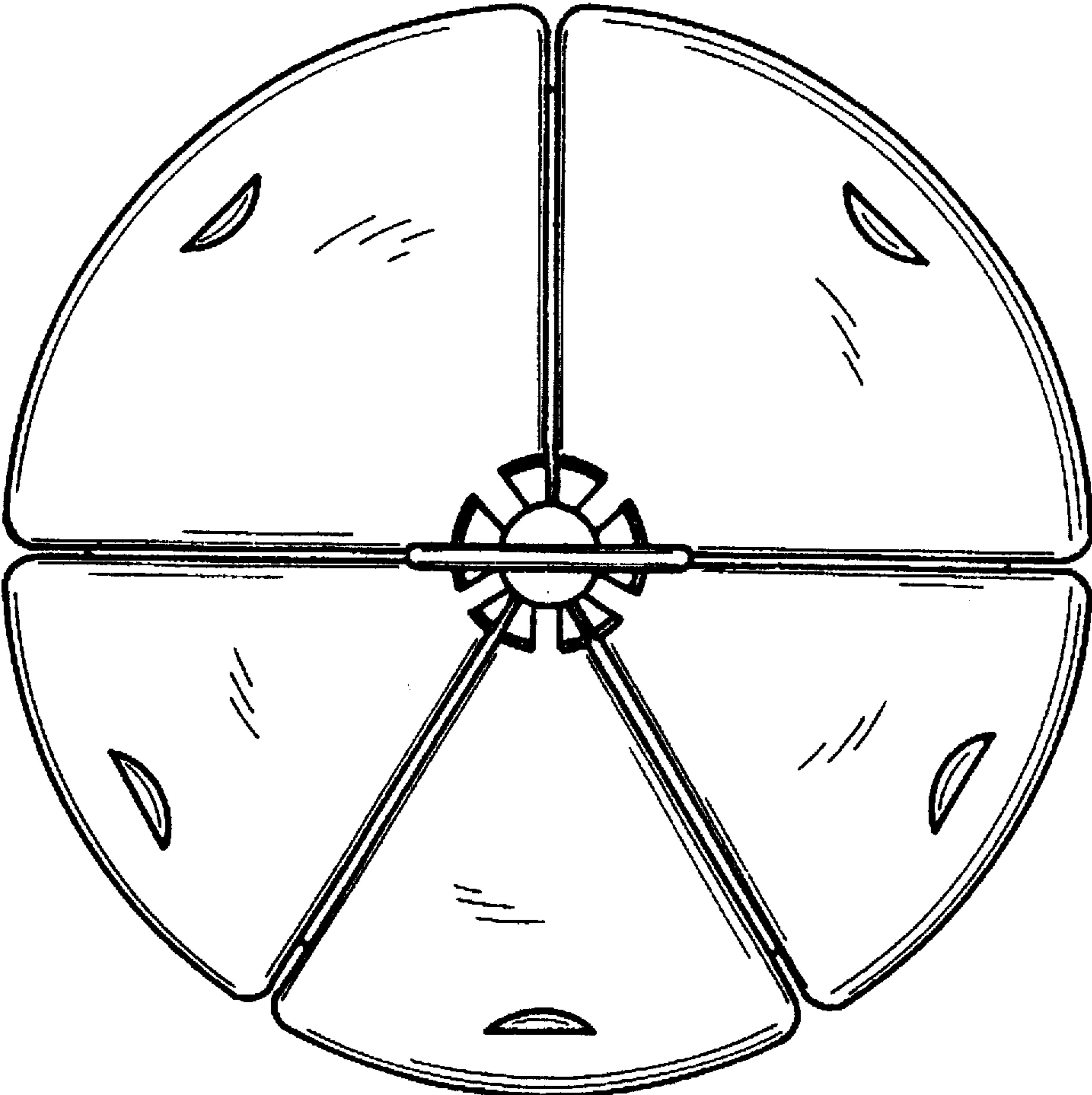

Fig. 7

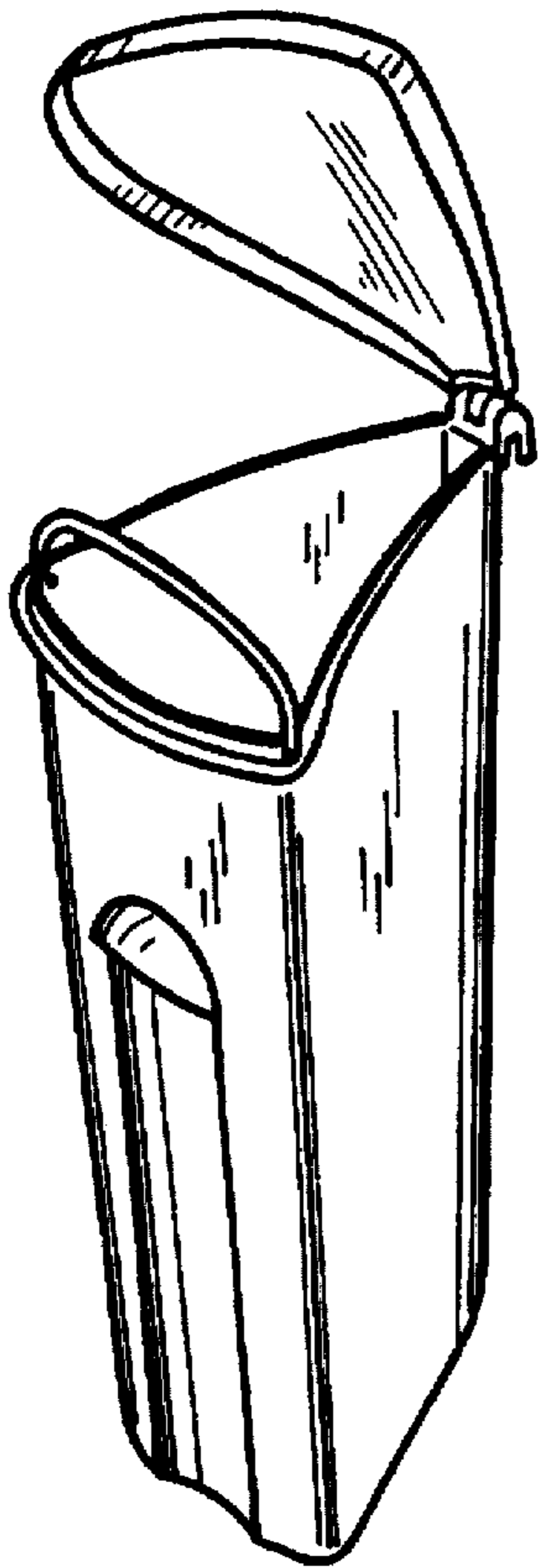

Fig. 9

Fig. 10

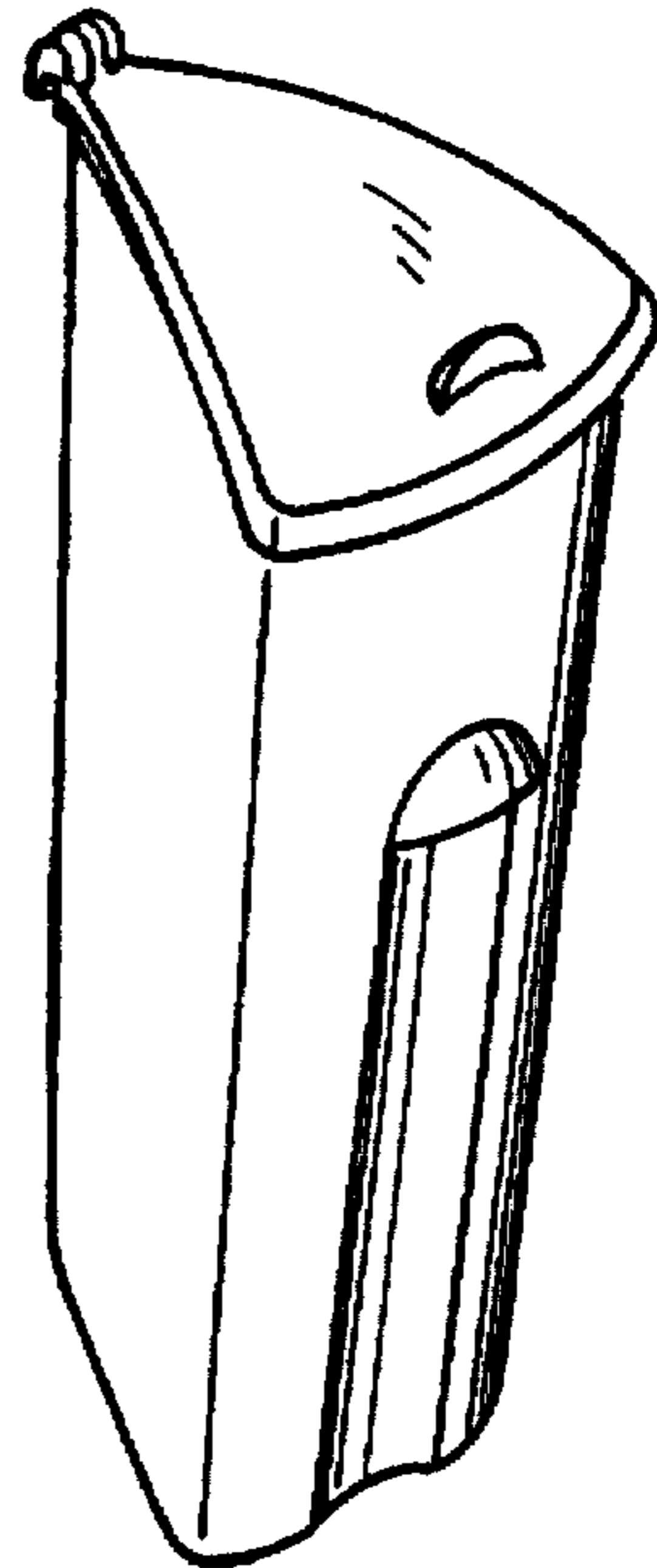
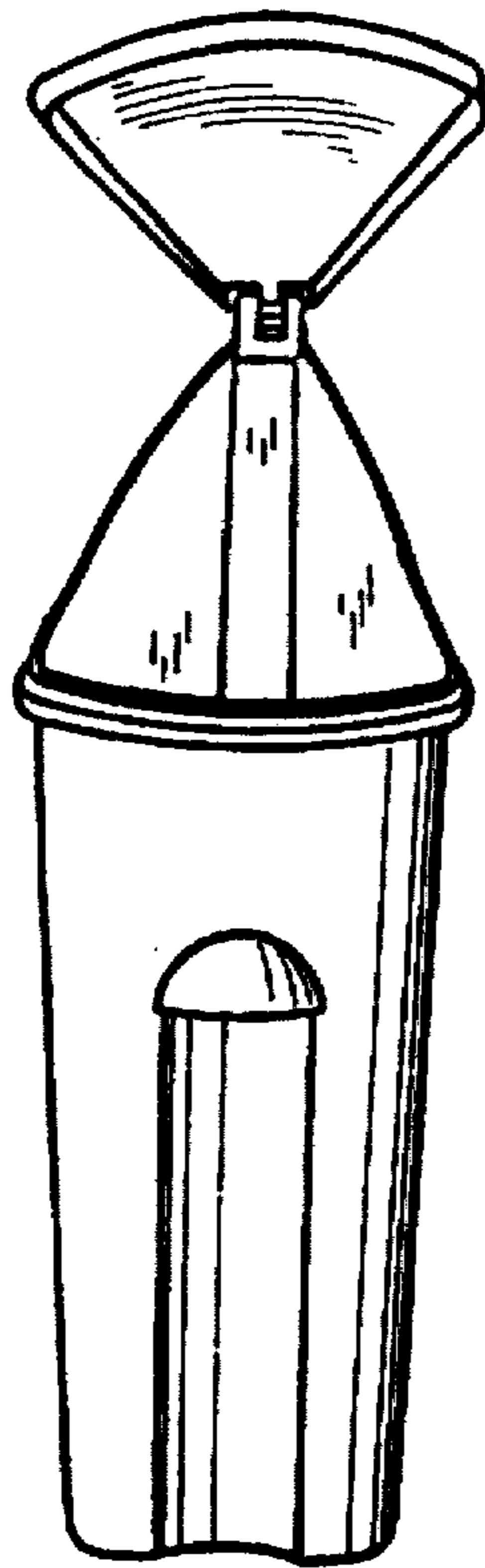

Fig. 11

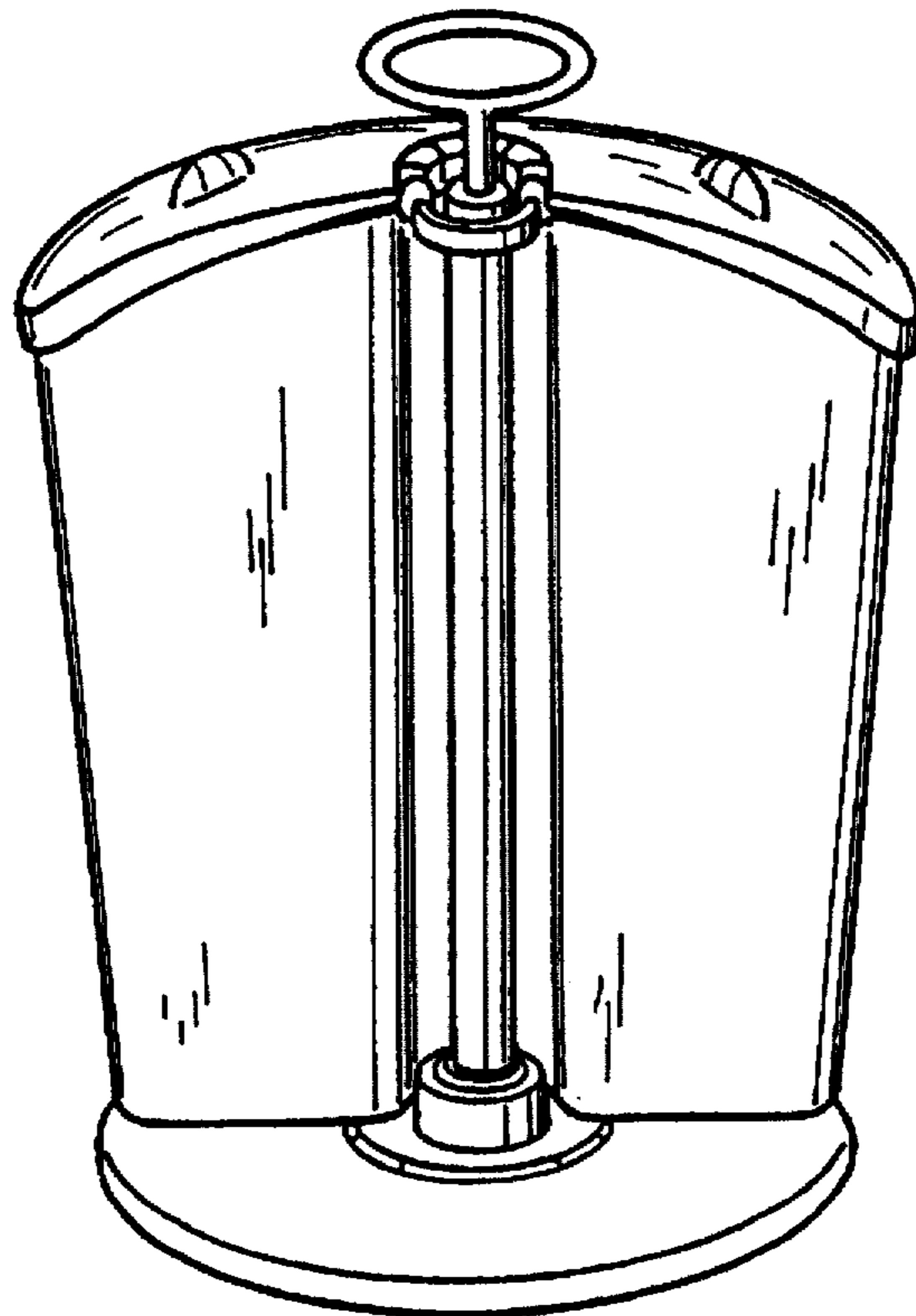

Fig. 8

UNITED STATES PATENT AND TRADEMARK OFFICE
CERTIFICATE OF CORRECTION

PATENT NO. : D387,529
DATED : December 9, 1997
INVENTOR(S) : Peter Spitaler

It is certified that error appears in the above-identified patent and that said Letters Patent is hereby corrected as shown below:

On the title page, item [75]
"Inventor," "Australia" should be --Austria--.

Signed and Sealed this
Tenth Day of March, 1998

Attest:



BRUCE LEHMAN

Attesting Officer

Commissioner of Patents and Trademarks

UNITED STATES PATENT AND TRADEMARK OFFICE
CERTIFICATE OF CORRECTION

PATENT NO. : Des. 387,529
DATED : December 9, 1997
INVENTOR(S) : Peter Spitaler

It is certified that error appears in the above-identified patent and that said Letters Patent is hereby corrected as shown below:

On the title page, item [30], add:

Jul. 27, 1995 [DE] Fed. Rep. of Germany . . . M 95 06 144.4

Signed and Sealed this
Sixth Day of April, 1999

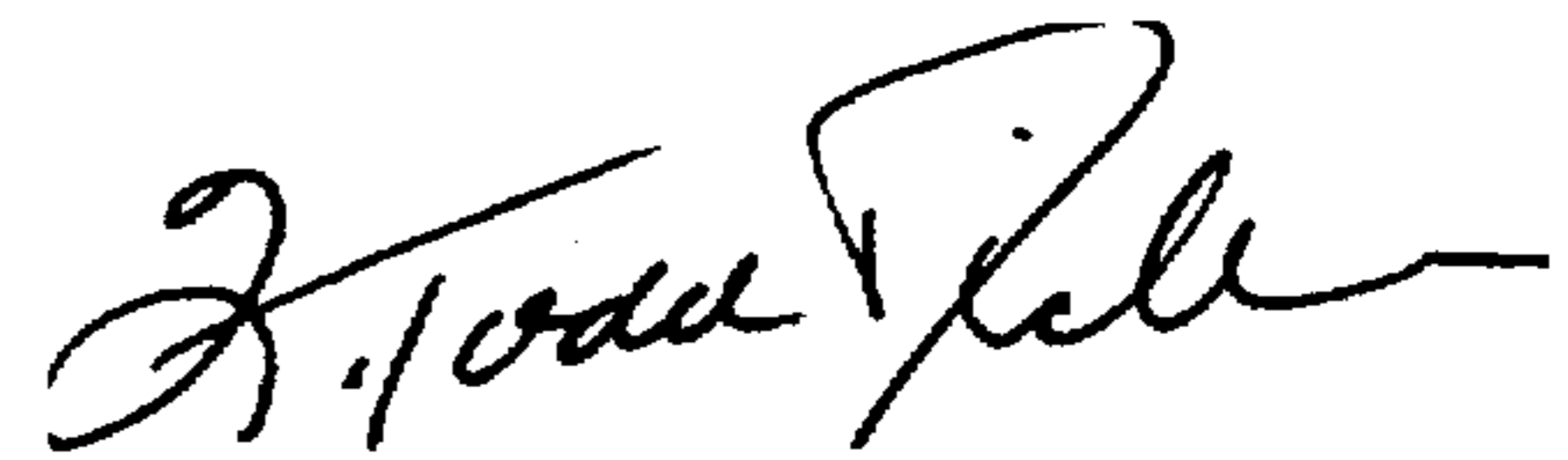

Q. TODD DICKINSON

Acting Commissioner of Patents and Trademarks

Attest:

Attesting Officer