



US00D387503S

United States Patent [19] Ho

[11] Patent Number: **Des. 387,503**

[45] Date of Patent: ****Dec. 9, 1997**

[54] **WEIGHTED GLOVE**

[76] Inventor: **Chiu-Hsiang Ho**, 1F, No. 98, Alley 59,
Lane 437, Chen Hsin Road, Taichung,
Taiwan

[**] Term: **14 Years**

[21] Appl. No.: **58,195**

[22] Filed: **Aug. 6, 1996**

[51] LOC (6) CL **29-02**

[52] U.S. CL **D29/113; D2/610**

[58] Field of Search D2/610, 612, 614,
D2/616, 617, 621; 2/159, 161.1, 161.2,
161.4, 161.5, 162; D29/100, 113, 117, 120,
122, 123

[56] **References Cited**

U.S. PATENT DOCUMENTS

D. 236,043	7/1975	Carter	D29/113
D. 251,337	3/1979	Coon	D29/113
D. 266,288	9/1982	Coon	D29/113
D. 295,897	5/1988	Thimm-Kelly	D29/113 X
1,200,580	10/1916	Brenner	D29/113 X
4,228,548	10/1980	Cohen	D29/113 X

4,546,495	10/1985	Castillo	2/161.1
4,556,215	12/1985	Tarbox et al.	2/161.1 X
4,575,075	3/1986	Tarbox et al.	2/161.1 X
5,459,883	10/1995	Garceau-Ver Beck	2/161.1

Primary Examiner—Paula A. Mortimer
Attorney, Agent, or Firm—Browdy and Neimark

[57] **CLAIM**

The ornamental design for a "weighted glove", as shown and described.

DESCRIPTION

FIG. 1 is a perspective view of a weighted glove showing my new design;

FIG. 2 is a front elevational view thereof;

FIG. 3 is a rear elevational view thereof;

FIG. 4 is a left end elevational view thereof;

FIG. 5 is a right end elevational view thereof;

FIG. 6 is a top plan view thereof;

FIG. 7 is a bottom plan view thereof; and,

FIG. 8 is a perspective view thereof.

The broken line showing of the human form in FIG. 8 is for illustrative purposes only and forms no part of the claimed design.

1 Claim, 3 Drawing Sheets

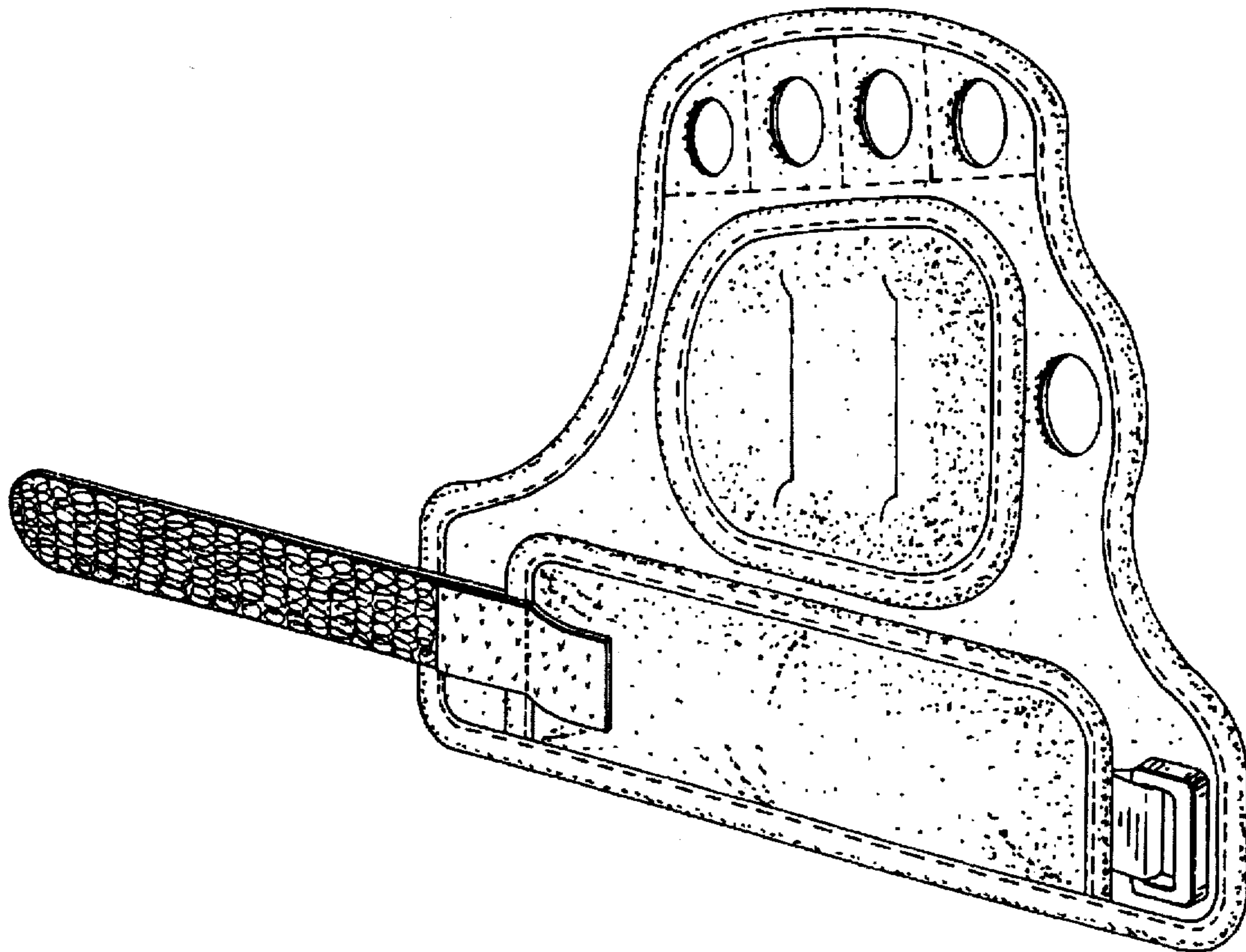

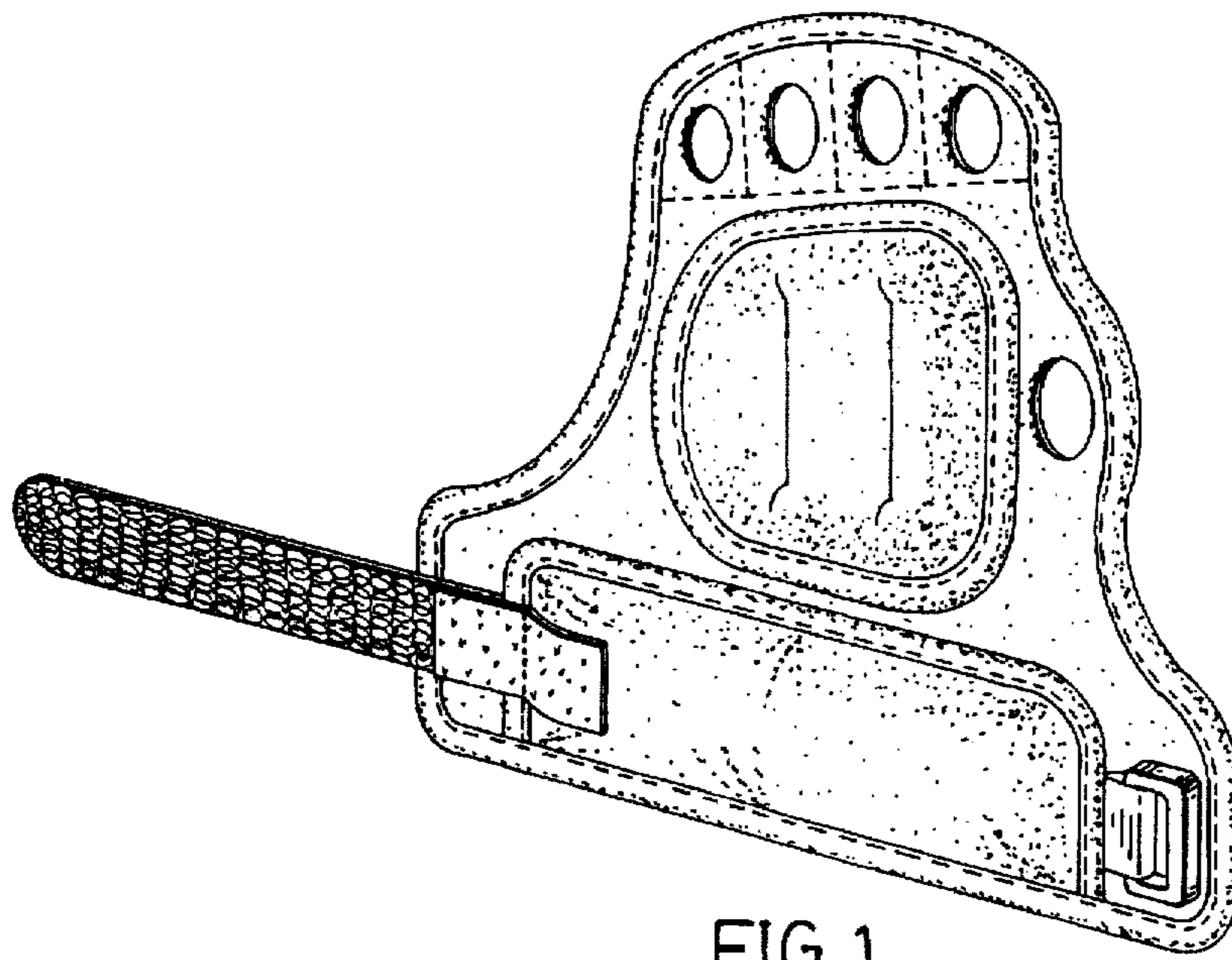

FIG. 1

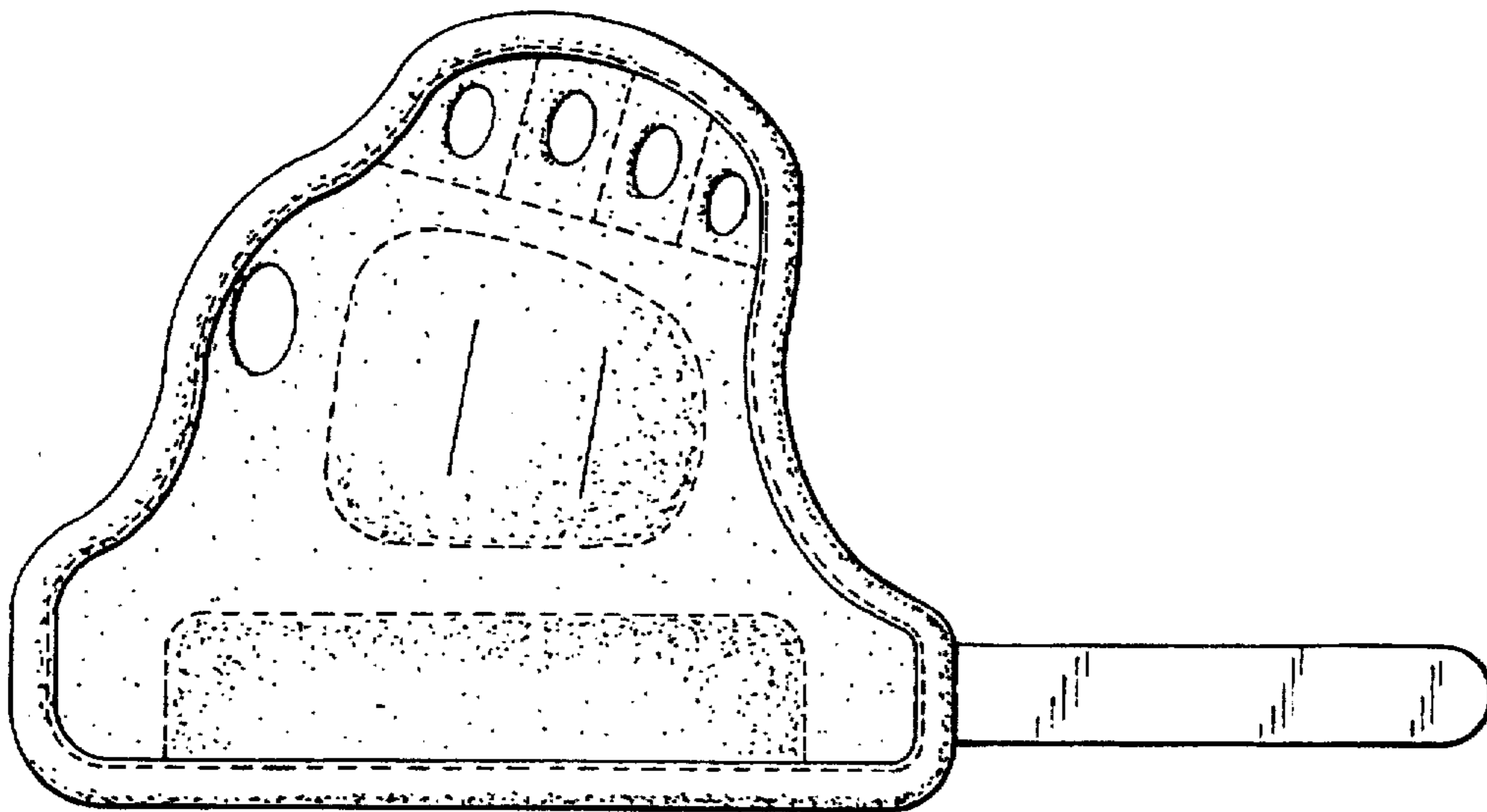

FIG. 3



FIG. 4

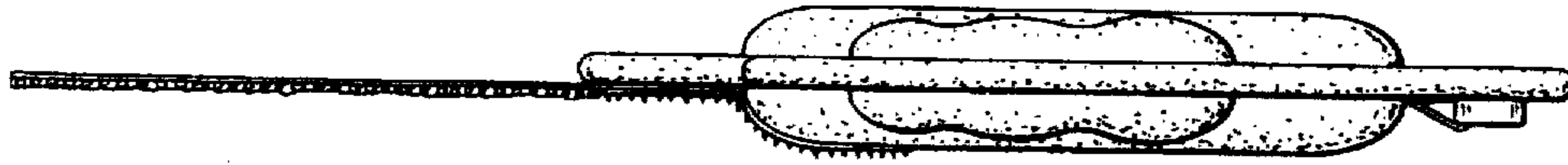

FIG. 6

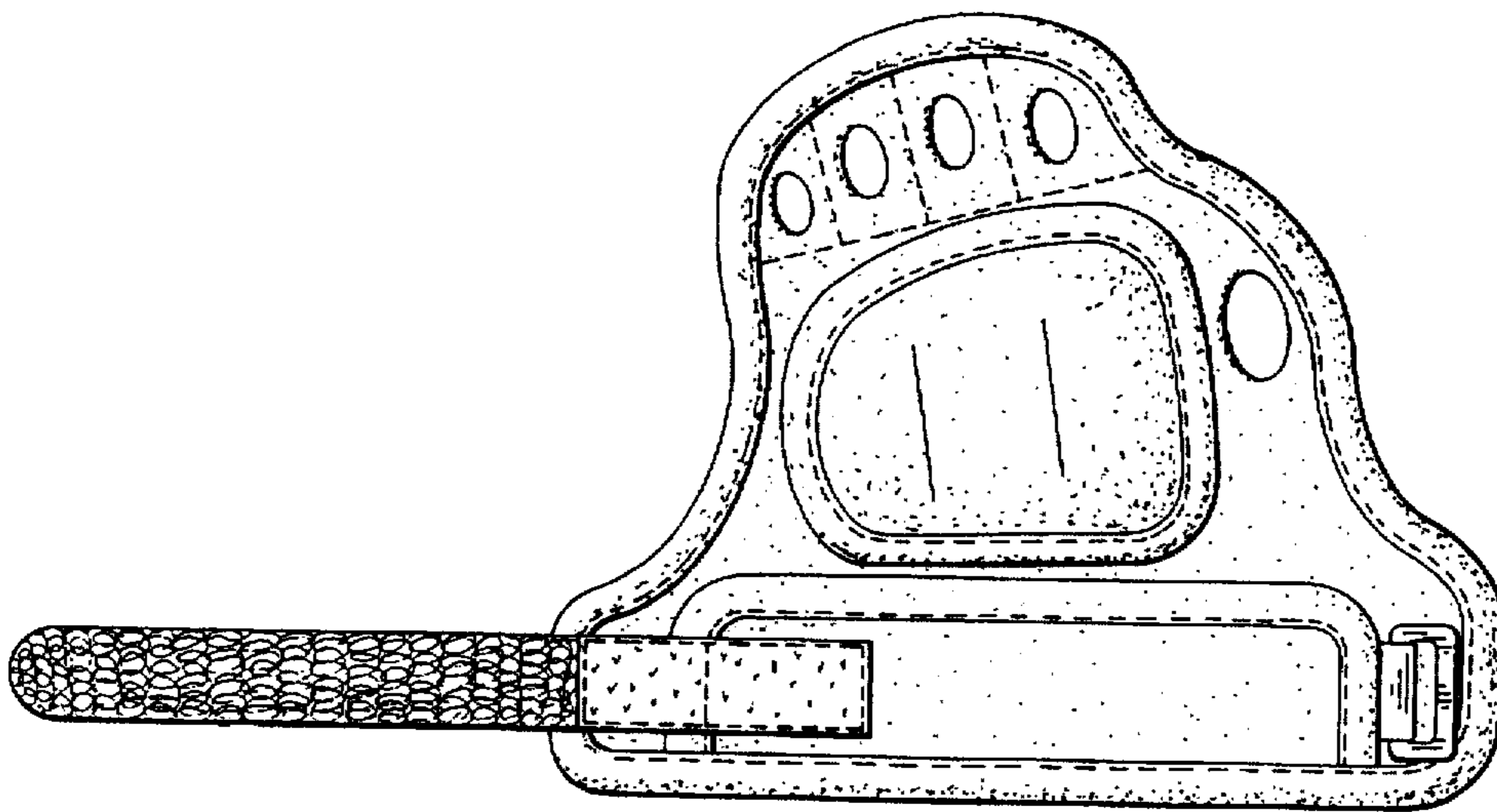

FIG. 2



FIG. 5

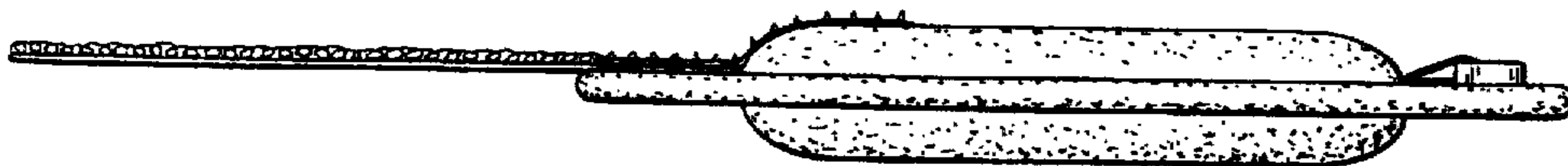

FIG. 7

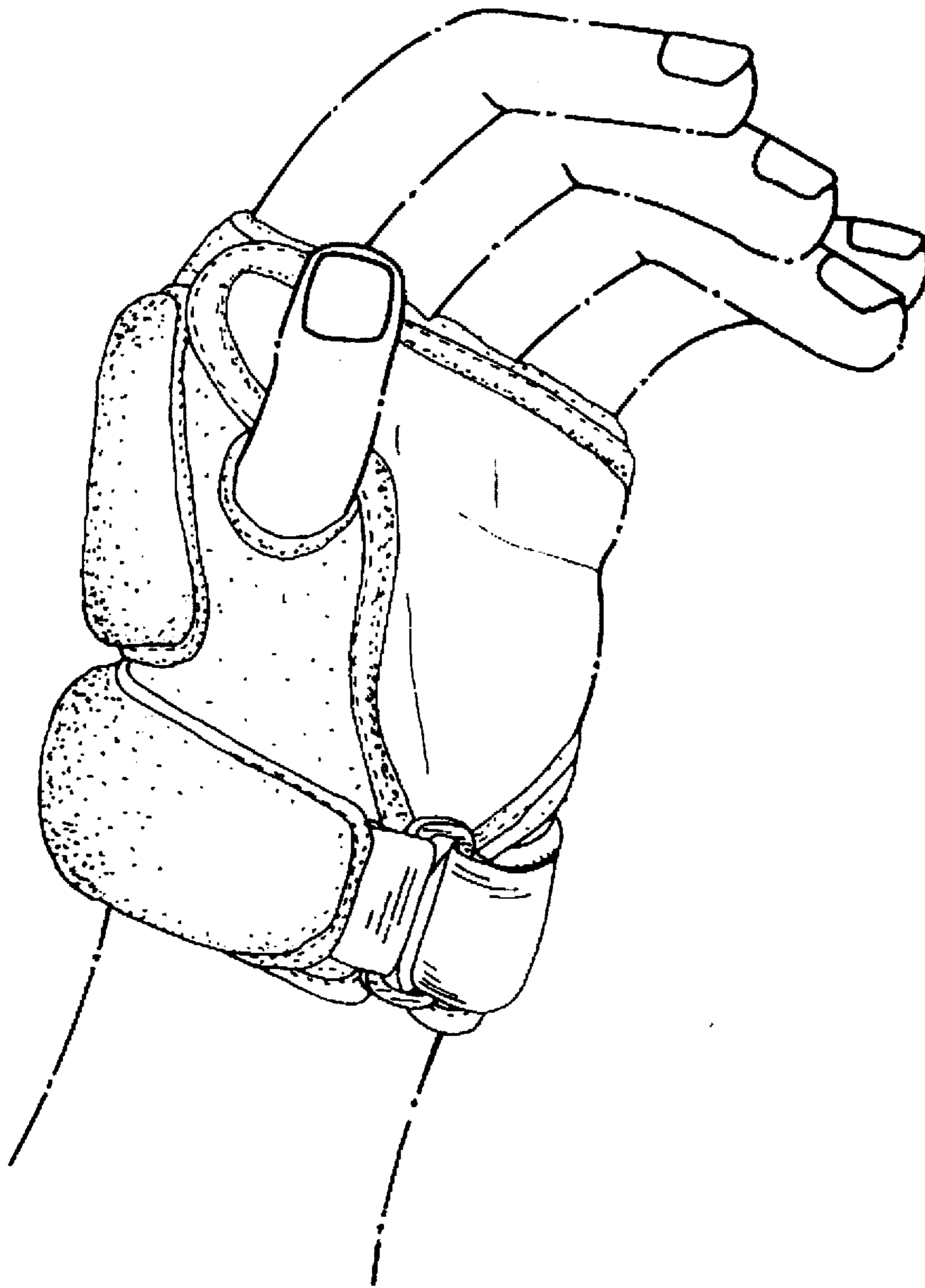

FIG. 8