



US00D387495S

United States Patent [19]

Hester

[11] Patent Number: **Des. 387,495**

[45] Date of Patent: ****Dec. 9, 1997**

[54] **DENTAL FLOSS DISPENSER**

[76] Inventor: **Lisa A. Hester**, 140 Dunecrest Ave.,
Monterey, Calif. 93940

[**] Term: **14 Years**

[21] Appl. No.: **62,818**

[22] Filed: **Nov. 26, 1996**

[51] **LOC (6) Cl.** **28-03**

[52] **U.S. Cl.** **D28/64; D17/7**

[58] **Field of Search** **D28/64; 132/321-327;**
D1/102, 104, 106, 113, 127; D24/100, 101,
103; D17/7

[56] **References Cited**

U.S. PATENT DOCUMENTS

D. 255,370	6/1980	Hayama et al.	D17/7
D. 310,273	8/1990	Woodman	D28/64
D. 368,986	4/1996	Haber et al.	D28/64
D. 377,998	2/1997	Dunn	D28/64

OTHER PUBLICATIONS

The Music Stand, Aug. 1989, p. 20, #5723 Piano Soap Dish.

Primary Examiner—Kay H. Chin

Attorney, Agent, or Firm—Holland & Hart LLP

[57] **CLAIM**

The ornamental design for a dental floss dispenser, as shown and described.

DESCRIPTION

FIG. 1 is a front perspective view of a dental floss dispenser showing my new design in full lines with the broken lines showing environmental association matter being for illustrative purposes only and forming no part of the claimed design;

FIG. 2 is a top plan view thereof;

FIG. 3 is a left side elevational view thereof;

FIG. 4 is a front elevational view thereof;

FIG. 5 is a right side elevational view thereof;

FIG. 6 is a bottom plan view thereof; and,

FIG. 7 is a back elevational view thereof.

1 Claim, 1 Drawing Sheet

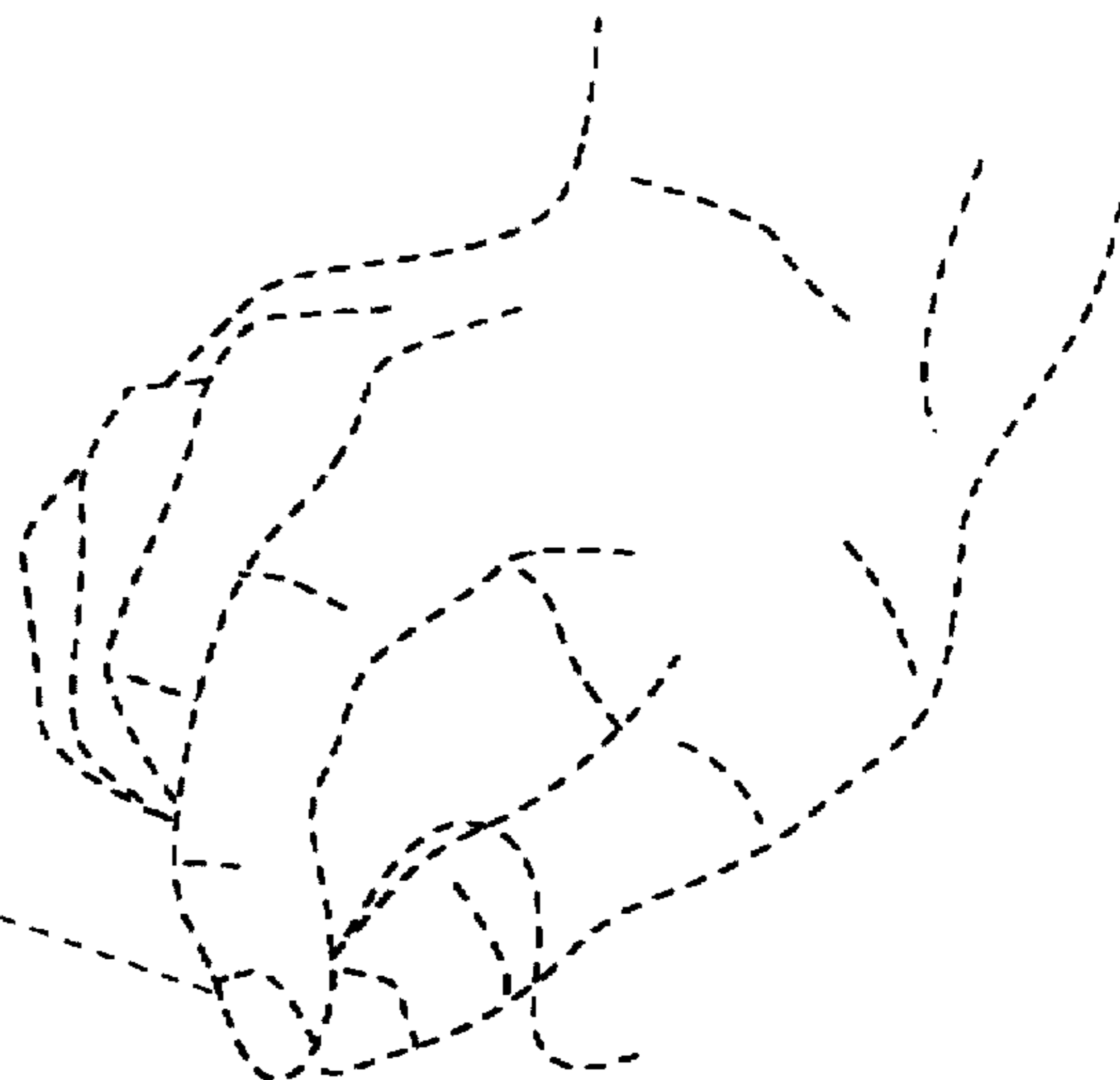
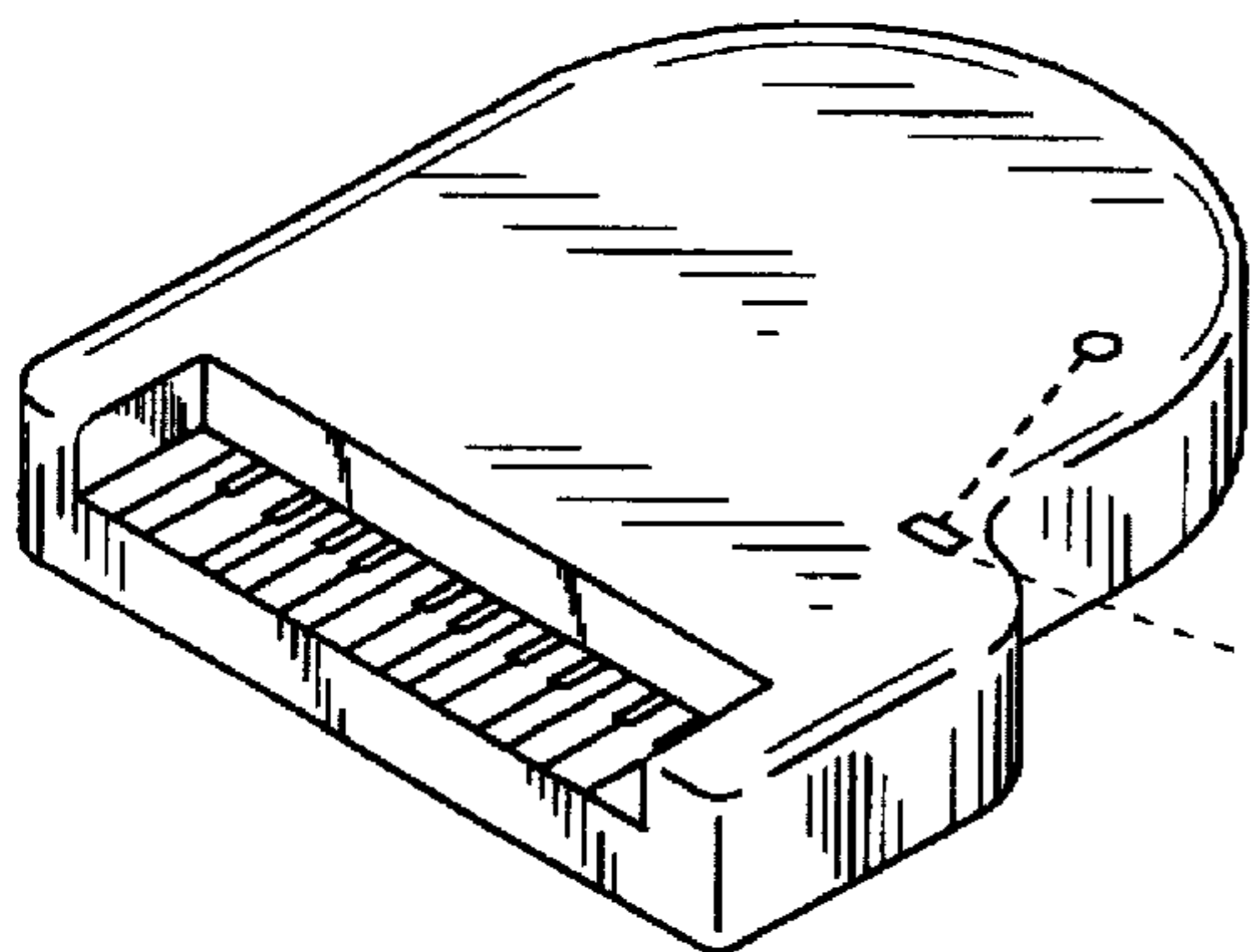

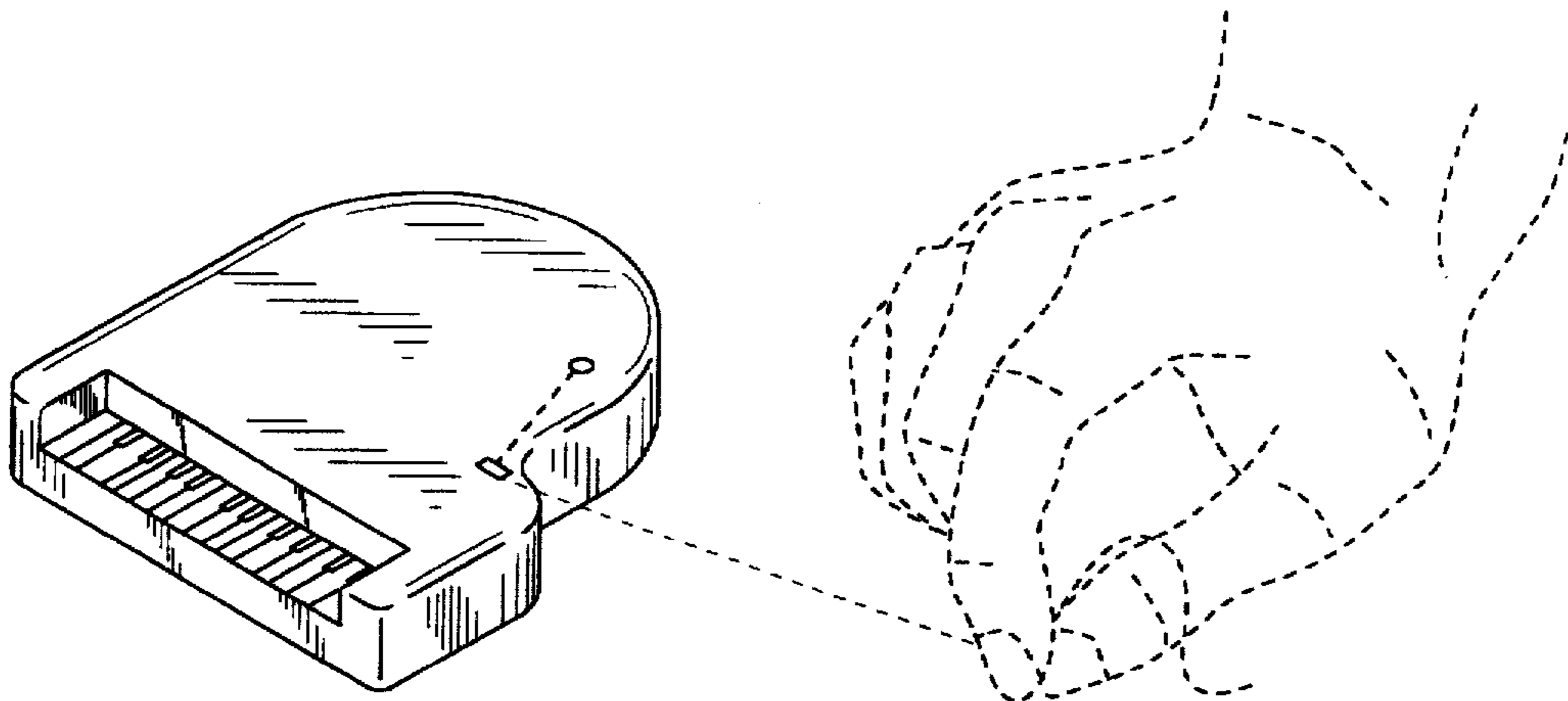

Fig. 1

Fig. 2

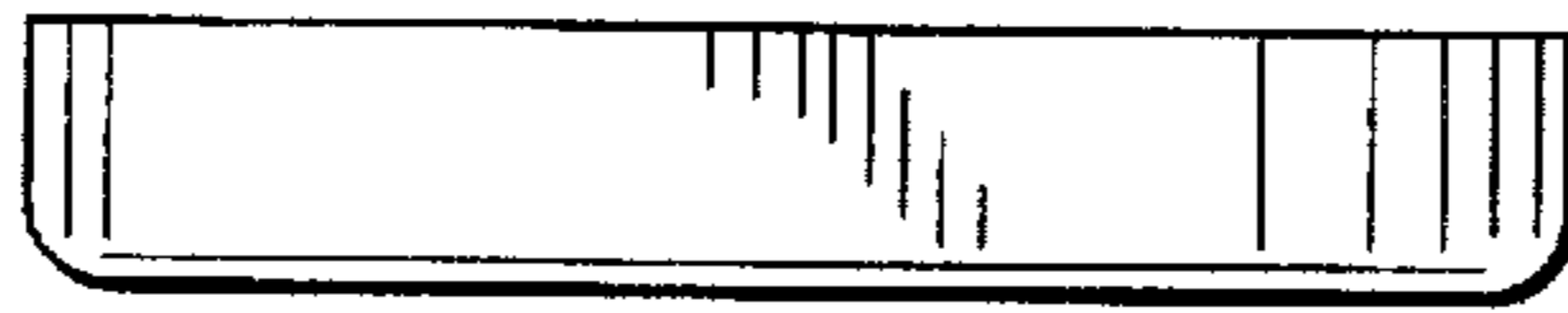

Fig. 3

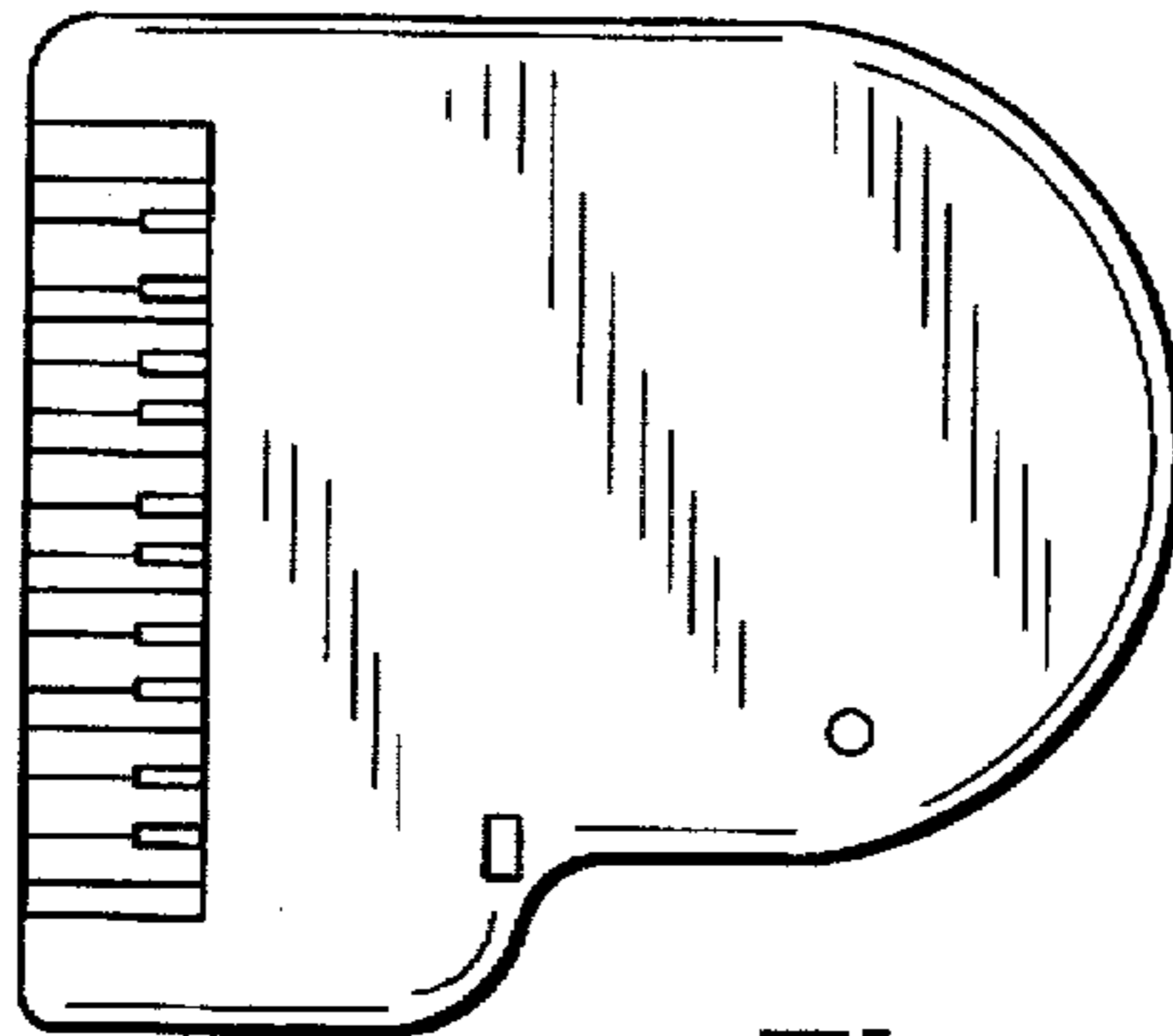

Fig. 4

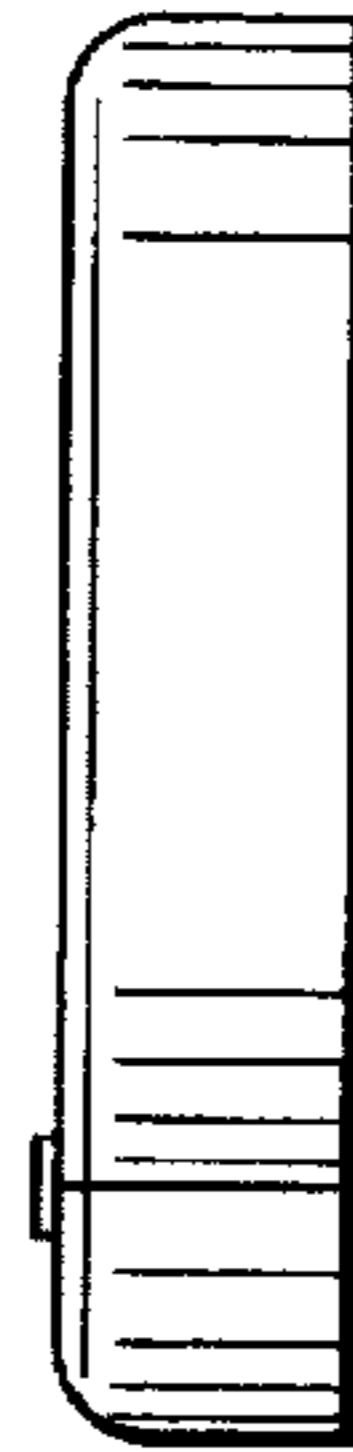

Fig. 5

Fig. 6

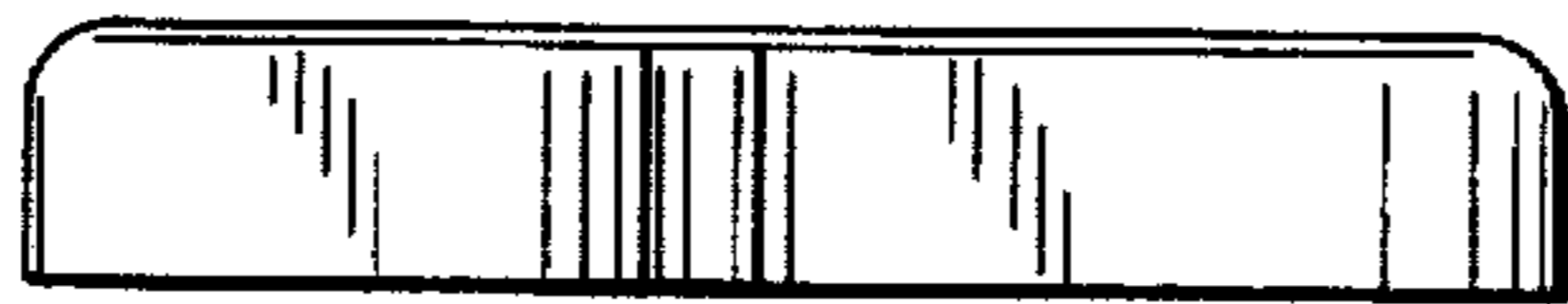

Fig. 7

