



US00D387263S

United States Patent [19]

Bidstrup et al.

[11] Patent Number: **Des. 387,263**

[45] Date of Patent: ****Dec. 9, 1997**

[54] **TOOL HANDLE**

[75] Inventors: **Stinse Blem Bidstrup**, Copenhagen, Denmark; **Steven Zlomke**, Beatrice, Nebr.; **Peter Hesselberg**, Holback, Denmark

[73] Assignee: **American Tool Companies, Inc.**, Kenosha, Wis.

[**] Term: **14 Years**

[21] Appl. No.: **53,352**

[22] Filed: **Feb. 27, 1996**

[51] **LOC (6) Cl.** **08-03**

[52] **U.S. Cl.** **D8/97; D8/107**

[58] **Field of Search** **D8/1, 7, 8, 9, D8/95, 96, 97, 107; 30/260, 339, 517, 505, 515, 506, 507; 43/23**

[56] **References Cited**

U.S. PATENT DOCUMENTS

D. 42,960	9/1912	Disston .	
D. 70,665	7/1926	Forsberg	D8/97
D. 103,969	4/1937	Jack	D8/96
D. 118,415	1/1940	Nessen .	
D. 137,060	1/1944	Lodeen .	
D. 152,760	2/1949	Weaver .	
D. 153,407	4/1949	Weaver	D8/97
156,369	10/1874	Millspaugh .	
183,805	10/1876	Holden .	
D. 184,860	4/1959	Dreier	D8/97
D. 231,076	4/1974	Carlsson .	
D. 251,963	5/1979	Breger	D8/97

D. 269,848	7/1983	Covey .	
D. 317,395	6/1991	Landahl .	
D. 323,966	2/1992	Tanabe .	
1,817,980	8/1931	Forsberg et al.	30/513
2,017,895	10/1935	Davey	30/517
2,437,296	3/1948	Forsberg	D8/97 X

Primary Examiner—Martie Thompson
Attorney, Agent, or Firm—Brinks Hofer Gilson & Lione

[57] **CLAIM**

The ornamental design for a tool handle, as shown and described.

DESCRIPTION

FIG. 1 is a left side view showing one embodiment of our new design for a tool handle;
 FIG. 2 is a front view thereof;
 FIG. 3 is a rear view thereof;
 FIG. 4 is a top view thereof;
 FIG. 5 is a bottom view thereof;
 FIG. 6 is a right side view thereof;
 FIG. 7 is a left side perspective view thereof;
 FIG. 8 is a left side view showing a second embodiment of our new design for a tool handle;
 FIG. 9 is a front view thereof;
 FIG. 10 is a rear view thereof;
 FIG. 11 is a top view thereof;
 FIG. 12 is a bottom view thereof;
 FIG. 13 is a right side view thereof; and,
 FIG. 14 is a left side perspective view thereof.

The broken lines in FIGS. 1-14 are for environmental purposes only and form no part of the claimed designs.

1 Claim, 8 Drawing Sheets

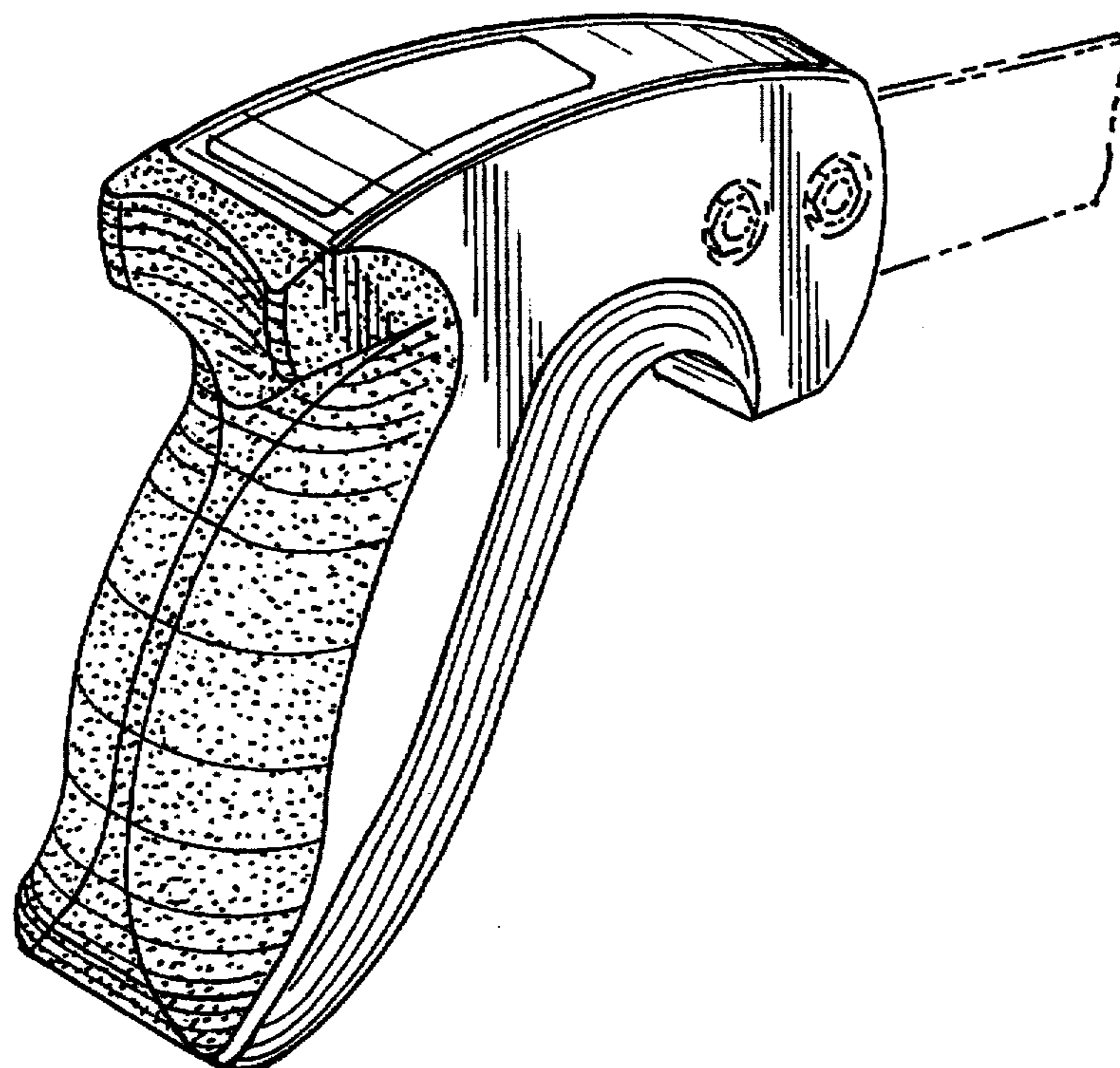

FIG. 2

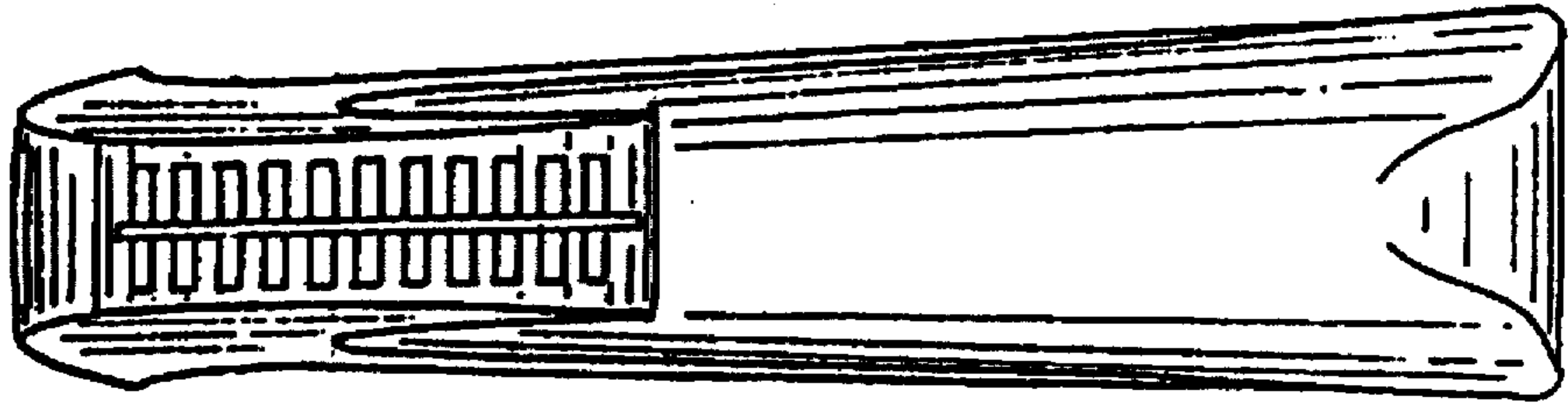

FIG. 1

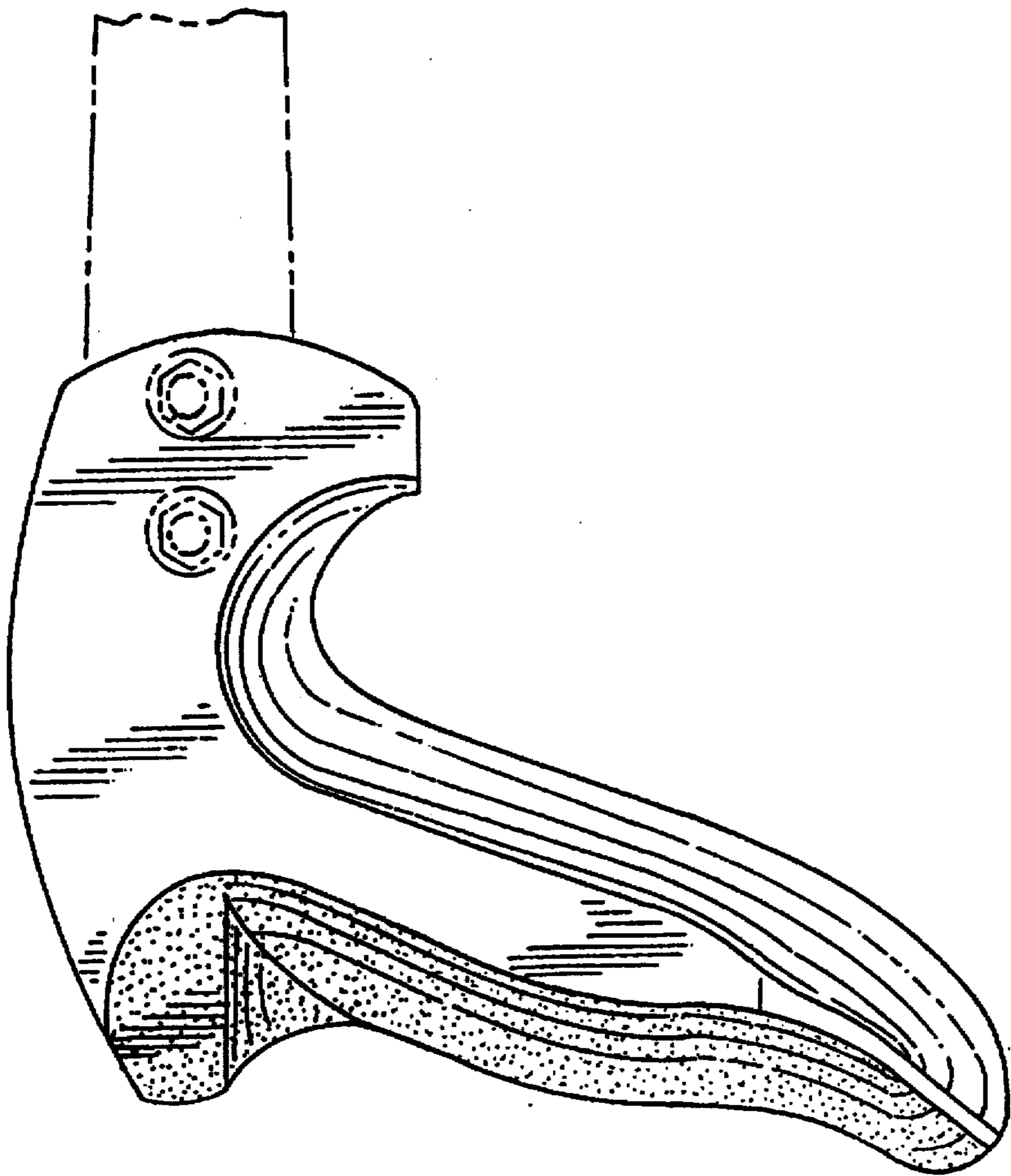

FIG. 3

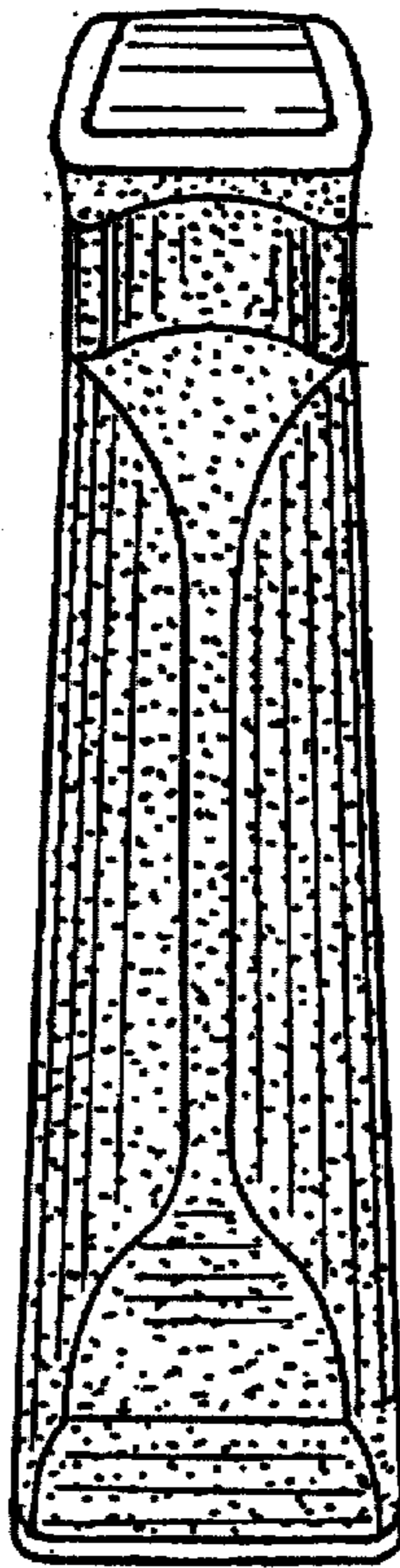

FIG. 4

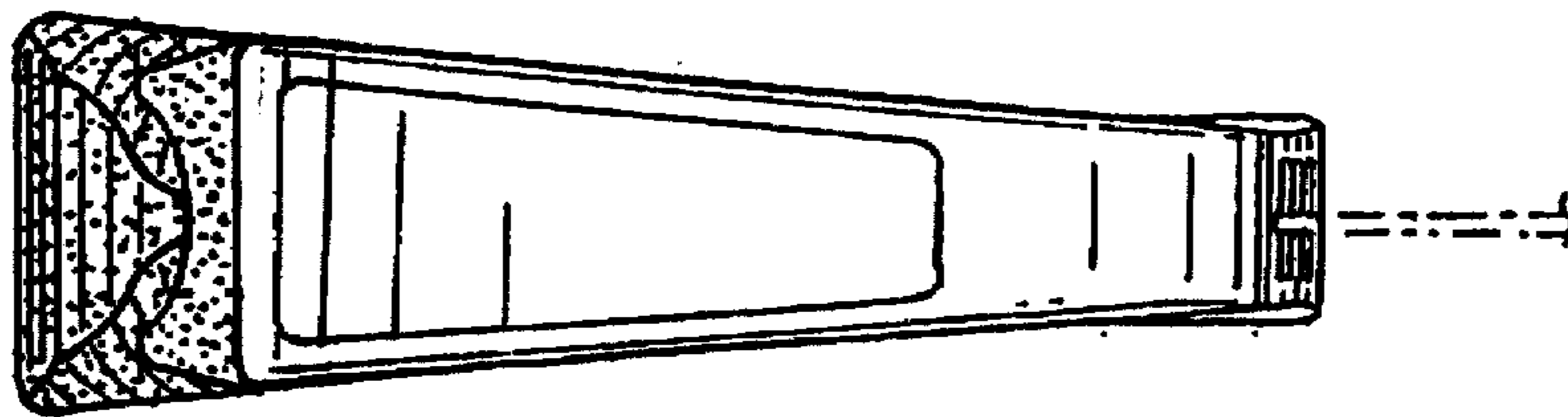
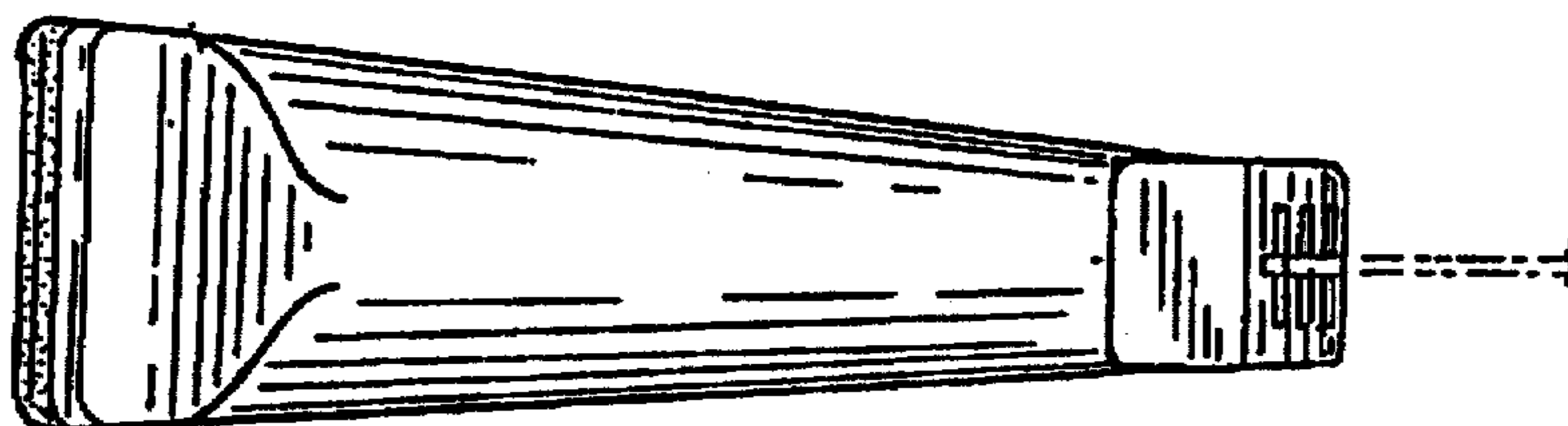

FIG. 5



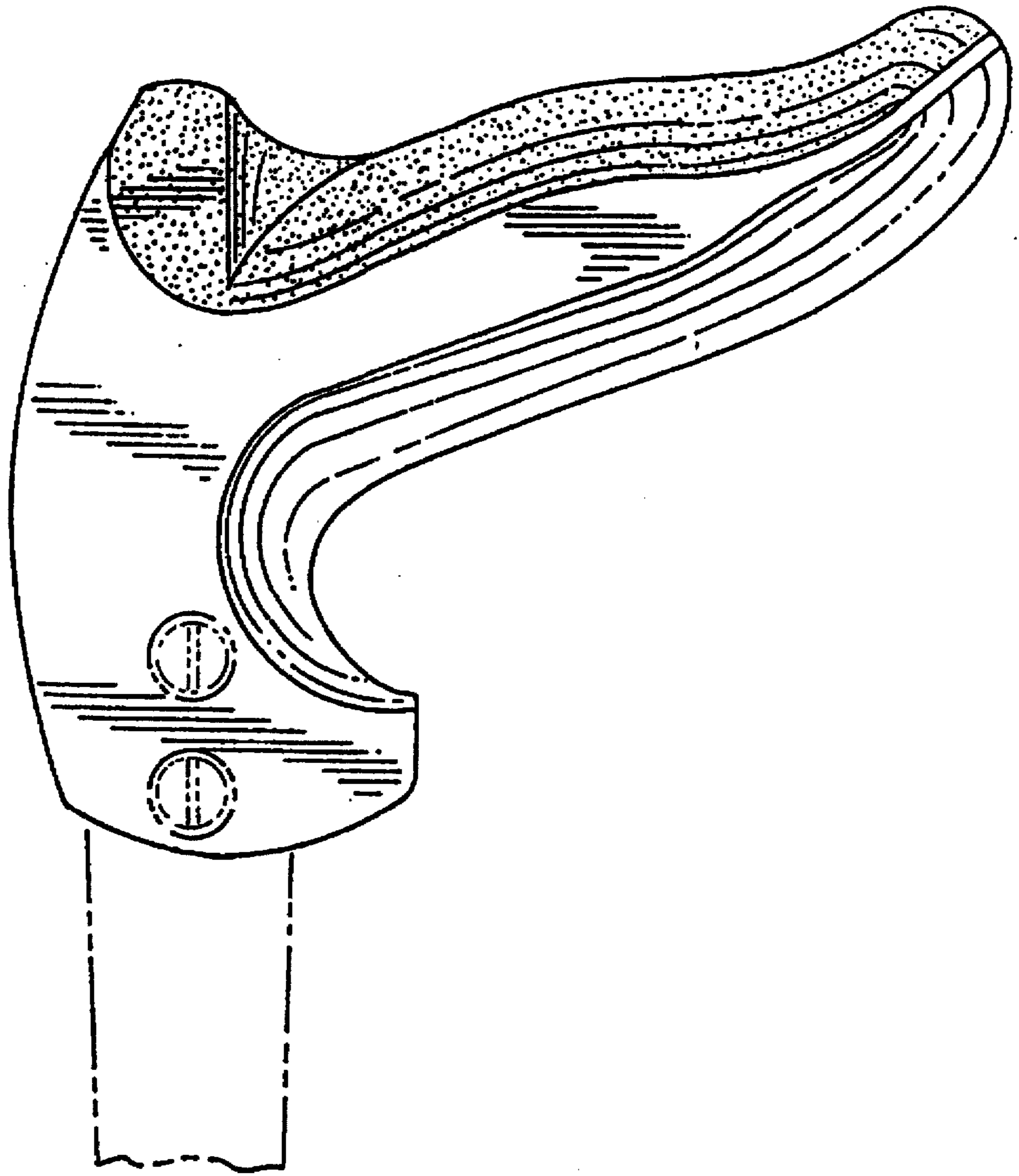

FIG. 6

FIG. 7

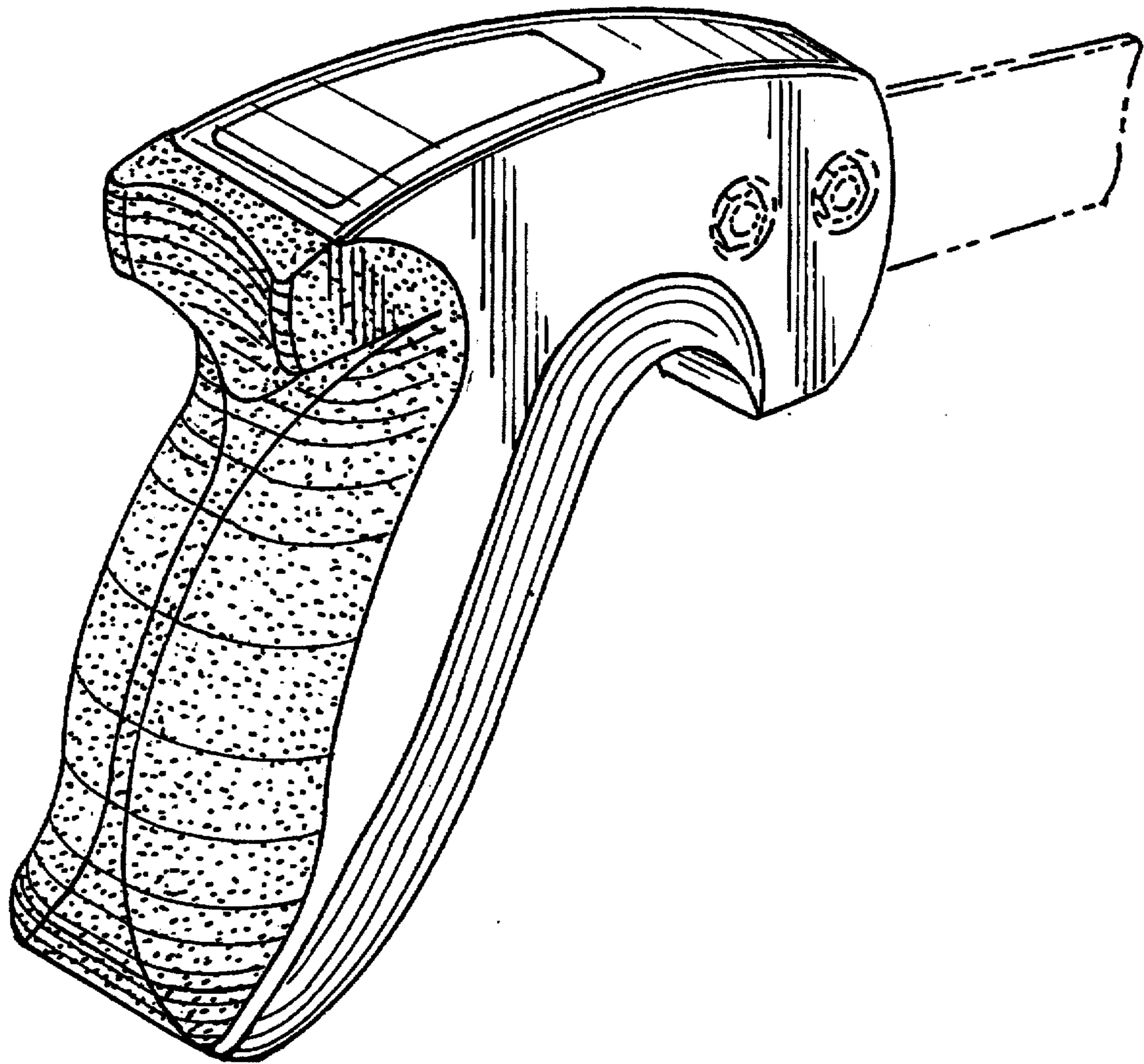

FIG. 9

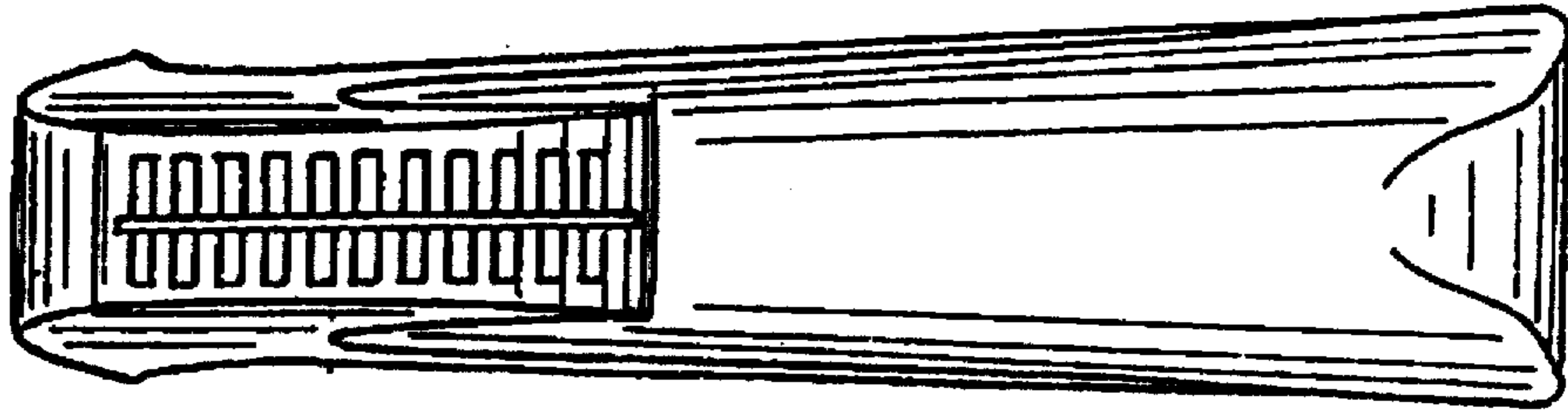

FIG. 8

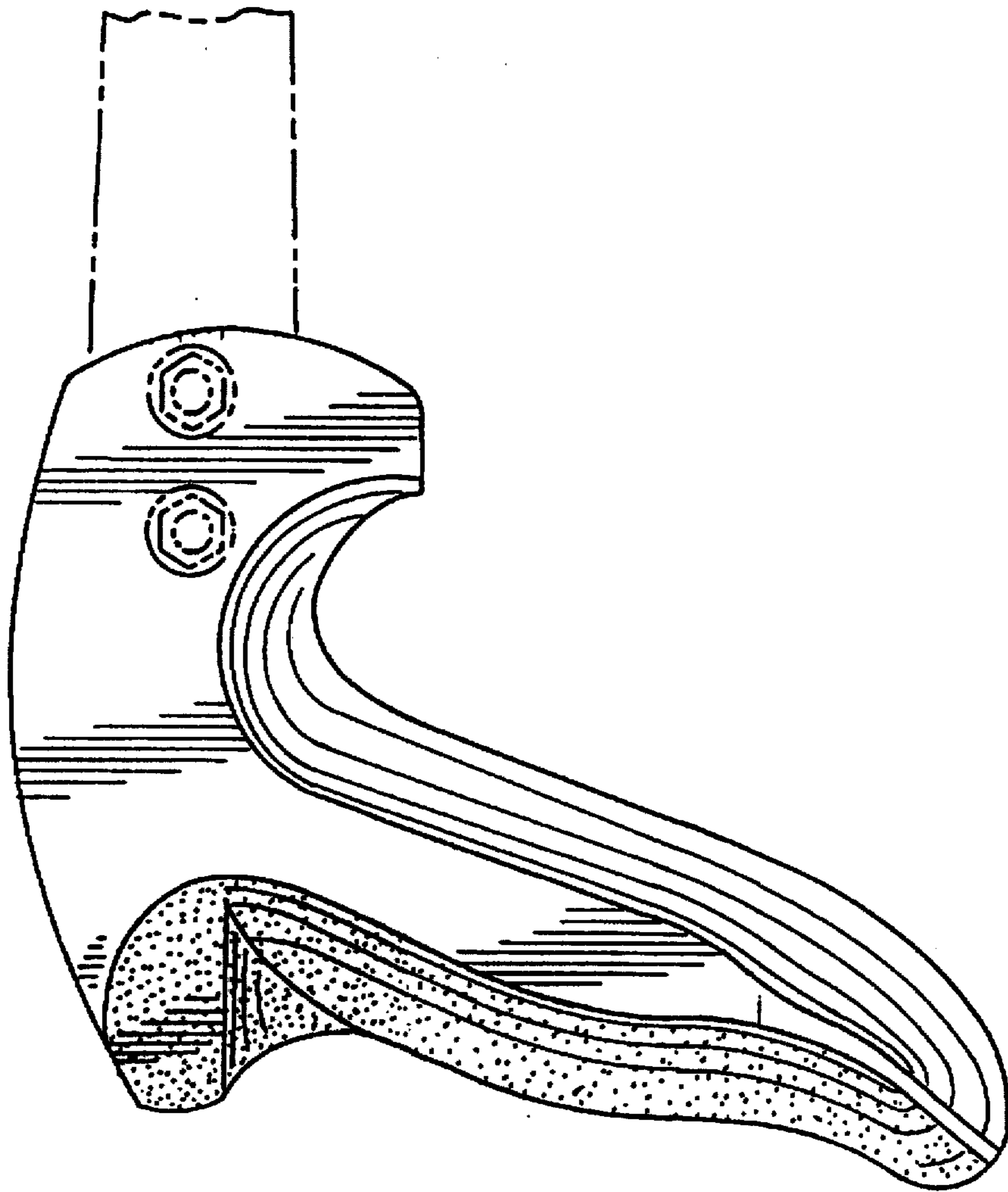

FIG. 10

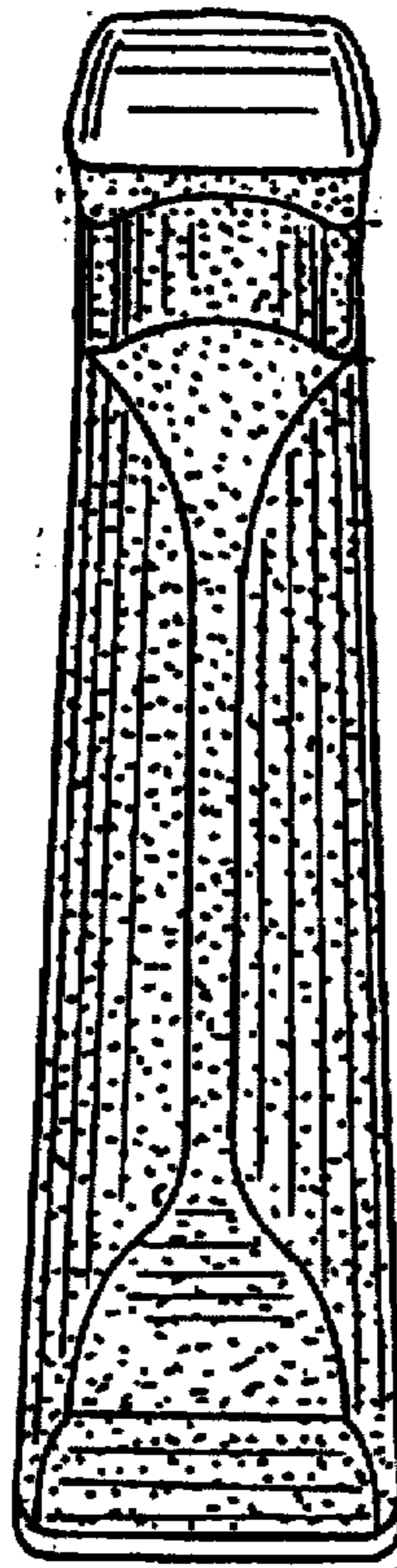

FIG. 11

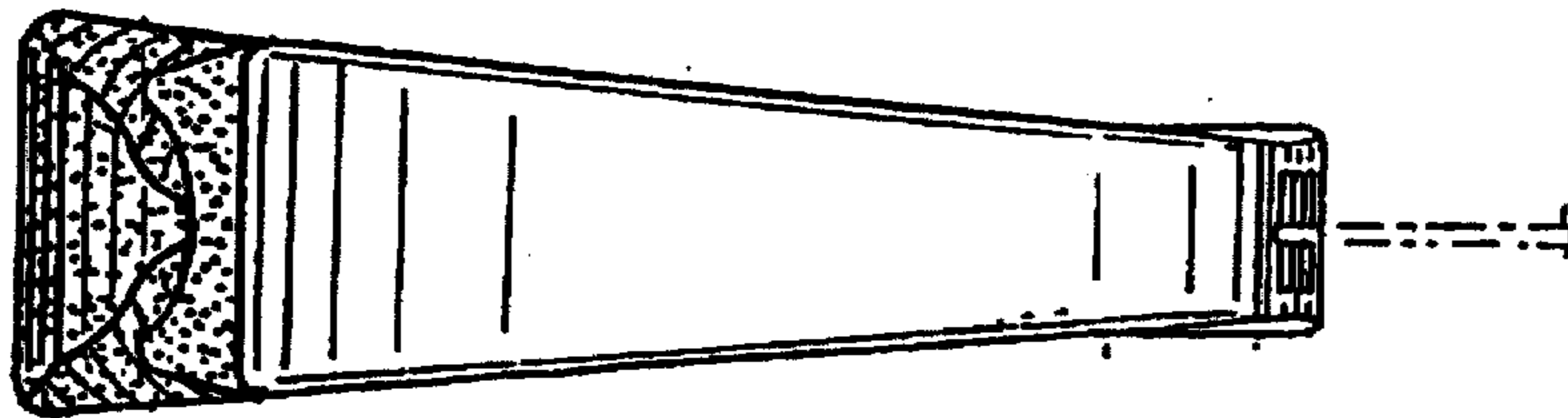
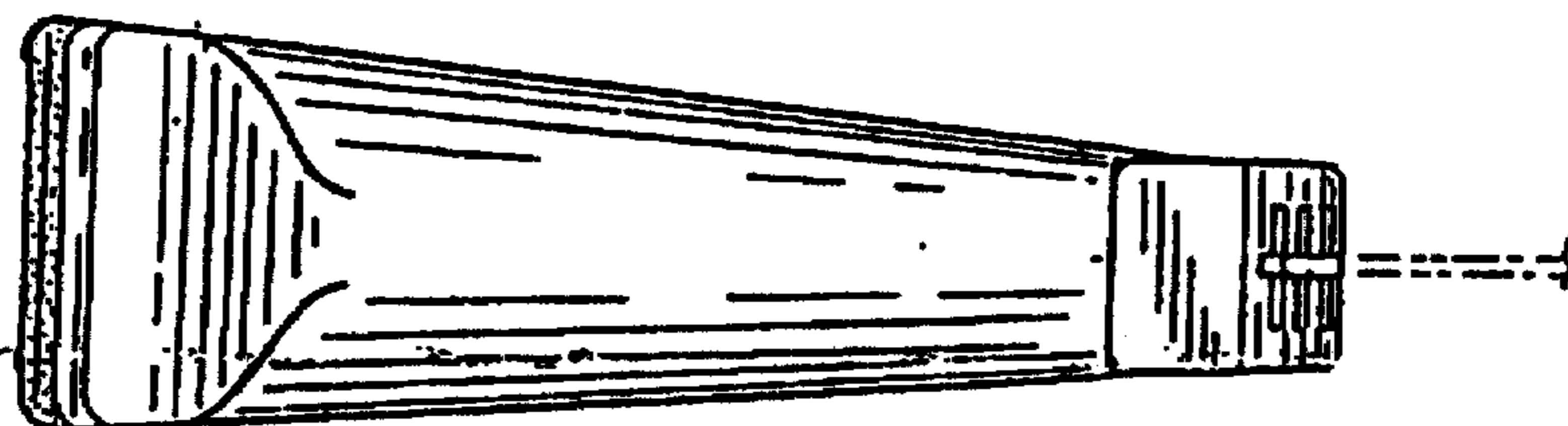

FIG. 12



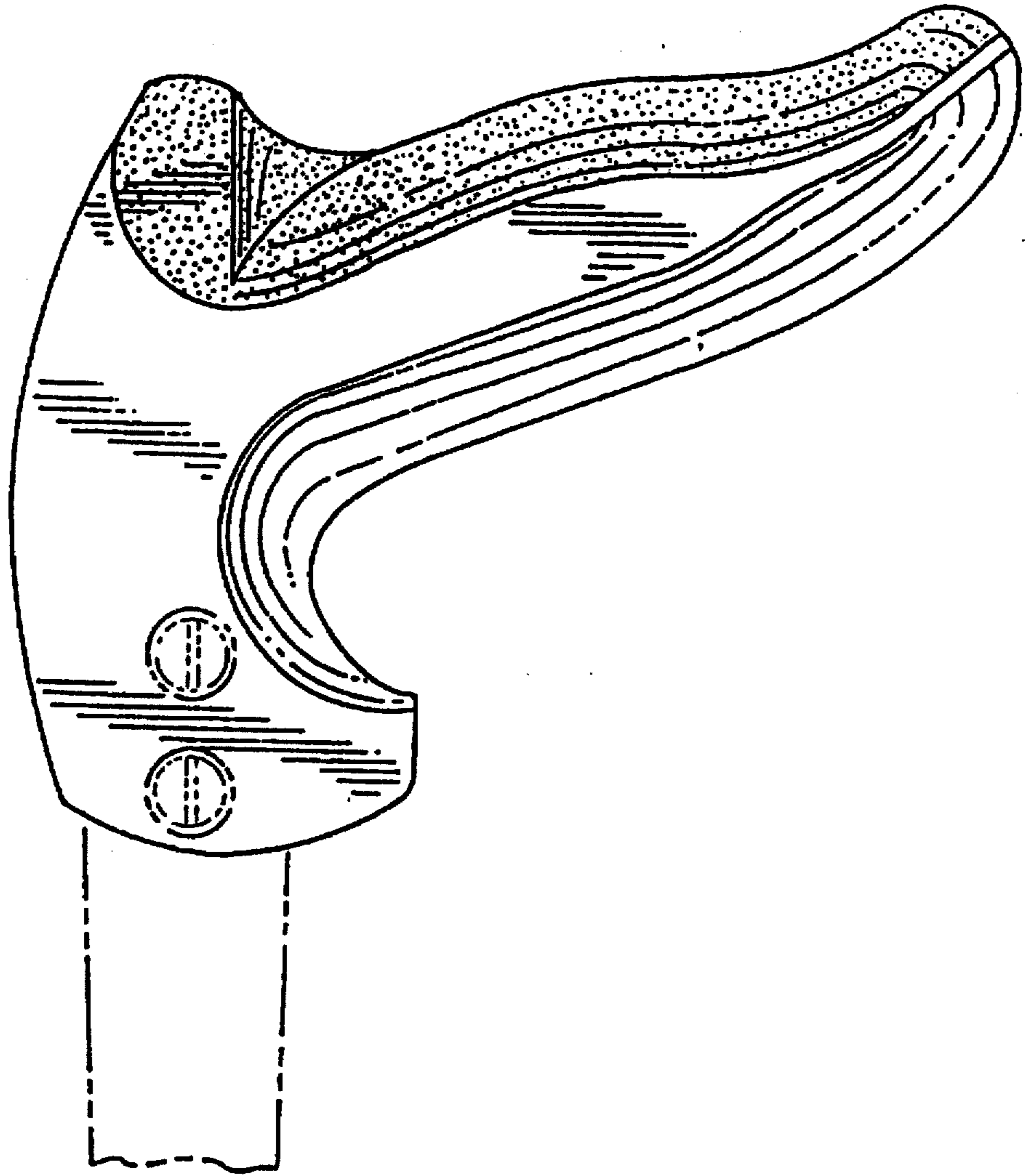

FIG. 13

FIG. 14

