



US00D387245S

**United States Patent** [19]  
**Hippen et al.**

[11] **Patent Number: Des. 387,245**  
[45] **Date of Patent: \*\*Dec. 9, 1997**

[54] **STAND MIXER HOUSING**

[75] Inventors: **Jan Hippen**, Portland, Oreg.; **Julius Lucaci**, Wheeling, Ill.

[73] Assignee: **Black & Decker Inc.**, Newark, Del.

[\*\*] Term: **14 Years**

[21] Appl. No.: **62,857**

[22] Filed: **Nov. 29, 1996**

[51] LOC (6) Cl. .... **31-00**

[52] U.S. Cl. .... **D7/379; D7/309; D7/310; D7/376**

[58] Field of Search ..... **D7/376, 377, 378, D7/386, 379, 309-311; 366/129, 130, 197, 199, 204, 205, 314**

[56] **References Cited**

**U.S. PATENT DOCUMENTS**

D. 189,936	3/1961	Grange .....	D7/379
D. 209,072	10/1967	Duncan .....	D7/379
D. 239,758	5/1976	Claxton et al. ....	D7/309
D. 265,042	6/1982	Hanson et al. ....	D7/309
D. 279,858	7/1985	Janssens .....	D7/379
D. 284,633	7/1986	Viancin .....	D7/379
D. 286,258	10/1986	Grange .....	D7/379
D. 314,883	2/1991	Naft .....	D7/379
D. 315,473	3/1991	Copeland .....	D7/379
D. 354,878	1/1995	Lin .....	D7/310 X

**OTHER PUBLICATIONS**

Undated Catalog, p. 53, Rival Mixers, upper half of page.

*Primary Examiner*—Caron D. Veynar  
*Attorney, Agent, or Firm*—Barry E. Deutsch

[57] **CLAIM**

The ornamental design for stand mixer housing, as shown and described.

**DESCRIPTION**

FIG. 1 is a perspective view of our new design of a stand mixer housing;

FIG. 2 is a front elevational view of our new design of the stand mixer housing;

FIG. 3 is a rear elevational view of our new design of the stand mixer housing;

FIG. 4 is a right side elevational view of our new design of the stand mixer housing;

FIG. 5 is a left side elevational view of our new design of the stand mixer housing;

FIG. 6 is a top plan view of our new design of the stand mixer housing; and,

FIG. 7 is a bottom plan view of our new design of the stand mixer housing.

FIGS. 2—7 are drawn on a reduced scale from FIG. 1.

**1 Claim, 4 Drawing Sheets**

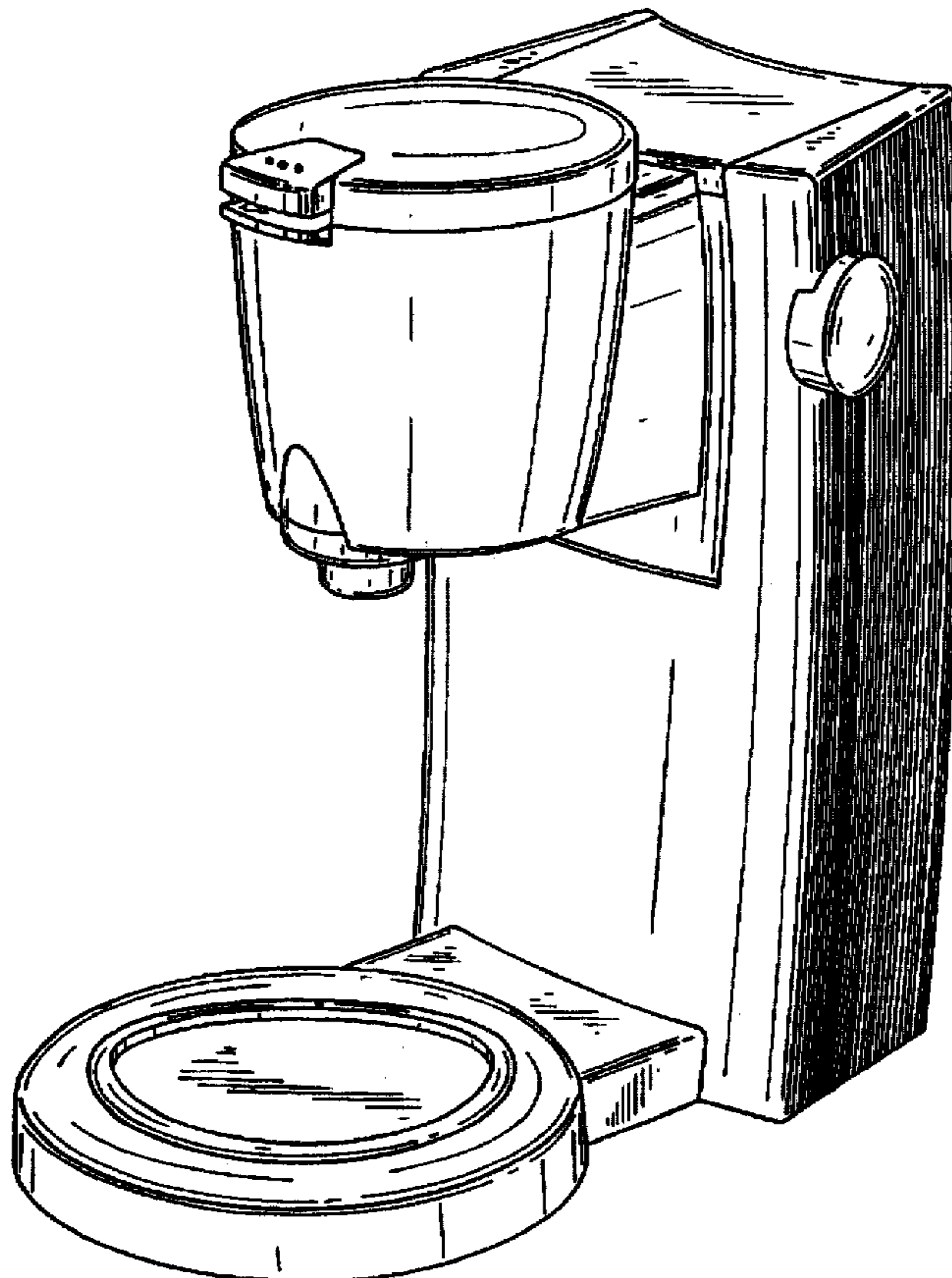

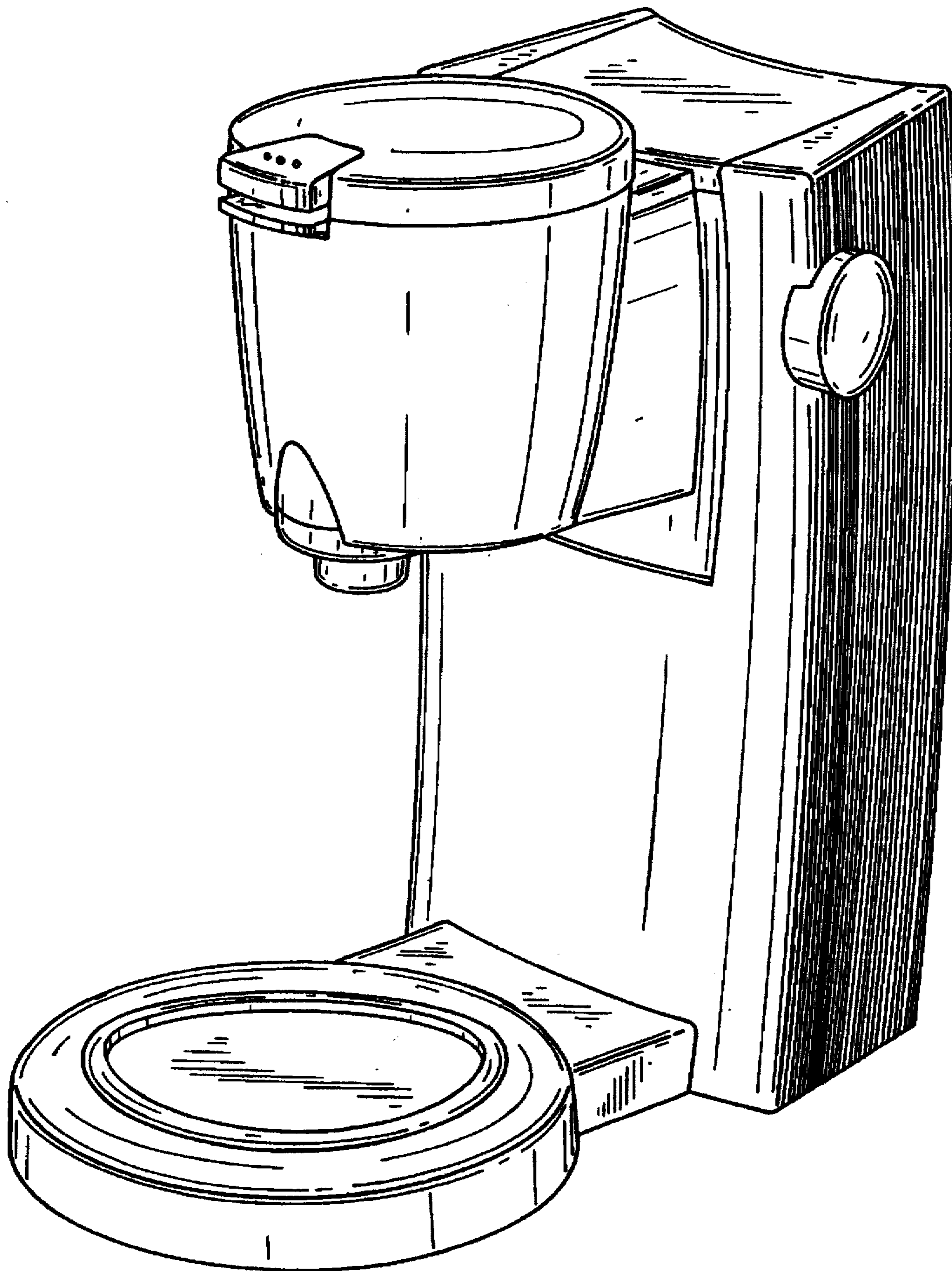

FIG. 1

FIG. 3

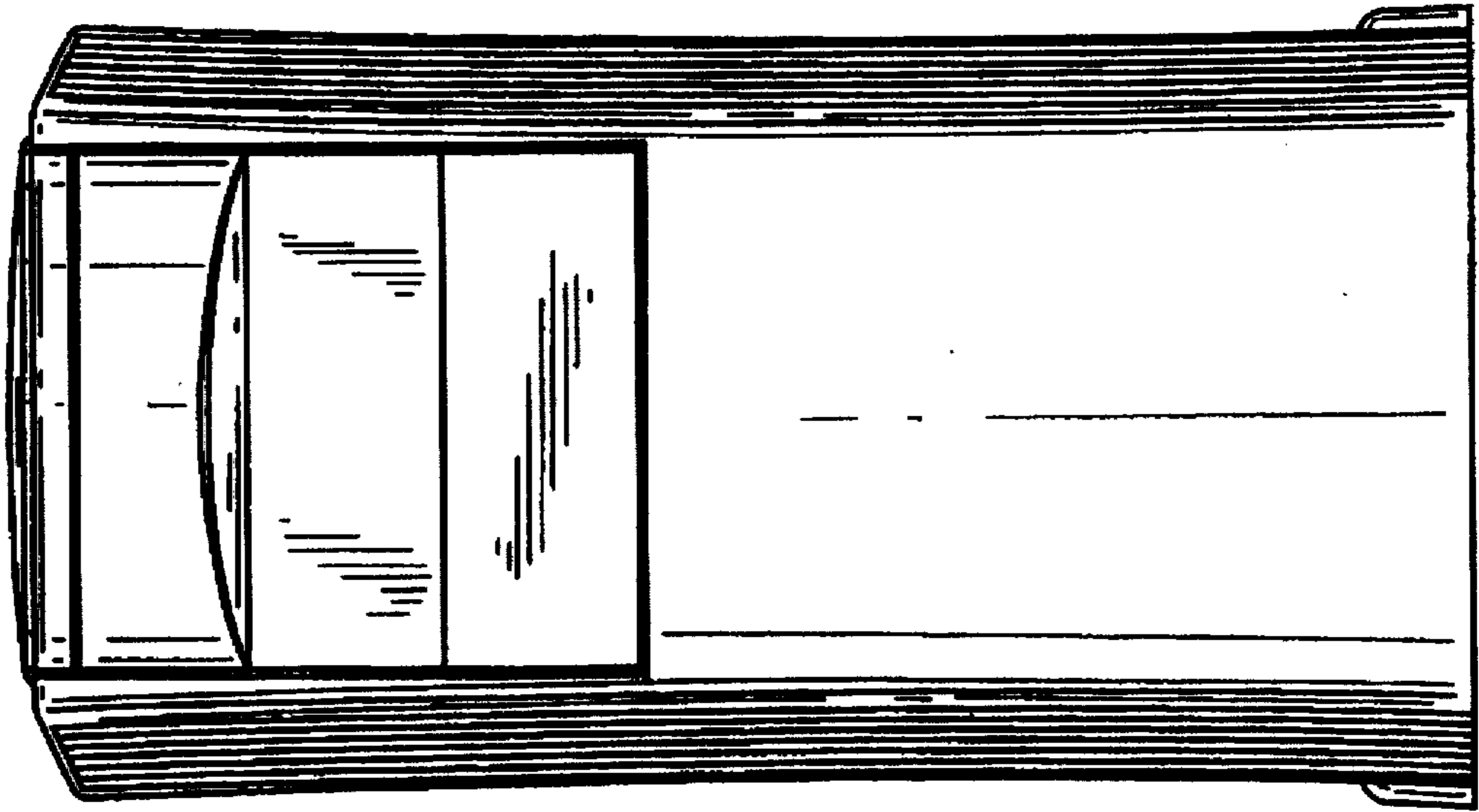
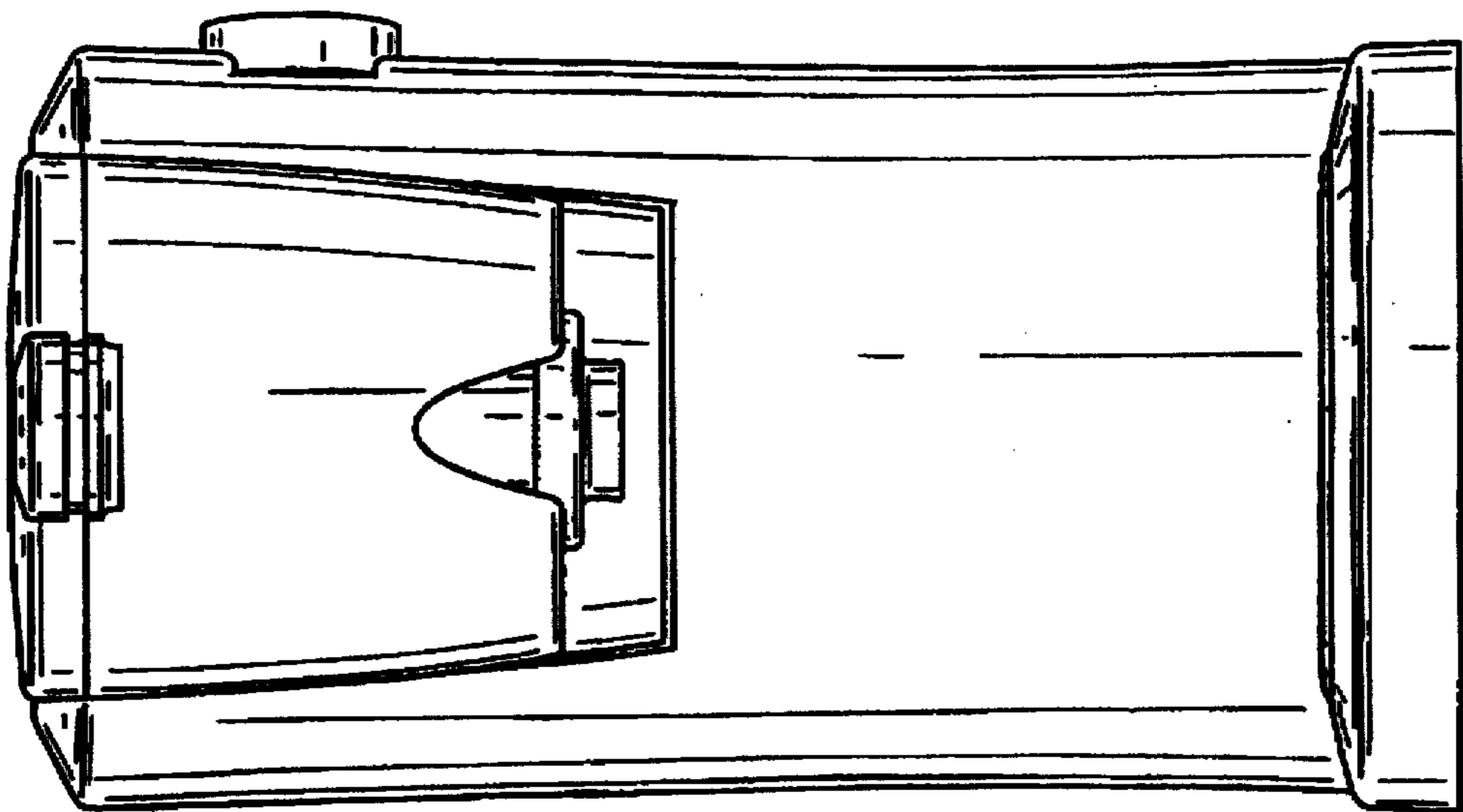

FIG. 2





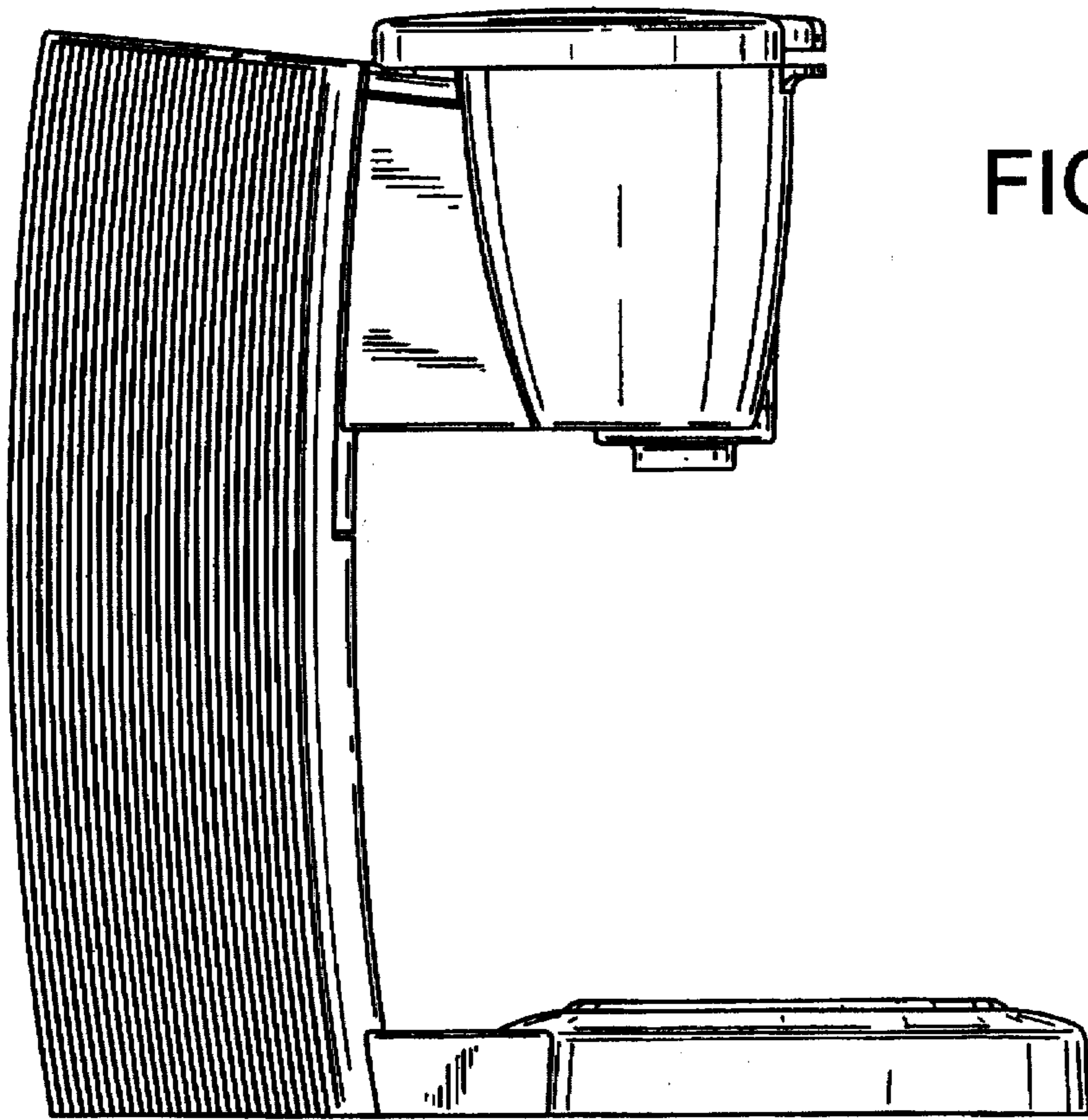

FIG. 4

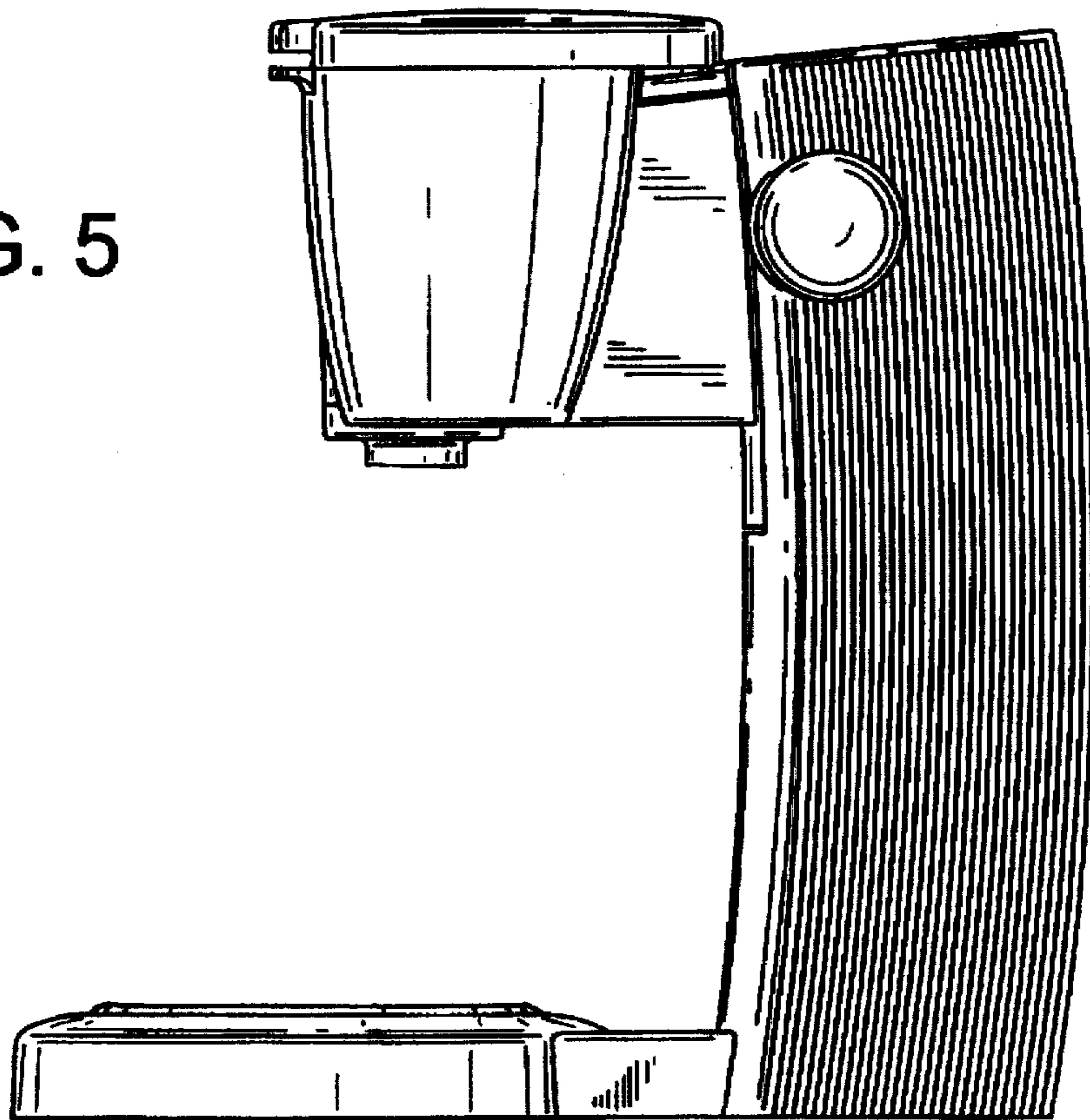

FIG. 5

FIG. 7

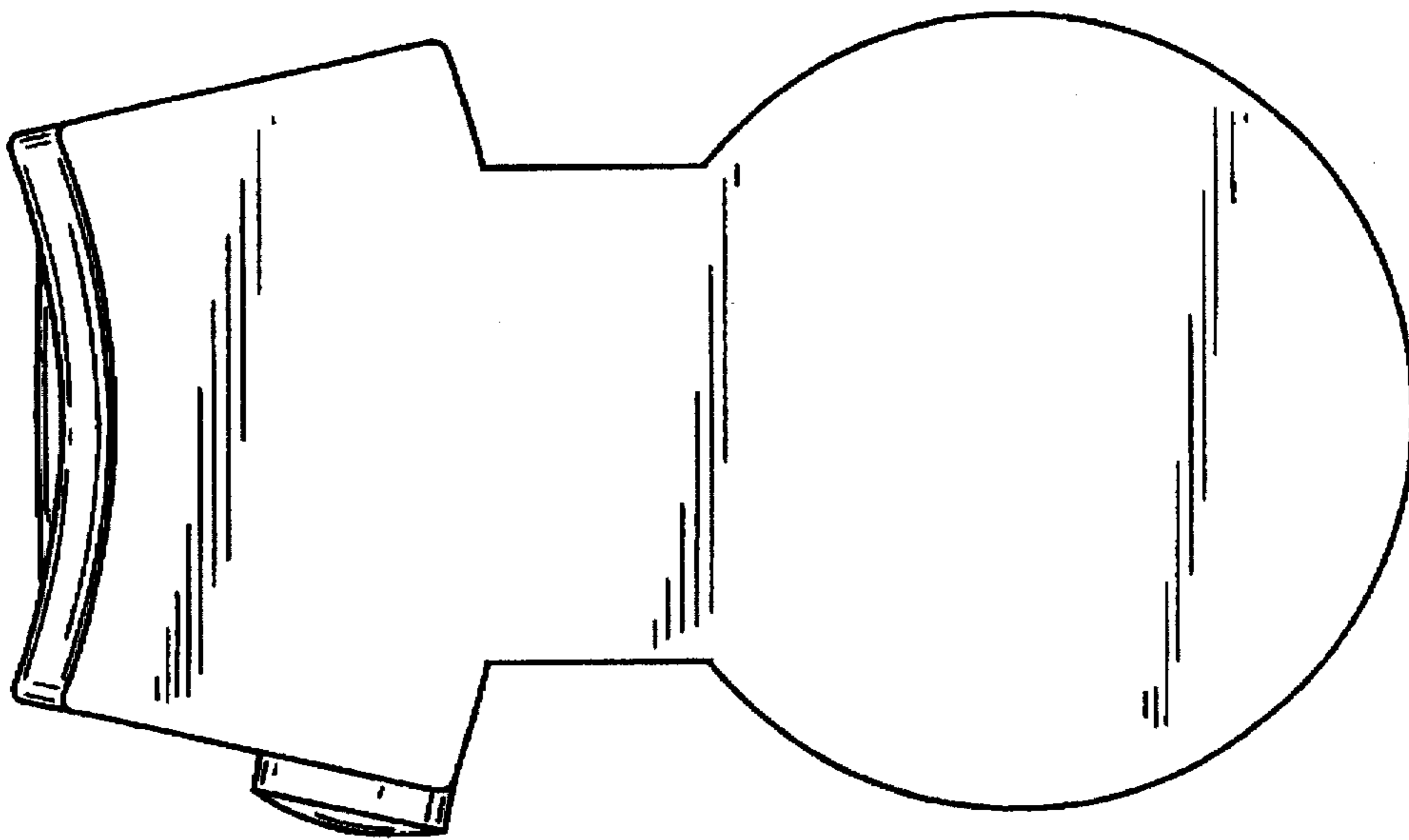

FIG. 6

