



US00D387215S

# United States Patent [19]

Proano et al.

[11] Patent Number: **Des. 387,215**

[45] Date of Patent: **\*\*Dec. 9, 1997**

[54] **CONVERTIBLE CRIB IN ADULT BED CONFIGURATION**

[76] Inventors: **Lou Proano; Rene D. Proano**, both of 1648 Channelside Trail, Baldwinsville, N.Y. 13027

[\*\*] Term: **14 Years**

[21] Appl. No.: **56,562**

[22] Filed: **Jul. 2, 1996**

[51] LOC (6) Cl. .... **06-01**

[52] U.S. Cl. .... **D6/395; D6/393**

[58] Field of Search ..... **D6/382-385, 390-395, D6/508; 5/93.1, 93.2, 101, 105**

[56] **References Cited**

**U.S. PATENT DOCUMENTS**

D. 356,452	3/1995	Proano et al. .	
D. 370,364	6/1996	Proano et al. ....	D6/395
2,223,955	12/1940	Greenbaum .....	5/99.1
2,406,496	8/1946	Hambacher .....	D6/395
4,525,883	7/1985	Necowitz .....	5/93.1
5,038,427	8/1991	Golden .....	5/93.2
5,077,846	1/1992	Wheeler, III et al. ....	5/93.2
5,173,974	12/1992	Proano et al. .	

**OTHER PUBLICATIONS**

J.C. Penney, Spring/Summer 1992, p. 1004, bed #B at bottom.

Gander Mountain Catalog, Archery '93, Gander Mountain Inc., 1993, (p. 49).

*Primary Examiner*—Janice E. Seeger  
*Attorney, Agent, or Firm*—August E. Roehrig, Jr.

[57] **CLAIM**

The ornamental design for a convertible crib in adult bed configuration, as shown and described.

**DESCRIPTION**

FIG. 1 is a perspective view of a convertible crib in adult bed configuration;

FIG. 2 is a front elevational view;

FIG. 3 is a rear elevational view;

FIG. 4 is a right side elevational view with the left side being a mirror image thereof;

FIG. 5 is a top plan view thereof;

FIG. 6 is an enlarged cross-sectional view taken along lines 6—6 to better illustrate the contours thereof; and,

FIG. 7 is an enlarged cross-sectional view taken along lines 7—7 to better illustrate the contours thereof.

The side of the footboard not shown is plain and unadorned.

The broken line showing of a mattress in some of the figures is for illustrative purposes only, and forms no part of the claimed design.

**1 Claim, 6 Drawing Sheets**

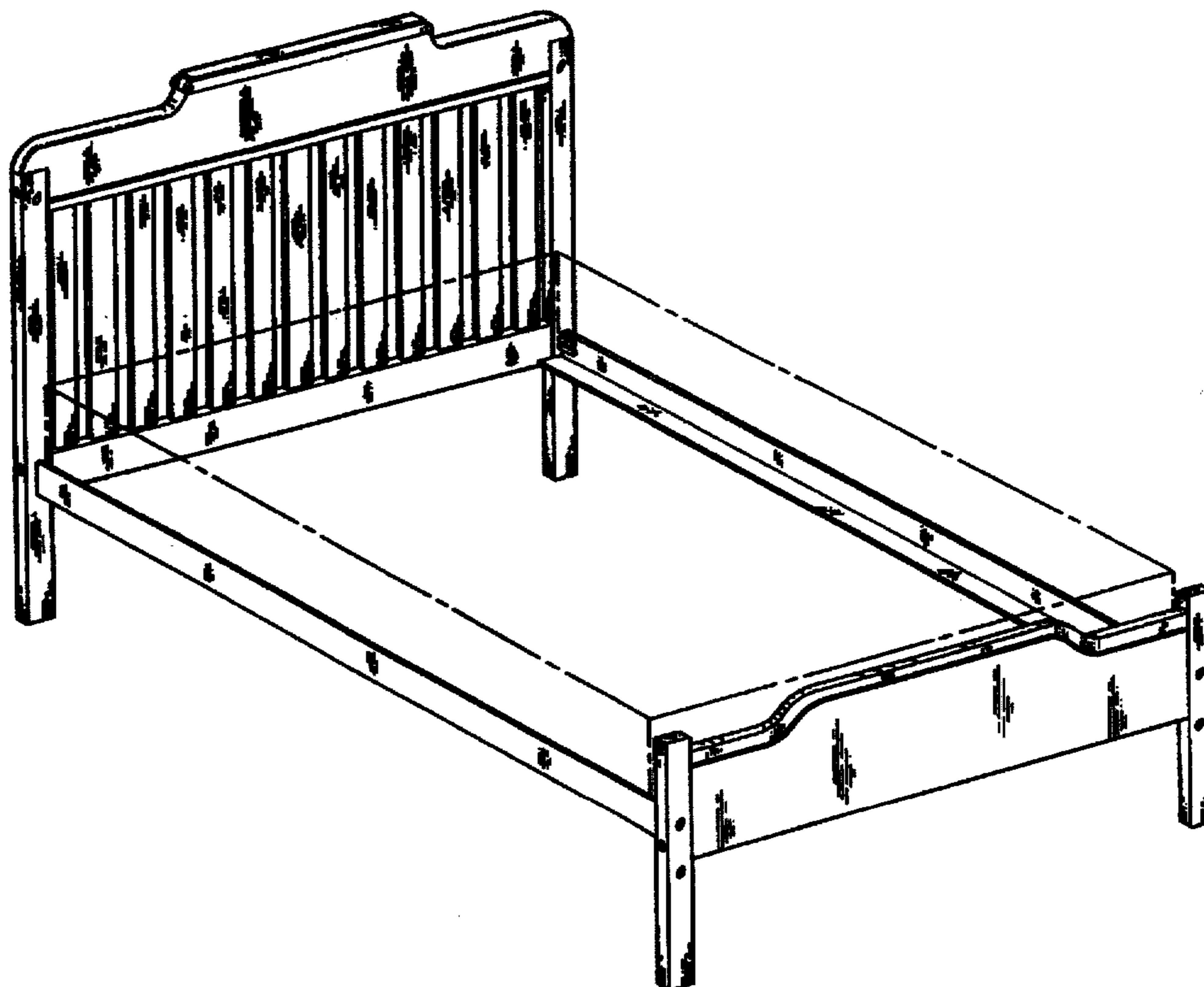

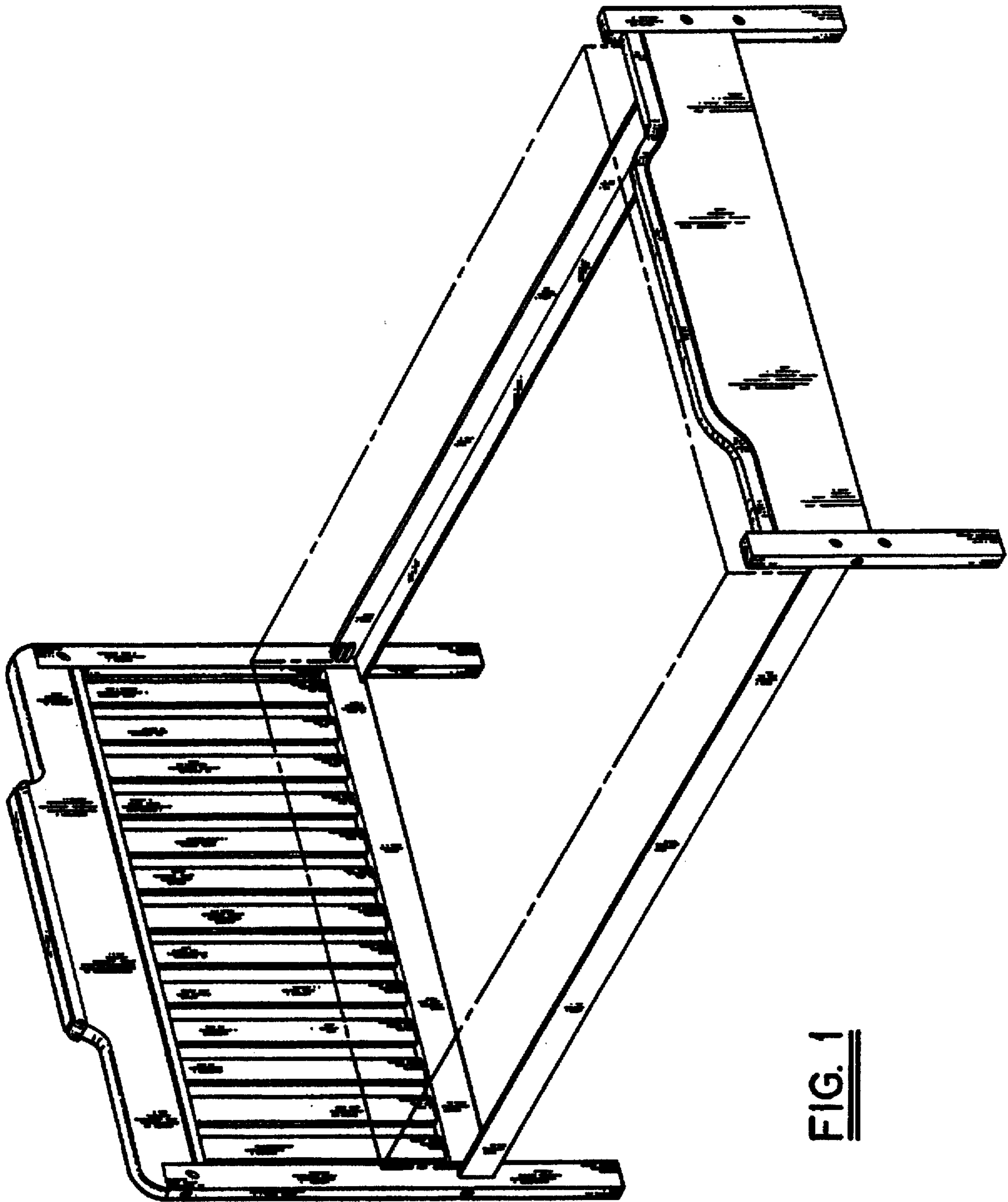

FIG. 1

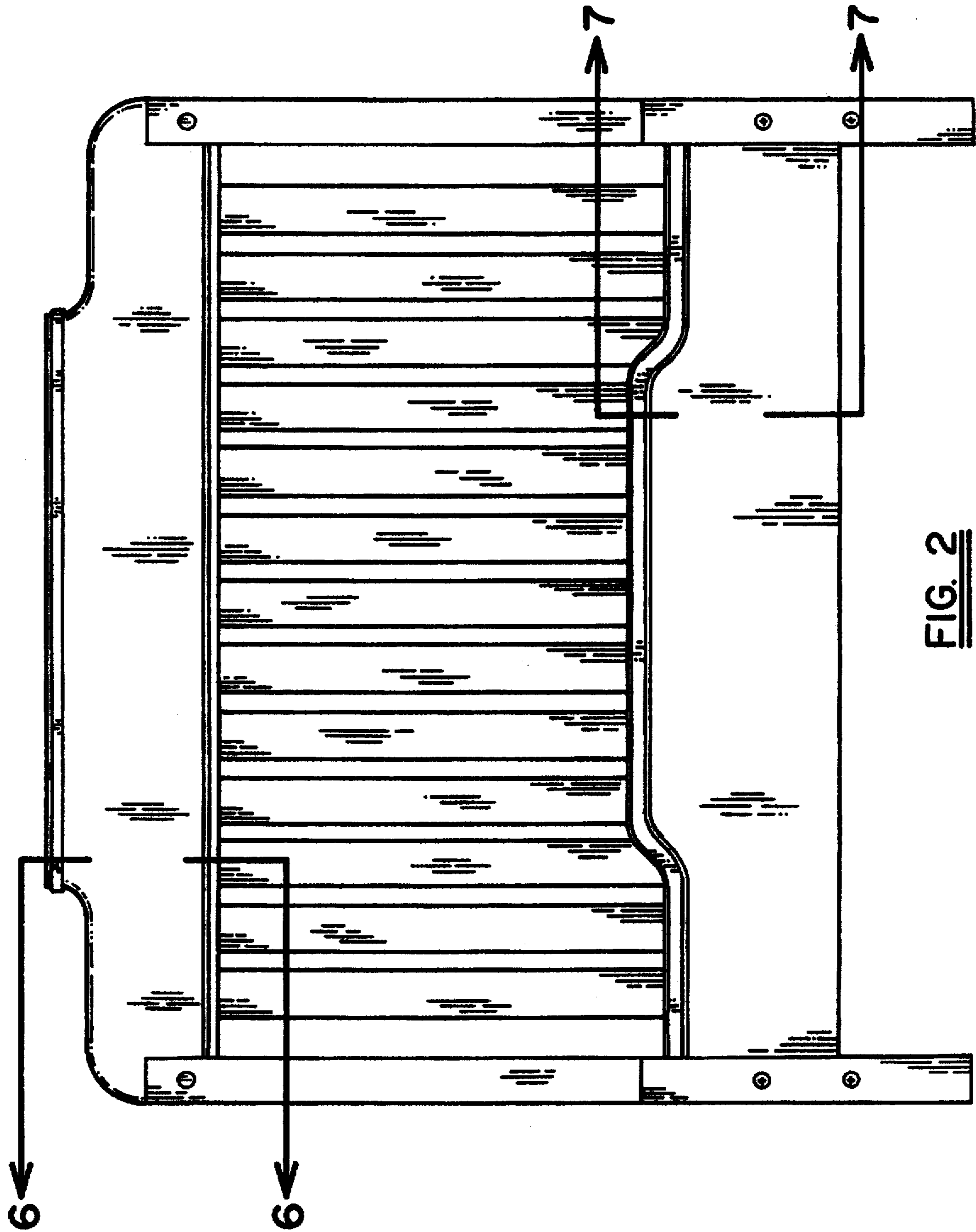

FIG. 2

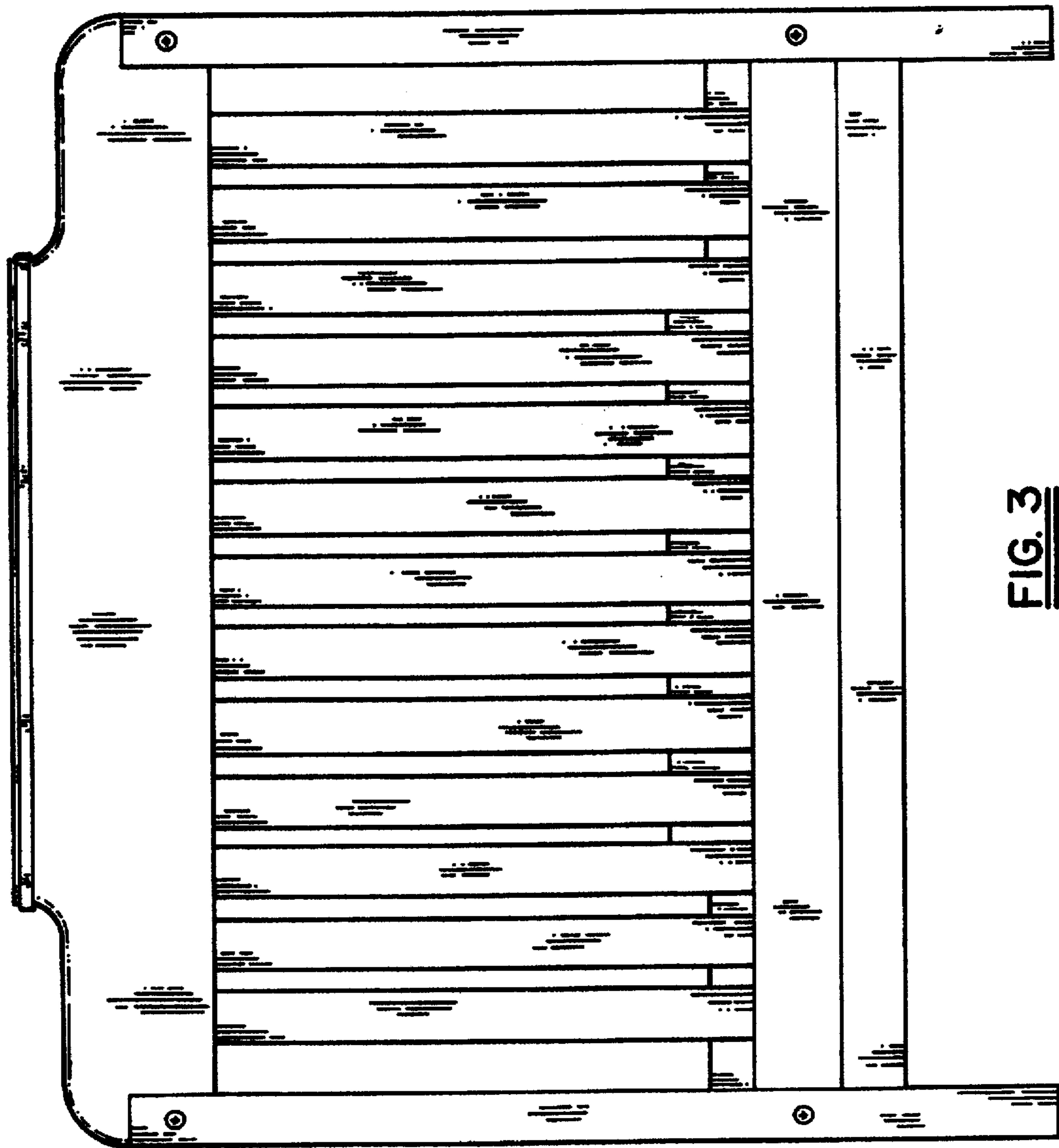

FIG. 3

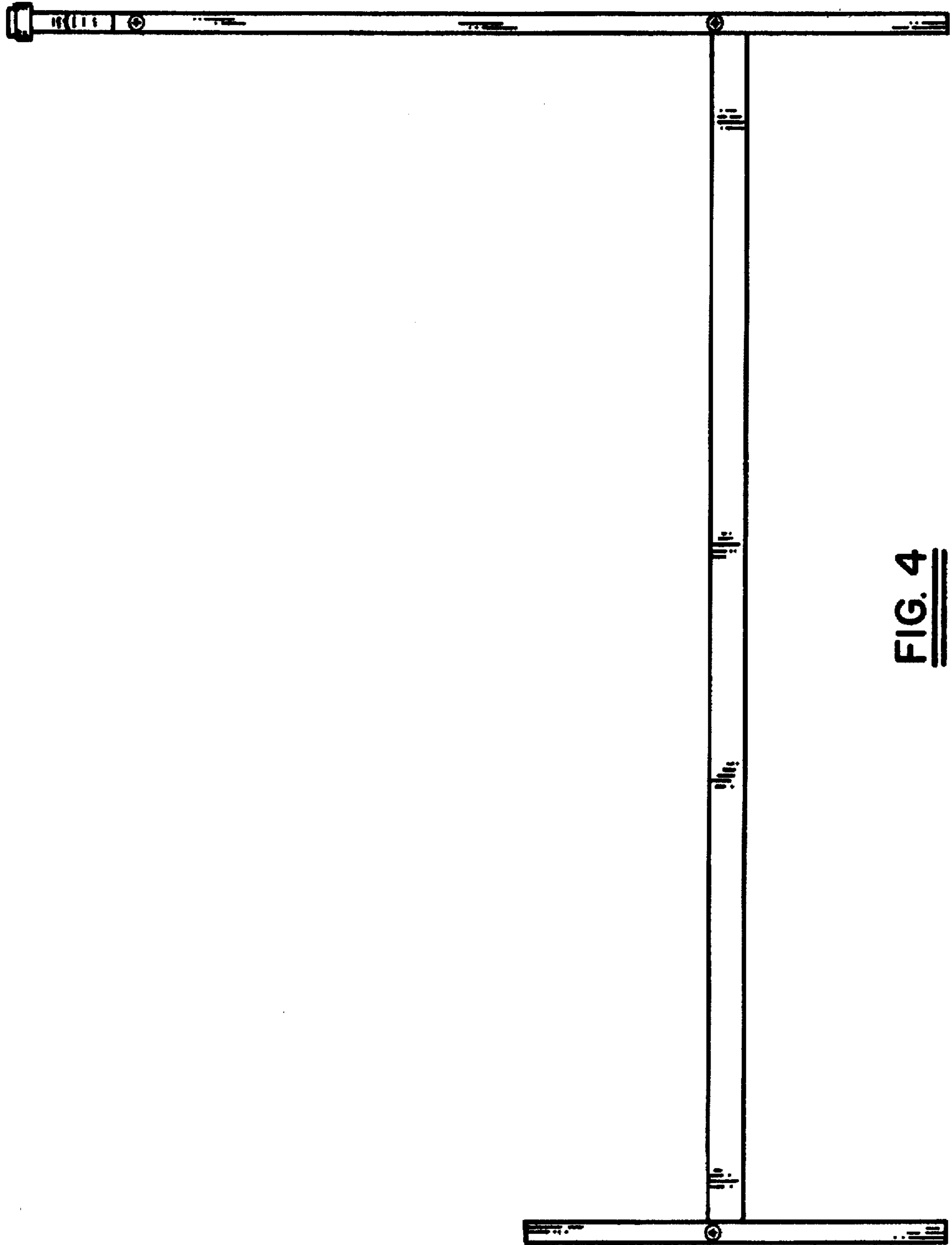

FIG. 4

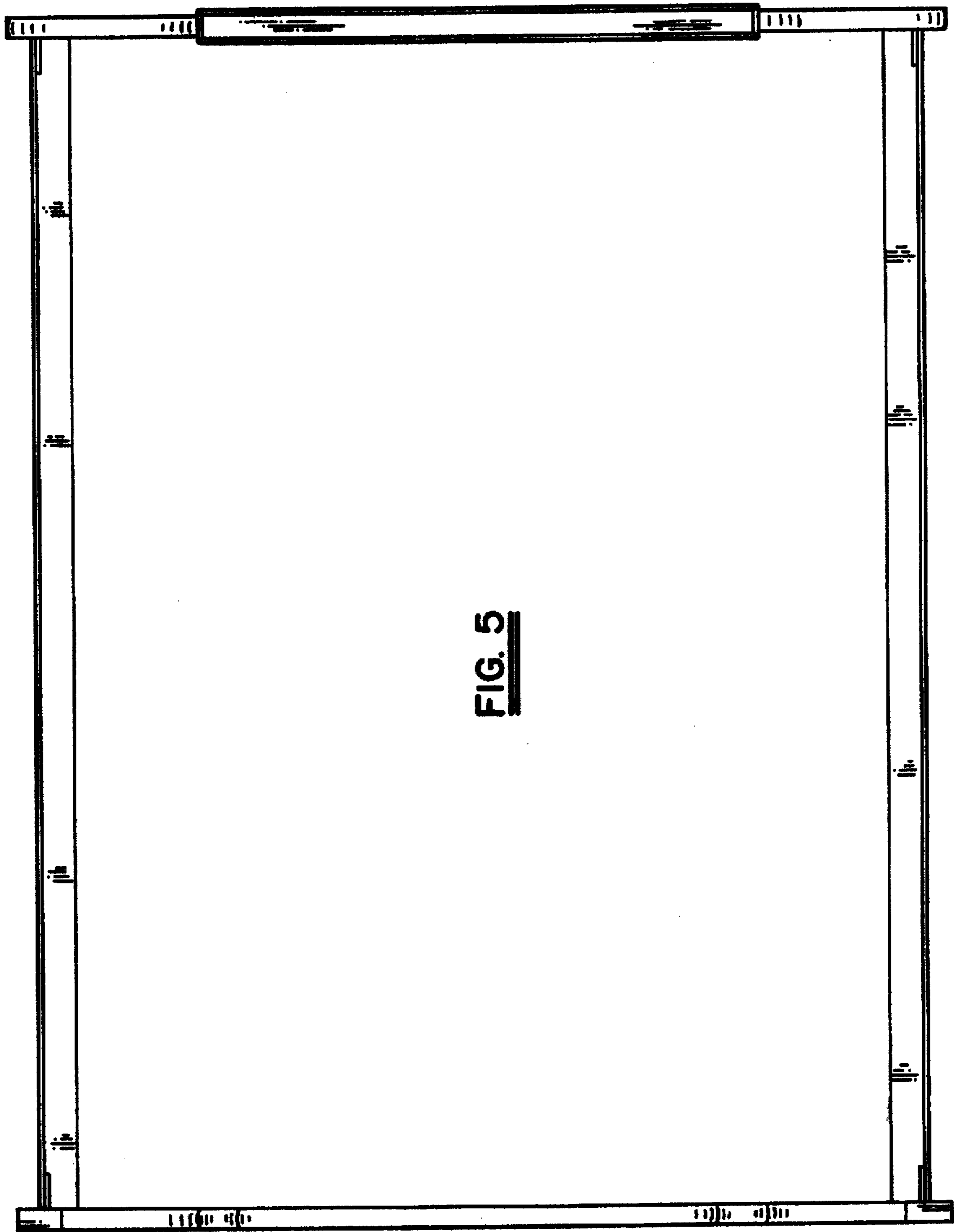

FIG. 5

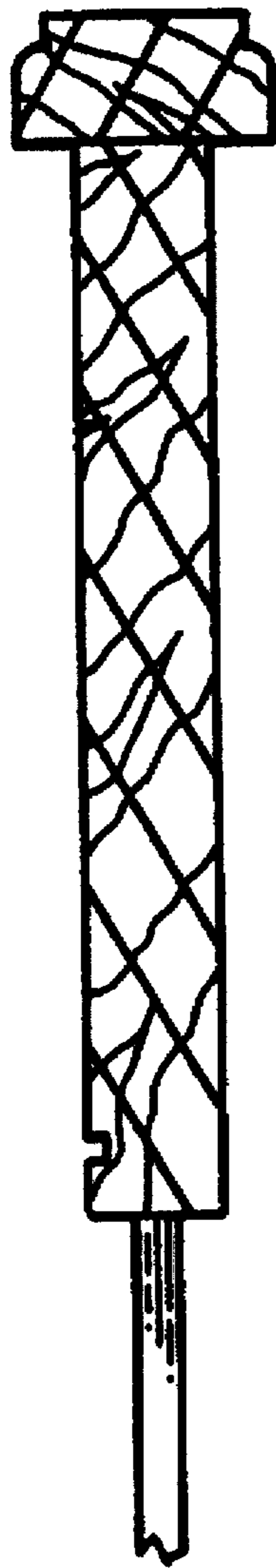

FIG. 6



FIG. 7