



US00D387200S

**United States Patent** [19]  
**Kühn**

[11] **Patent Number:** **Des. 387,200**

[45] **Date of Patent:** **\*\*Dec. 9, 1997**

[54] **HAND BAG**

[76] **Inventor:** **Norbert Kühn, Kölner Chaussee 53,  
25337 Elmshorn, Germany**

[\*\*] **Term:** **14 Years**

[21] **Appl. No.:** **51,256**

[22] **Filed:** **Mar. 7, 1996**

[51] **LOC (6) Cl.** ..... **03-01**

[52] **U.S. Cl.** ..... **D3/243; D3/245; D3/246**

[58] **Field of Search** ..... **D3/201, 230, 232,  
D3/233, 243, 244, 245, 246, 303, 901;  
D9/305; 150/118; 383/18, 81, 117**

[56] **References Cited**

**U.S. PATENT DOCUMENTS**

|            |        |           |       |           |
|------------|--------|-----------|-------|-----------|
| D. 67,310  | 5/1925 | Schoeberl | ..... | D3/246    |
| D. 153,239 | 3/1949 | Schwartz  | ..... | D3/232 X  |
| 514,183    | 2/1894 | Ferguson  | ..... | 383/81 X  |
| 602,723    | 4/1898 | Brown     | ..... | 383/81    |
| 2,288,996  | 7/1942 | Dubilier  | ..... | 383/117 X |
| 4,795,268  | 1/1989 | Jordá     | ..... | 383/117 X |
| 5,401,101  | 3/1995 | Wang      | ..... | 383/117 X |

**FOREIGN PATENT DOCUMENTS**

|       |        |         |       |         |
|-------|--------|---------|-------|---------|
| 58361 | 3/1913 | Hungary | ..... | 383/117 |
|-------|--------|---------|-------|---------|

*Primary Examiner*—Louis S. Zarfaz

*Assistant Examiner*—Monica A. Weingart

*Attorney, Agent, or Firm*—Henry M. Feiereisen

[57] **CLAIM**

The ornamental design for a hand bag, as shown and described.

**DESCRIPTION**

FIG. 1 is a top, front and side perspective view of a hand bag, showing my new design;  
 FIG. 2 is a top view thereof;  
 FIG. 3 is a front elevational view thereof;  
 FIG. 4 is a rear elevational view thereof;  
 FIG. 5 is a bottom view thereof;  
 FIG. 6 is a side elevational view thereof, with the opposite side being a mirror image thereof;  
 FIG. 7 is a top, front and side perspective view of a variation of the hand bag of FIG. 1;  
 FIG. 8 is a top view thereof;  
 FIG. 9 is a front elevational view thereof;  
 FIG. 10 is a rear elevational view thereof;  
 FIG. 11 is a bottom view thereof;  
 FIG. 12 is a side elevational view thereof, with the opposite side being a mirror image thereof;  
 FIG. 13 is a top, front and side perspective view of a second variation of the hand bag of FIG. 1;  
 FIG. 14 is a top view thereof;  
 FIG. 15 is a front elevational view thereof;  
 FIG. 16 is a rear elevational view thereof;  
 FIG. 17 is a bottom view thereof;  
 FIG. 18 is a side elevational view thereof, with the opposite side being a mirror image thereof and,  
 FIG. 19 is a top, front and side perspective view of a third variation of the hand bag of FIG. 1.

**1 Claim, 7 Drawing Sheets**

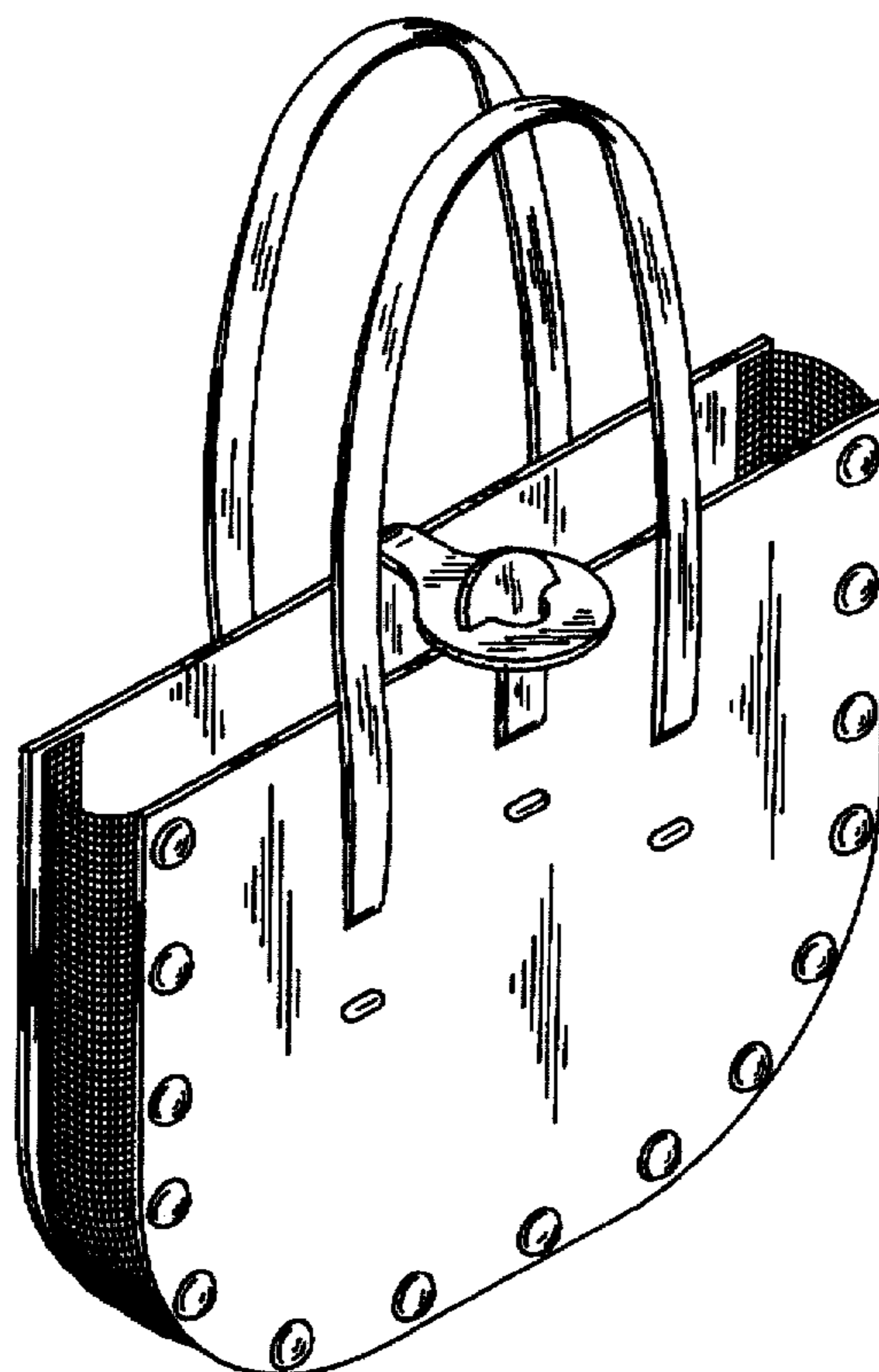

FIG. 2

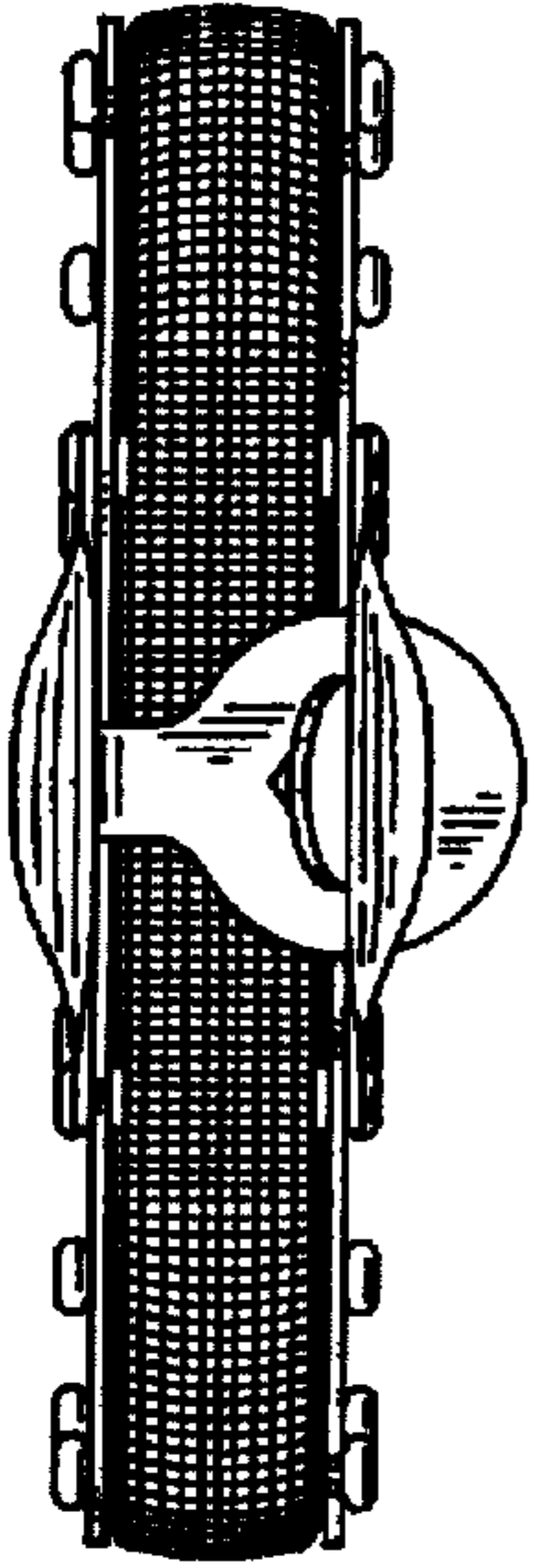

FIG. 3

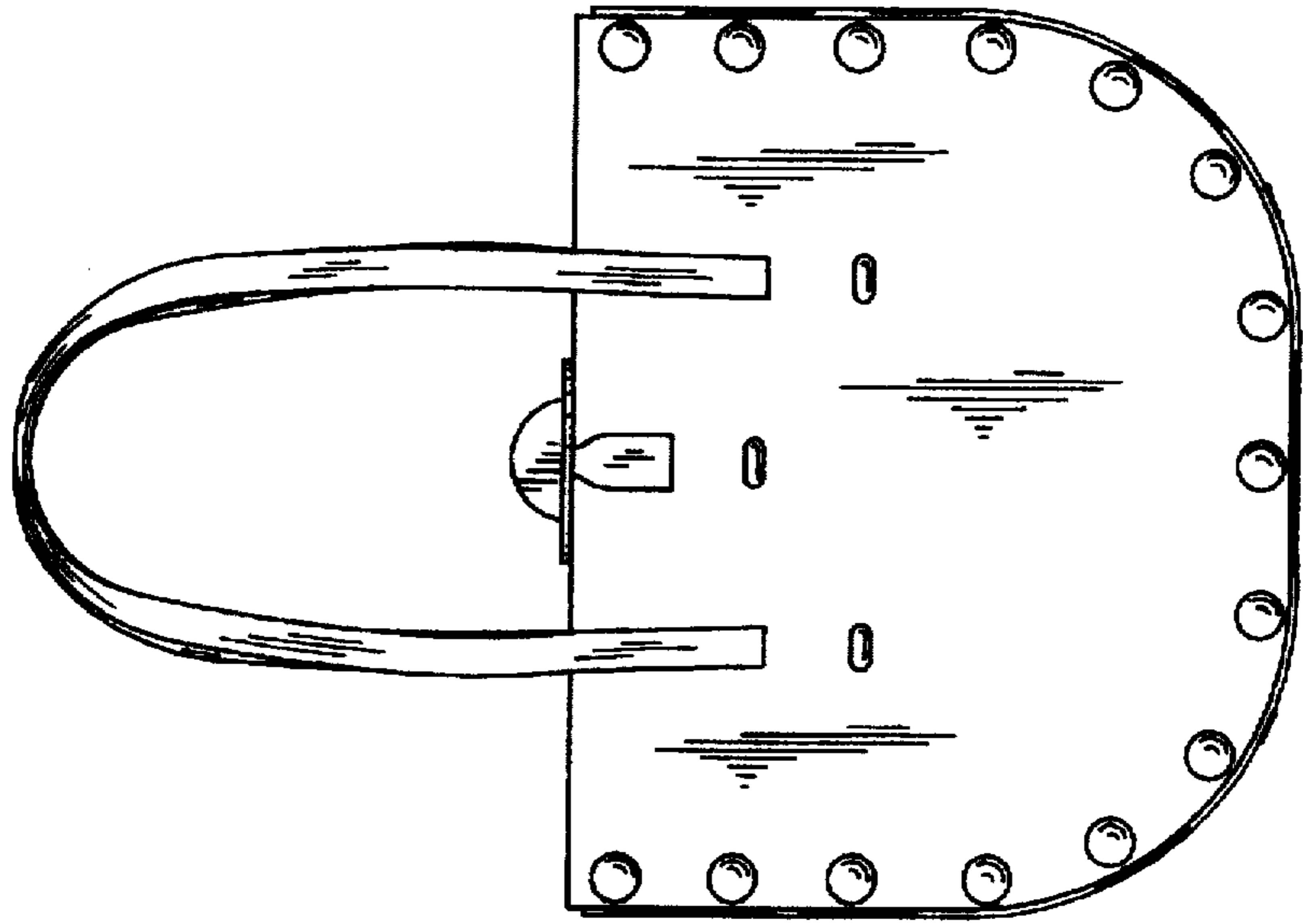

FIG. 1

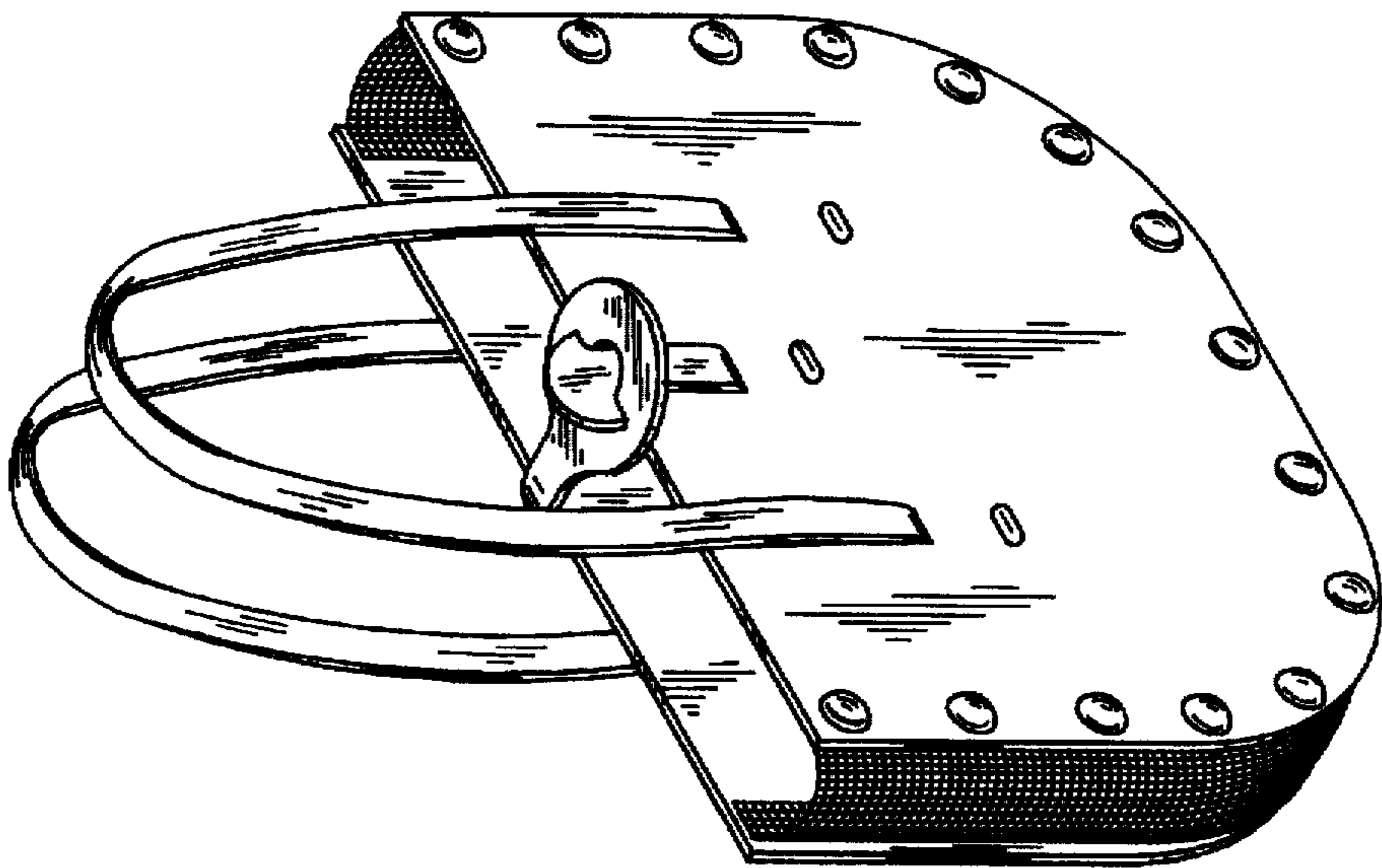

FIG. 6

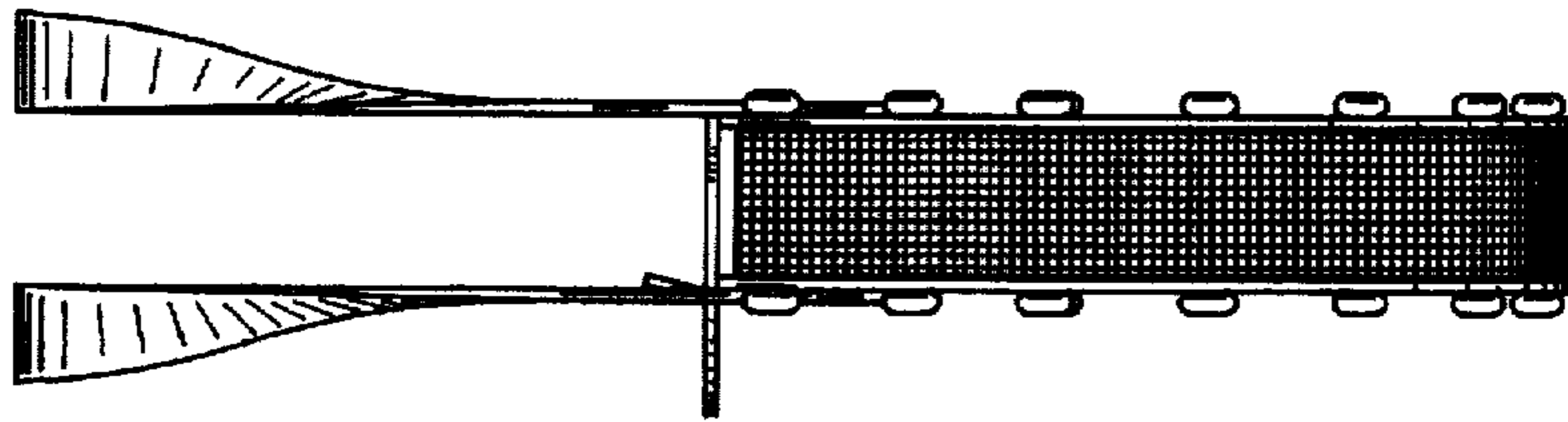

FIG. 4

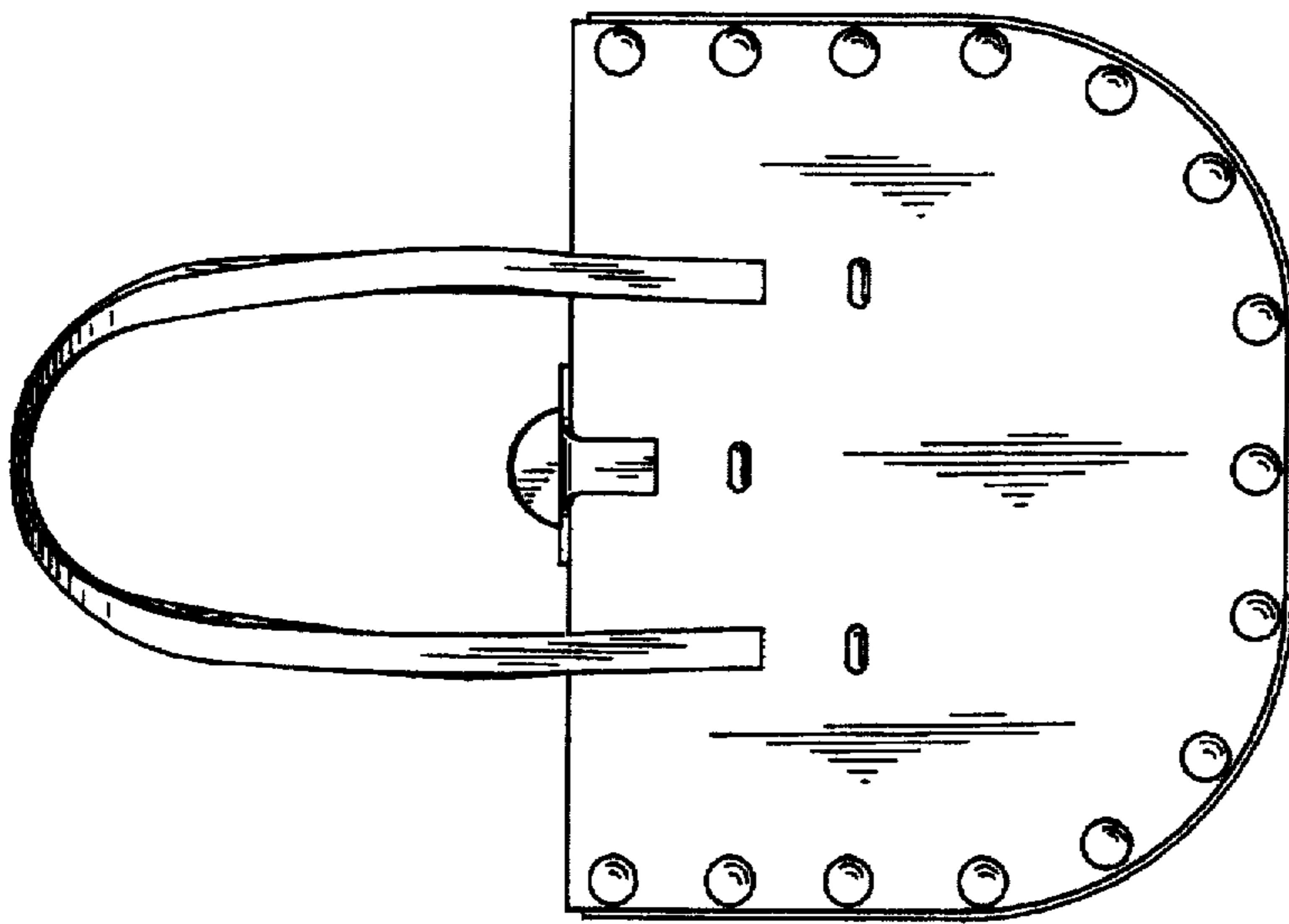

FIG. 5

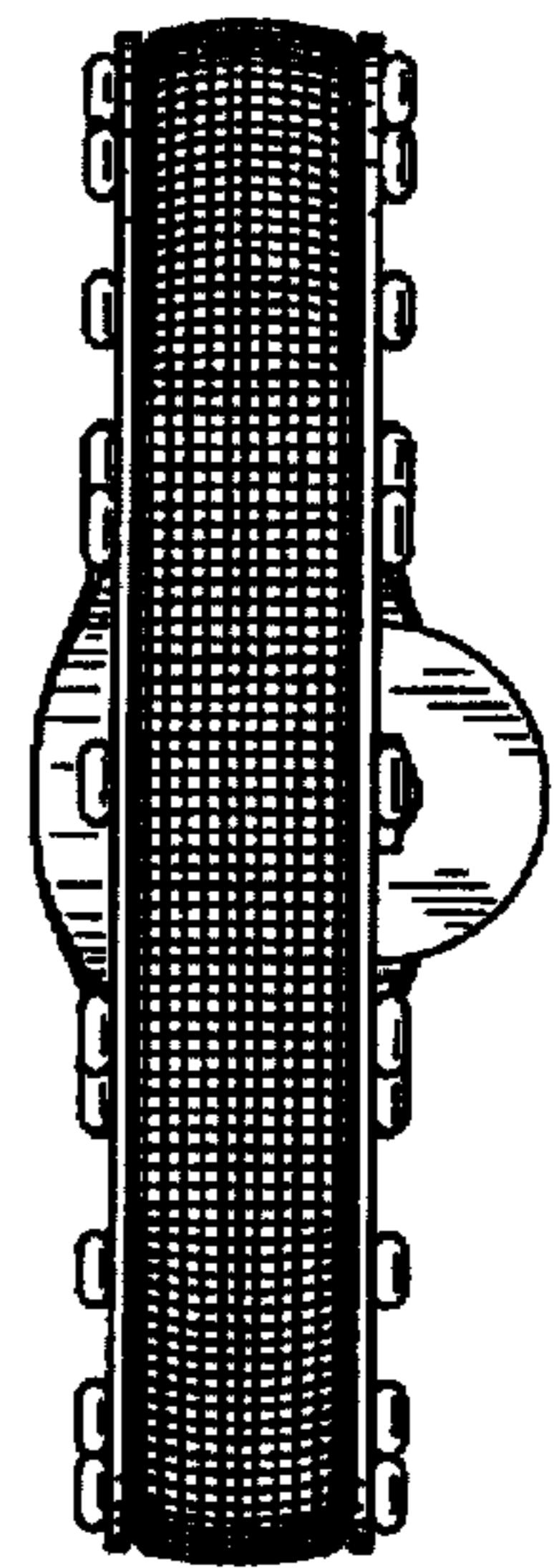

FIG. 8

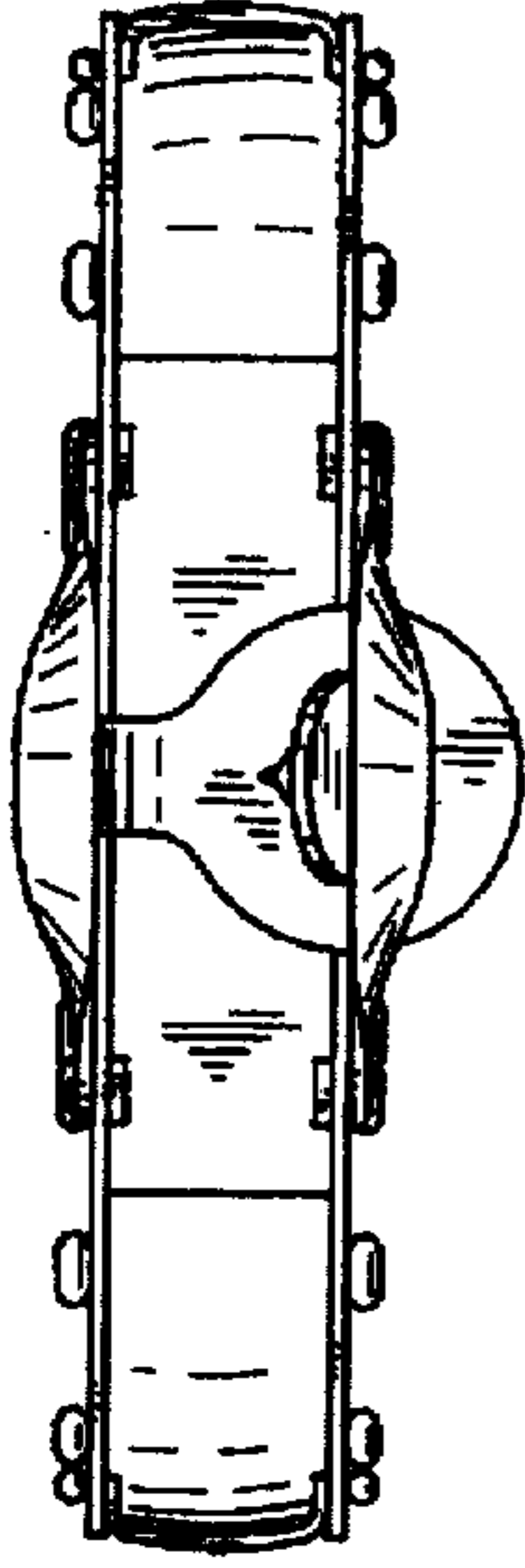

FIG. 9

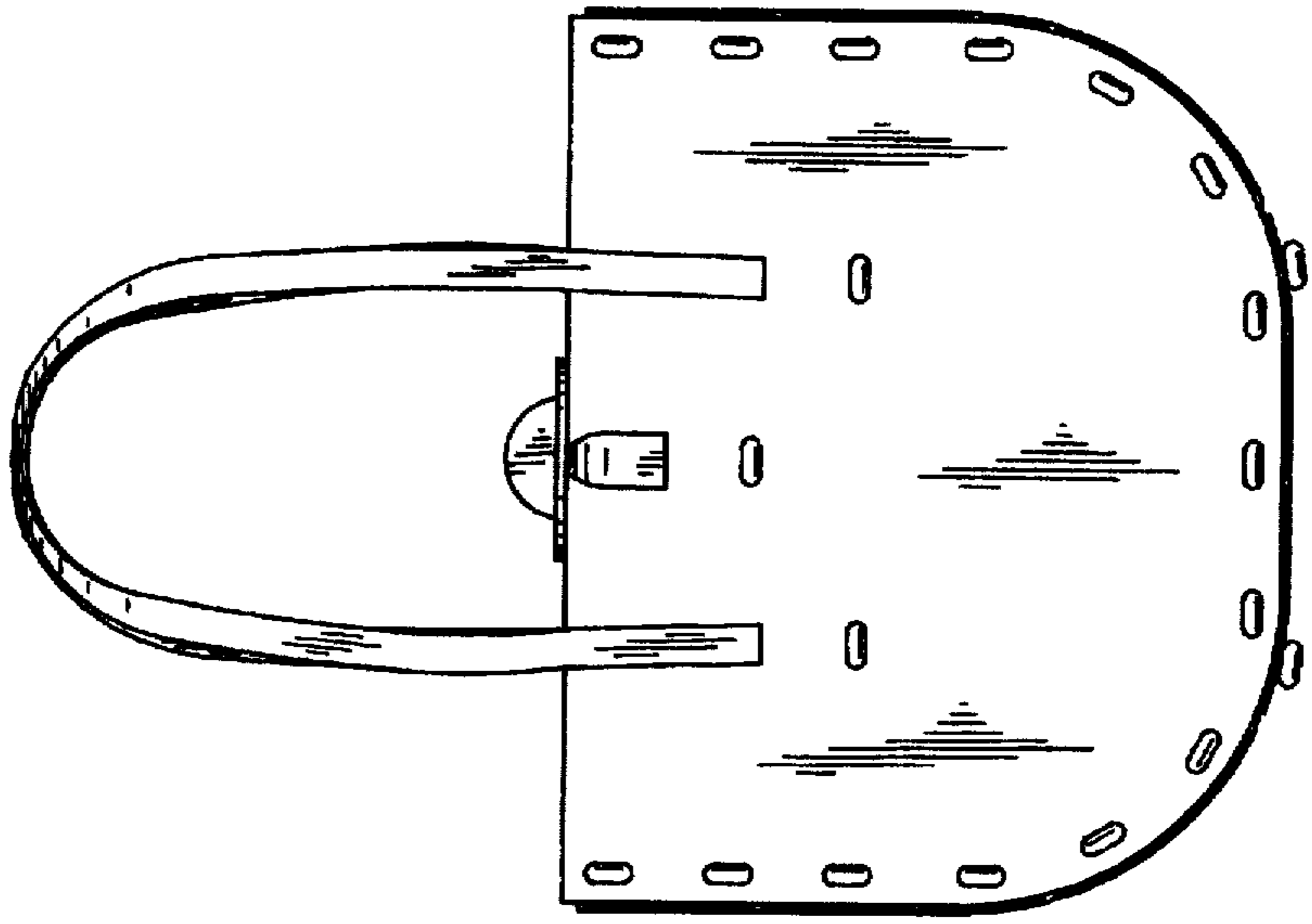

FIG. 7

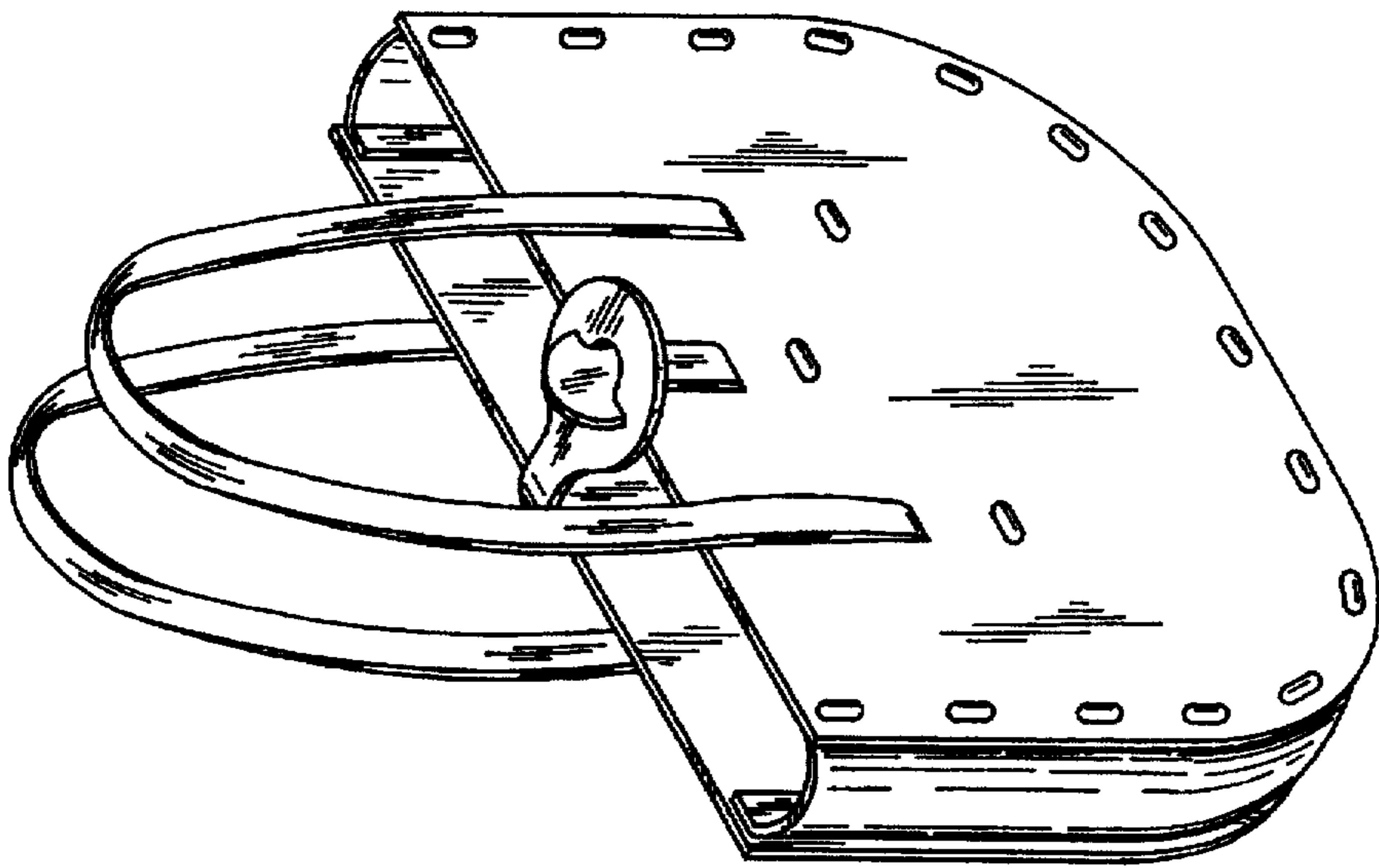

FIG. 12

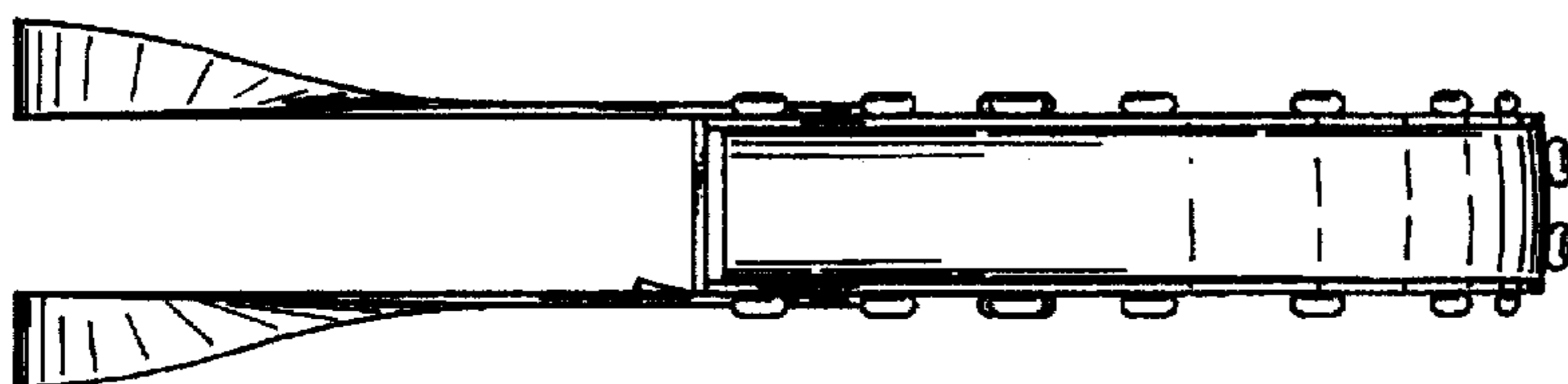

FIG. 10

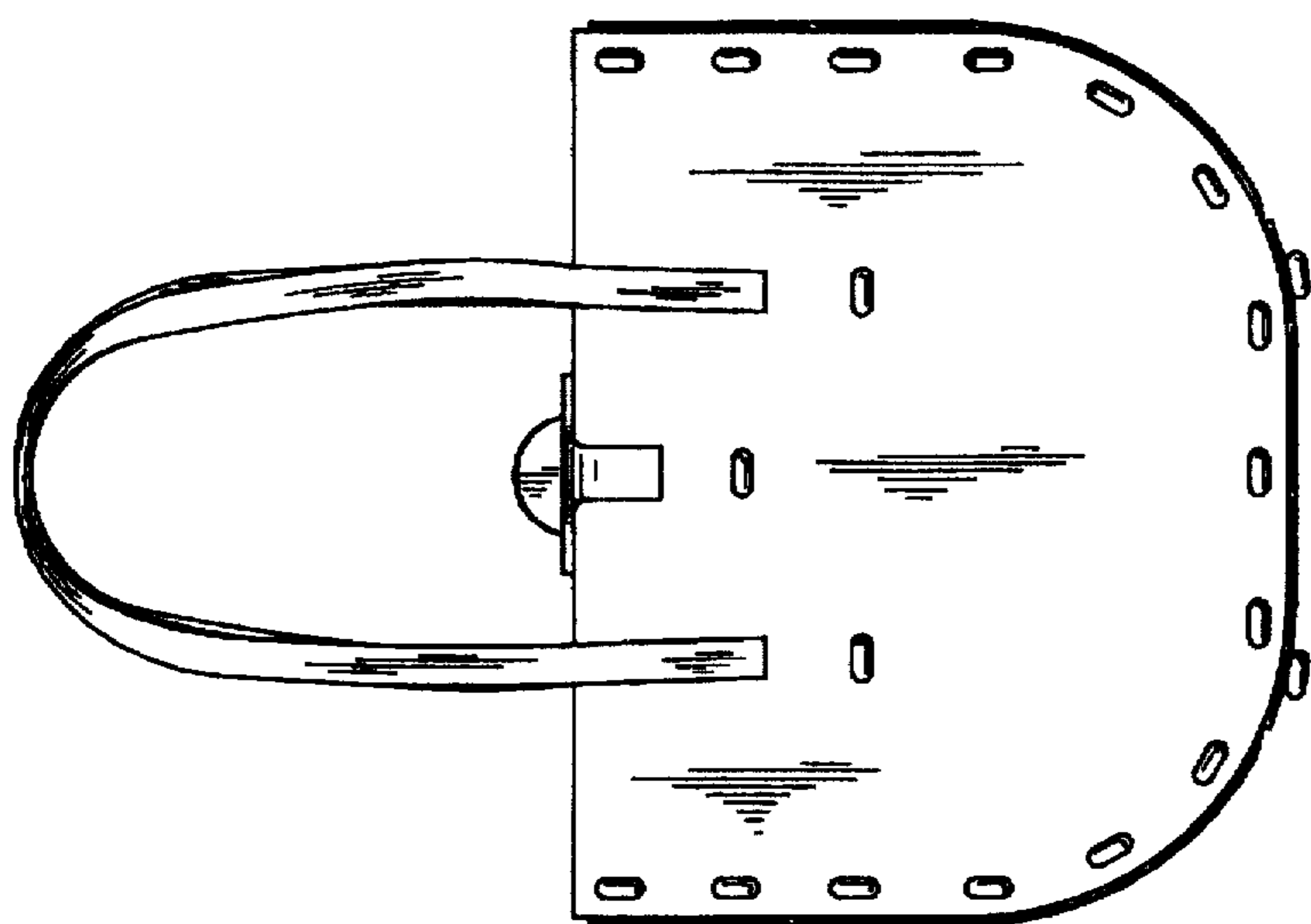

FIG. 11

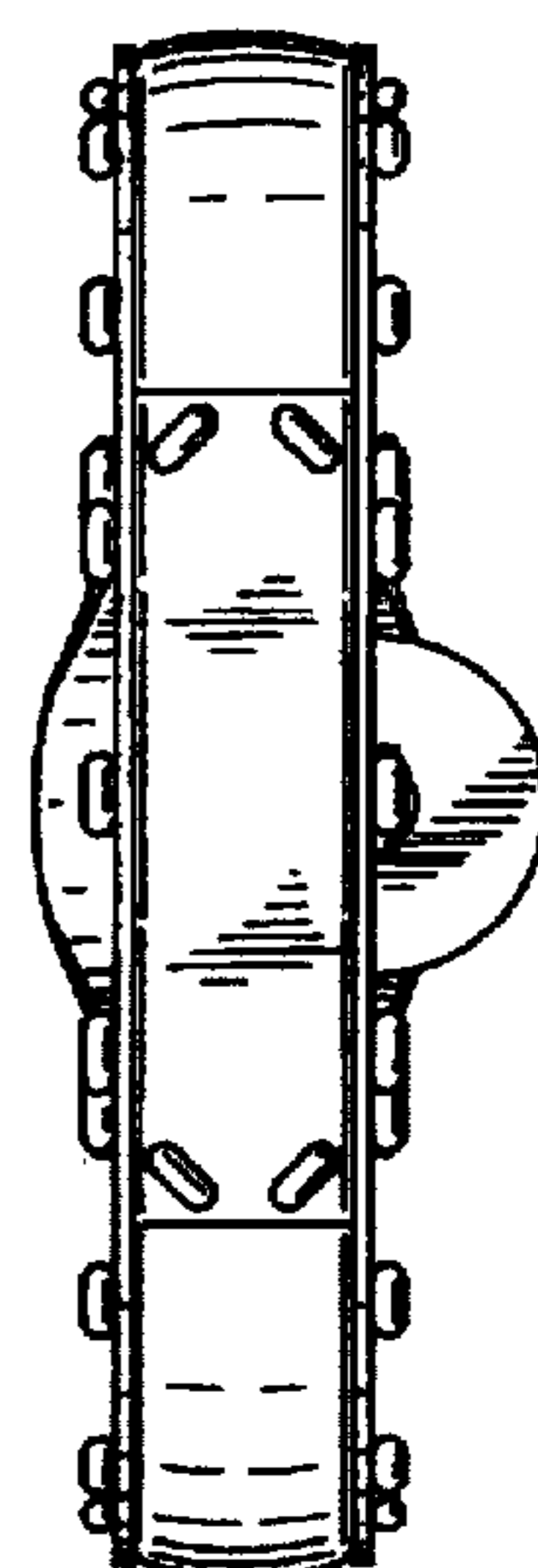

FIG. 14

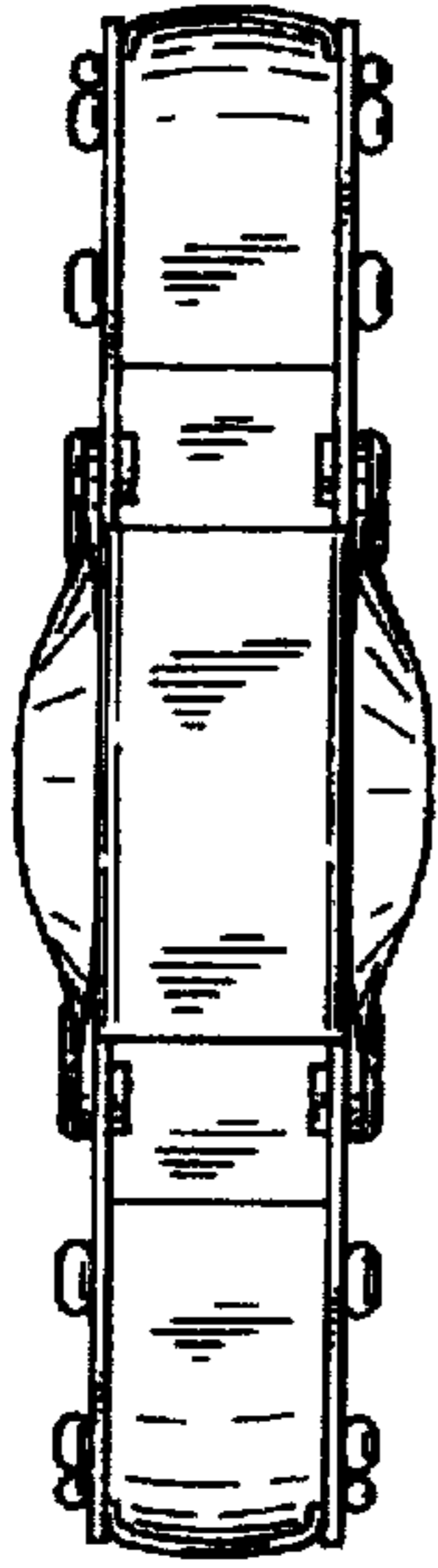

FIG. 15

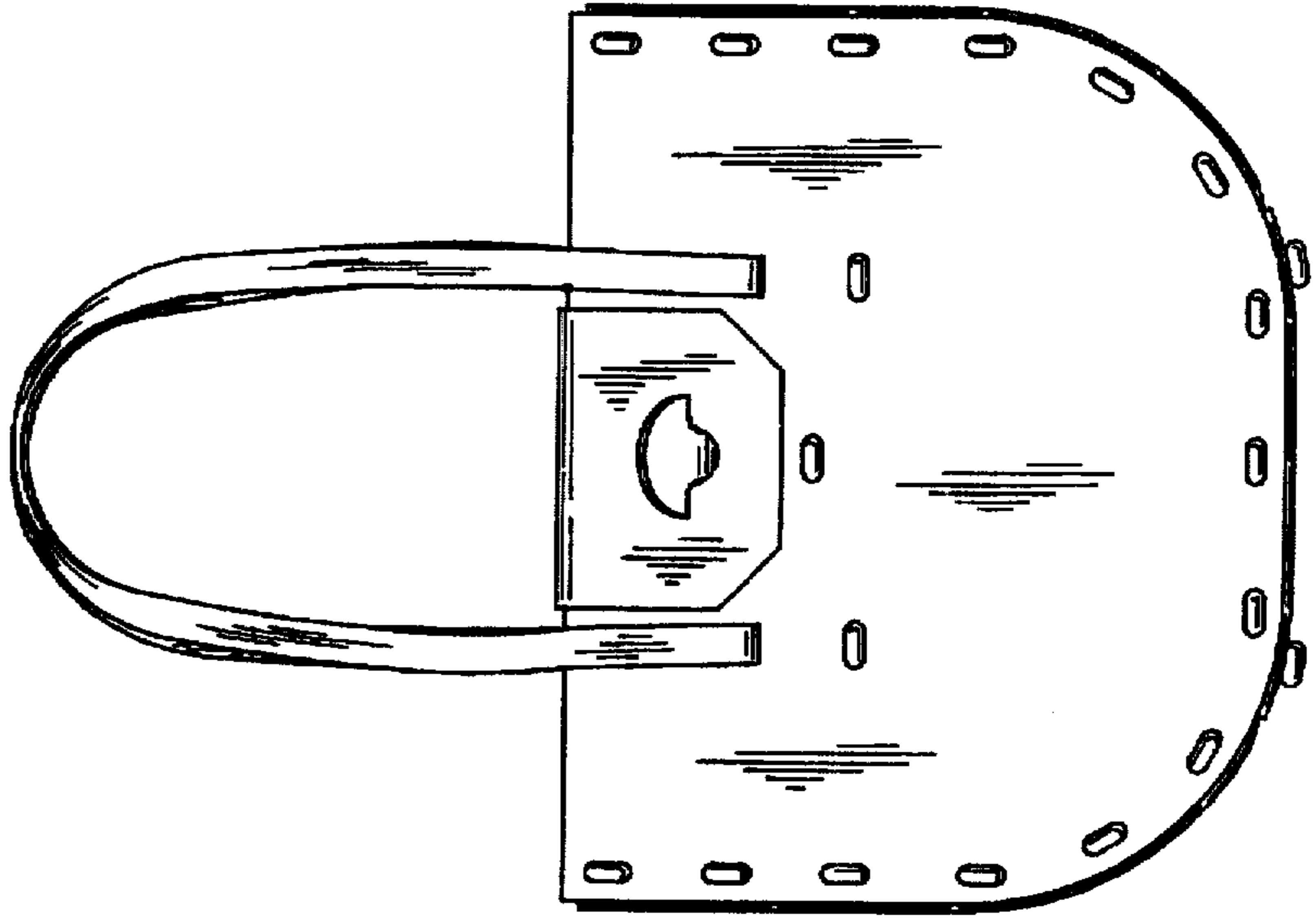

FIG. 13

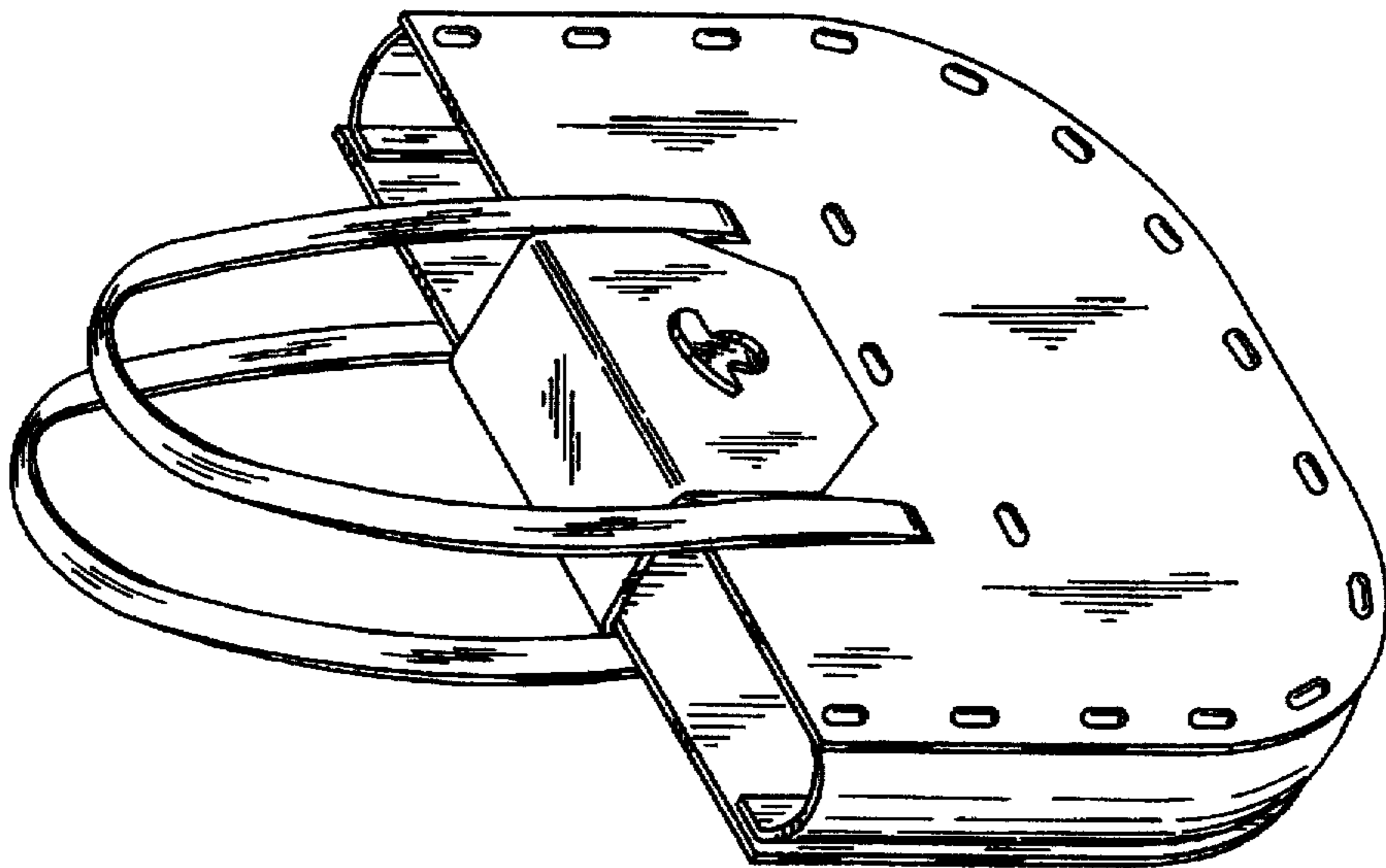

FIG. 18

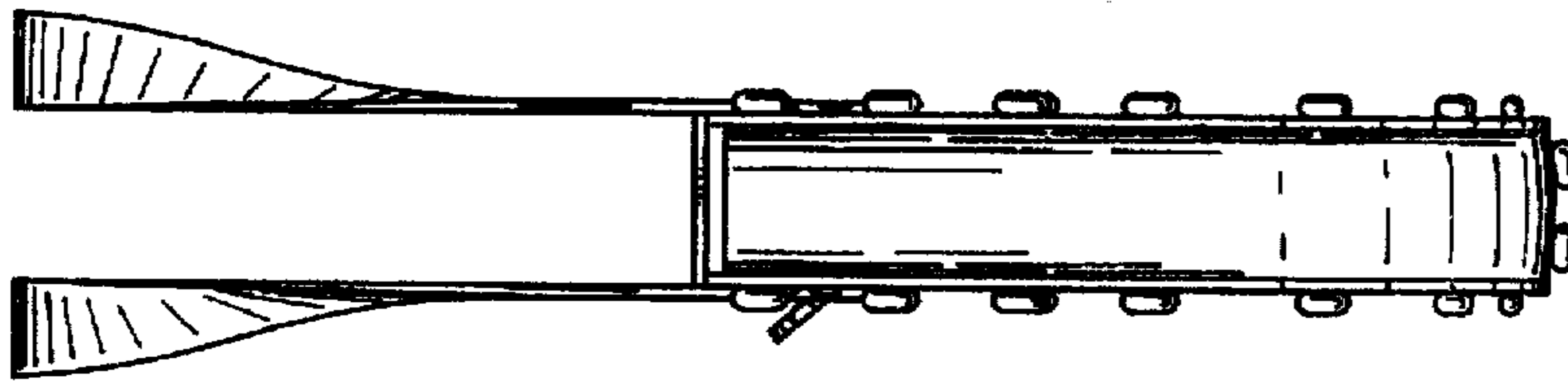

FIG. 16

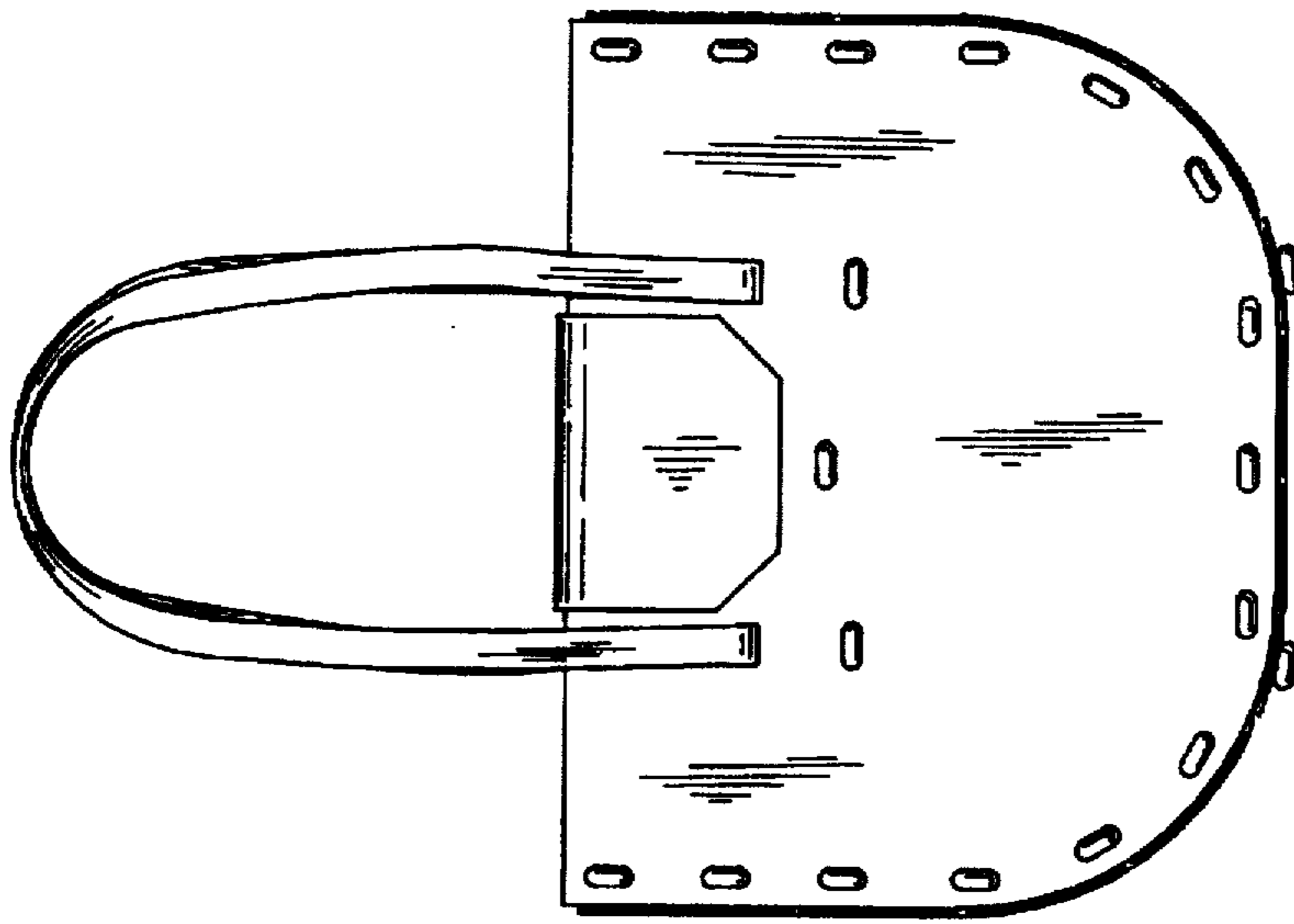

FIG. 17

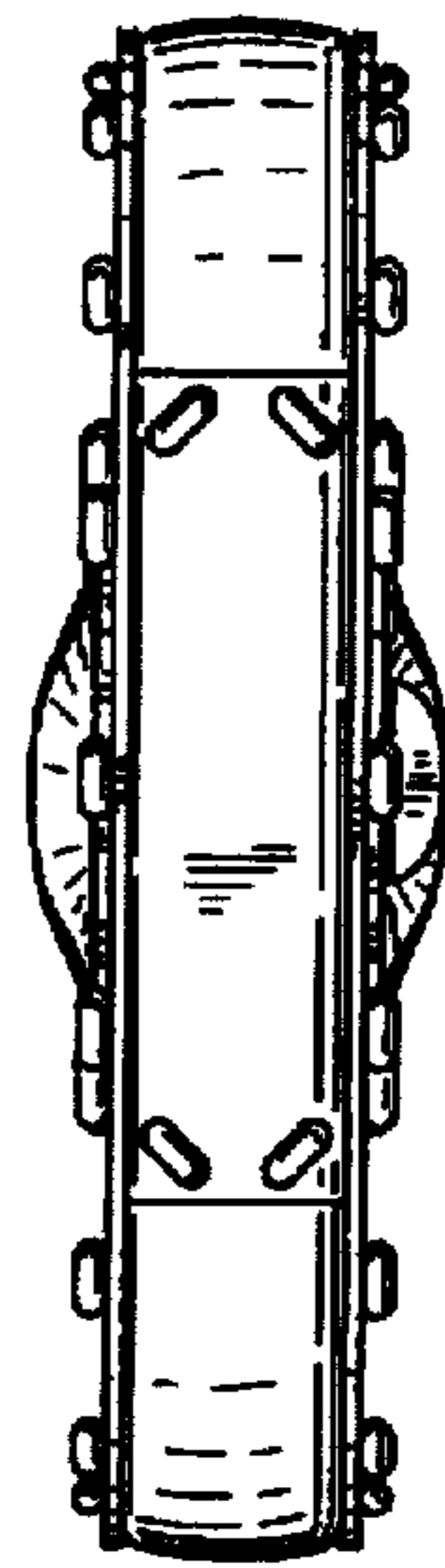

FIG. 19

