



US00D387185S

**United States Patent** [19]  
**Gelink**

[11] **Patent Number: Des. 387,185**  
[45] **Date of Patent: \*\*Dec. 9, 1997**

- [54] **ICE CREAM CONFECTION**
- [75] **Inventor: Erik-Jan Gelink, Amsterdam, Netherlands**
- [73] **Assignee: Good Humor-Breyers Ice Cream, Division of Conopco, Inc., Green Bay, Wis.**
- [\*\*] **Term: 14 Years**
- [21] **Appl. No.: 54,818**
- [22] **Filed: May 22, 1996**
- [30] **Foreign Application Priority Data**  
Nov. 29, 1995 [WO] WIPO ..... DM 034804
- [51] **LOC (6) Cl. .... 01-01**
- [52] **U.S. Cl. .... D1/106; D1/109**
- [58] **Field of Search .... D1/106, 108, 109; D19/53; D21/166, 155; 426/104, 101, 249**
- [56] **References Cited**  
**U.S. PATENT DOCUMENTS**  
D. 309,366 7/1990 Concepcion et al. .... D1/106  
D. 374,542 10/1996 Chin-Hsieh et al. .... D1/109

729,248 5/1903 Yeager et al. .... D1/106 X  
2,053,238 9/1936 Dulany ..... D1/106 X

**OTHER PUBLICATIONS**

S&S Catalog, 1995 p. 48 Element A eraser on bottom of page.

*Primary Examiner*—Susan J. Lucas  
*Assistant Examiner*—Pamela Burgess  
*Attorney, Agent, or Firm*—James J. Farrell

[57] **CLAIM**

The ornamental design for an ice cream confection, as shown and described.

**DESCRIPTION**

FIG. 1 is a top perspective view of an ice cream confection showing my new design;  
FIG. 2 is a top plan view thereof;  
FIG. 3 is a bottom plan view thereof;  
FIG. 4 is a front elevational view thereof;  
FIG. 5 is a rear elevational view thereof;  
FIG. 6 is a right side elevational view thereof; and,  
FIG. 7 is a left side elevational view thereof.

**1 Claim, 2 Drawing Sheets**

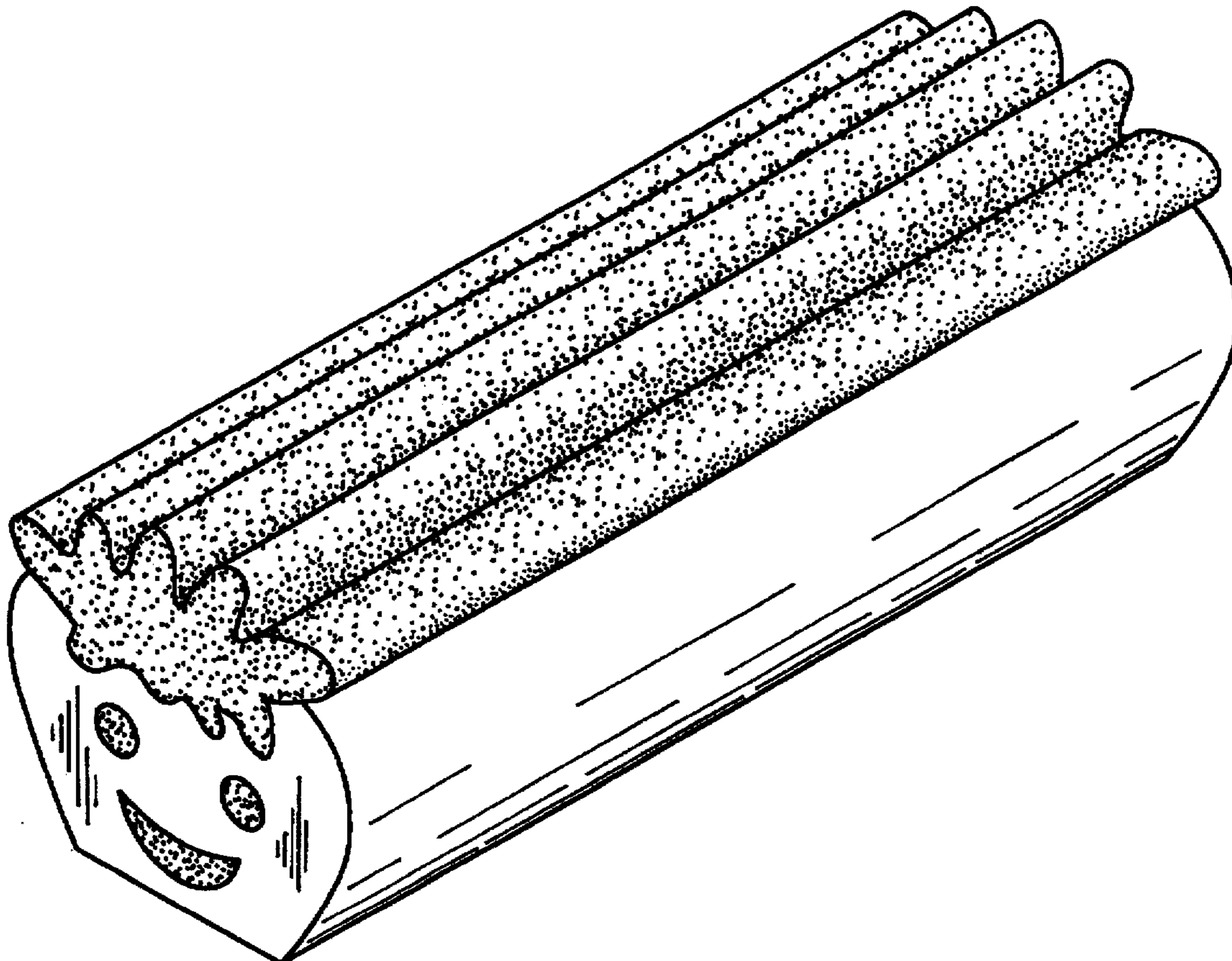

FIG. 1

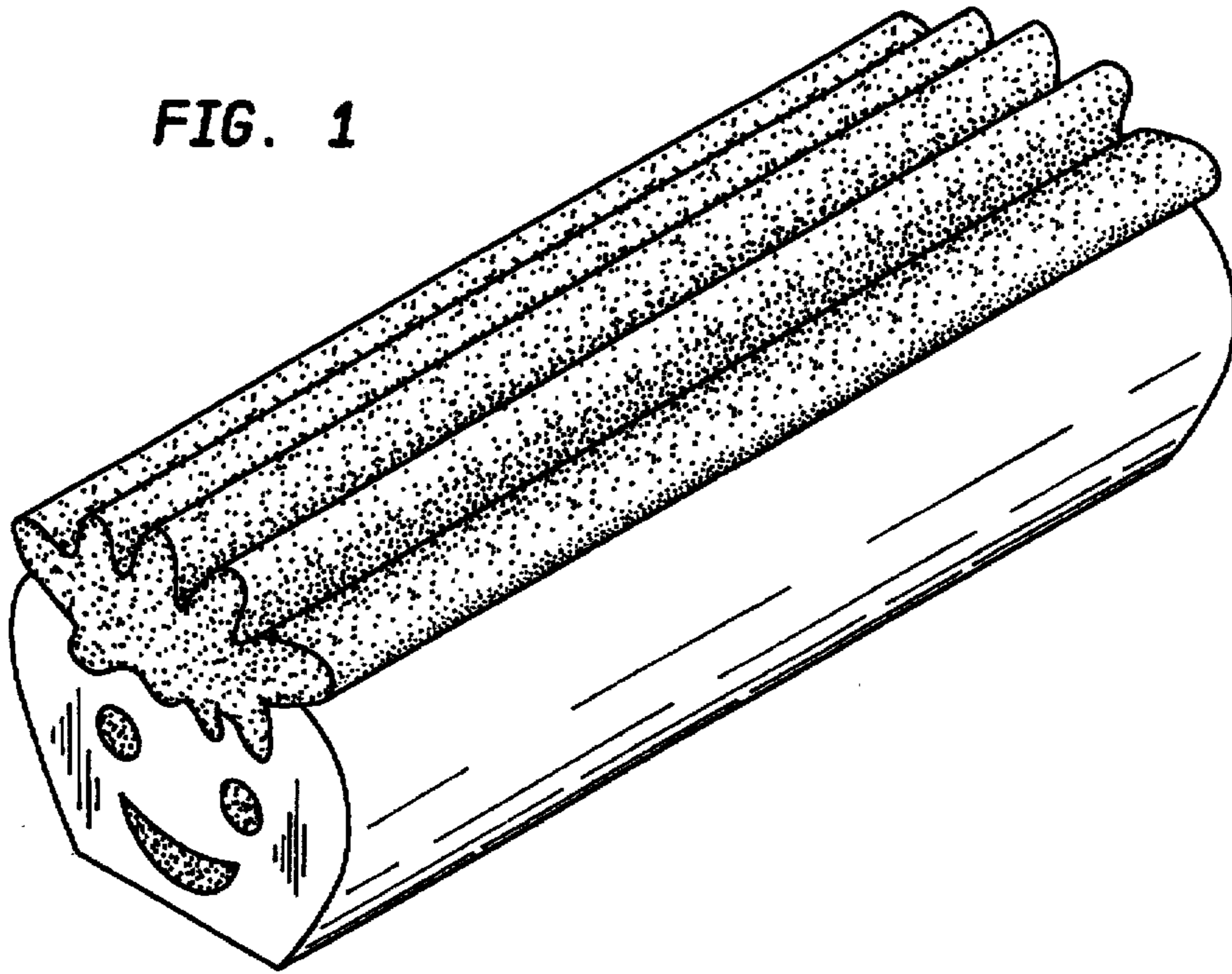

FIG. 2

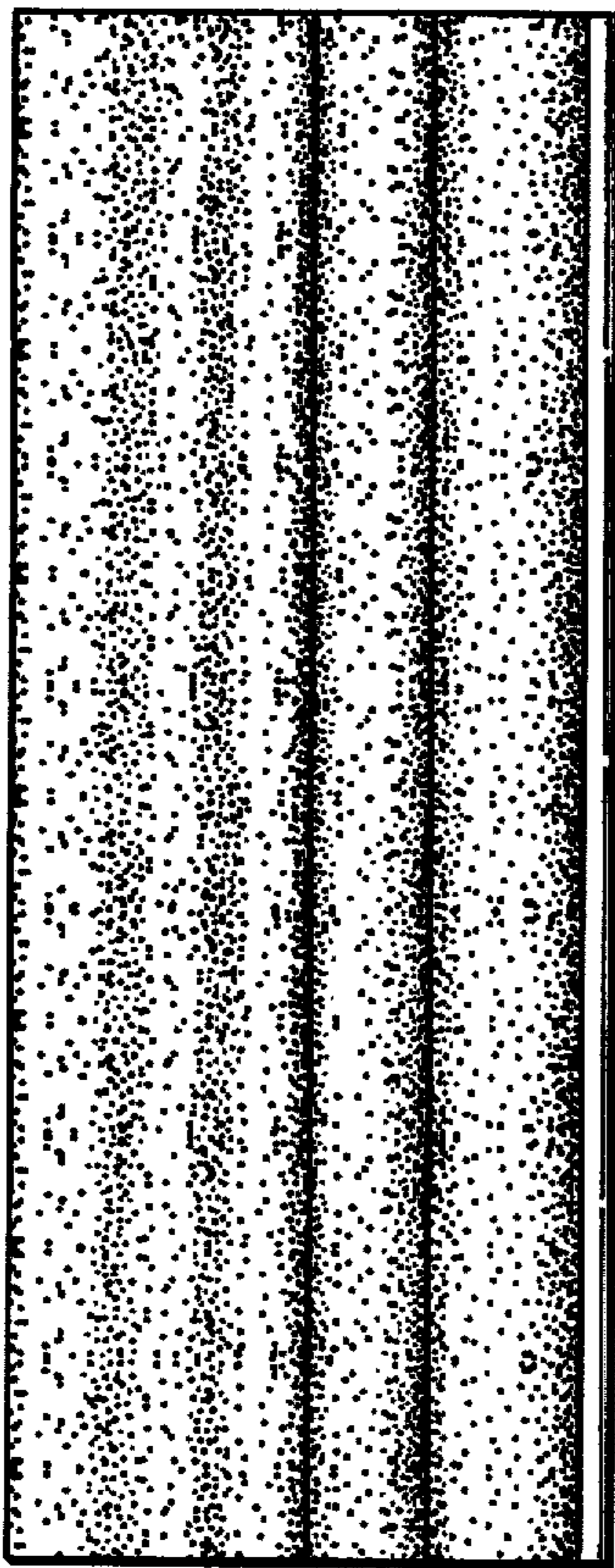

FIG. 3

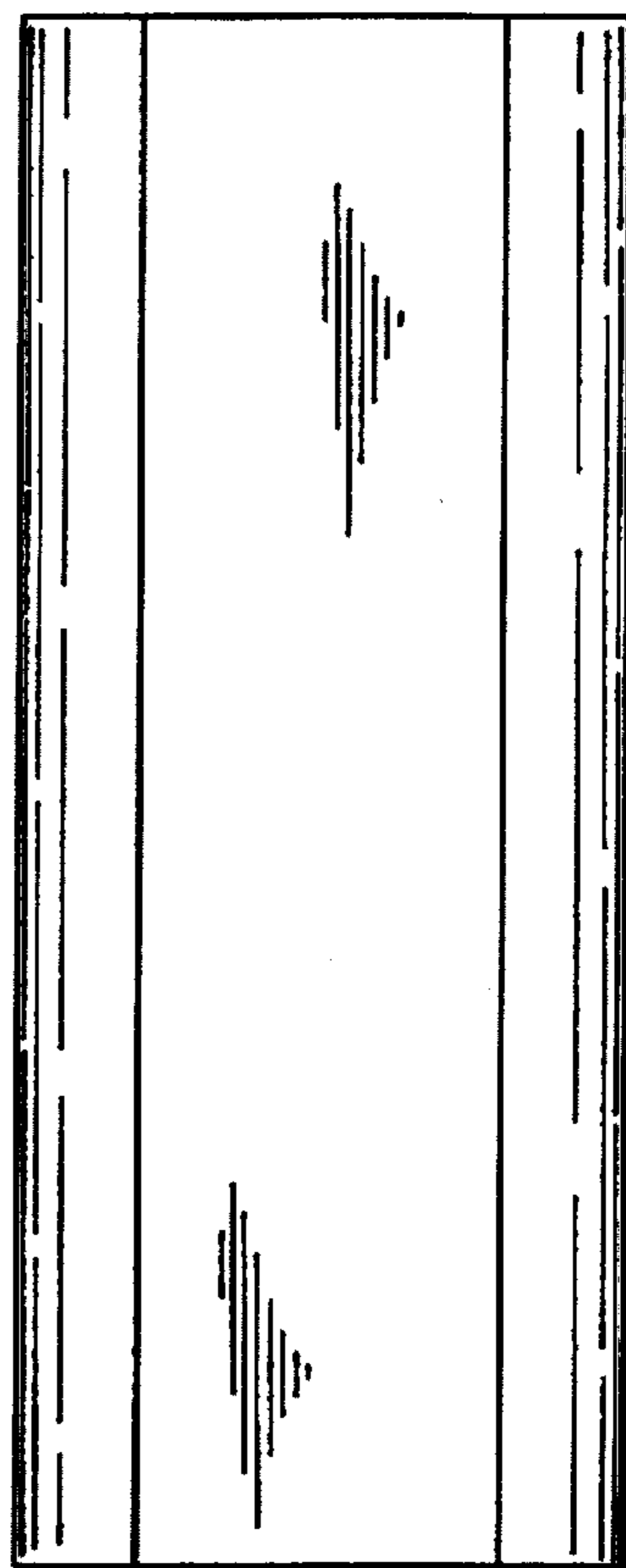

FIG. 4

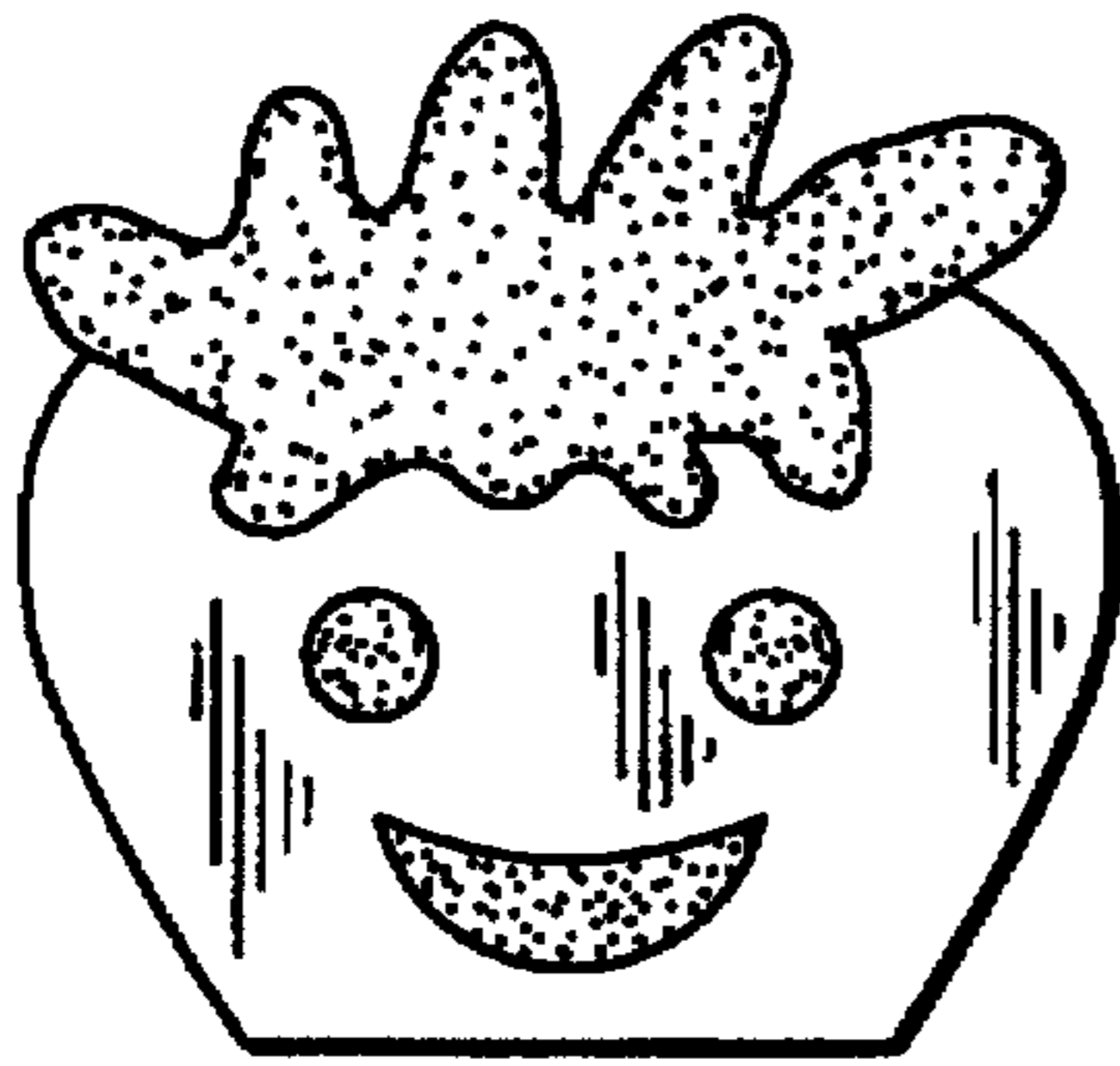

FIG. 5

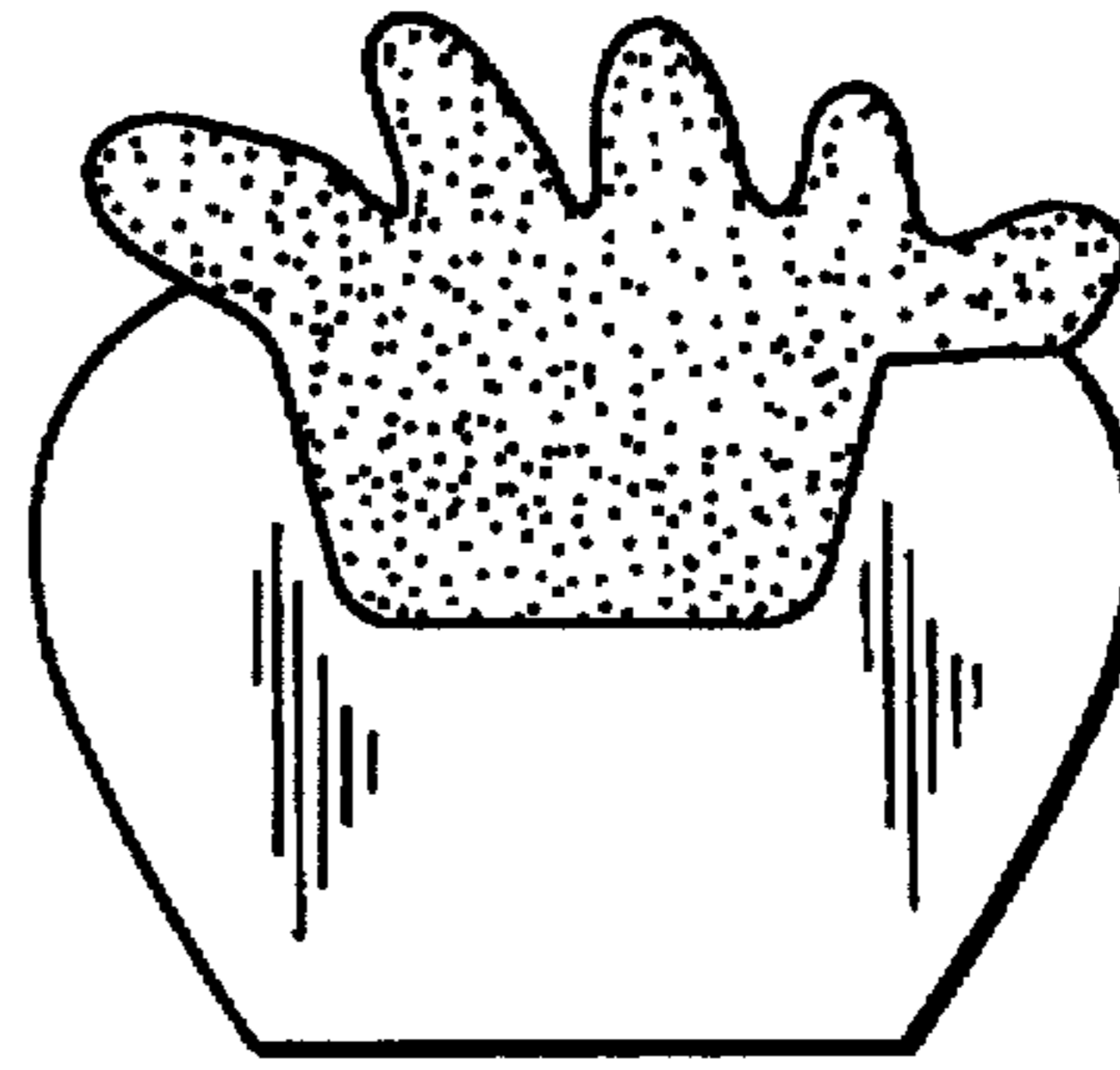

FIG. 6

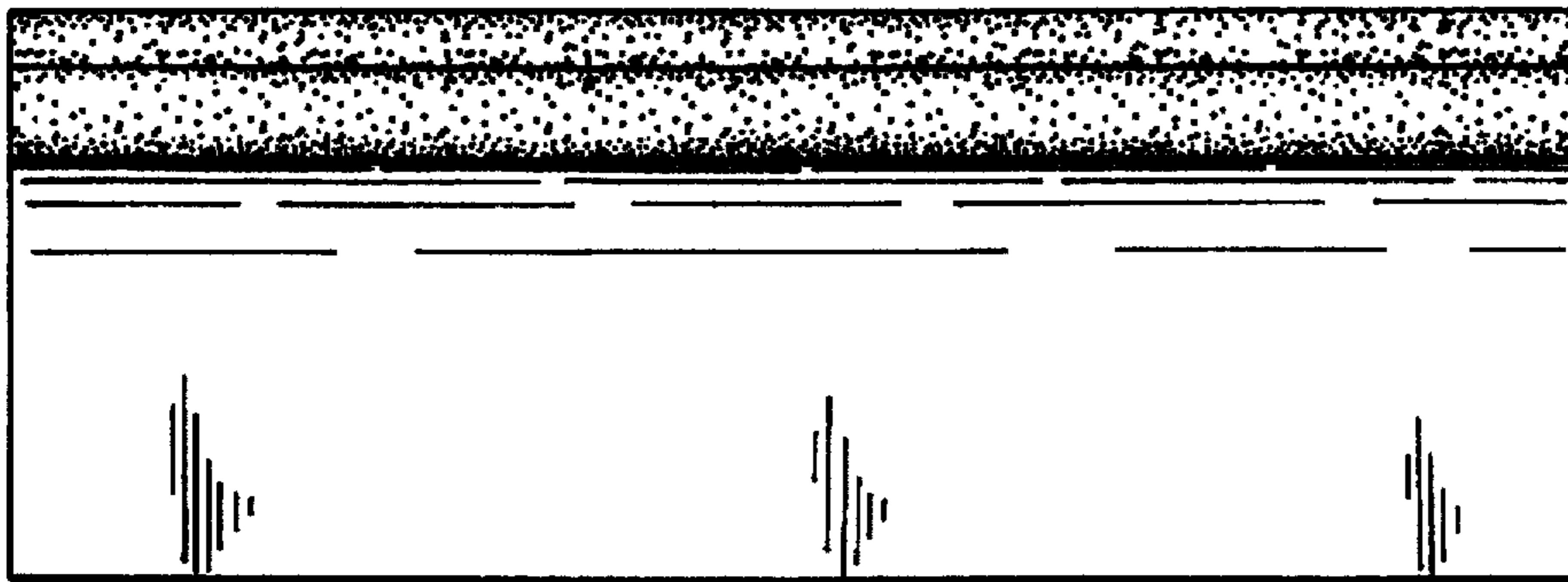

FIG. 7

