



US00D387085S

# United States Patent [19]

[11] Patent Number: **Des. 387,085**

Masujima et al.

[45] Date of Patent: **\*\*Dec. 2, 1997**

## [54] COMPUTER PRINTER

[75] Inventors: **Ikuo Masujima; Toshihiro Hayakawa,**  
both of Suwa, Japan

[73] Assignee: **Seiko Epson Corporation,** Tokyo,  
Japan

[\*\*] Term: **14 Years**

[21] Appl. No.: **49,349**

[22] Filed: **Jan. 23, 1996**

### [30] Foreign Application Priority Data

Jul. 24, 1995 [JP] Japan ..... 7-21411

[51] LOC (6) Cl. .... **18-02**

[52] U.S. Cl. .... **D18/54; D18/55**

[58] Field of Search ..... D18/50, 54, 55,  
D18/19; 400/691-694, 690.1-690.4, 613,  
613.1-613.4

### [56] References Cited

#### U.S. PATENT DOCUMENTS

|            |         |                      |         |
|------------|---------|----------------------|---------|
| D. 331,069 | 11/1992 | Hanasaki et al. .... | D18/55  |
| D. 339,373 | 9/1993  | Gassett et al. ....  | D18/50  |
| D. 343,192 | 1/1994  | Hirose ..... ..      | D18/55  |
| D. 356,818 | 3/1995  | Sekini et al. ....   | D18/55  |
| D. 373,596 | 9/1996  | Sekine et al. ....   | D18/55  |
| D. 376,814 | 12/1996 | Asai et al. ....     | D18/50  |
| 4,663,637  | 5/1987  | Saitou ..... ..      | D18/55  |
| 5,387,043  | 2/1995  | Fujioka et al. ....  | 400/691 |

## FOREIGN PATENT DOCUMENTS

|         |         |               |        |
|---------|---------|---------------|--------|
| 8800088 | 10/1988 | Germany ..... | D18/54 |
| 616759  | 3/1963  | Japan .....   | D18/55 |
| 5541495 | 2/1986  | Japan .....   | D18/50 |

## OTHER PUBLICATIONS

Japanese Publication of Canon Corp. "Laser Shot" Printer Catalog pg.; Oct. 1991.

Data Products Brochure; 8500 Printer; front cover; bottom right corner; Apr. 1993.

Primary Examiner—Cathy Anne MacCormac

Attorney, Agent, or Firm—Stroock & Stroock & Lavan LLP

## [57] CLAIM

The ornamental design for a computer printer, as shown and described.

## DESCRIPTION

FIG. 1 is a front perspective view of a computer printer showing our new design;  
 FIG. 2 is a front view thereof;  
 FIG. 3 is a right side view thereof;  
 FIG. 4 is a left side view thereof;  
 FIG. 5 is a top plan view thereof;  
 FIG. 6 is a bottom view thereof;  
 FIG. 7 is a rear view thereof; and,  
 FIG. 8 is another perspective view thereof.

**1 Claim, 4 Drawing Sheets**

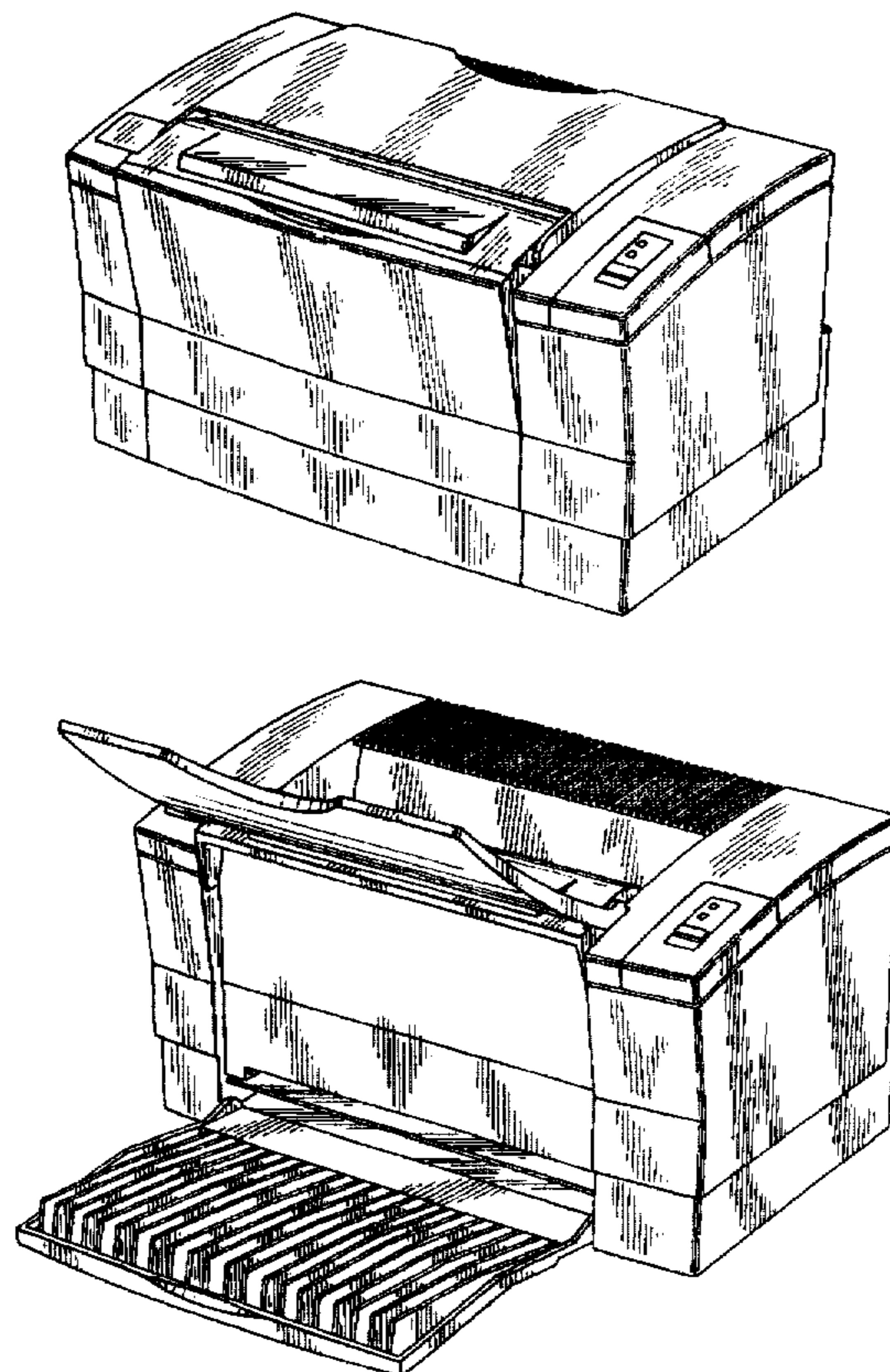

FIG. 1

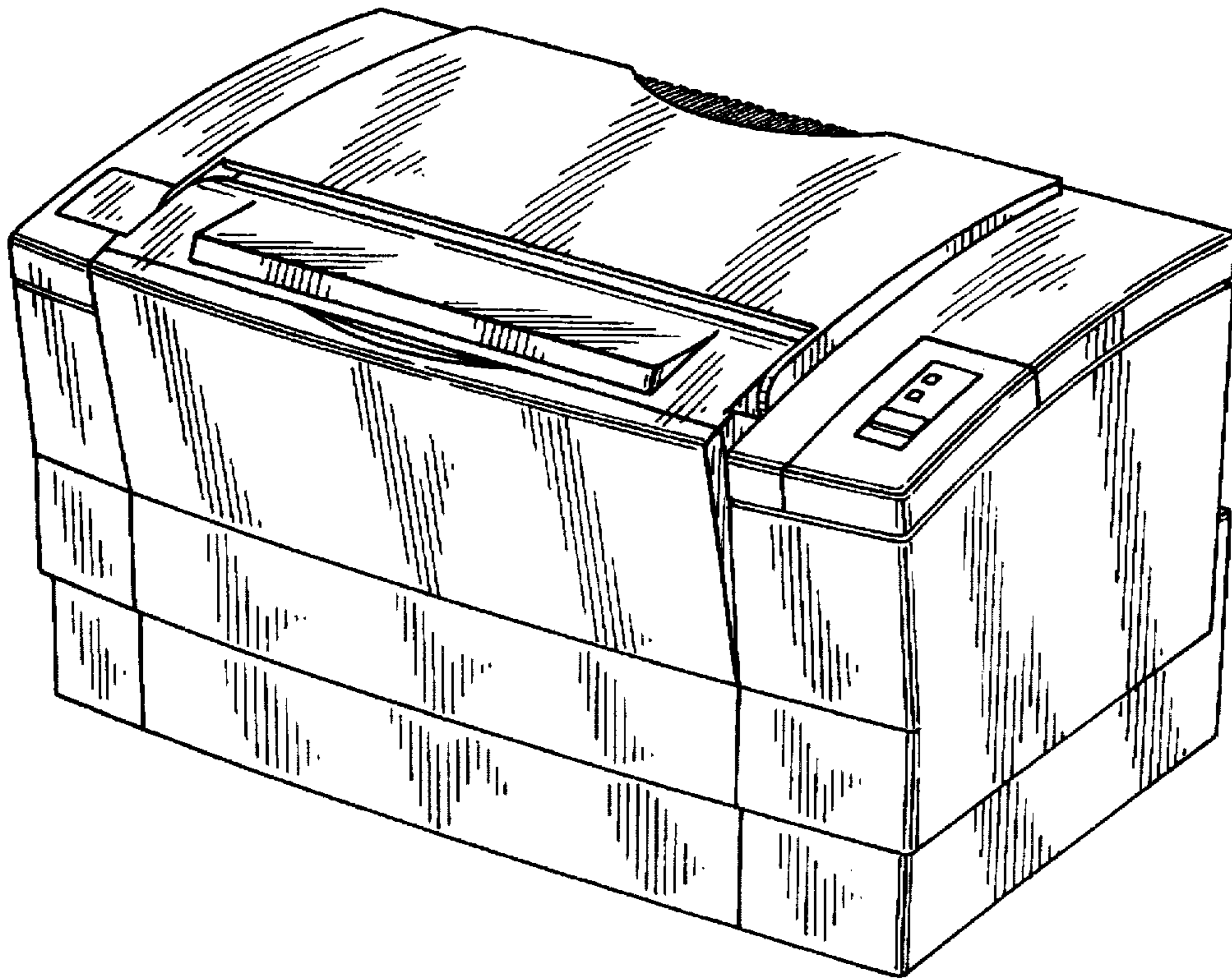

FIG. 2

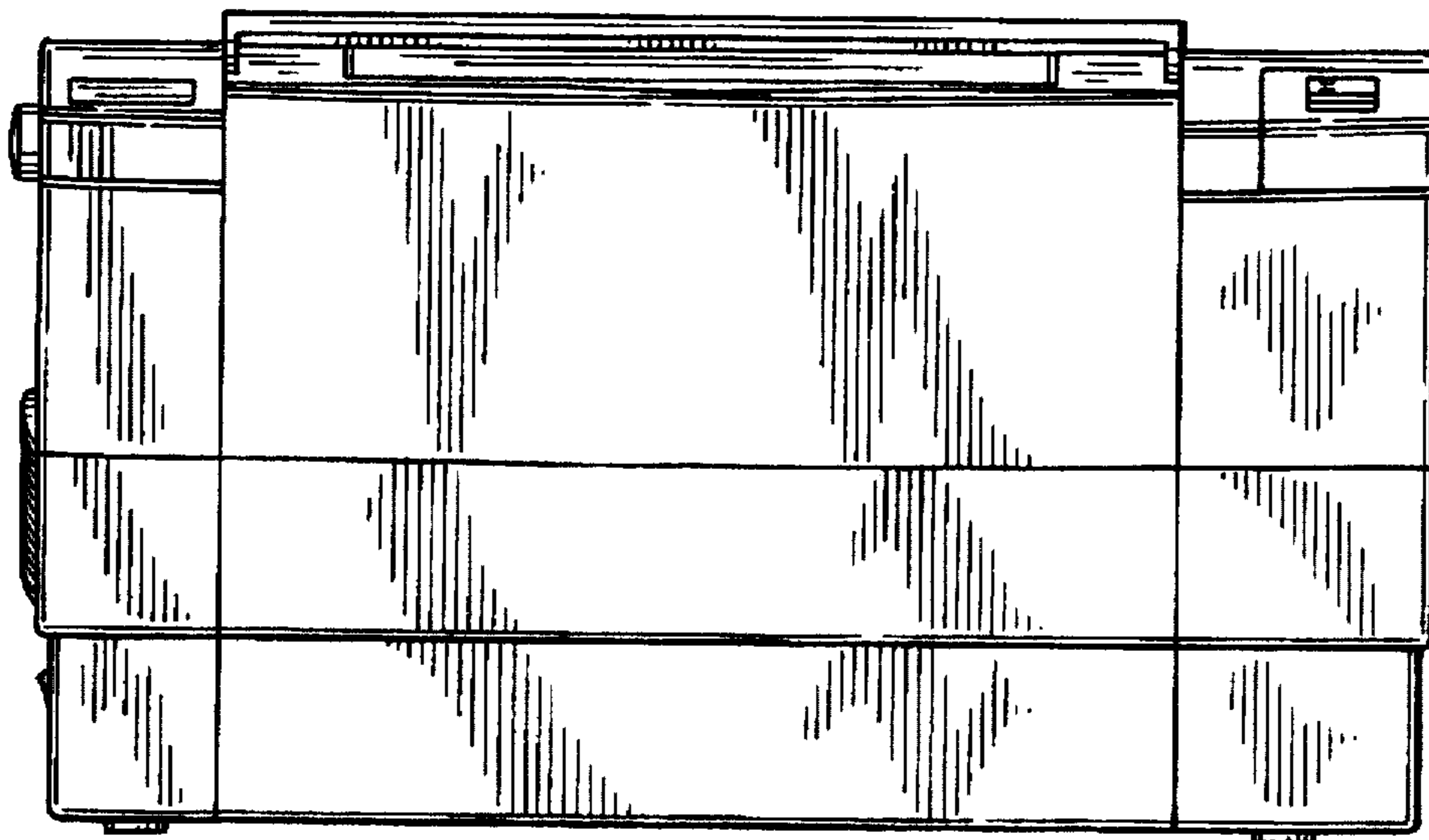

FIG. 3

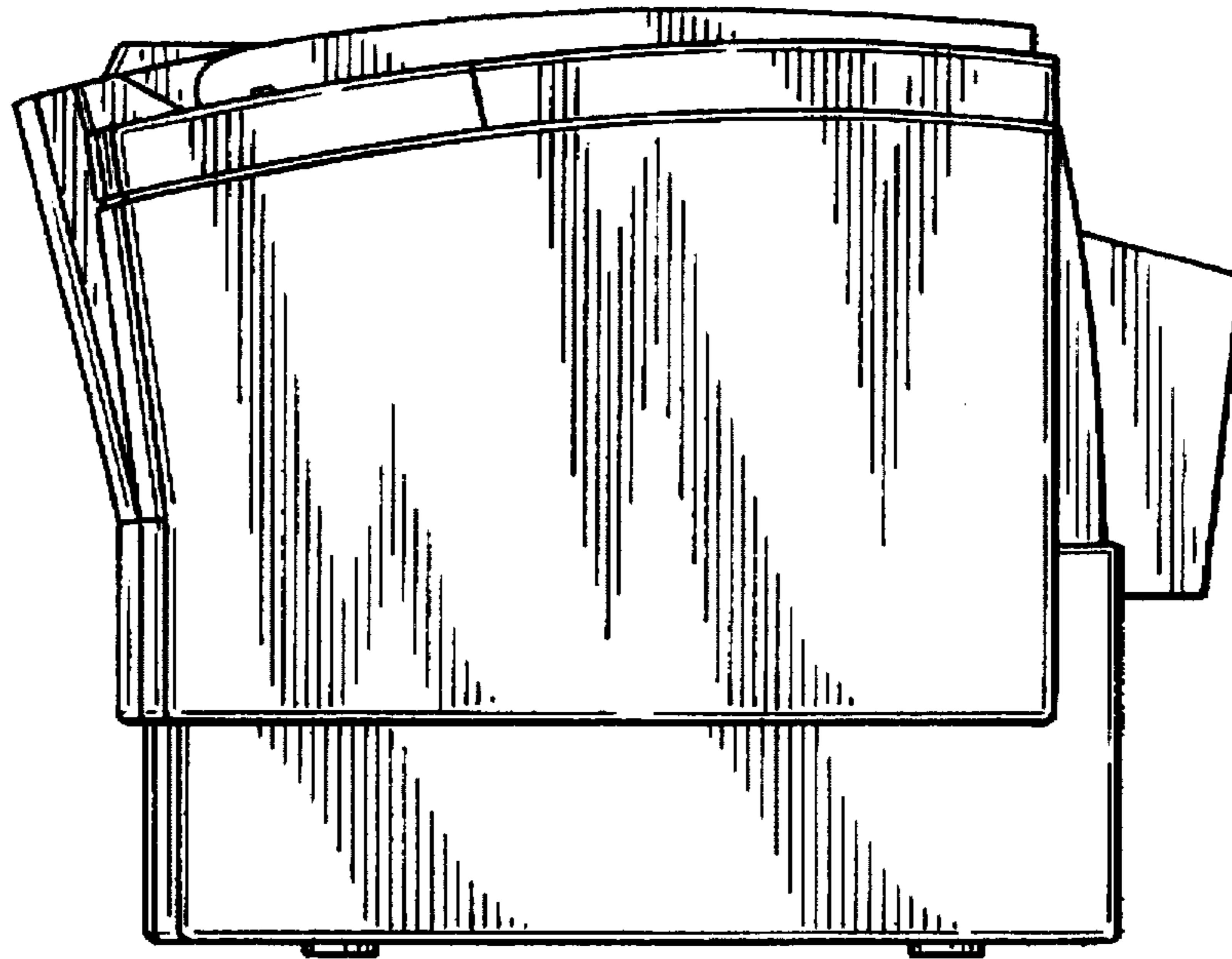

FIG. 4

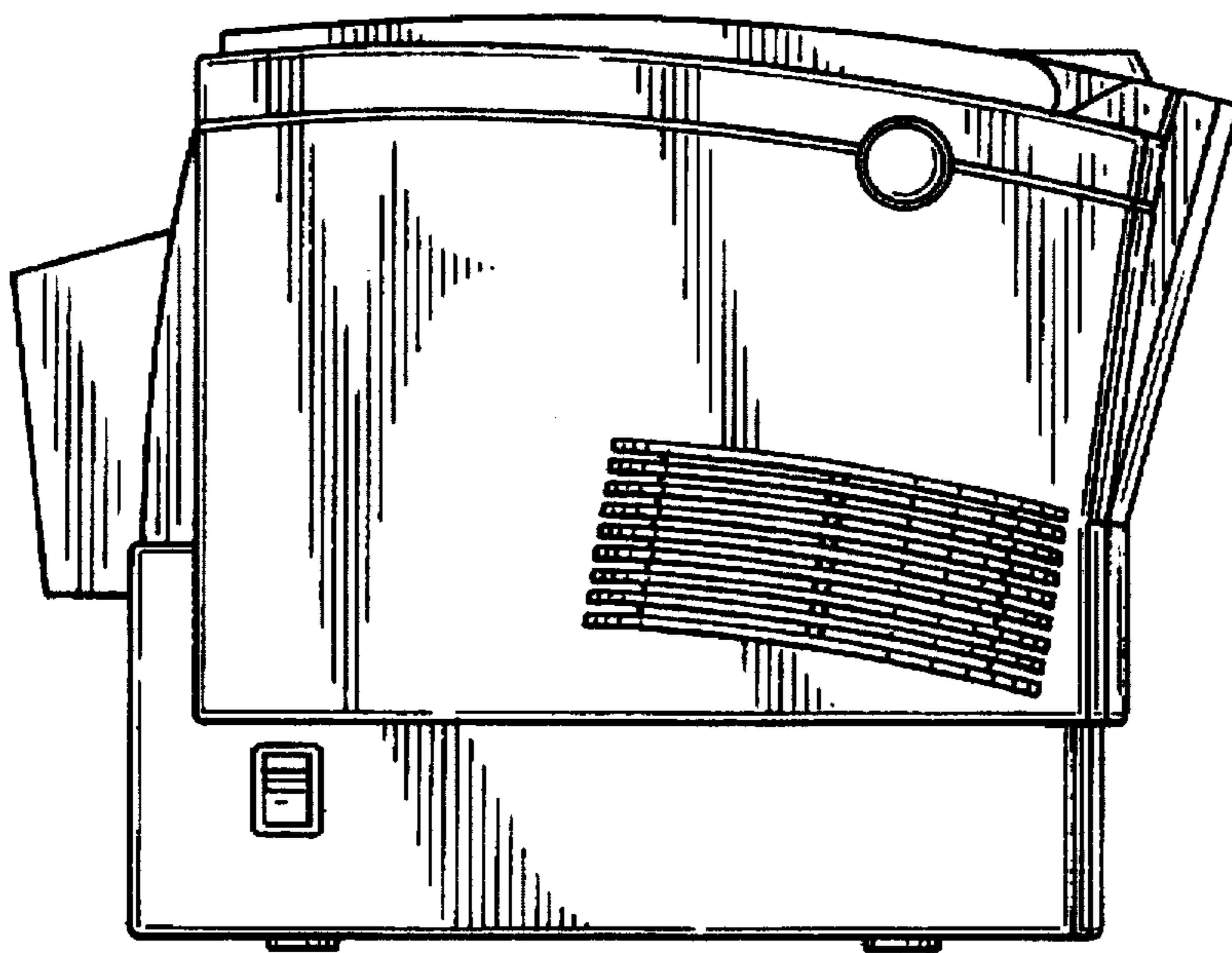

FIG. 5

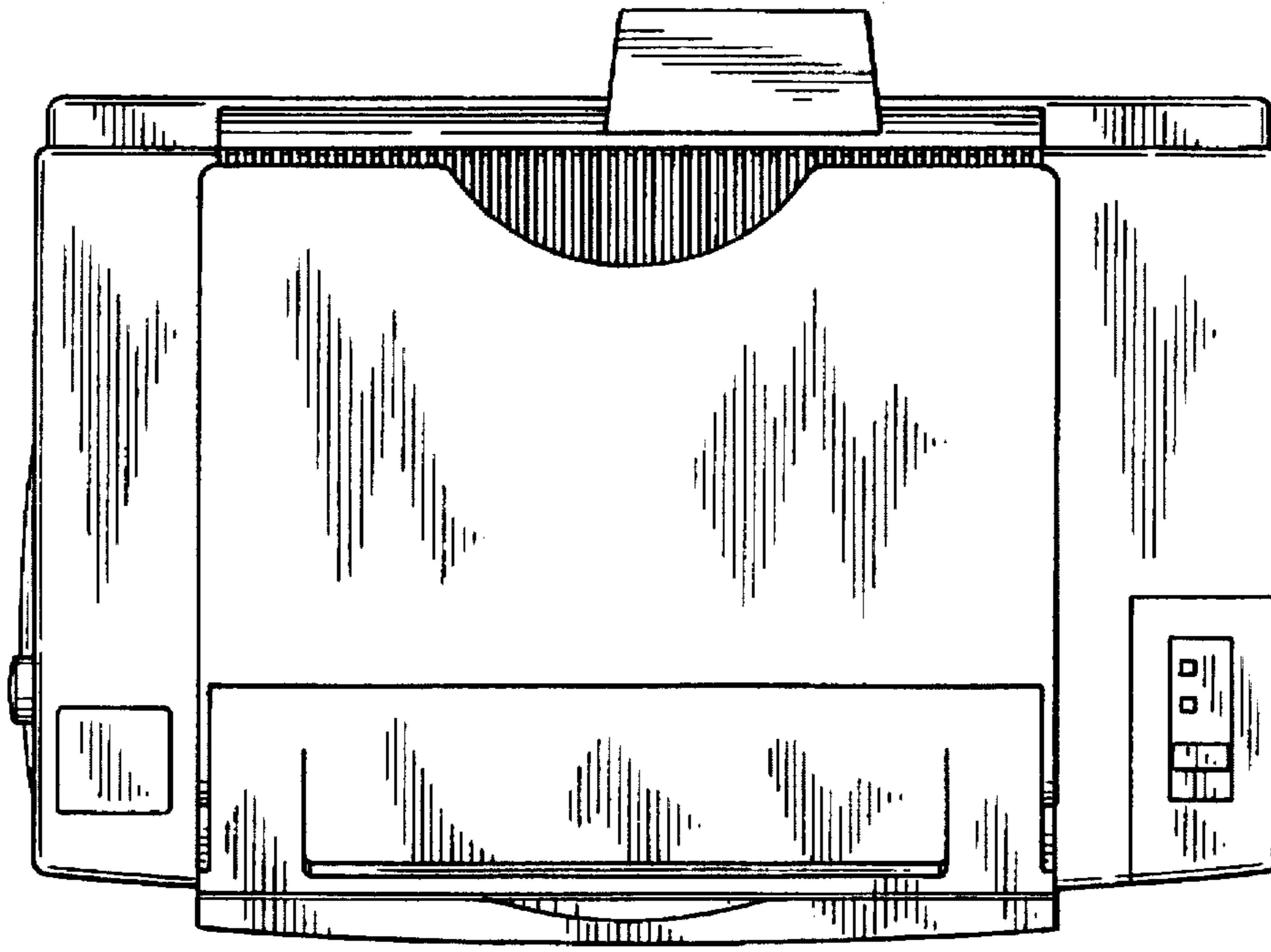

FIG. 6

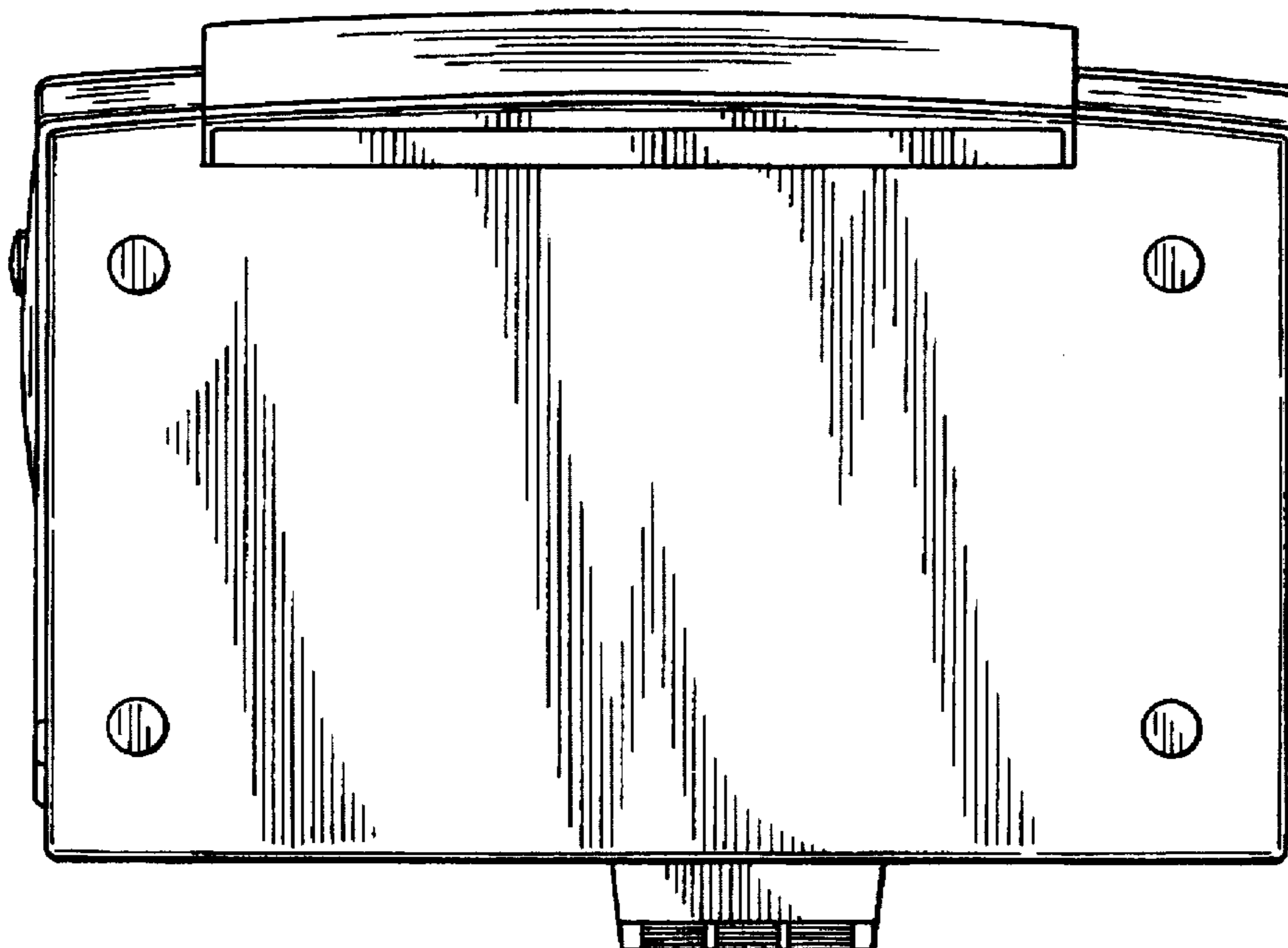

FIG. 7

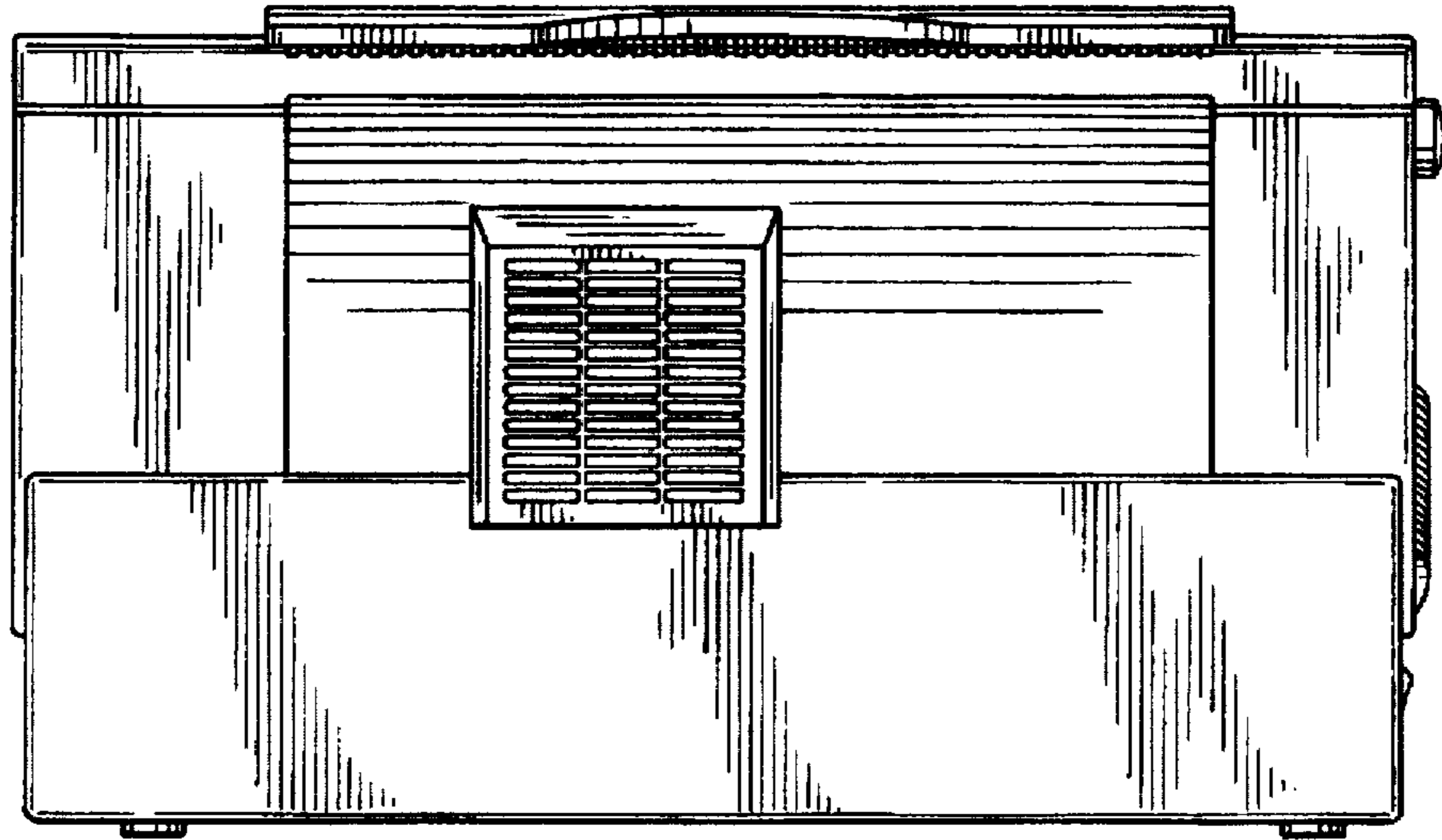

FIG. 8

