



US00D387067S

United States Patent [19] Gaffney

[11] Patent Number: Des. 387,067

[45] Date of Patent: **Dec. 2, 1997

[54] **AQUARIUM PUMP**

[75] Inventor: **Edward F. Gaffney**, Oakland, N.J.

[73] Assignee: **Renaissance International, Inc.**,
Pompton Plains, N.J.

[**] Term: **14 Years**

[21] Appl. No.: **60,441**

[22] Filed: **Sep. 27, 1996**

[51] LOC (6) Cl. **15-02**

[52] U.S. Cl. **D15/8**

[58] Field of Search **D15/7-8; 210/416.2,
210/169**

[56] **References Cited**

U.S. PATENT DOCUMENTS

D. 215,765	10/1969	Levin	D15/8
D. 217,886	6/1970	Itakura	D15/8
D. 247,435	3/1978	Willinger et al.	D15/8
D. 247,436	3/1978	Willinger et al.	D15/8
D. 353,652	12/1994	Maryanski	D15/8
367,151	6/1887	Duke et al.	D15/8
4,620,924	11/1986	Goldman et al.	210/416.2

OTHER PUBLICATIONS

- Advertisement, Elite-Maxima-Optima, No Date.
- Advertisement, Force 1 & 2, No Date.
- Advertisement, The Heart of Your Show case, No date.
- Advertisement, "The Pump", No Date p. 39.
- Advertisement, Silent Air Aquarium Pumps, Penn-Plax, Inc., No Date p. A24.
- Advertisement, Undergravel Filters, Perfecto Manufacturing, No Date p. A25.

Advertisement, Twelve Models Are Available Through All Leading Pet Shop Distributors, Tetra/Second Nature, No Date.

Primary Examiner—Ralf Seifert
Attorney, Agent, or Firm—William H. Murray; Robert E. Rosenthal

[57] **CLAIM**

The ornamental design for an aquarium pump, as shown and described.

DESCRIPTION

FIG. 1 is a perspective view of an aquarium pump showing my new design;
 FIG. 2 is a top plan view thereof;
 FIG. 3 is a bottom plan view thereof;
 FIG. 4 is a front elevational view thereof;
 FIG. 5 is a left side elevational view thereof;
 FIG. 6 is a right side elevational view thereof;
 FIG. 7 is a perspective view of an aquarium pump showing a second embodiment of my new design;
 FIG. 8 is a top plan view of FIG. 7;
 FIG. 9 is a bottom plan view of FIG. 7;
 FIG. 10 is a front elevational view of FIG. 7, the rear elevational view being a mirror image;
 FIG. 11 is a right side elevational view of FIG. 7;
 FIG. 12 is a left side elevational view of FIG. 7; and,
 FIG. 13 is a partial cross section taken along line 13—13 of FIG. 1, a similar cross section of the second recess shown in FIG. 1 being identical thereto.

The broken line showing of a power cord is for illustrative purposes only and forms no part of the claimed design.

1 Claim, 9 Drawing Sheets

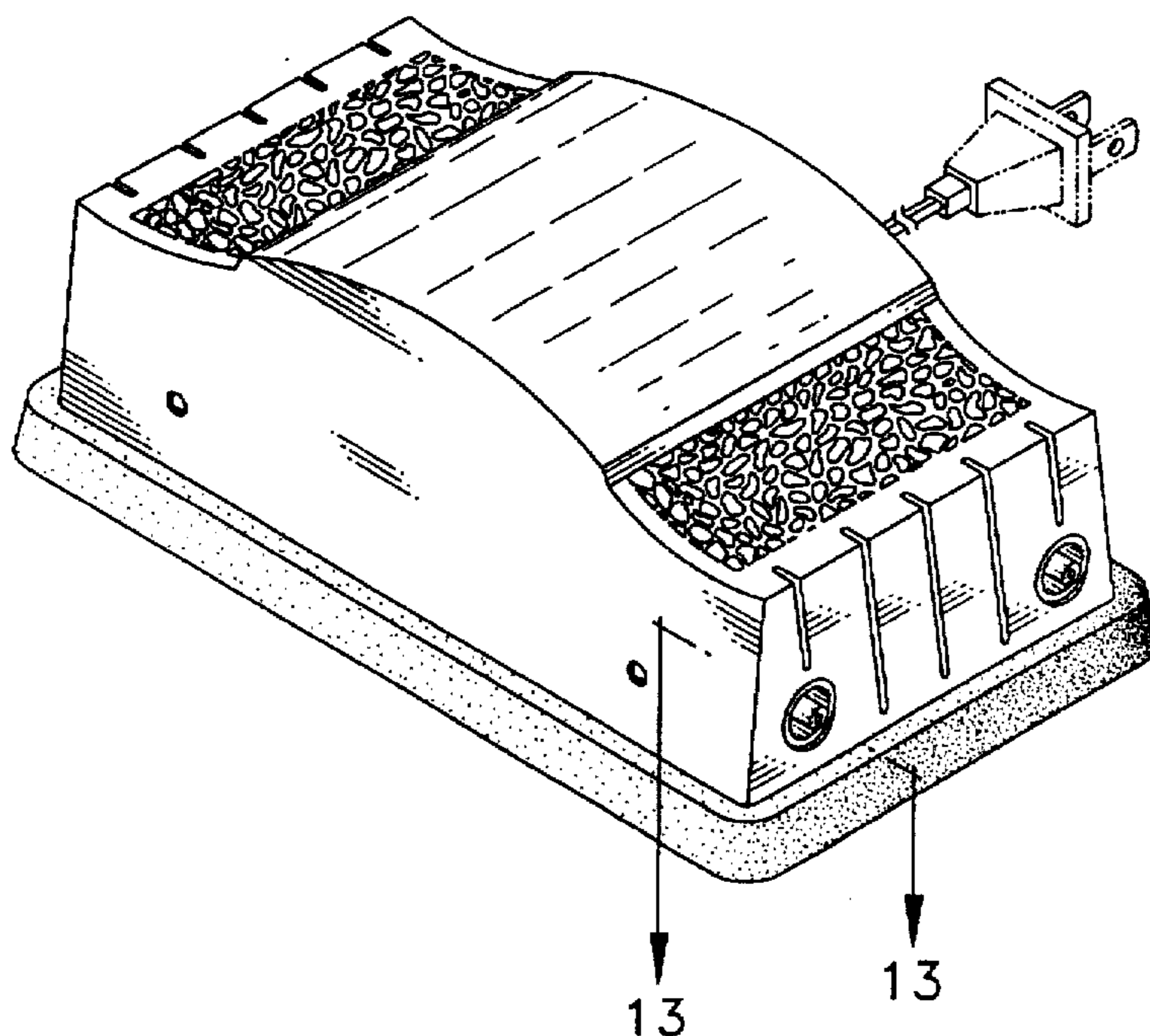

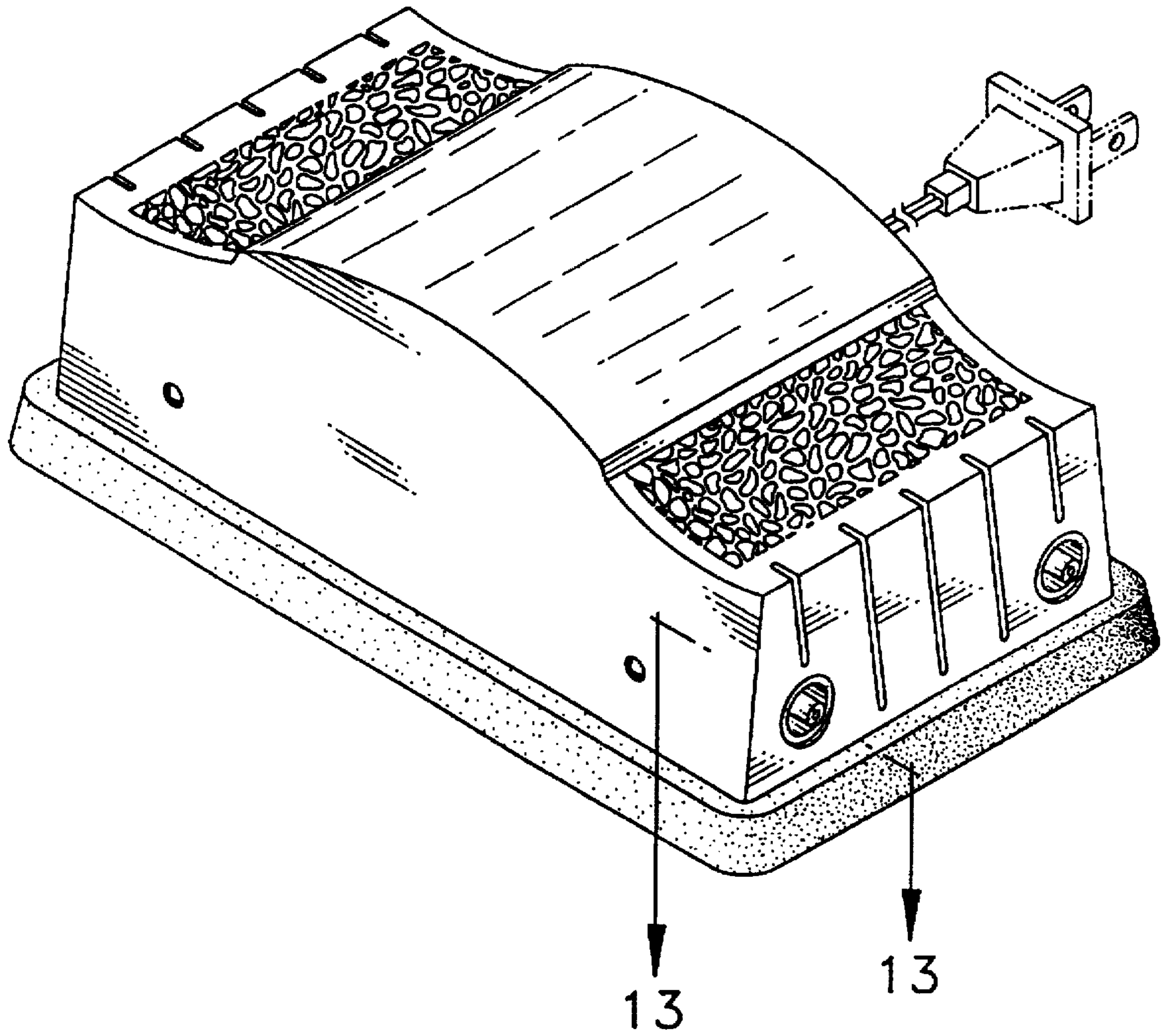

FIG. 1

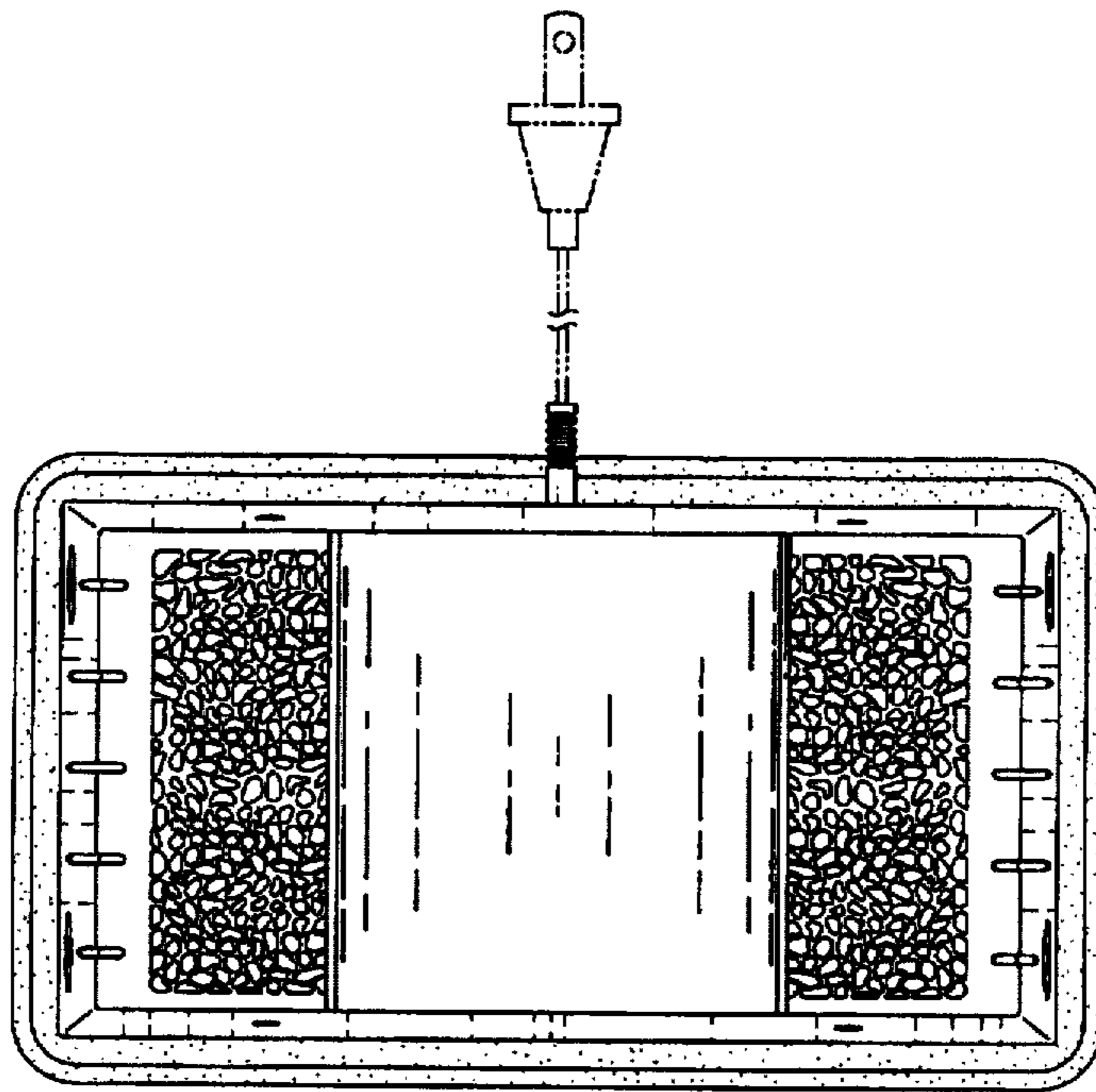

FIG. 2

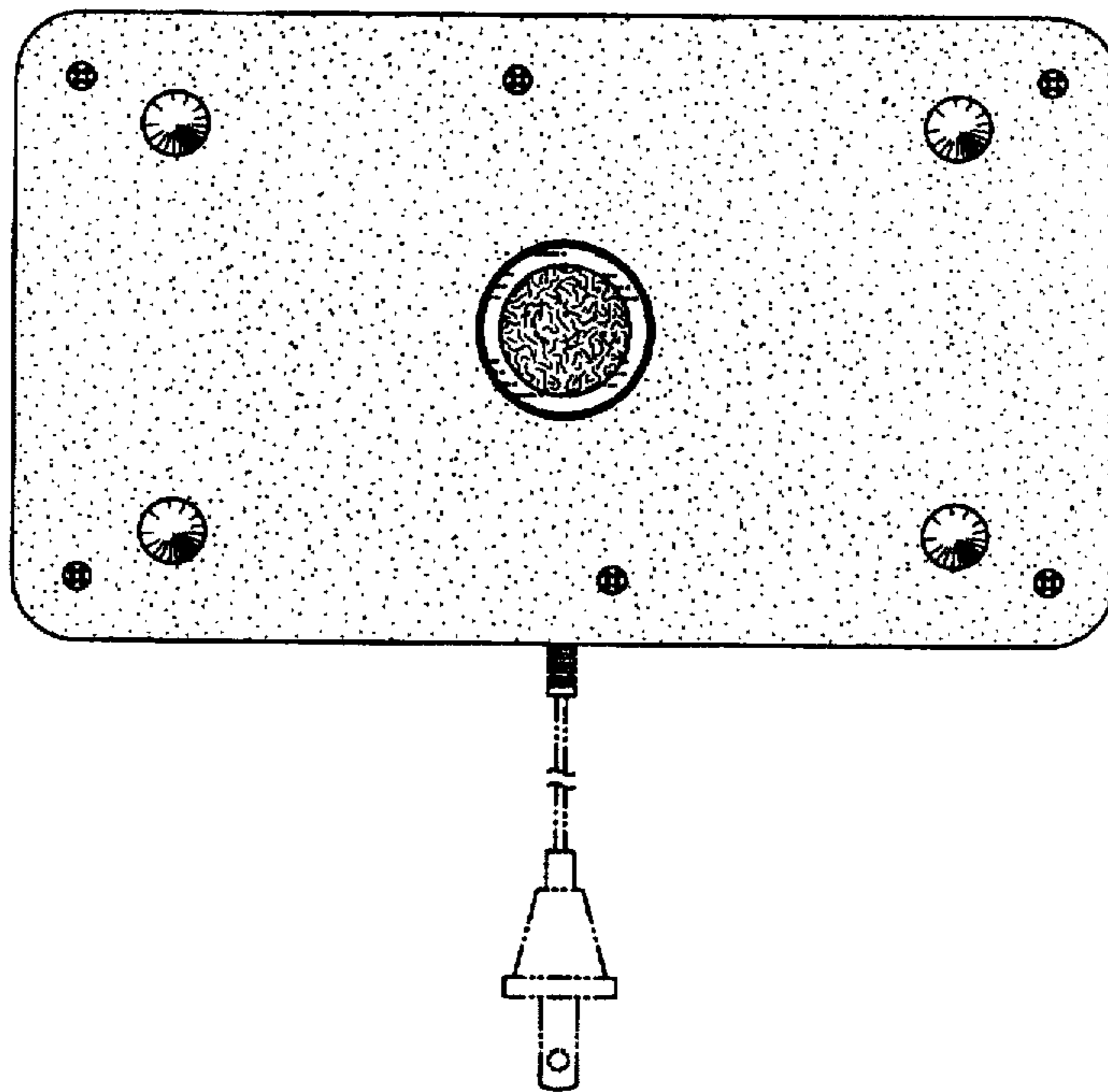

FIG. 3

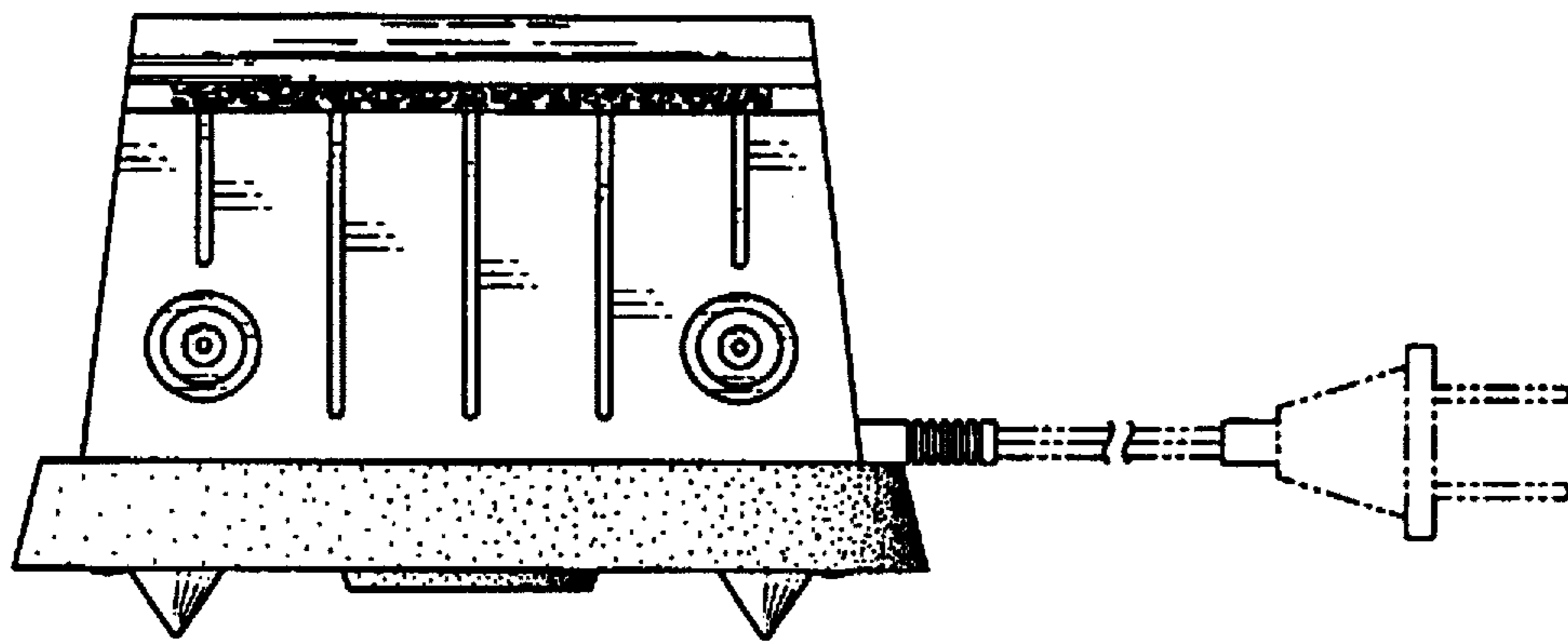

FIG. 4

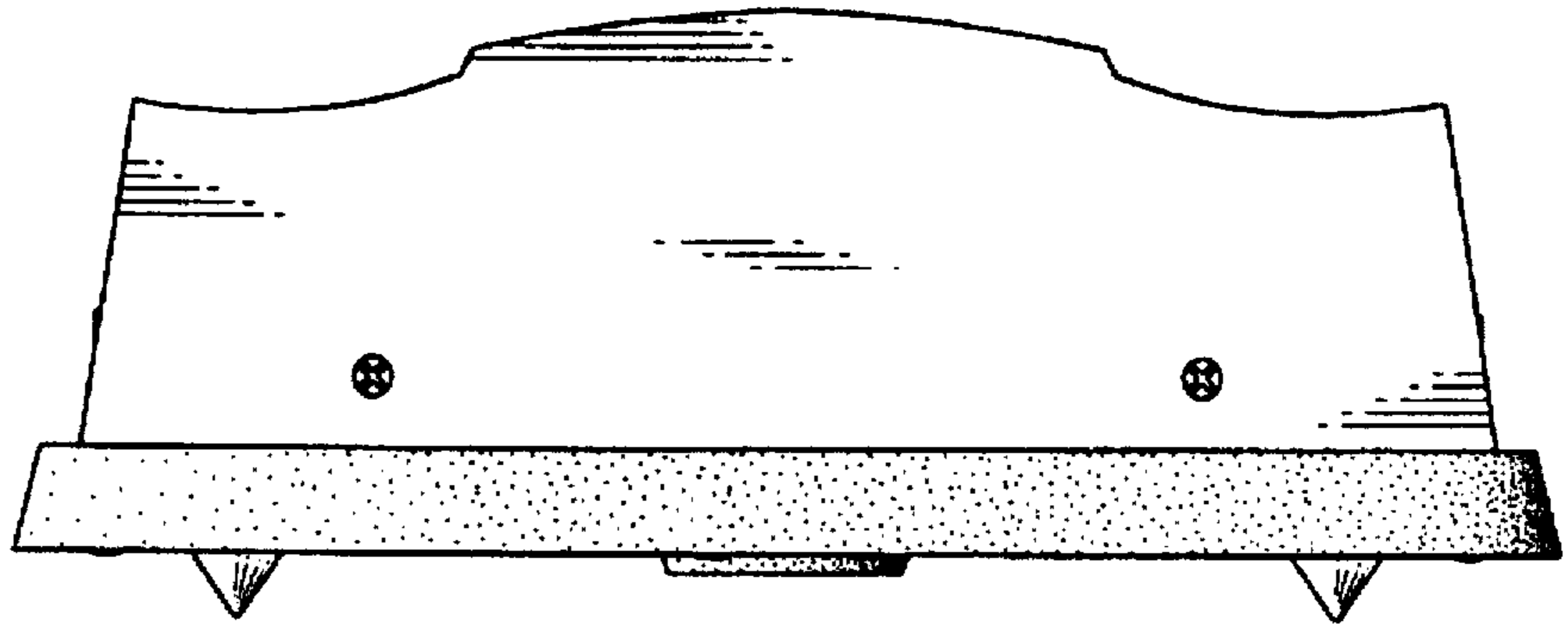

FIG. 5

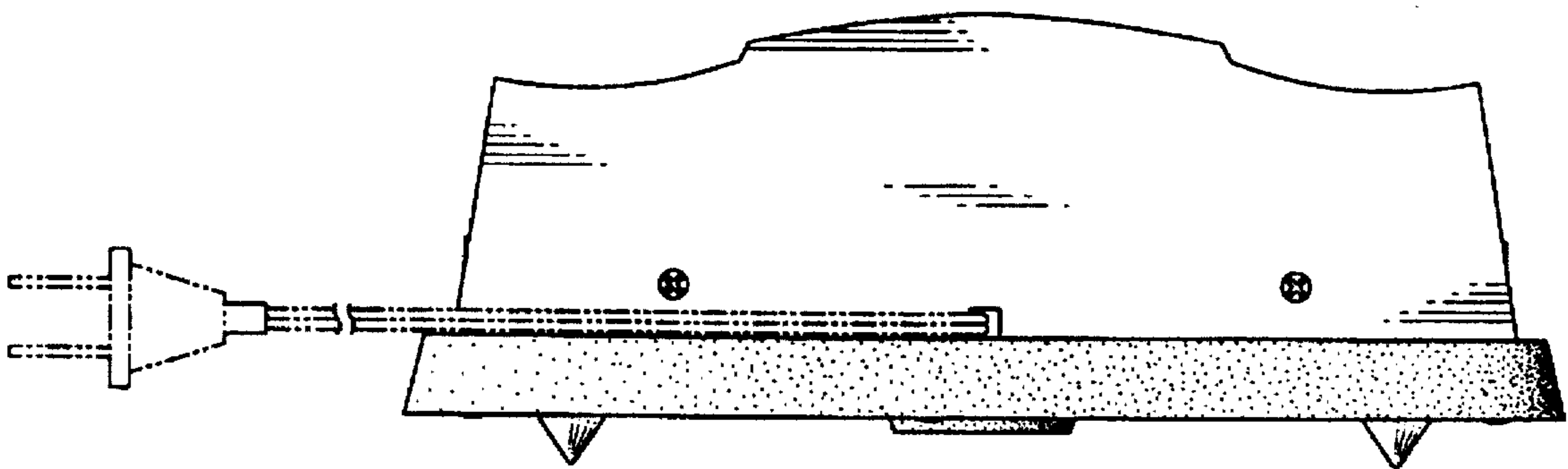

FIG. 6

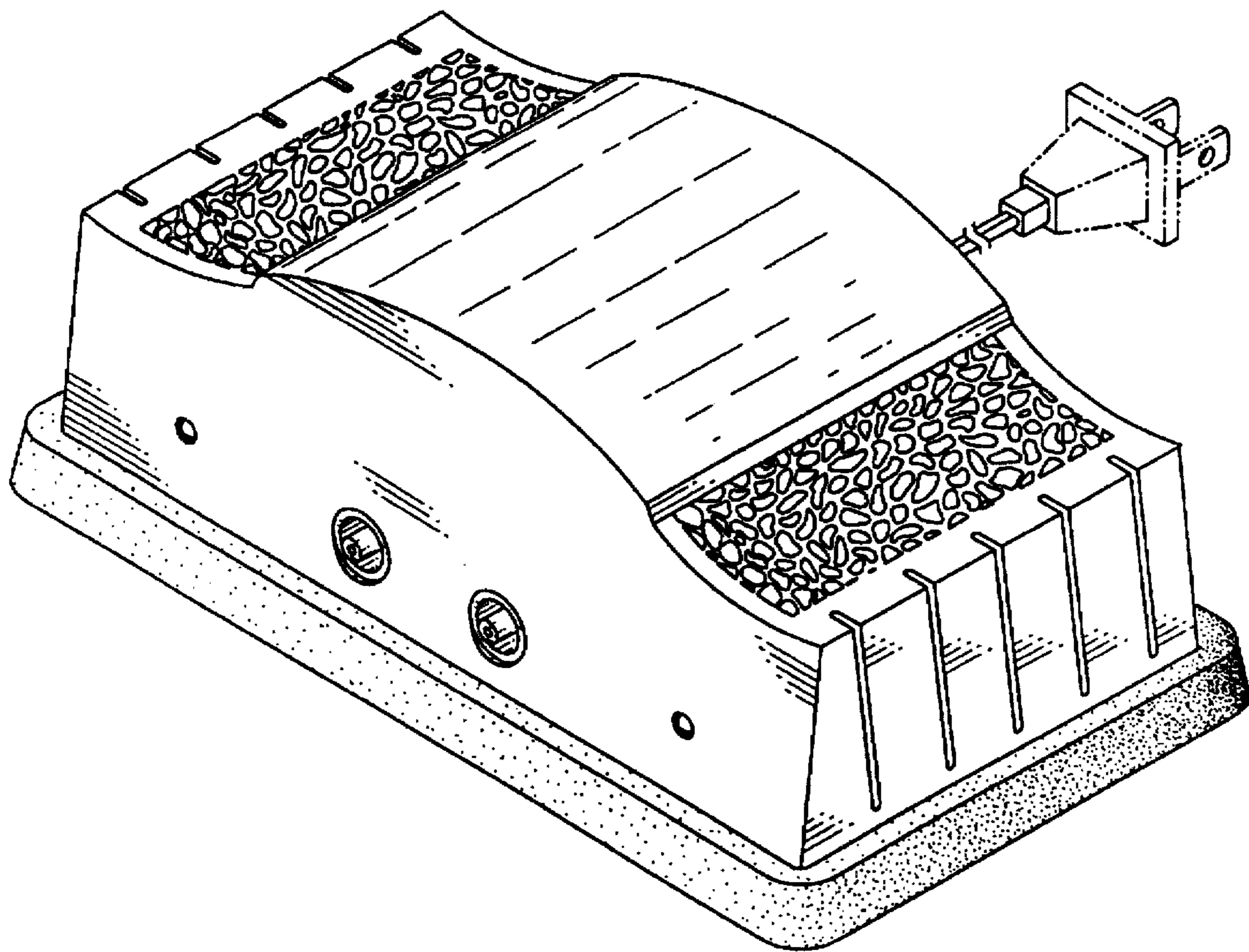

FIG. 7

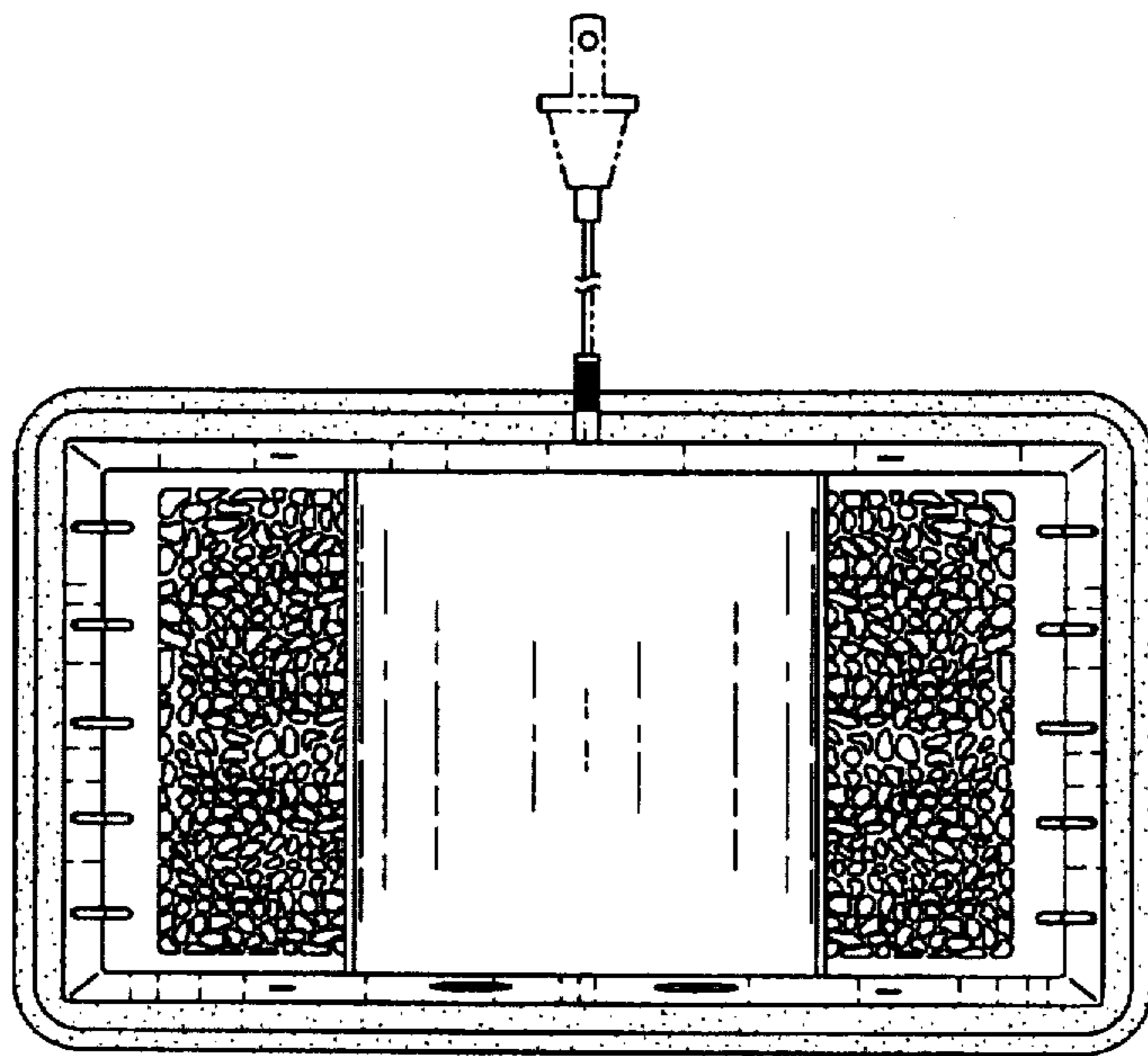

FIG. 8

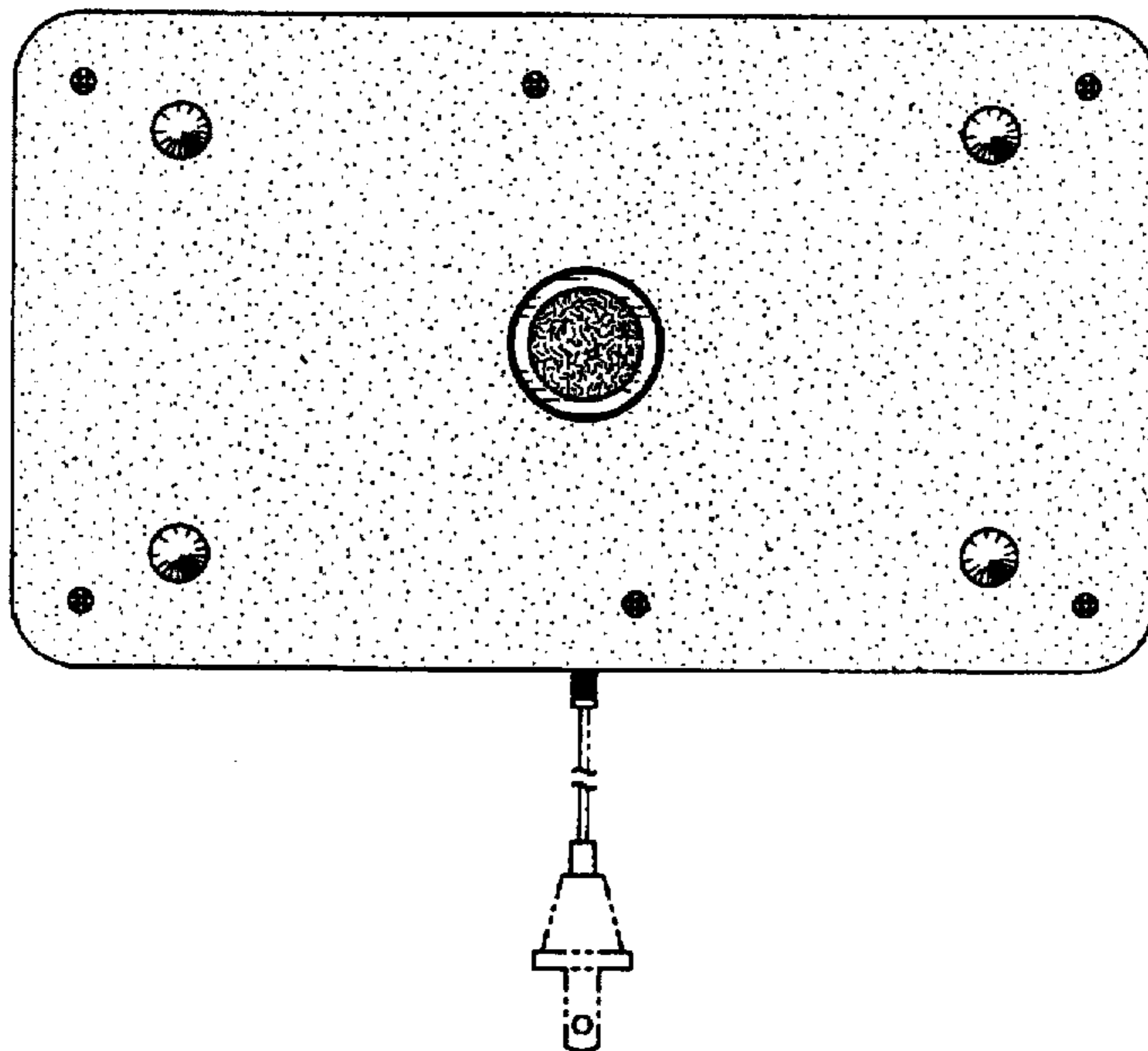

FIG. 9

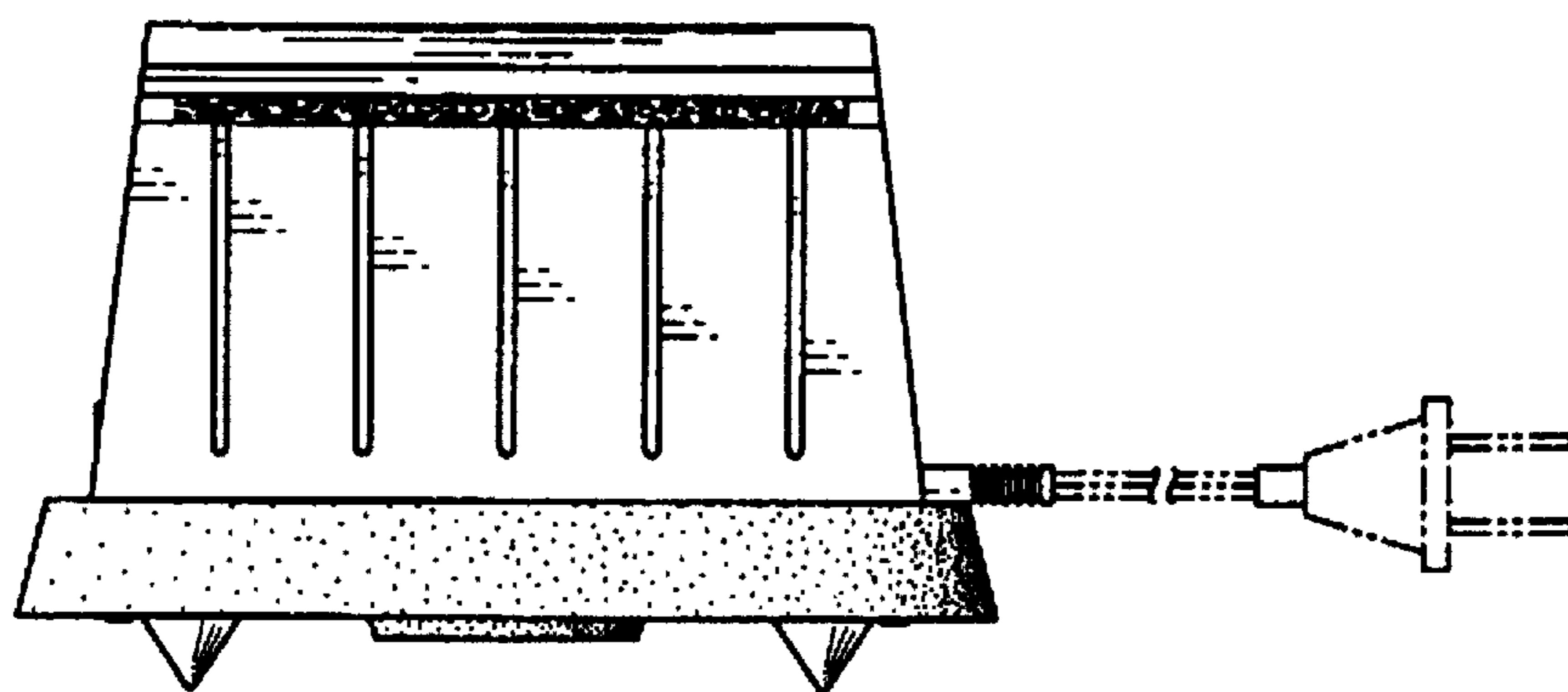

FIG. 10

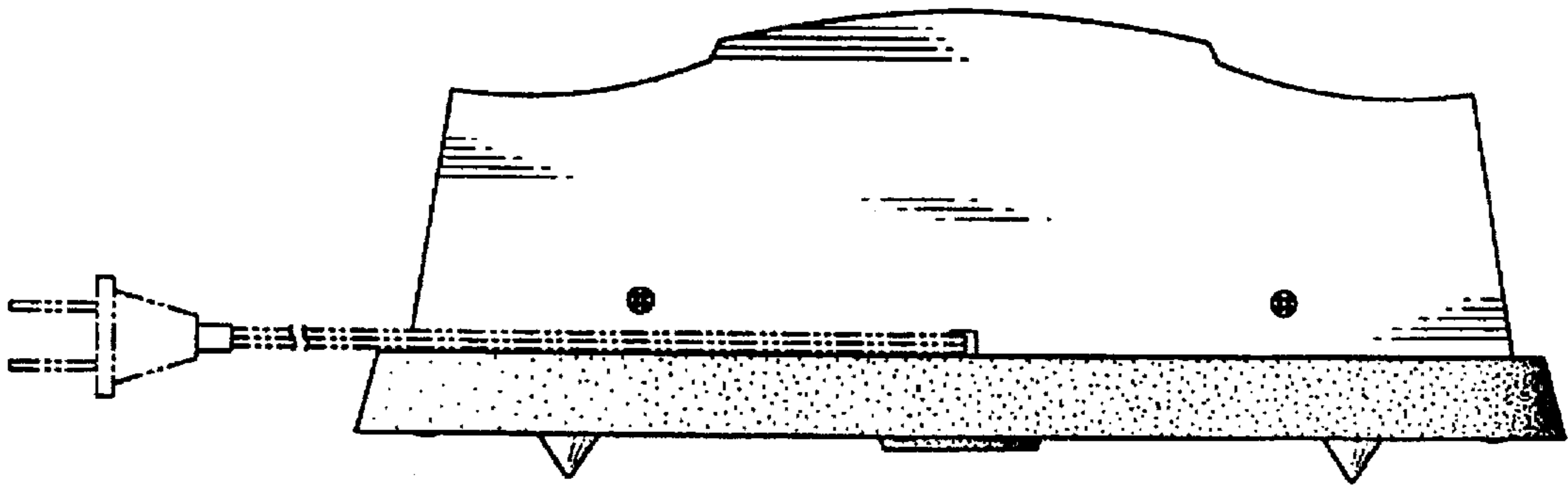

FIG. 11

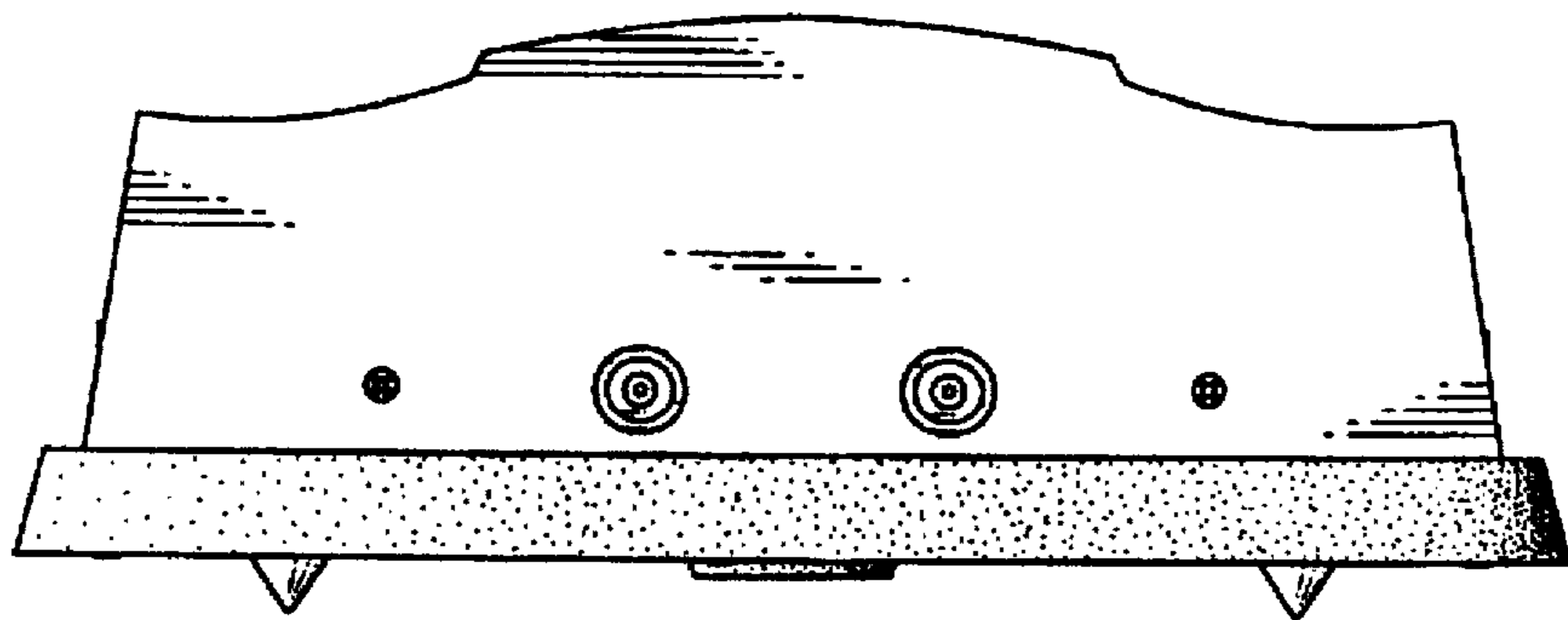

FIG. 12

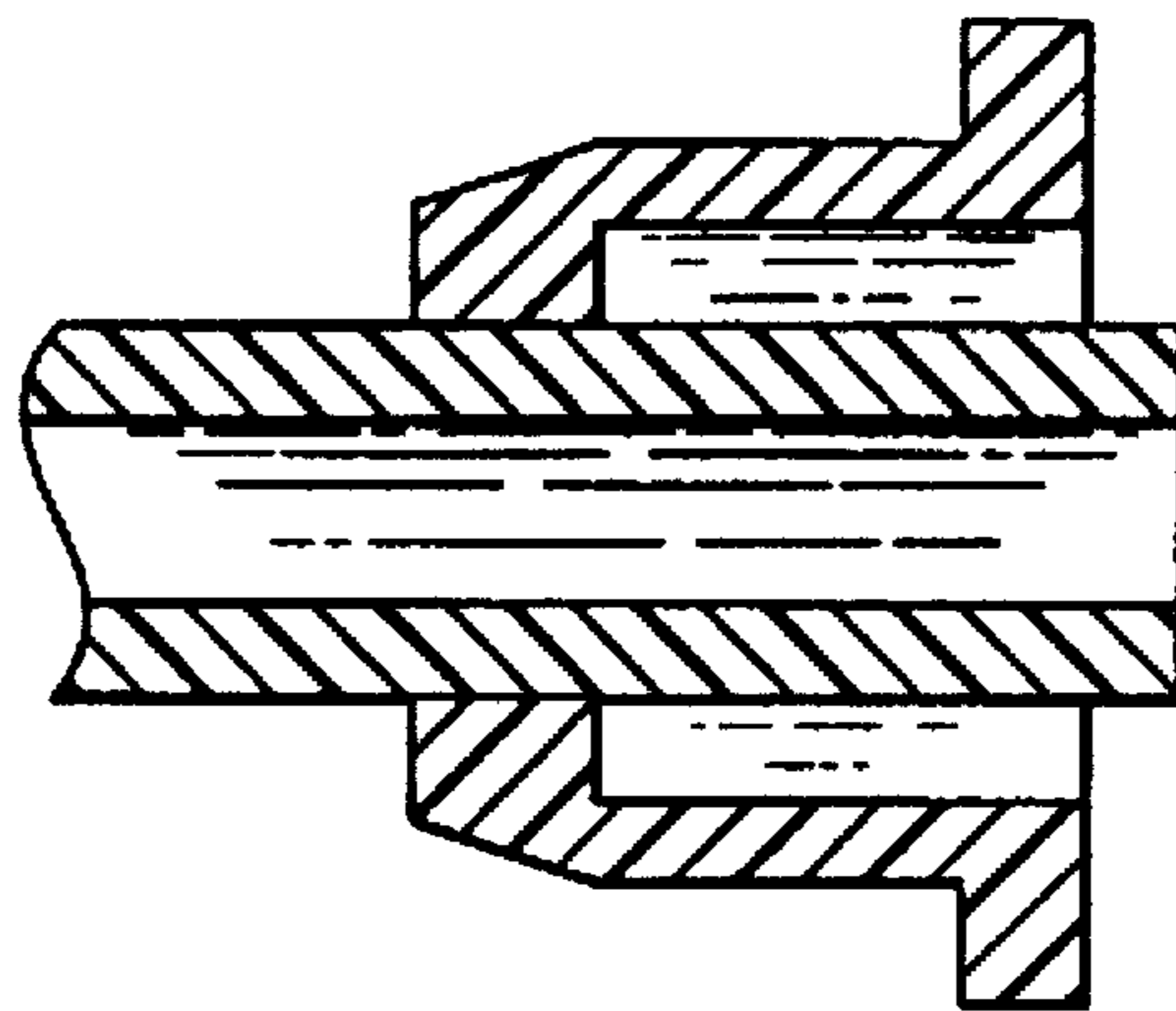

FIG. 13