

US00D386746S

United States Patent [19]

[11] Patent Number: **Des. 386,746**

Su

[45] Date of Patent: ****Nov. 25, 1997**

[54] **PULSE MODULATED MID-FREQUENCY CURRENT GENERATOR**

D. 377,338 1/1997 Terleski D13/184
4,884,034 11/1989 Guzman 340/650 X

[76] Inventor: **Shou-Mei Su**, 1 3rd Floor, No. 193, Sec. 1, Tun-Hwa, South Road, Taipei, Taiwan

Primary Examiner—James Gandy
Assistant Examiner—Cathron B. Matta
Attorney, Agent, or Firm—Morton J. Rosenberg; David I. Klein

[**] Term: **14 Years**

[57] **CLAIM**

[21] Appl. No.: **58,353**

The ornamental design for a pulse modulated mid-frequency current generator, as shown and described.

[22] Filed: **Aug. 12, 1996**

DESCRIPTION

[51] LOC (6) Cl. **13-03**

[52] U.S. Cl. **D13/123; D13/184**

[58] Field of Search D13/112, 110, D13/123, 162, 184; D14/217; 340/539, 573, 825.22, 825.54, 825.69, 825.72

FIG. 1 is a top, front and right side perspective view of a pulse modulated mid-frequency current generator showing my new design;

FIG. 2 is a front elevational view thereof;

FIG. 3 is a rear elevational view thereof;

FIG. 4 is a top plan view thereof;

FIG. 5 is a bottom plan view thereof;

FIG. 6 is a left side elevational view thereof; and,

FIG. 7 is a right side elevational view thereof.

[56] **References Cited**

U.S. PATENT DOCUMENTS

D. 301,869 6/1989 Schwartz D13/162
D. 328,591 8/1992 Yokoi et al. D13/184 X
D. 340,916 11/1993 Iimura D13/162 X
D. 376,785 12/1996 Ikeda et al. D13/110

1 Claim, 5 Drawing Sheets

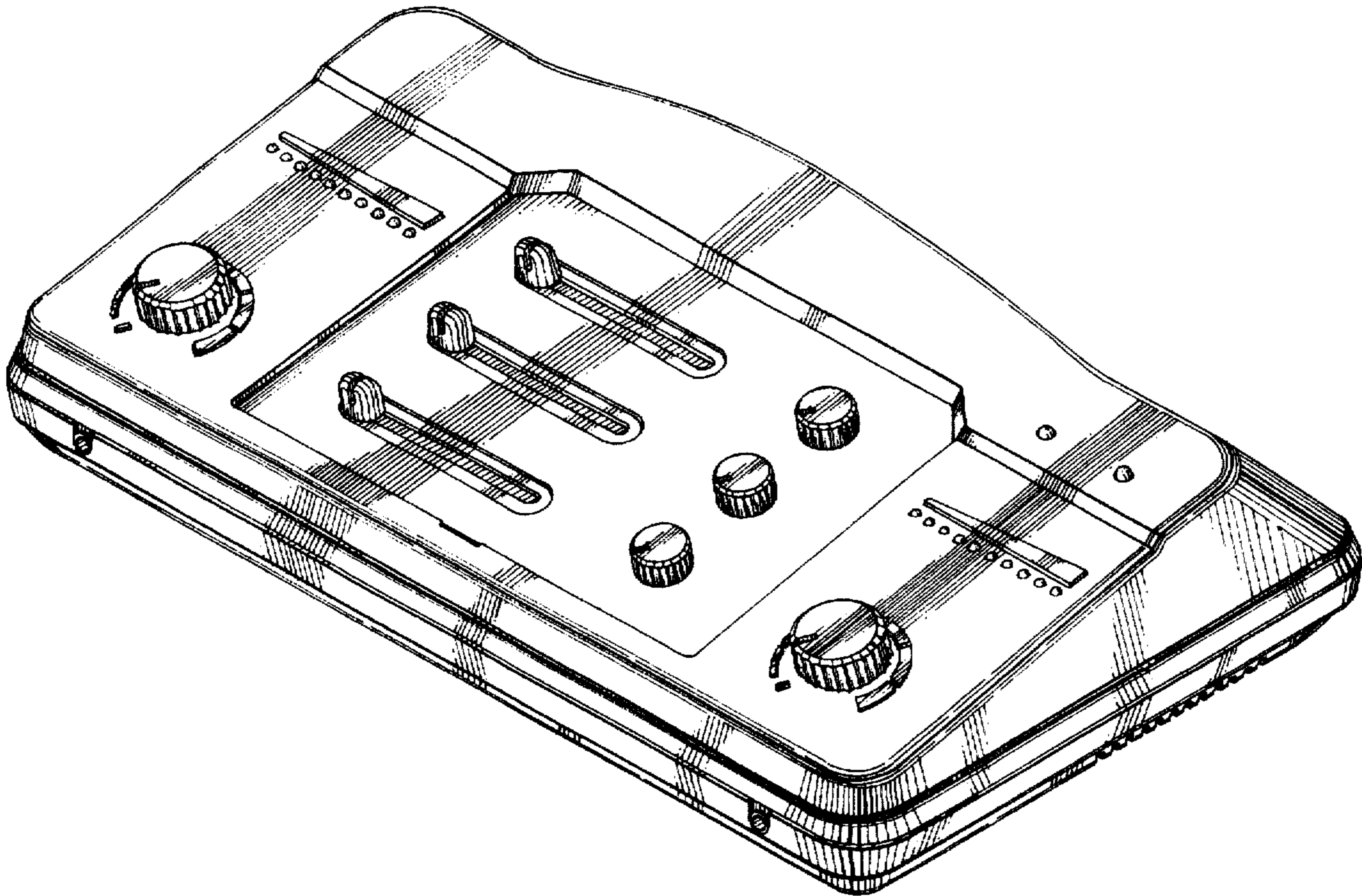

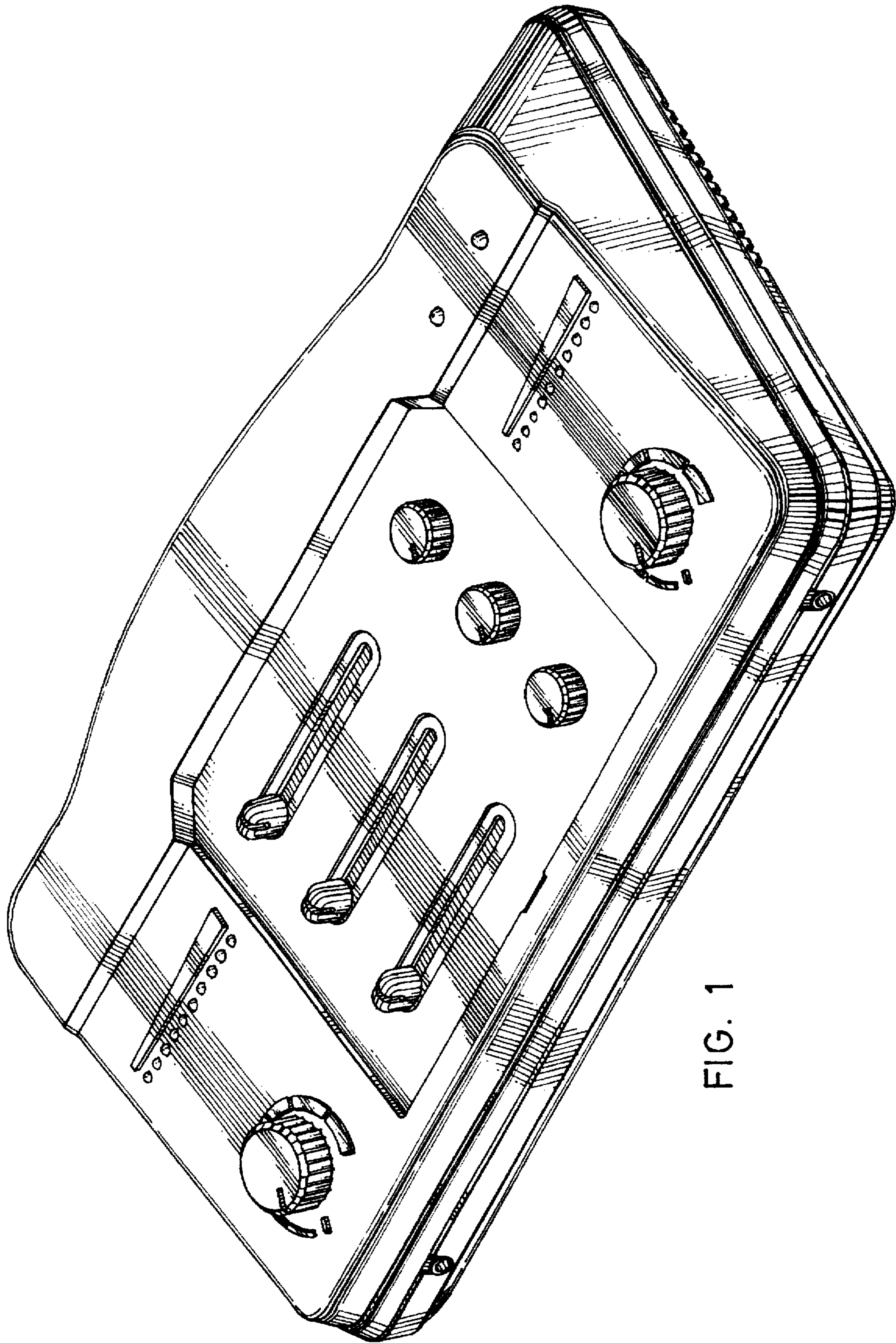

FIG. 1

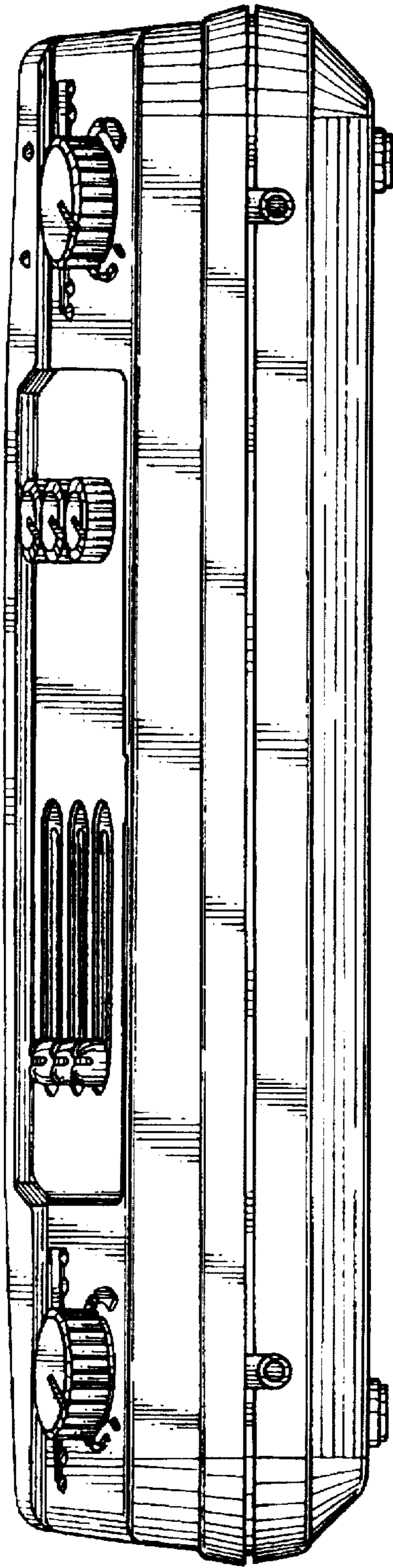

FIG. 2

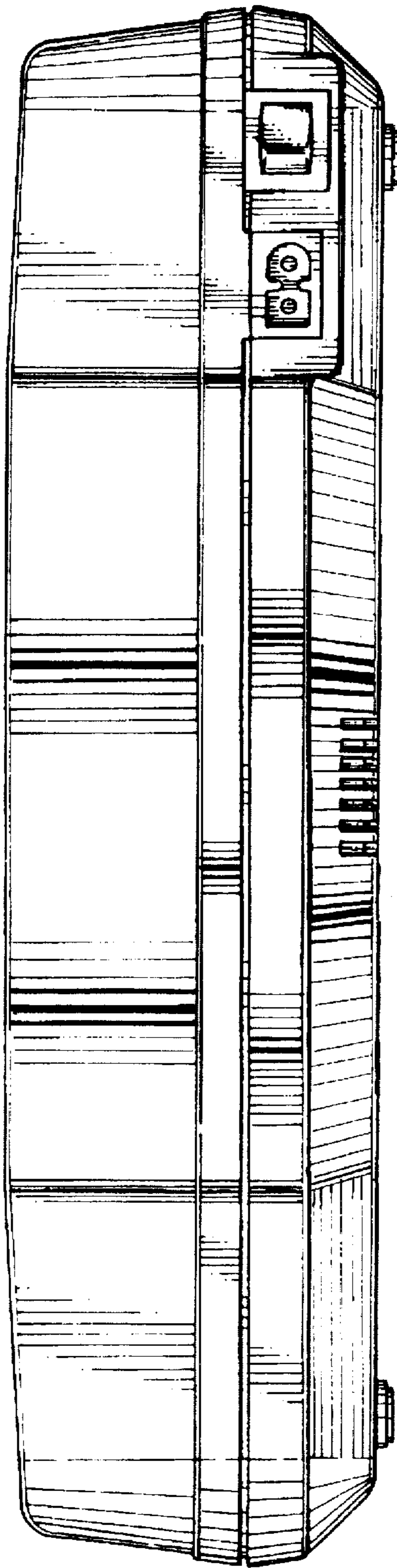

FIG. 3

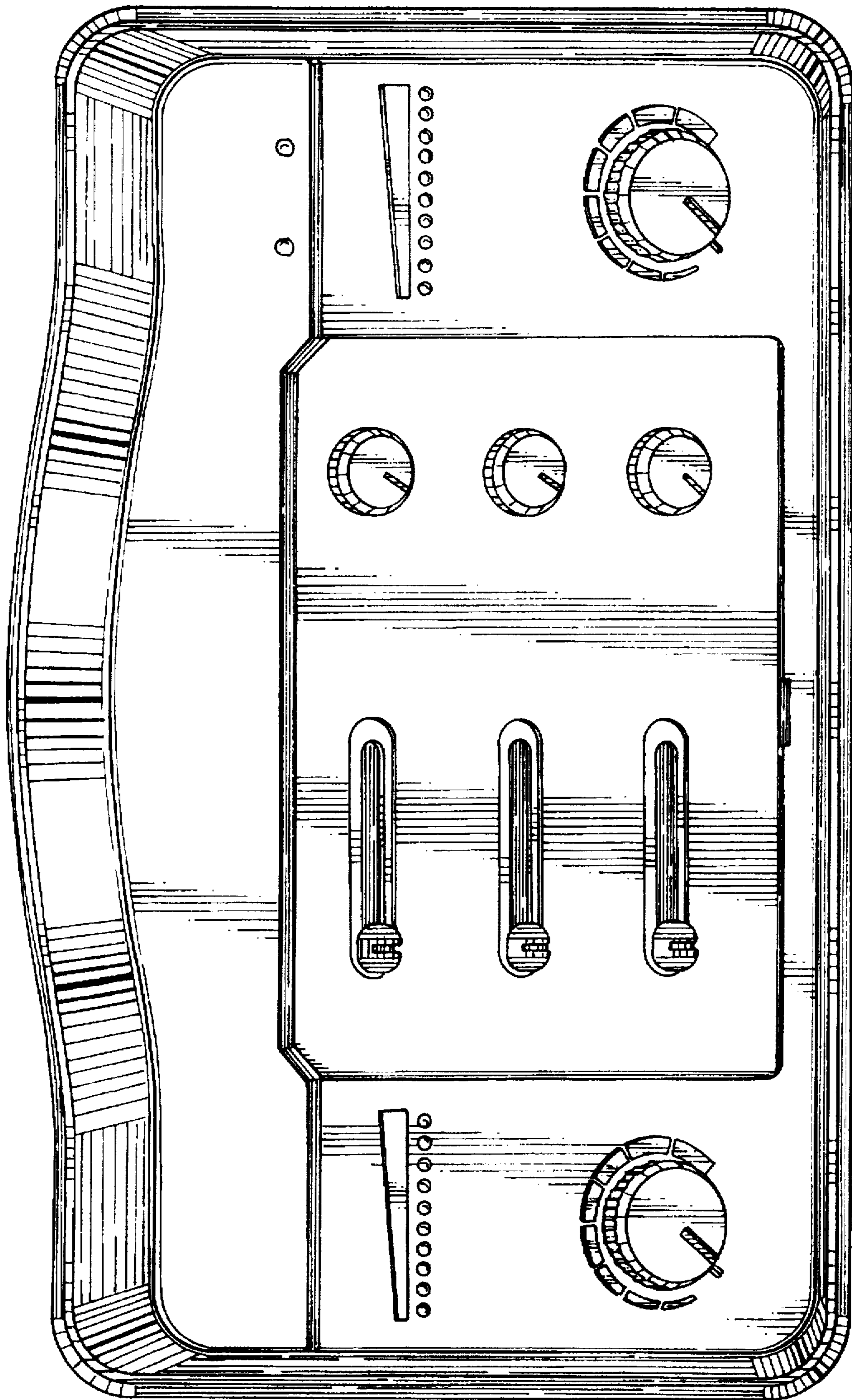

FIG. 4

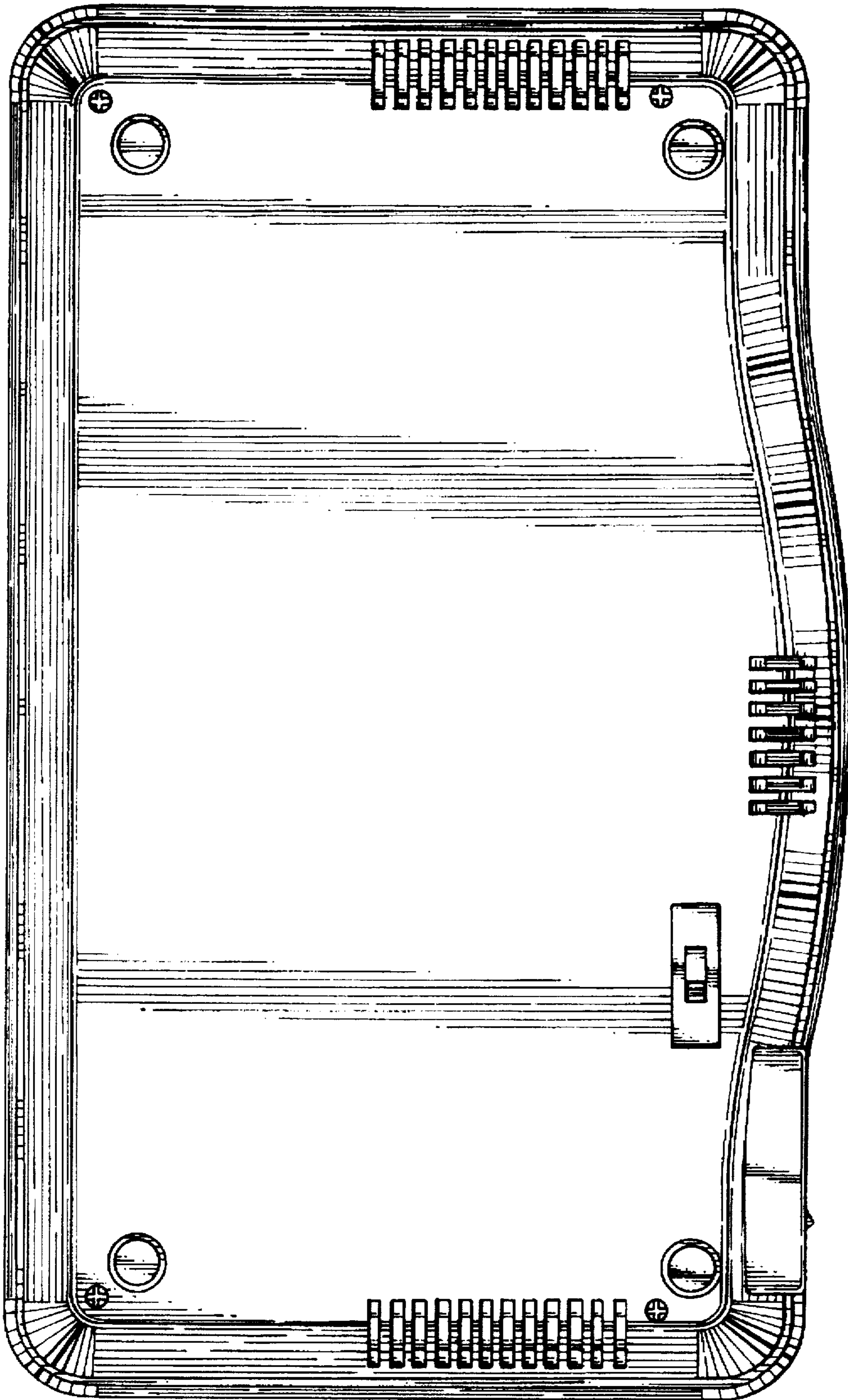

FIG. 5

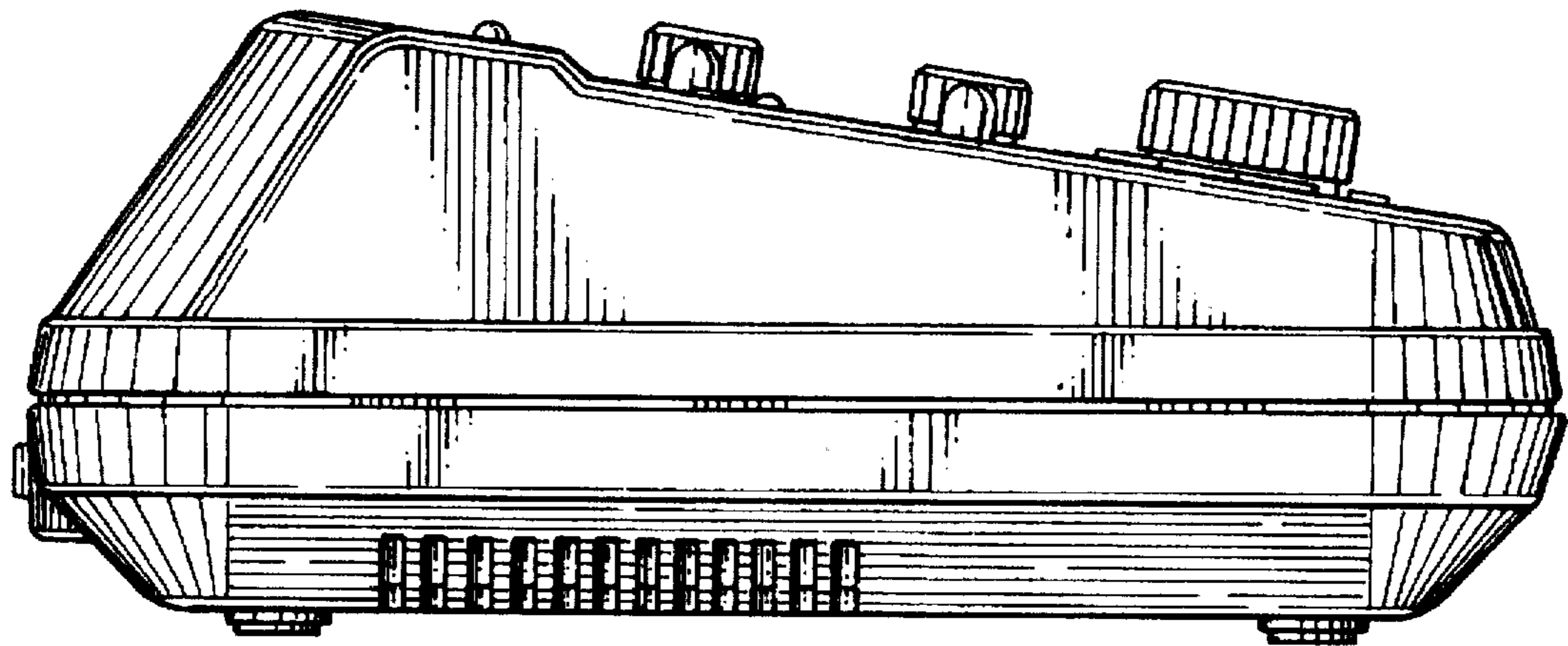

FIG. 6

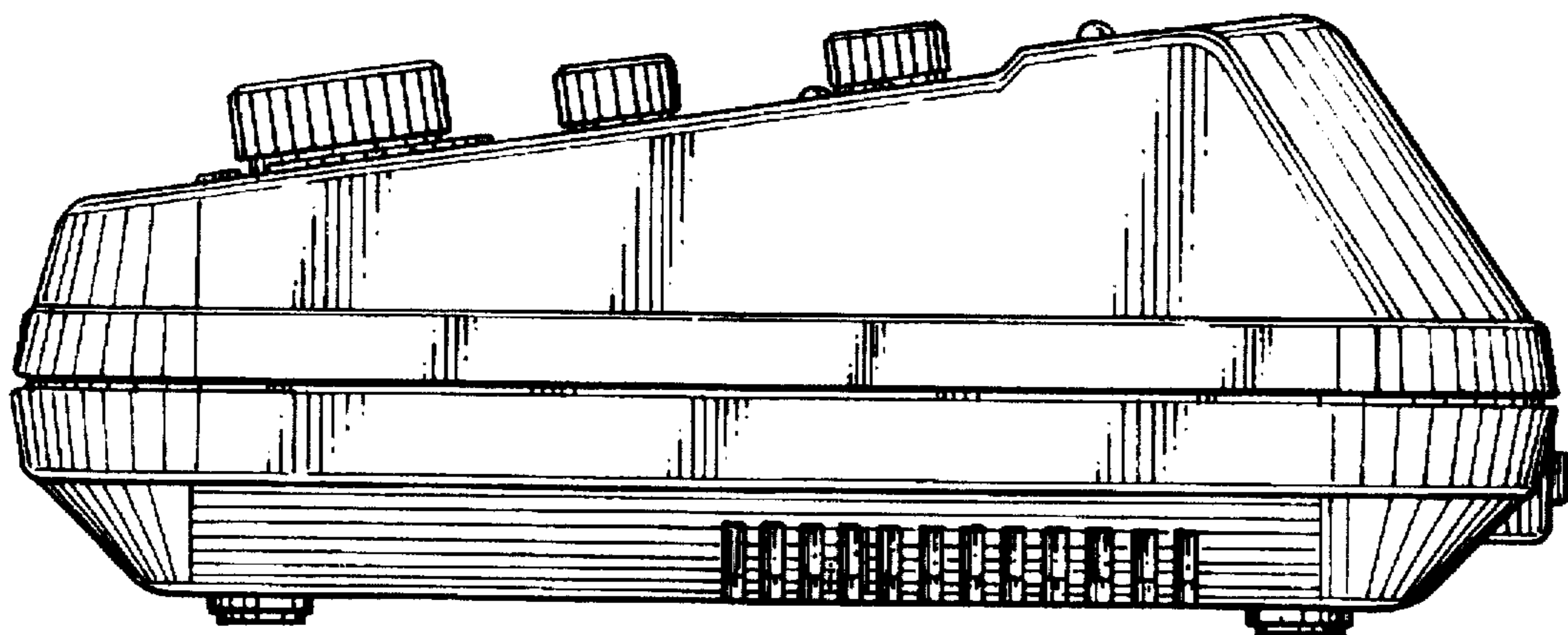

FIG. 7