



US00D386734S

**United States Patent** [19]  
**Nishimura**

[11] **Patent Number: Des. 386,734**

[45] **Date of Patent: \*\*Nov. 25, 1997**

[54] **BRAKE LEVER FOR A BICYCLE**  
[75] **Inventor: Tomohiko Nishimura, Osaka, Japan**  
[73] **Assignee: Shimano Inc., Osaka, Japan**  
[\*\*] **Term: 14 Years**

[21] **Appl. No.: 56,549**  
[22] **Filed: Jul. 2, 1996**

[51] **LOC (6) Cl. .... 12-16**  
[52] **U.S. Cl. .... D12/179**  
[58] **Field of Search .... D12/179; 74/415, 74/489, 475, 502.2, 551.8, 551.9, 523**

[56] **References Cited**

**U.S. PATENT DOCUMENTS**

D. 339,096	9/1993	Bean et al. ....	D12/179
D. 346,575	5/1994	Lussiec ....	D12/179
D. 365,061	12/1995	Gelbein ....	D12/179
D. 368,061	3/1996	Burns ....	D12/179
4,914,971	4/1990	Hinkens et al. ....	74/502.2
5,186,071	2/1993	Swasaki ....	74/475

5,385,070	1/1995	Tseng .....	74/502.2
5,481,934	1/1996	Tayawa .....	74/475

**OTHER PUBLICATIONS**

Colorado Cyclist, Summer 1996, pp. 40 & 41, the Avid SD-2.0 Brake Lever & Magura Classic Hydraulic Brakes.

*Primary Examiner*—Melody N. Brown  
*Attorney, Agent, or Firm*—Jordan and Hamburg

[57] **CLAIM**

The ornamental design for a brake lever for a bicycle, as shown and described.

**DESCRIPTION**

FIG. 1 is a perspective view of a first embodiment of a brake lever for a bicycle showing my new design;  
FIG. 2 is a front elevational view thereof;  
FIG. 3 is a rear elevational view thereof;  
FIG. 4 is a top plan view thereof;  
FIG. 5 is a bottom plan view thereof;  
FIG. 6 is a left side elevational view thereof; and,  
FIG. 7 is a right side elevational view thereof.

**1 Claim, 4 Drawing Sheets**

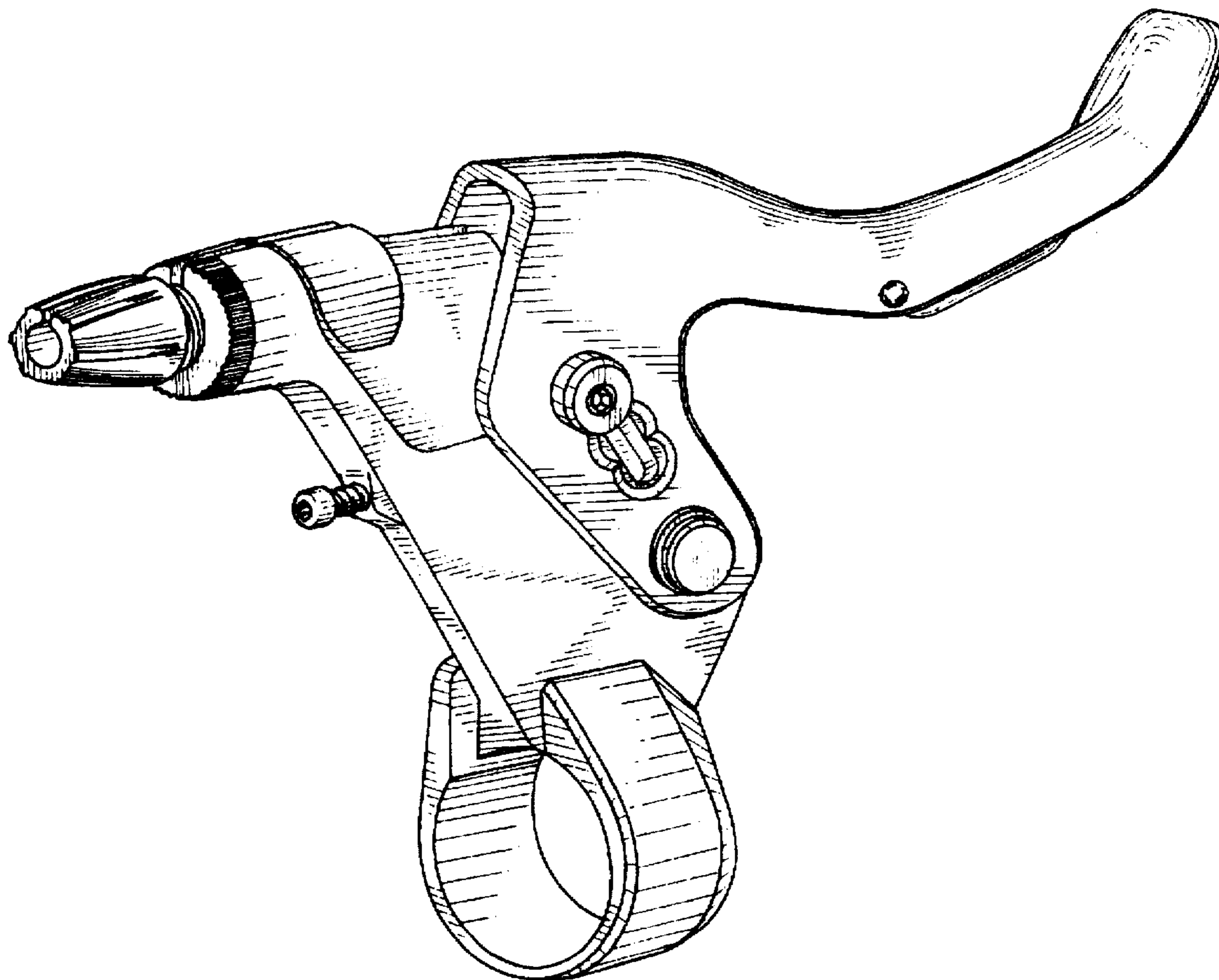

FIG . 1

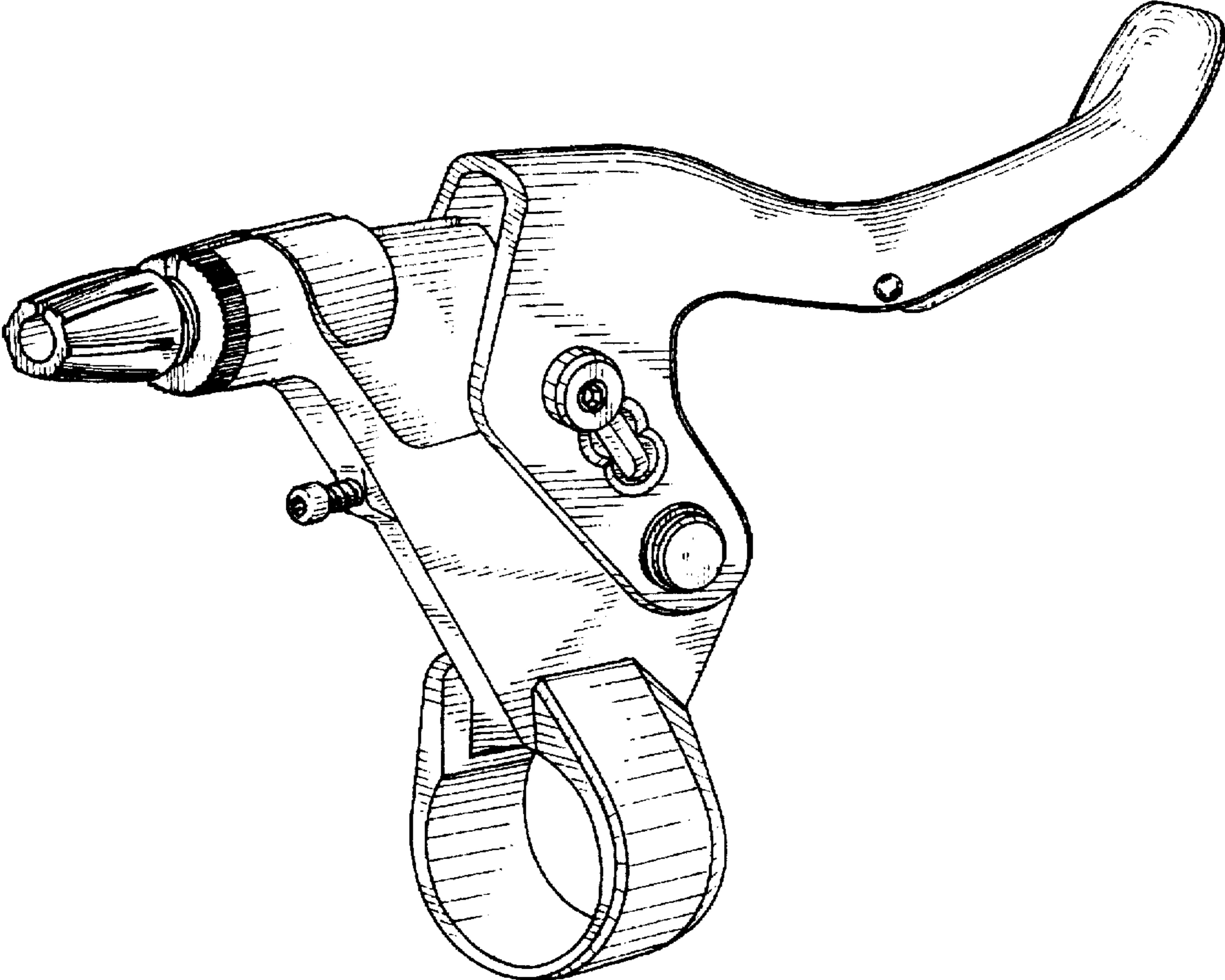

FIG. 2

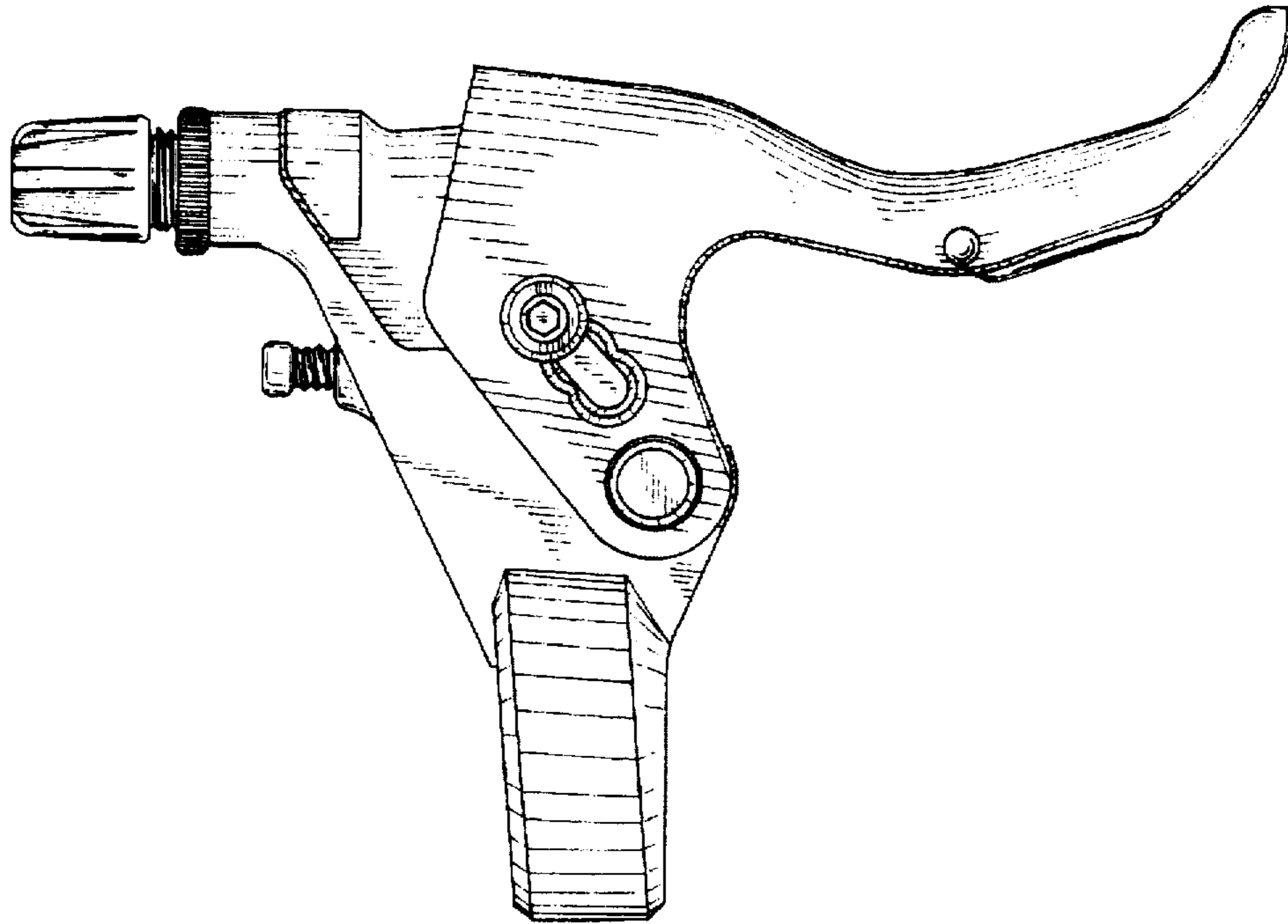

FIG. 3

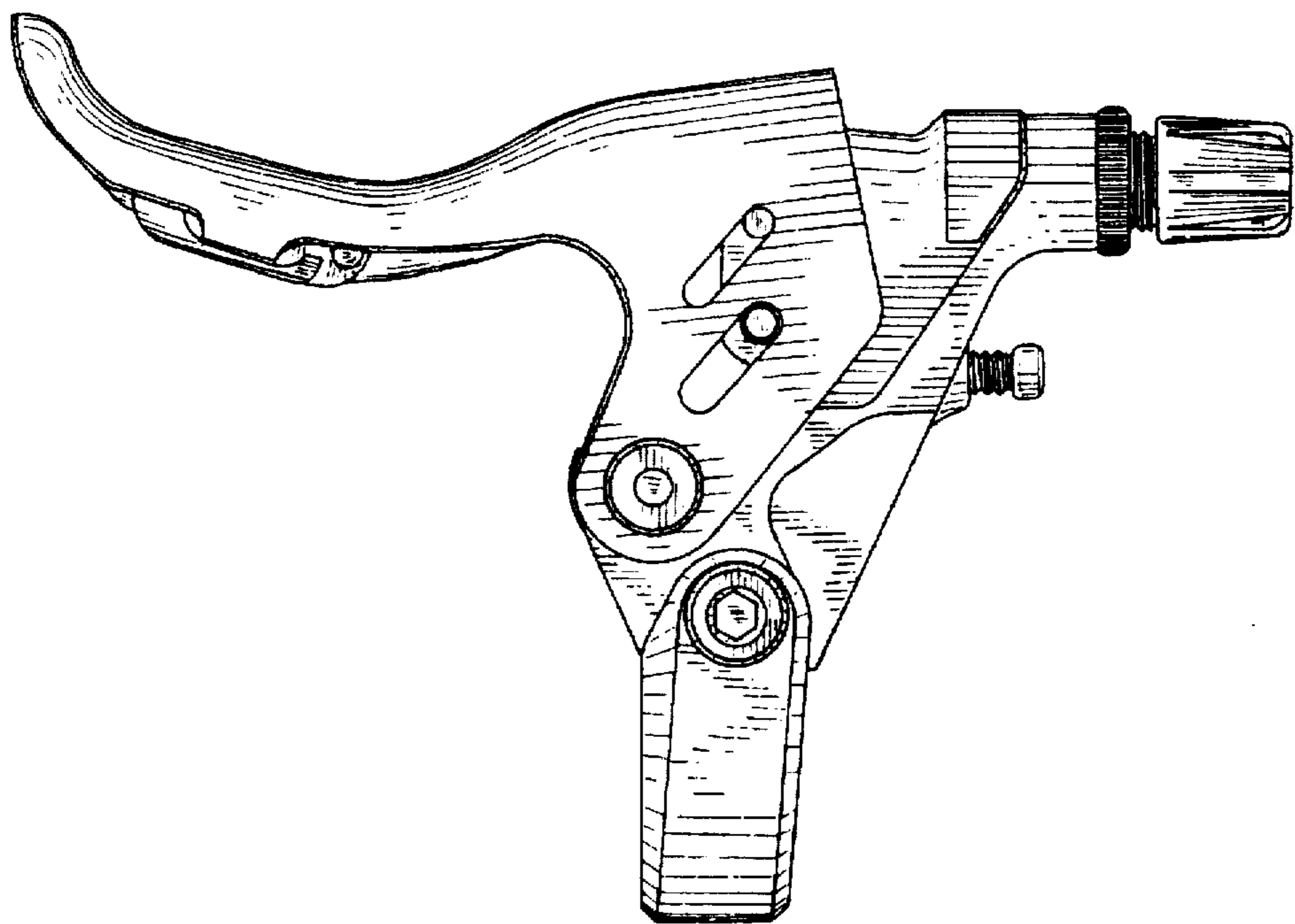

FIG. 4

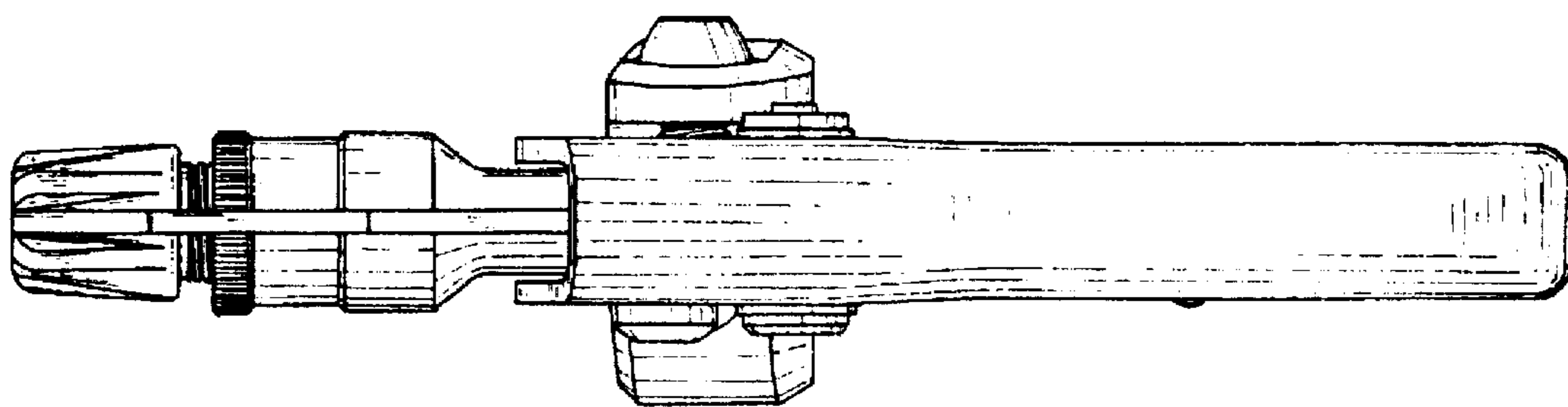

FIG. 5

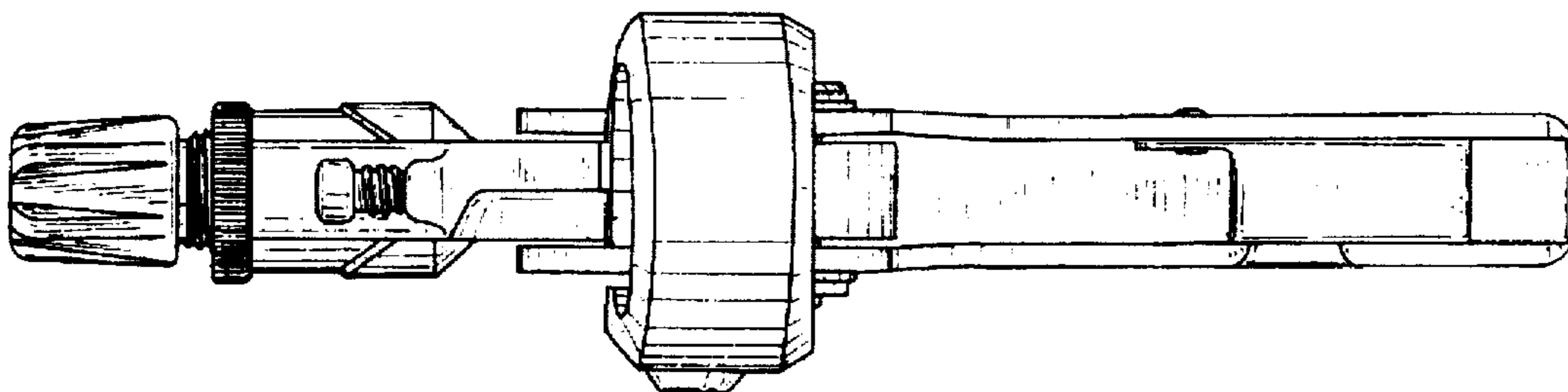

FIG. 6

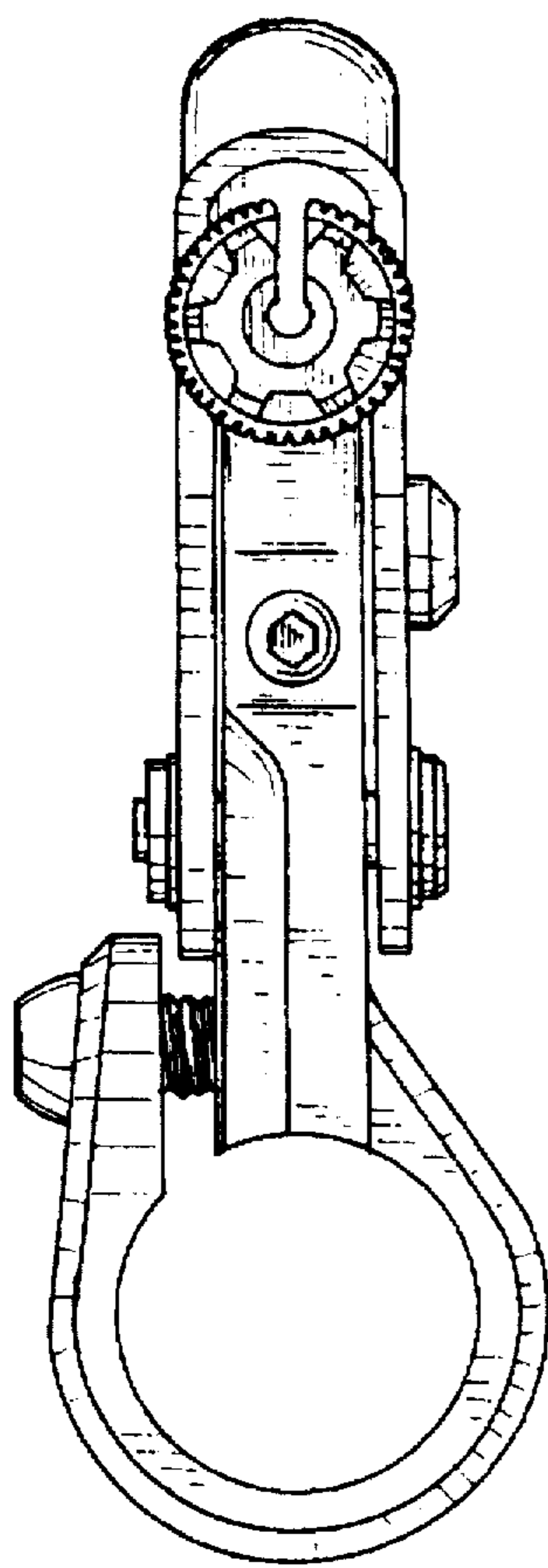

FIG. 7

