



US00D386717S

United States Patent [19]

Weder et al.

[11] Patent Number: Des. 386,717

[45] Date of Patent: ***Nov. 25, 1997

[54] **FLOWER POT COVER**

[75] Inventors: **Donald E. Weder; Joseph G. Straeter**, both of Highland, Ill.

[73] Assignee: **Southpac Trust International, Inc.**; not individually, but as trustee of The Family Trust U/T/A dated December 8, 1995, Charles A. Coddling, Authorized Signatory for Southpac Trust International, Inc. trustee

[*] Notice: The portion of the term of this patent subsequent to Nov. 29, 2008, has been disclaimed.

[**] Term: **14 Years**

[21] Appl. No.: **55,813**

[22] Filed: **May 3, 1996**

Related U.S. Application Data

[60] Division of Ser. No. 3,340, Jan. 5, 1993, Pat. No. Des. 371,519, which is a continuation-in-part of Ser. No. 808,560, Dec. 16, 1991, Pat. No. Des. 358,566, which is a continuation-in-part of Ser. No. 710,272, Jun. 4, 1991, Pat. No. Des. 365,302, which is a continuation-in-part of Ser. No. 617,454, Nov. 21, 1990, abandoned, and a continuation-in-part of Ser. No. 411,249, Sep. 22, 1989, Pat. No. Des. 358,113, and a continuation-in-part of Ser. No. 411,247, Sep. 22, 1989, abandoned, and a continuation-in-part of Ser. No. 411,245, Sep. 22, 1989, abandoned.

[51] **LOC (6) Cl.** **11-02**
[52] **U.S. Cl.** **D11/164**
[58] **Field of Search** D11/143, 149, D11/152-156, 164, 89, 90; 47/66, 72; 206/423; 215/100.5; 229/1.5 R, 1.5 B, 4.5, 108, 108.1, 109, 110, 87.01, 922, 930, 186, 189; 428/27, 35.1, 24, 542.6; 338/122; D9/346, 428-431; D27/102, 133; D26/128-136; D19/96; D7/540, 584, 586, 587, 354

[56] **References Cited**

U.S. PATENT DOCUMENTS

D. 005,120 7/1871 Snow D11/154 X

D. 005,806	4/1872	Palmer	D11/154
D. 050,435	3/1917	Stimpson	D11/143 X
D. 114,182	4/1939	Heisey	D11/154
D. 139,009	10/1944	Denenberg	D26/134
D. 174,733	5/1955	Bordman	D26/136
D. 292,182	10/1987	Weder et al.	D11/164
D. 292,562	11/1987	Weder et al.	D11/164
D. 293,224	12/1987	Weder et al.	D11/164
D. 293,775	1/1988	Weder et al.	D11/164
D. 317,583	6/1991	Weder et al.	D11/164
D. 318,030	7/1991	Weder et al.	D11/164
D. 318,635	7/1991	Weder et al.	D11/164
D. 327,234	6/1992	Vaughn	D11/143
D. 352,918	11/1994	Weder et al.	D11/164
D. 356,755	3/1995	Weder et al.	D11/164
D. 358,565	5/1995	Weder et al.	D11/164
D. 358,566	5/1995	Weder et al.	D11/164
D. 364,584	11/1995	Weder et al.	D11/164
D. 366,630	1/1996	Weder et al.	D11/164
D. 370,644	6/1996	Weder et al.	D11/164
D. 371,091	6/1996	Weder et al.	D11/164
D. 371,519	7/1996	Weder et al.	D11/164
2,334,805	11/1943	Barbieri	229/1.5 B
2,355,559	8/1944	Renner	229/8
5,127,817	7/1992	Weder et al.	425/383
5,184,390	2/1993	Weder	215/100.5 X

FOREIGN PATENT DOCUMENTS

103316 3/1938 Australia 229/922

OTHER PUBLICATIONS

Exhibit A-Speed Cover® Brochure -The Simple Solution . . . , ©1989.

Primary Examiner—Jeffrey Asch
Attorney, Agent, or Firm—Dunlap & Coddling, P.C.

[57] **CLAIM**

The ornamental design for a flower pot cover, as shown and described.

DESCRIPTION

FIG. 1 is a perspective view of our new flower pot cover design;

FIG. 2 is a side elevational view thereof;

FIG. 3 is a top plan view thereof;

FIG. 4 is a bottom plan view thereof;

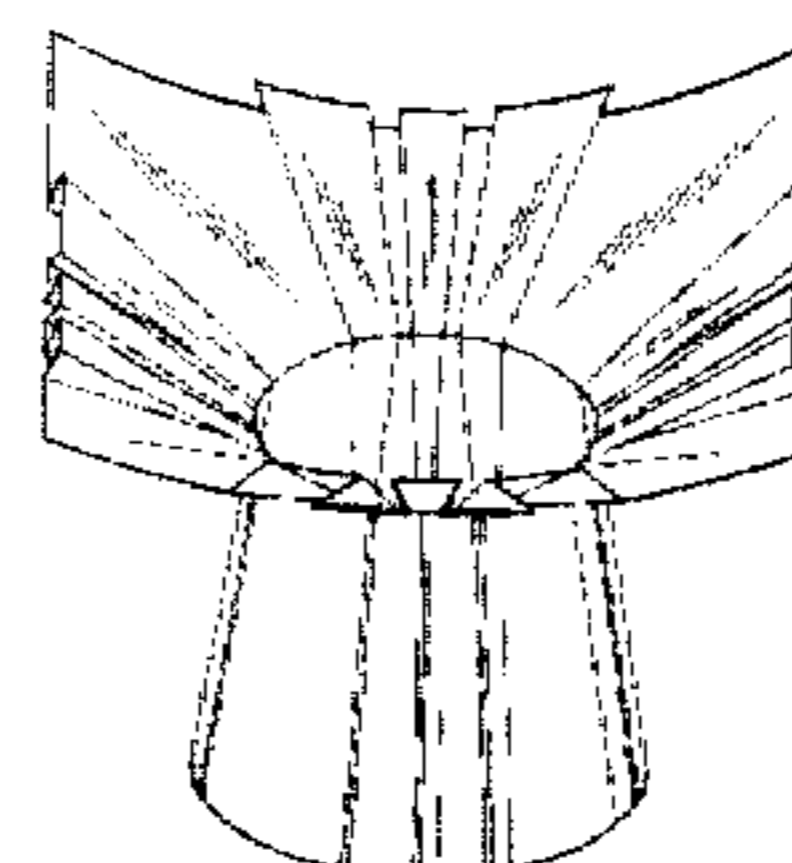
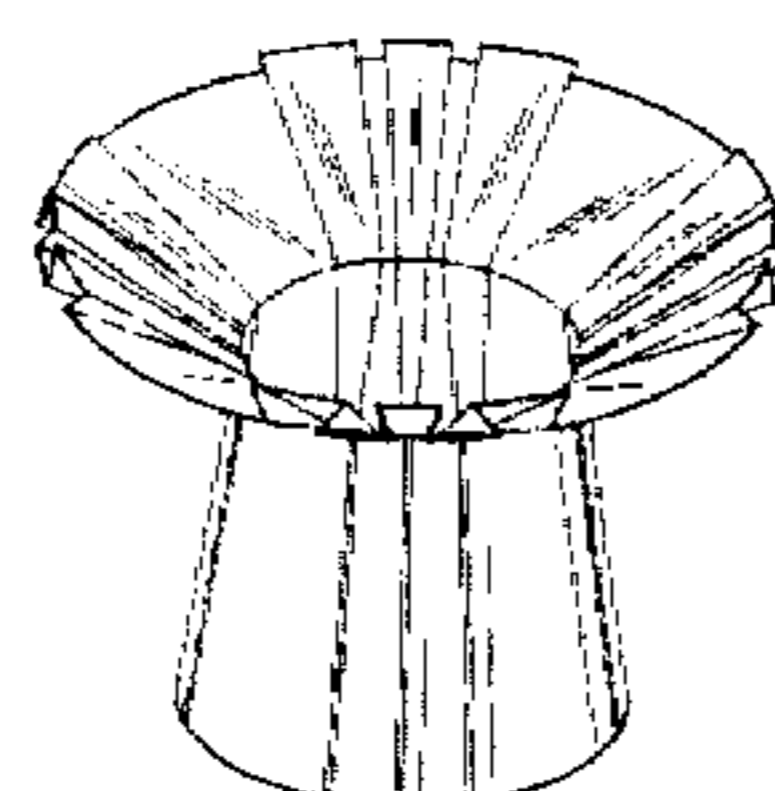
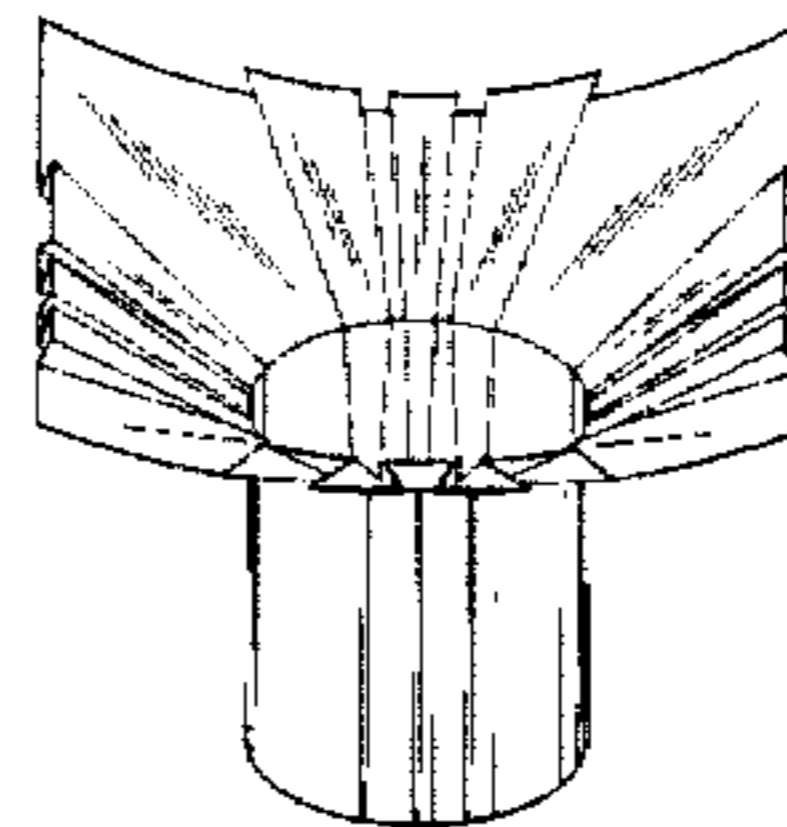
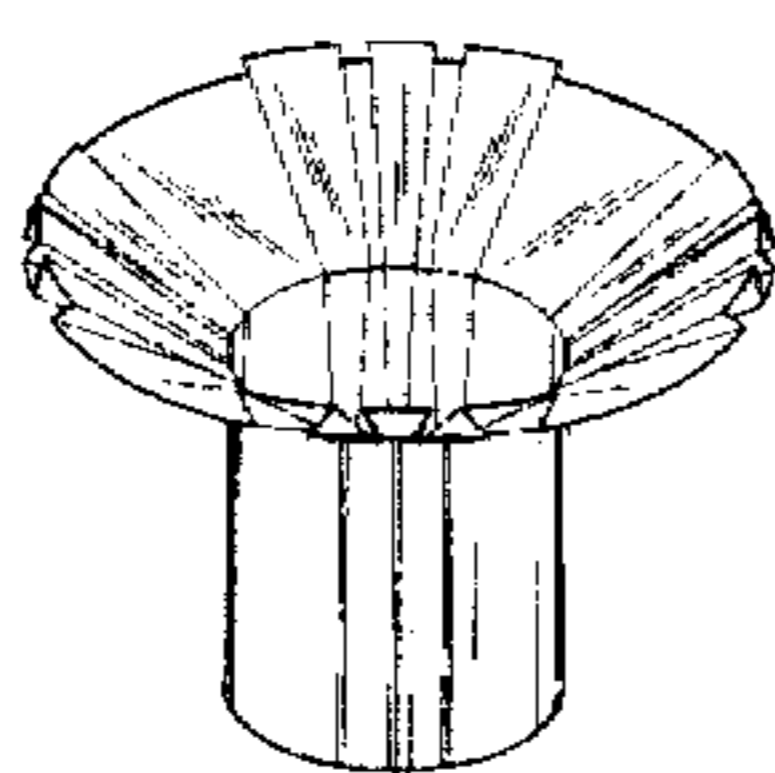

FIG. 5 is a side elevational view of the design of FIG. 1, the only difference being in the horizontal angle of the skirt;
FIG. 6 is a side elevational view of the design of FIG. 1, the only difference being in the near vertical angle of the skirt;
FIG. 7 is a side elevational view of the design of FIG. 1, the only difference being in the downward angle of the skirt;
FIG. 8 is a perspective view of a second embodiment of our new flower pot cover design;
FIG. 9 is a side elevational view thereof;
FIG. 10 is a top plan view thereof;
FIG. 11 is a bottom plan view thereof;
FIG. 12 is a side elevational view of the design of FIG. 8, the only difference being in the horizontal angle of the skirt;
FIG. 13 is a side elevational view of the design of FIG. 8, the only difference being in the near vertical angle of the skirt;
FIG. 14 is a side elevational view of the design of FIG. 8, the only difference being in the downward angle of the skirt;
FIG. 15 is a perspective view of a third embodiment of our new flower pot cover design;
FIG. 16 is a side elevational view thereof;
FIG. 17 is a top plan view thereof;
FIG. 18 is a bottom plan view thereof;

FIG. 19 is a side elevational view of the design of FIG. 15, the only difference being in the horizontal angle of the skirt;
FIG. 20 is a side elevational view of the design of FIG. 15, the only difference being in the near vertical angle of the skirt;
FIG. 21 is a side elevational view of the design of FIG. 15, the only difference being in the downward angle of the skirt;
FIG. 22 is a perspective view of a fourth embodiment of our new flower pot cover design;
FIG. 23 is a side elevational view thereof;
FIG. 24 is a top plan view thereof;
FIG. 25 is a bottom plan view thereof;
FIG. 26 is a side elevational view of the design of FIG. 22, the only difference being in the horizontal angle of the skirt;
FIG. 27 is a side elevational view of the design of FIG. 22, the only difference being in the near vertical angle of the skirt; and,
FIG. 28 is a side elevational view of the design of FIG. 22, the only difference being in the downward angle of the skirt.
The flower pot cover has no substantial thickness.

1 Claim, 8 Drawing Sheets

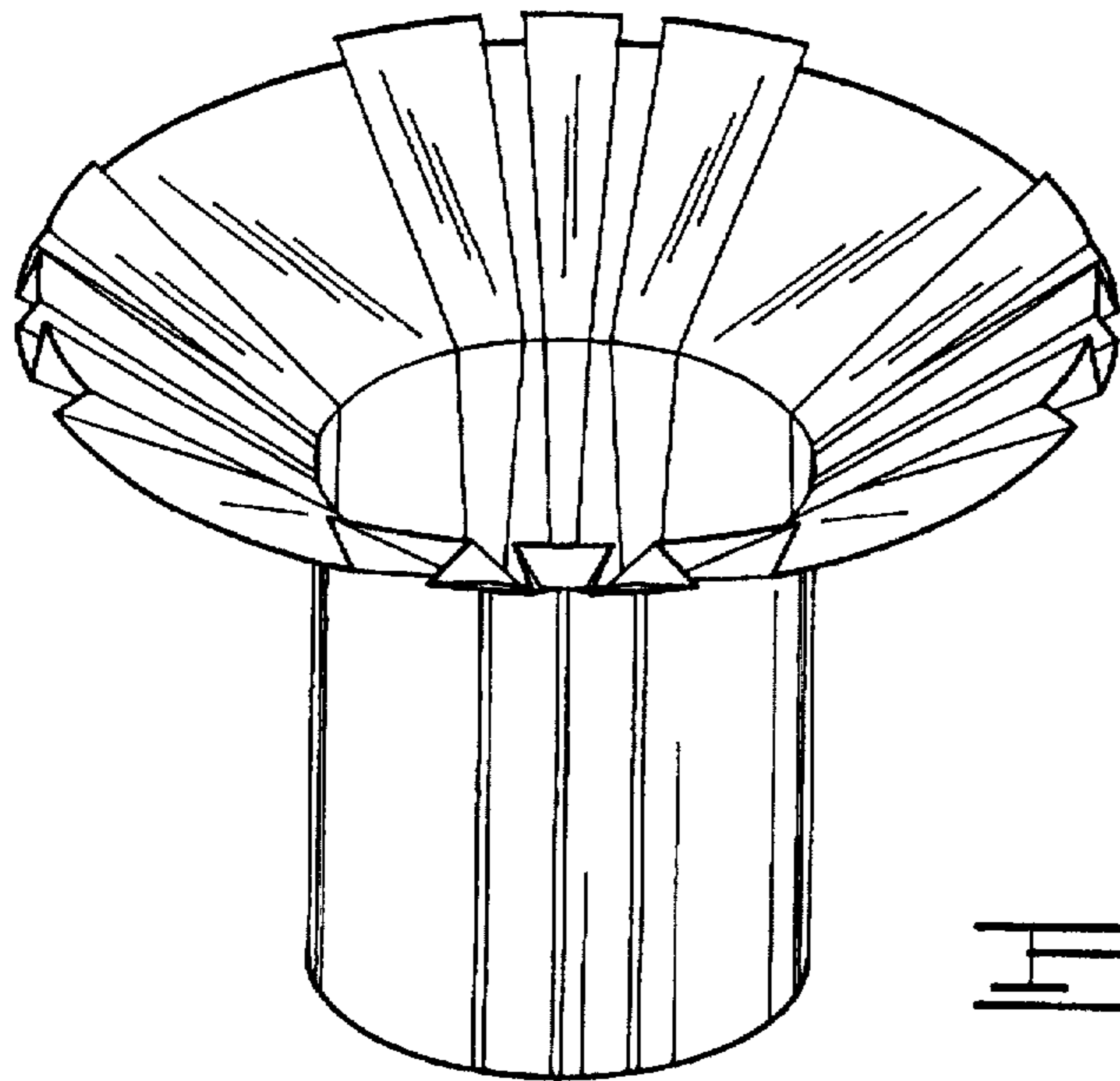

FIG. 1

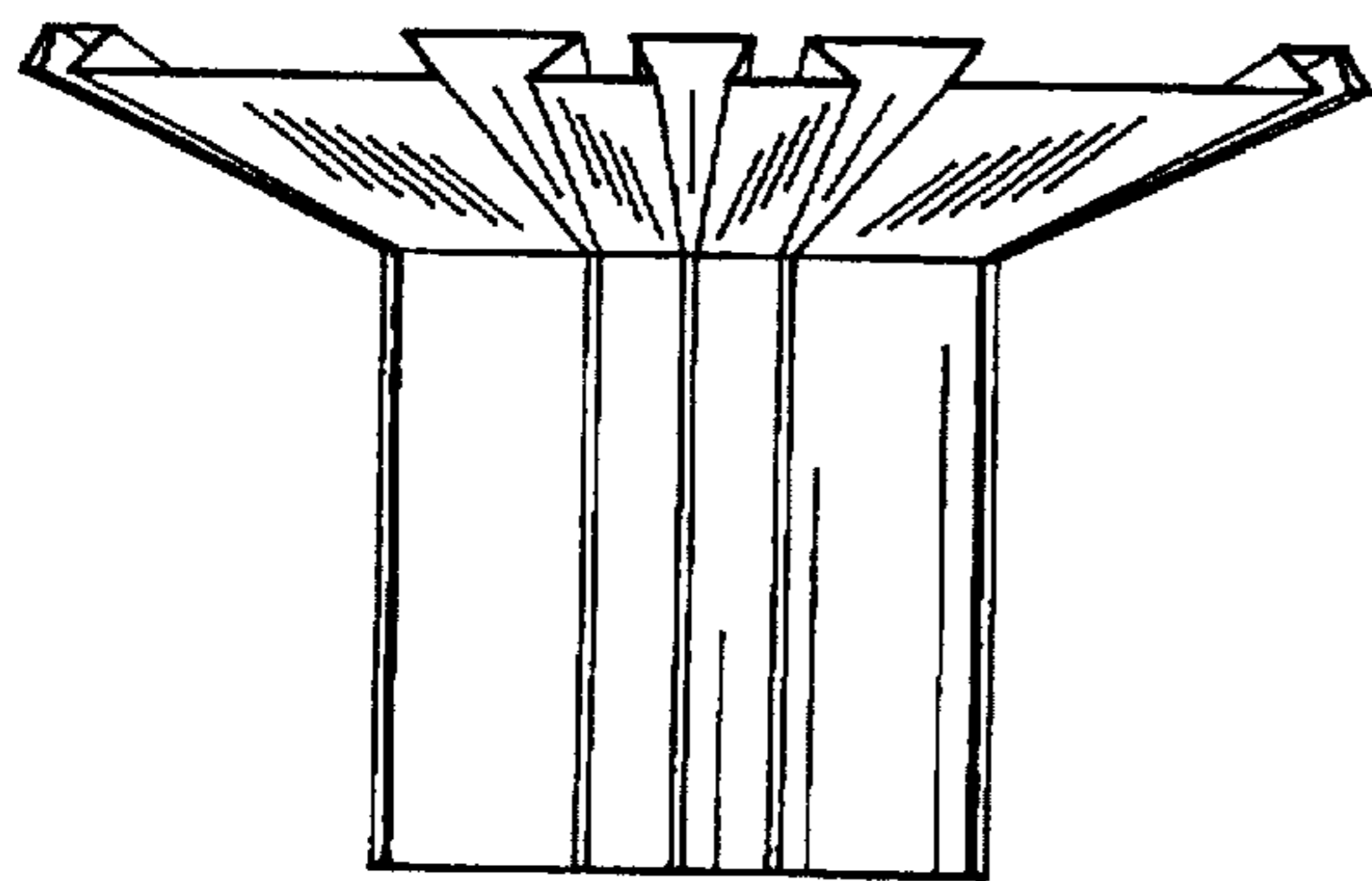

FIG. 2

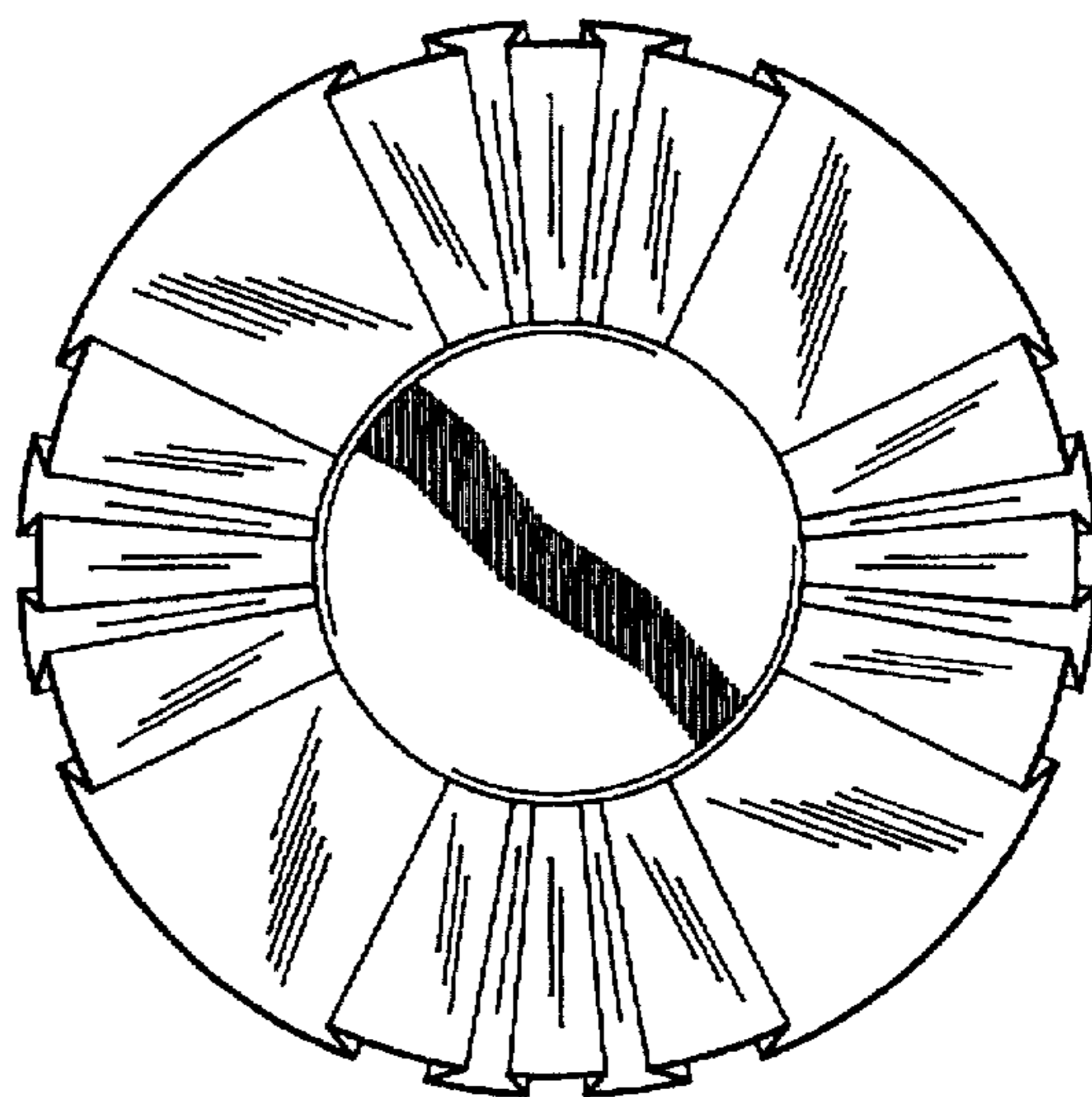

FIG. 3

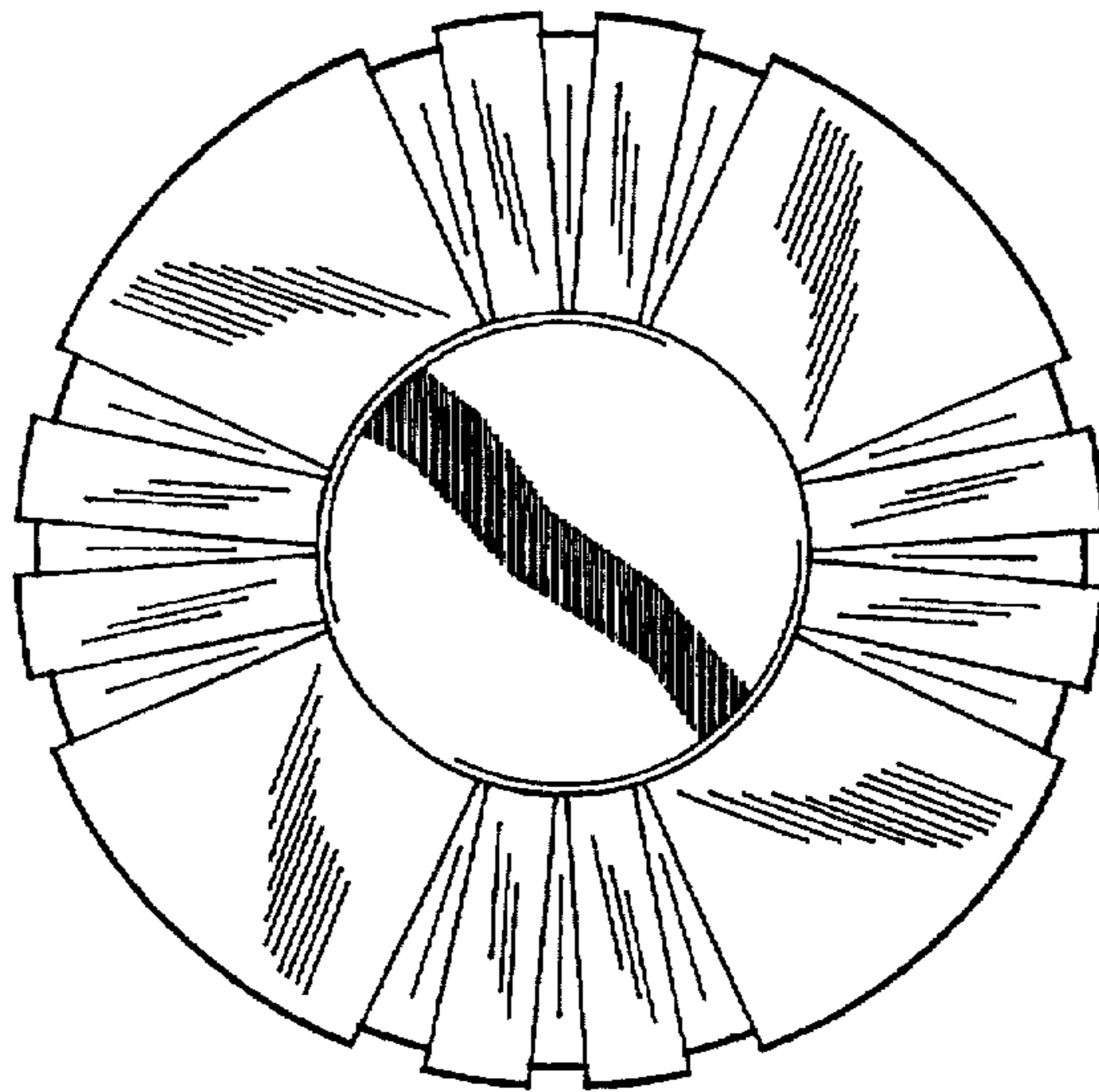

FIG. 4

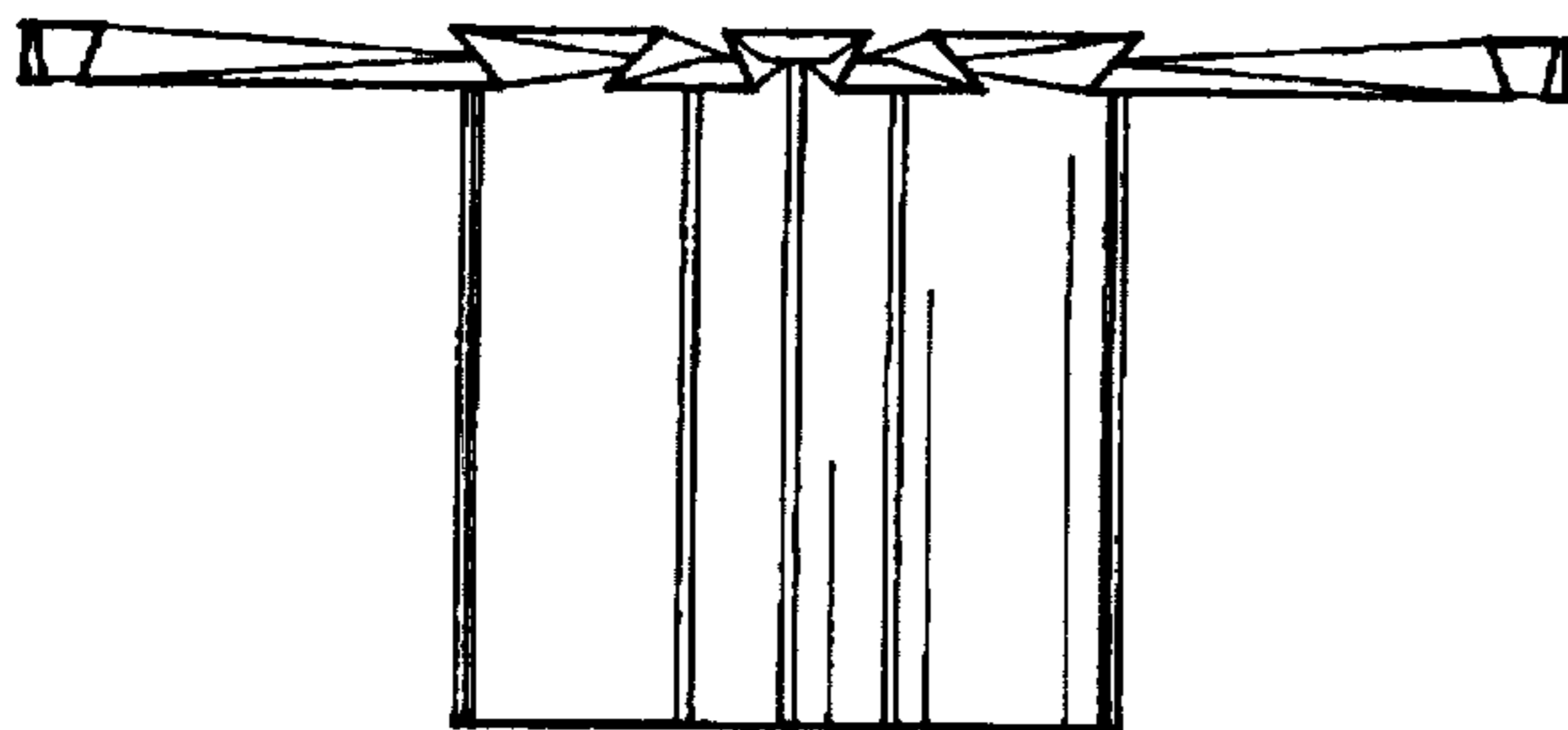

FIG. 5

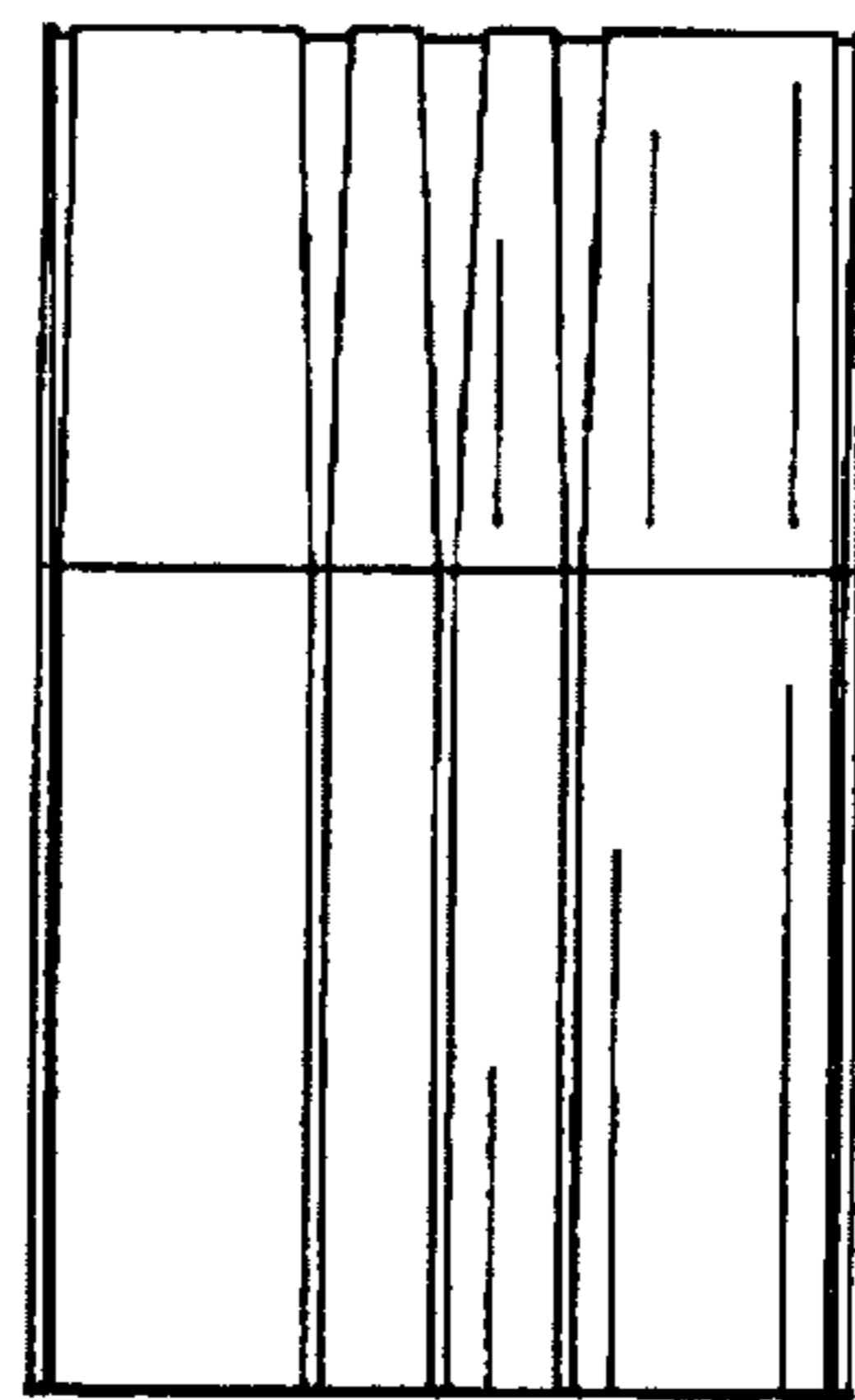

FIG. 6

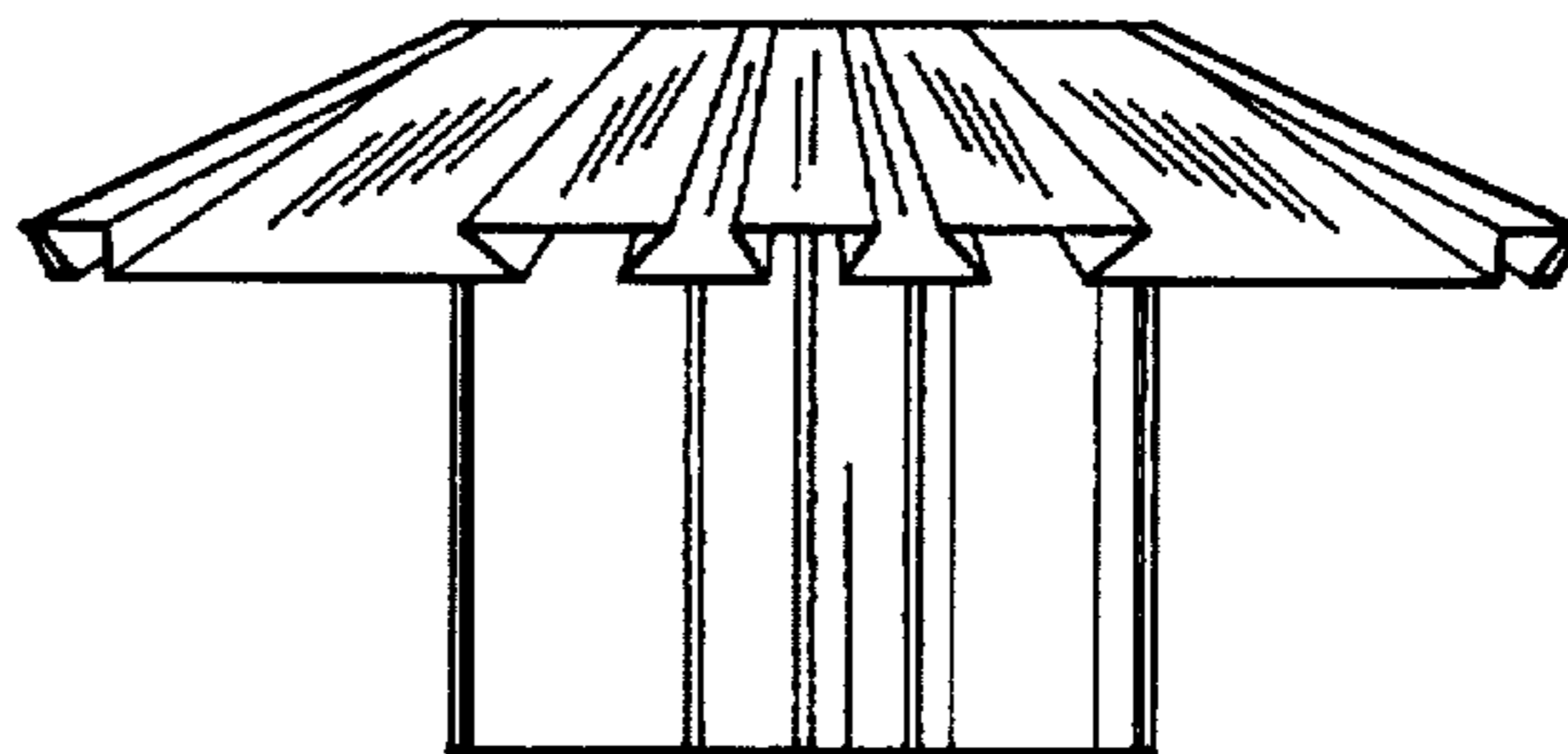
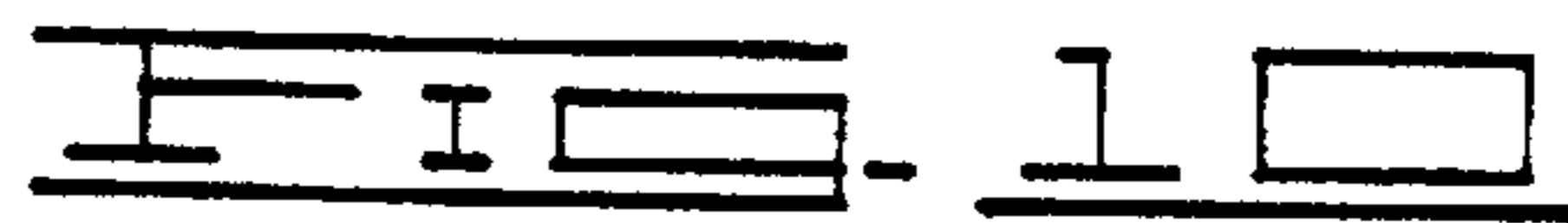
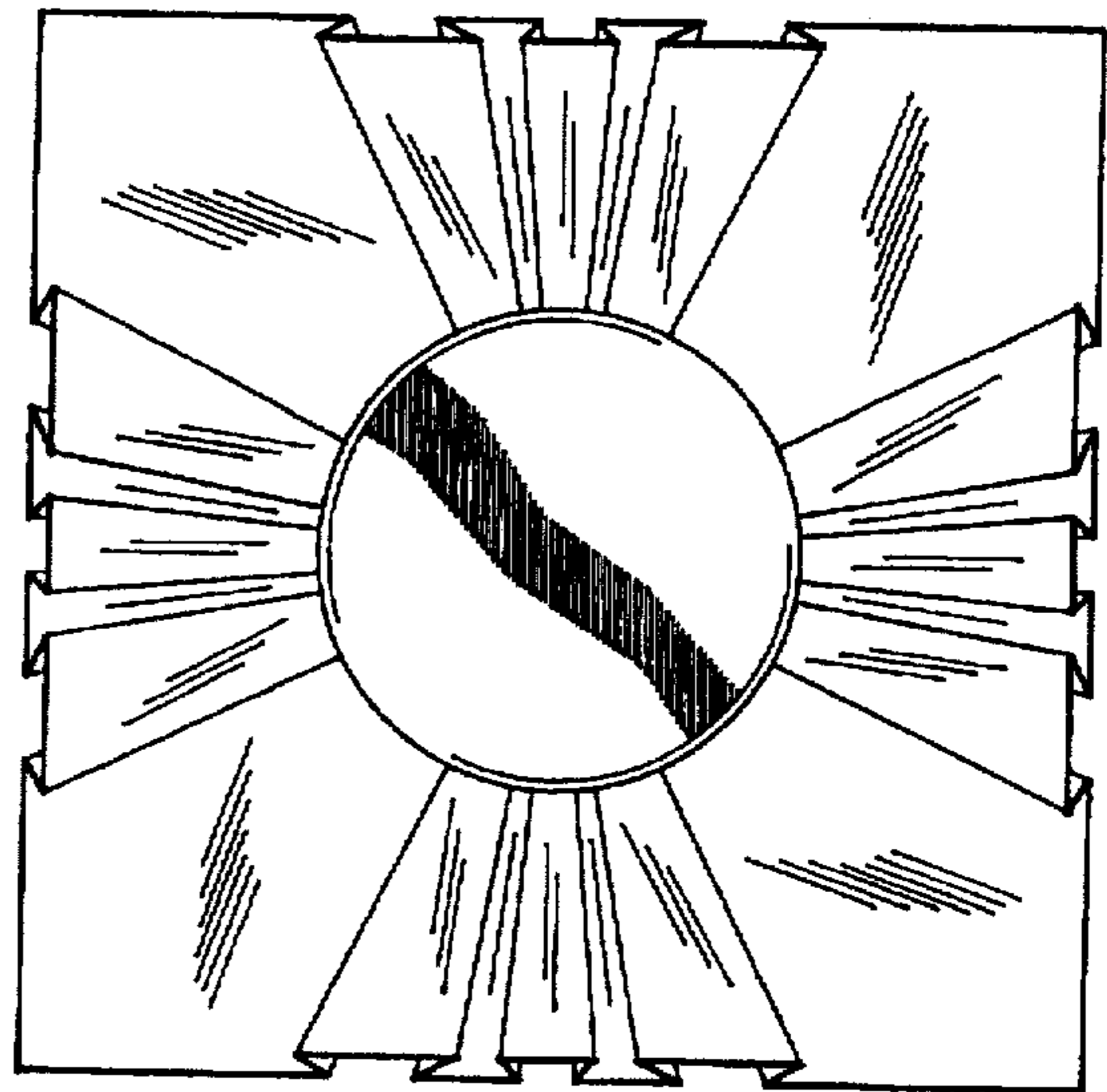
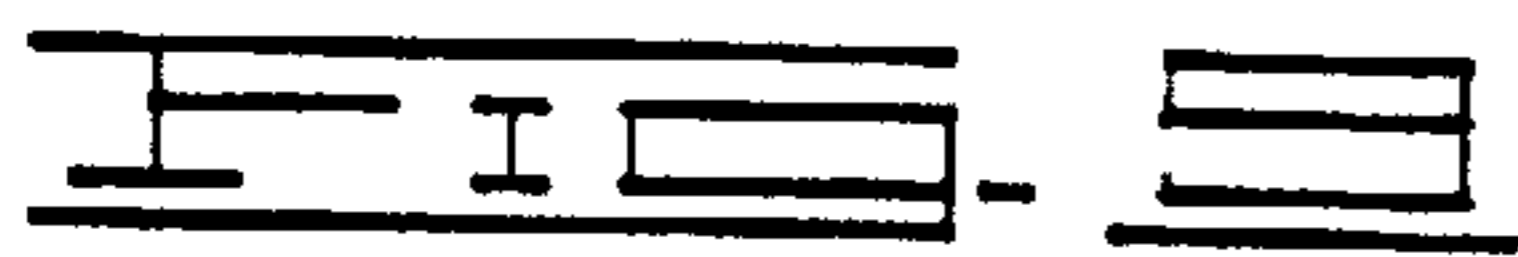
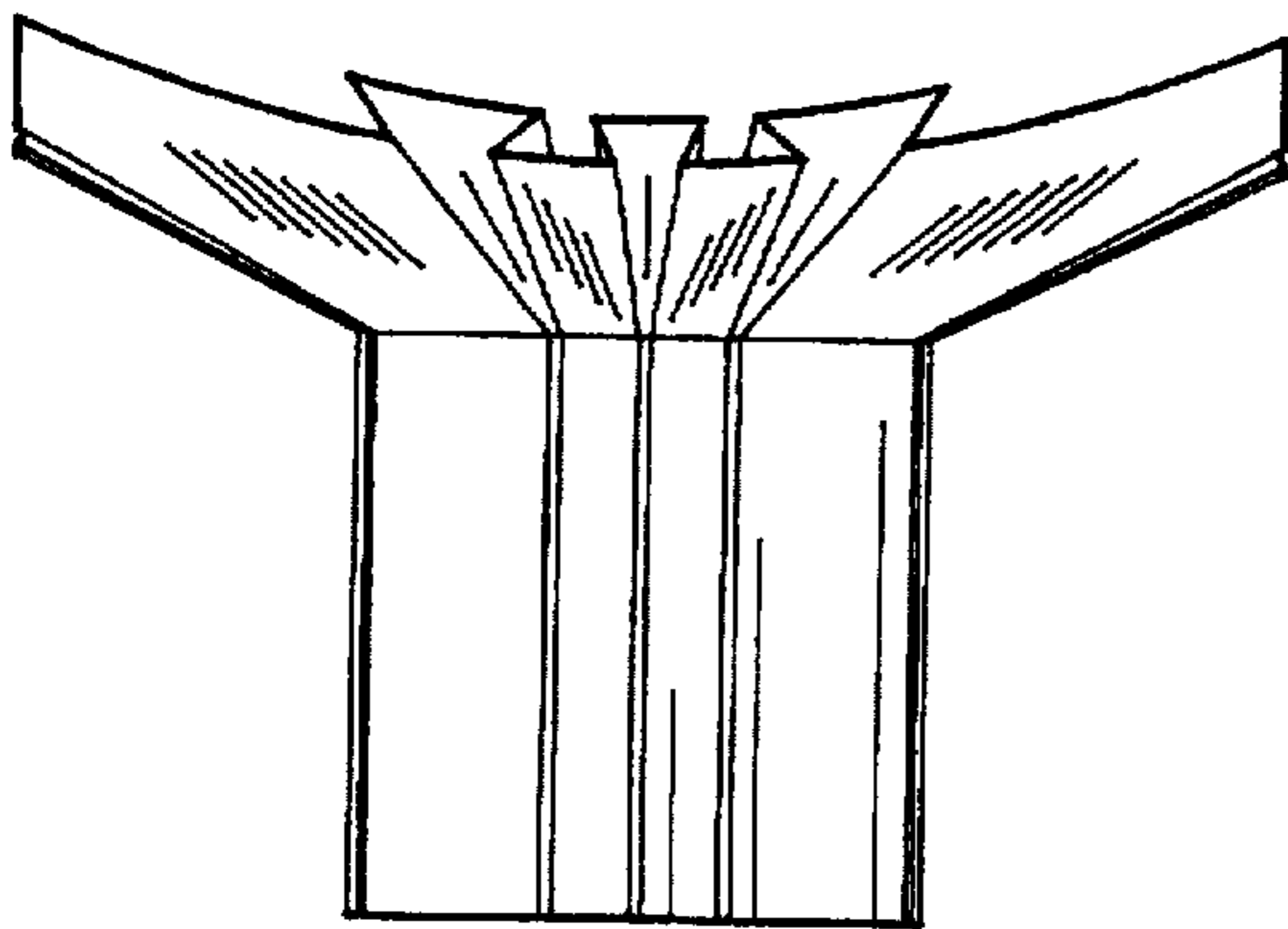
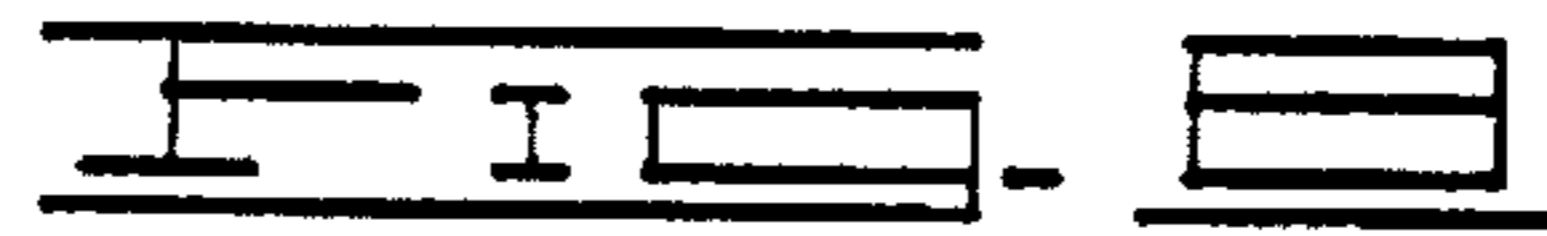
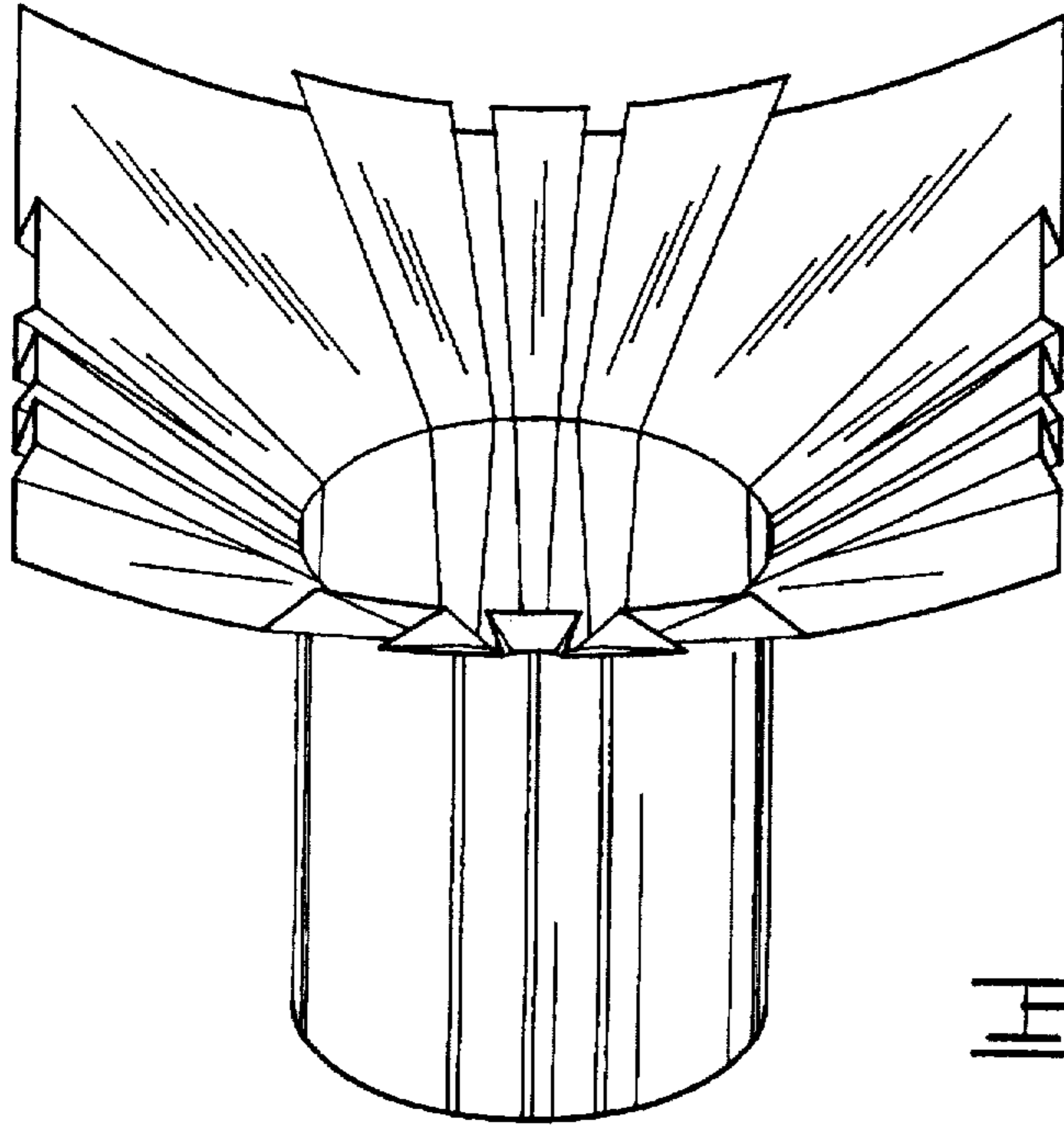

FIG. 7



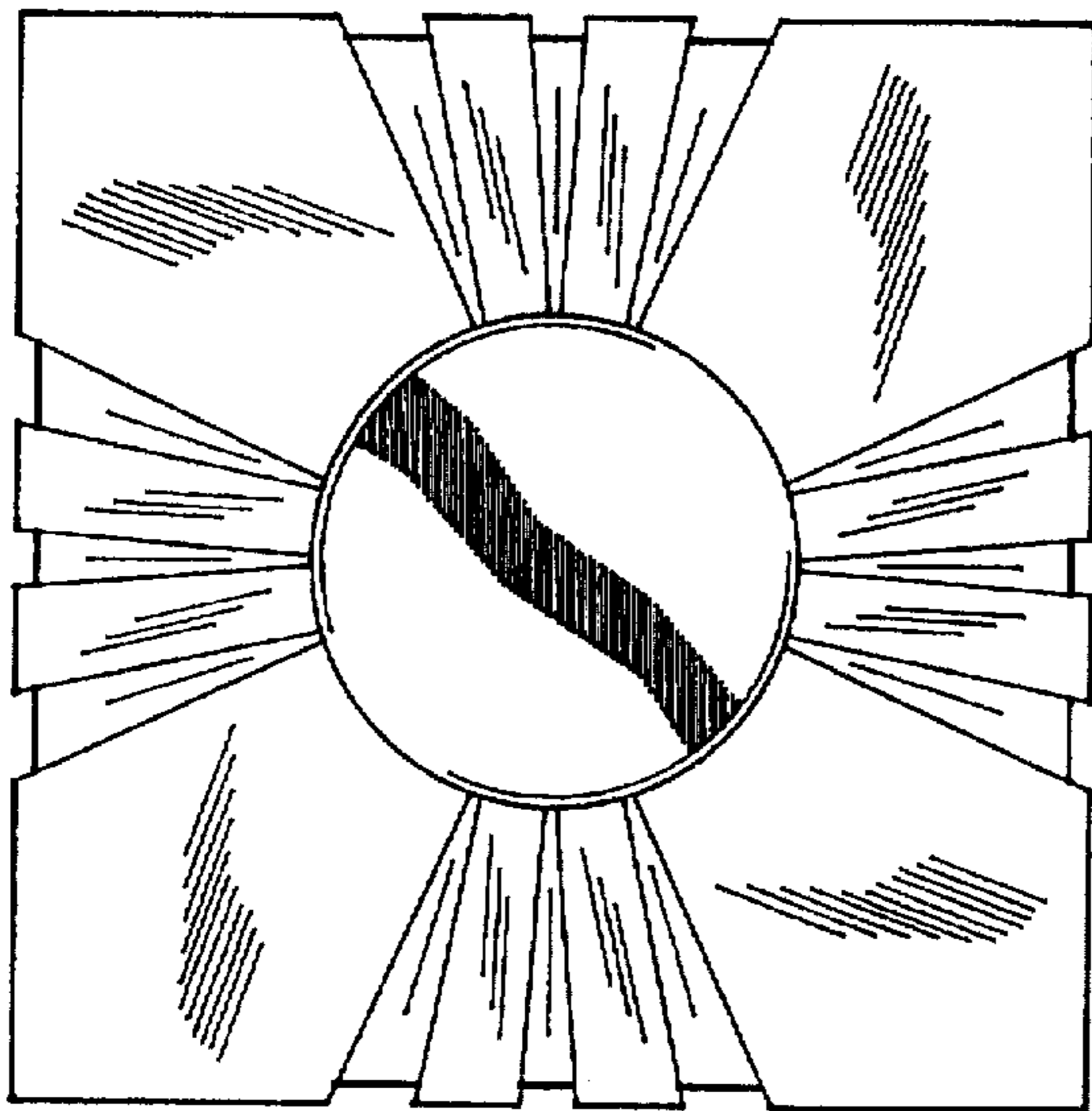

FIG. 11

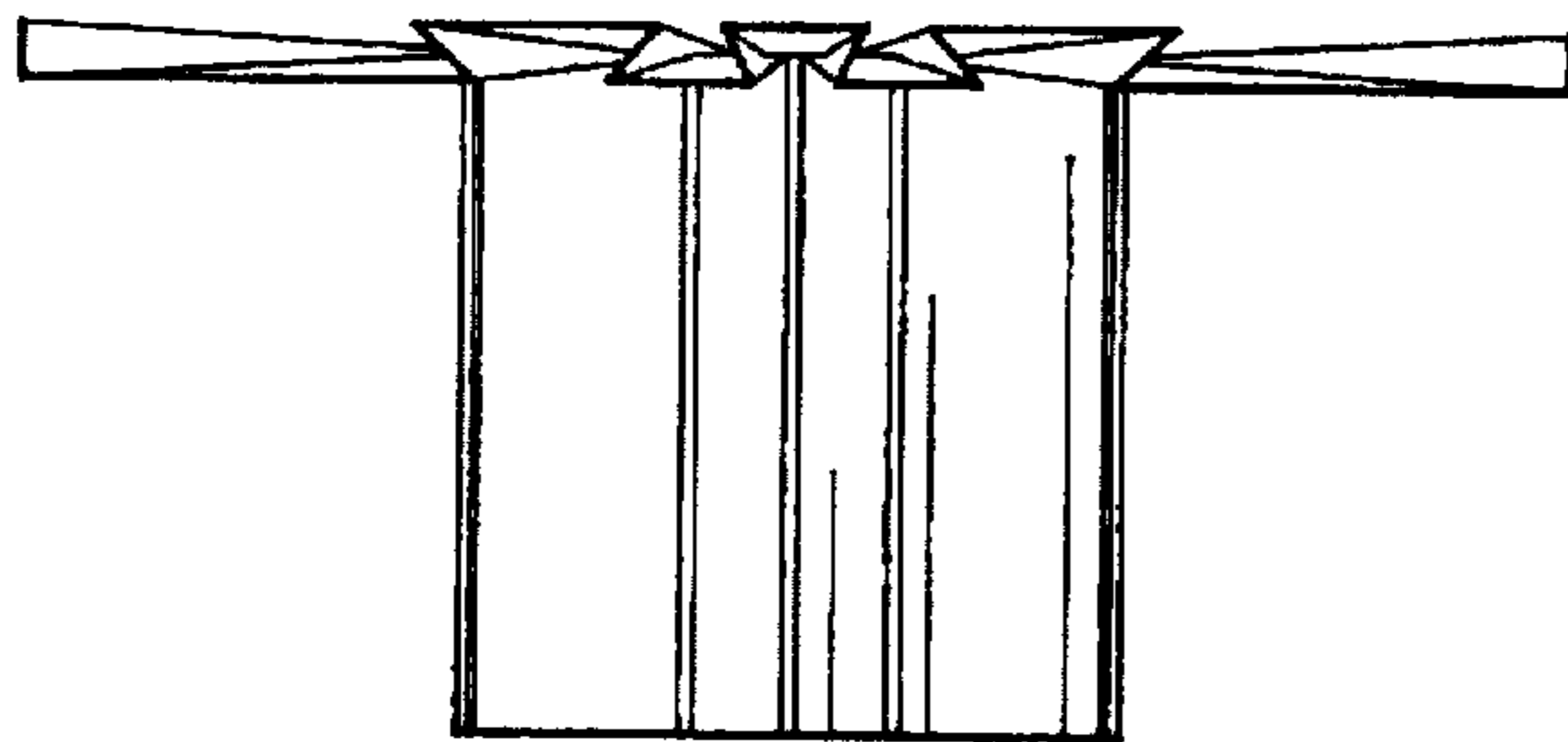

FIG. 12

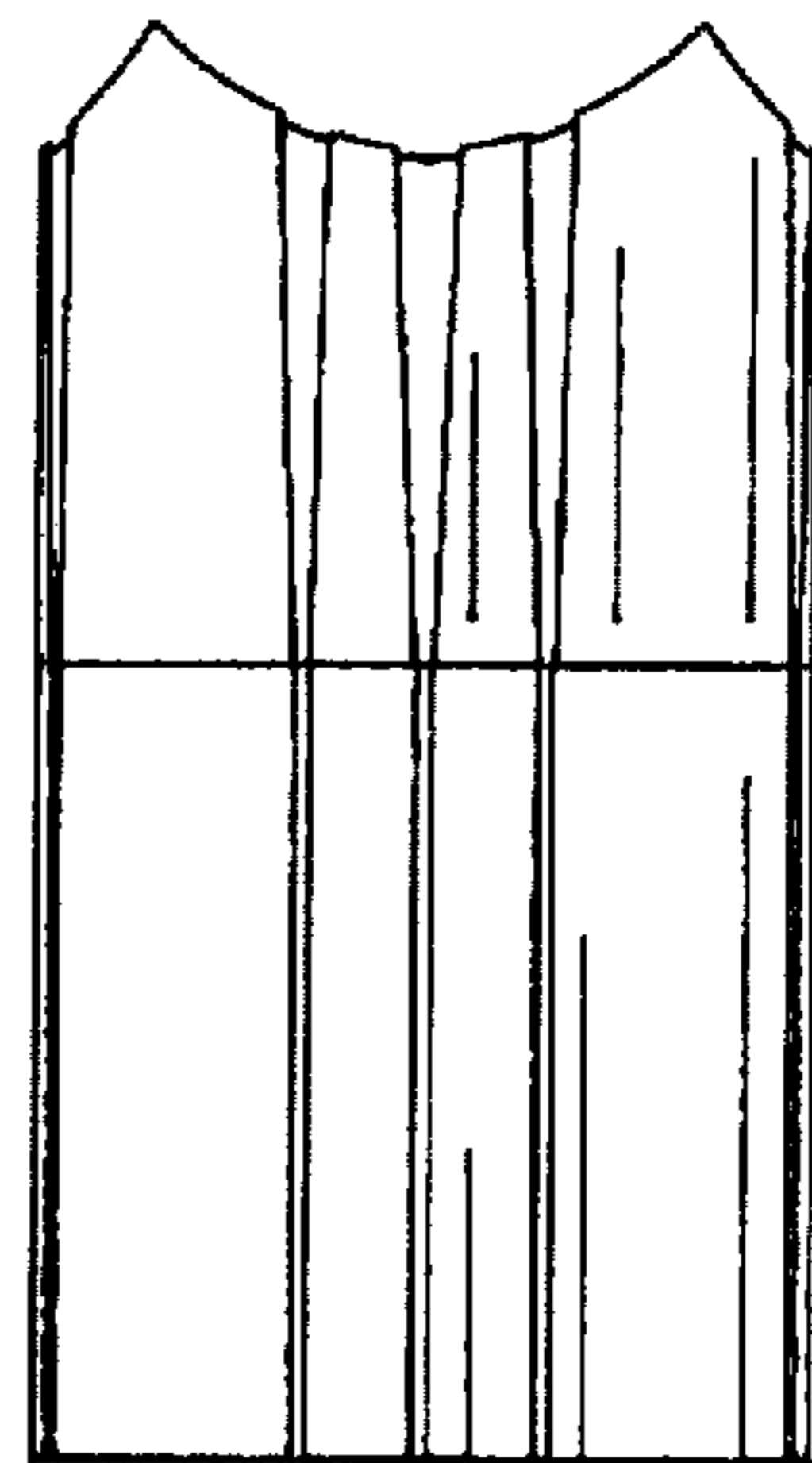

FIG. 13

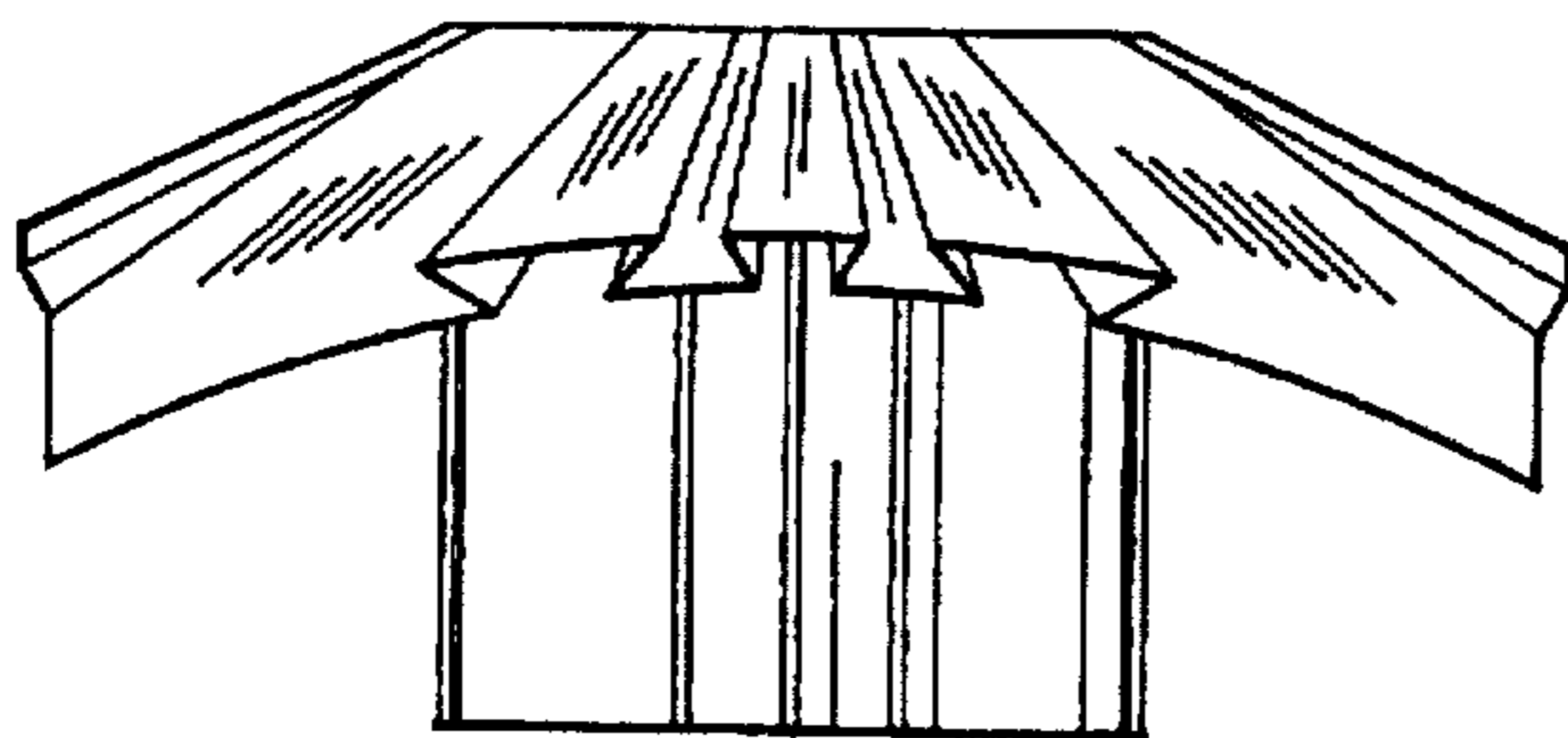

FIG. 14

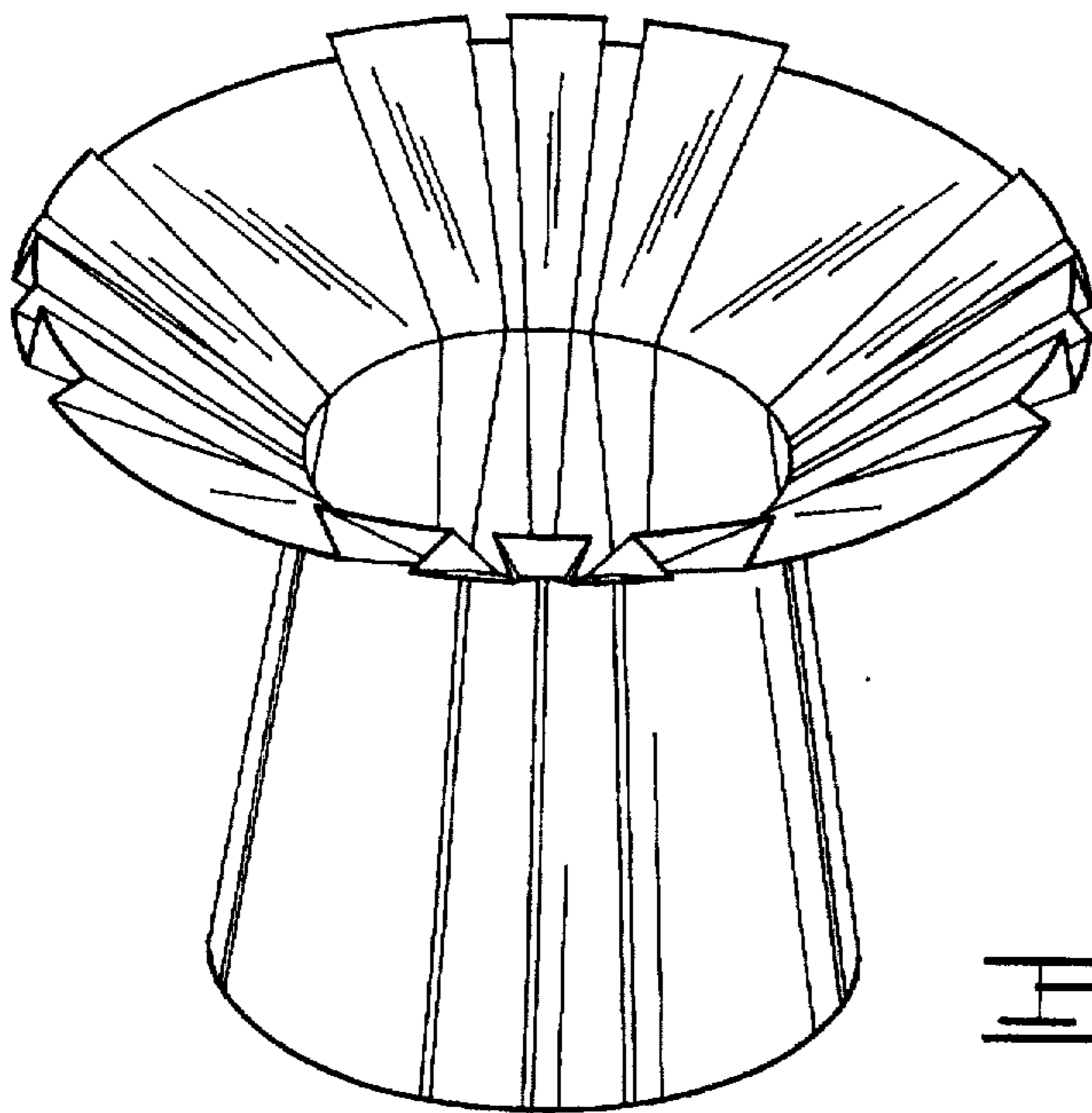

FIG. 15

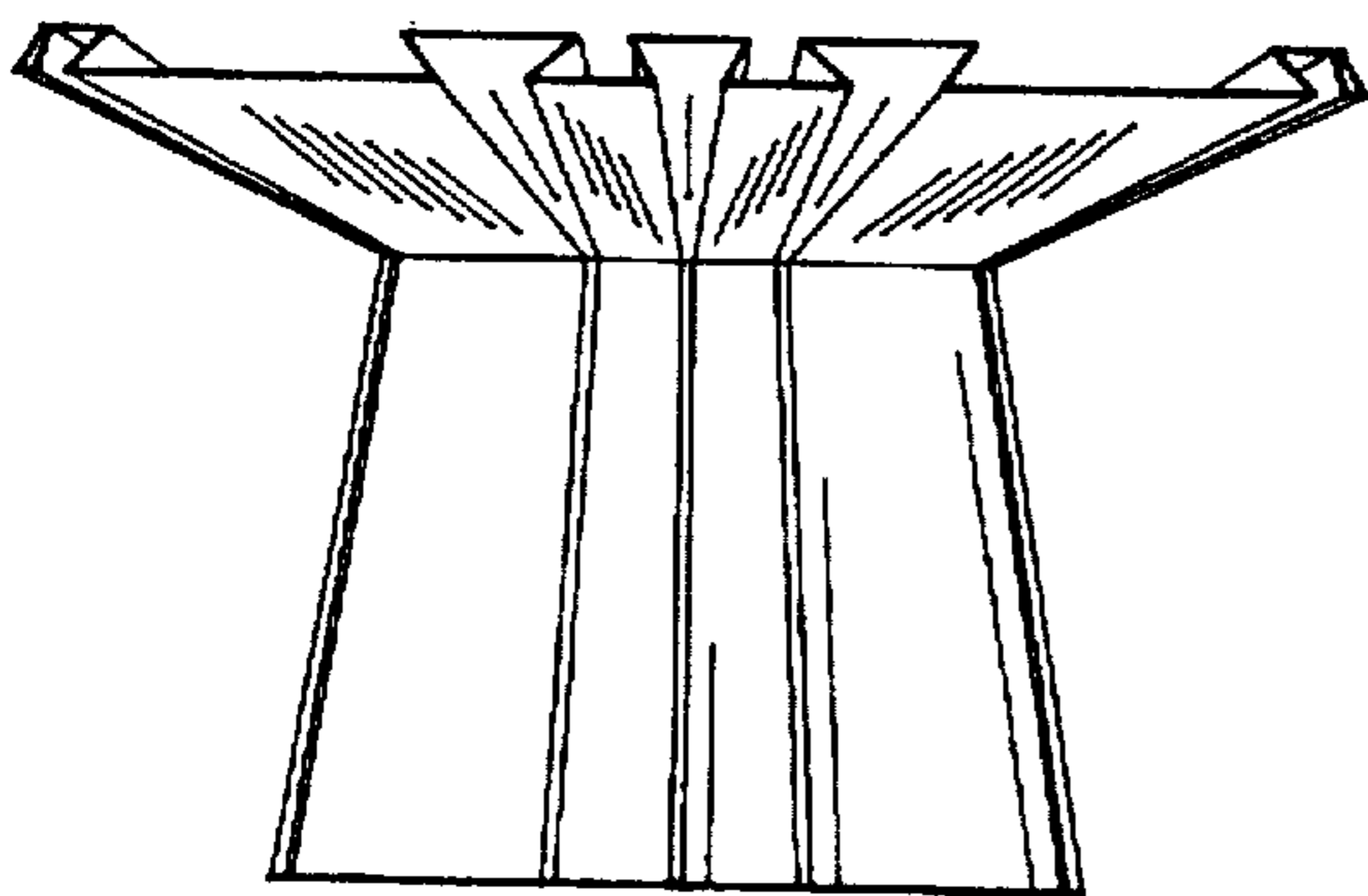

FIG. 16

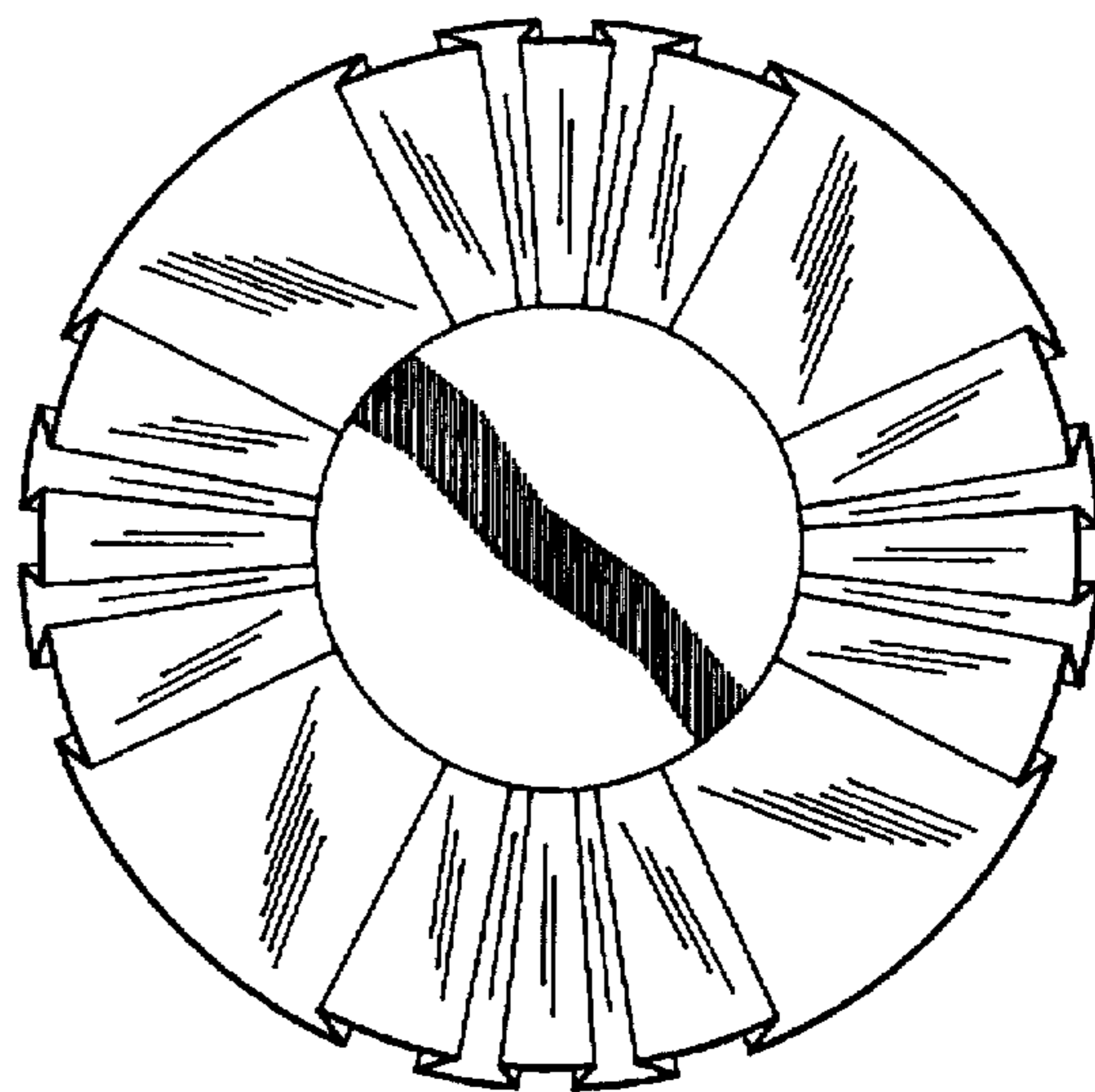

FIG. 17

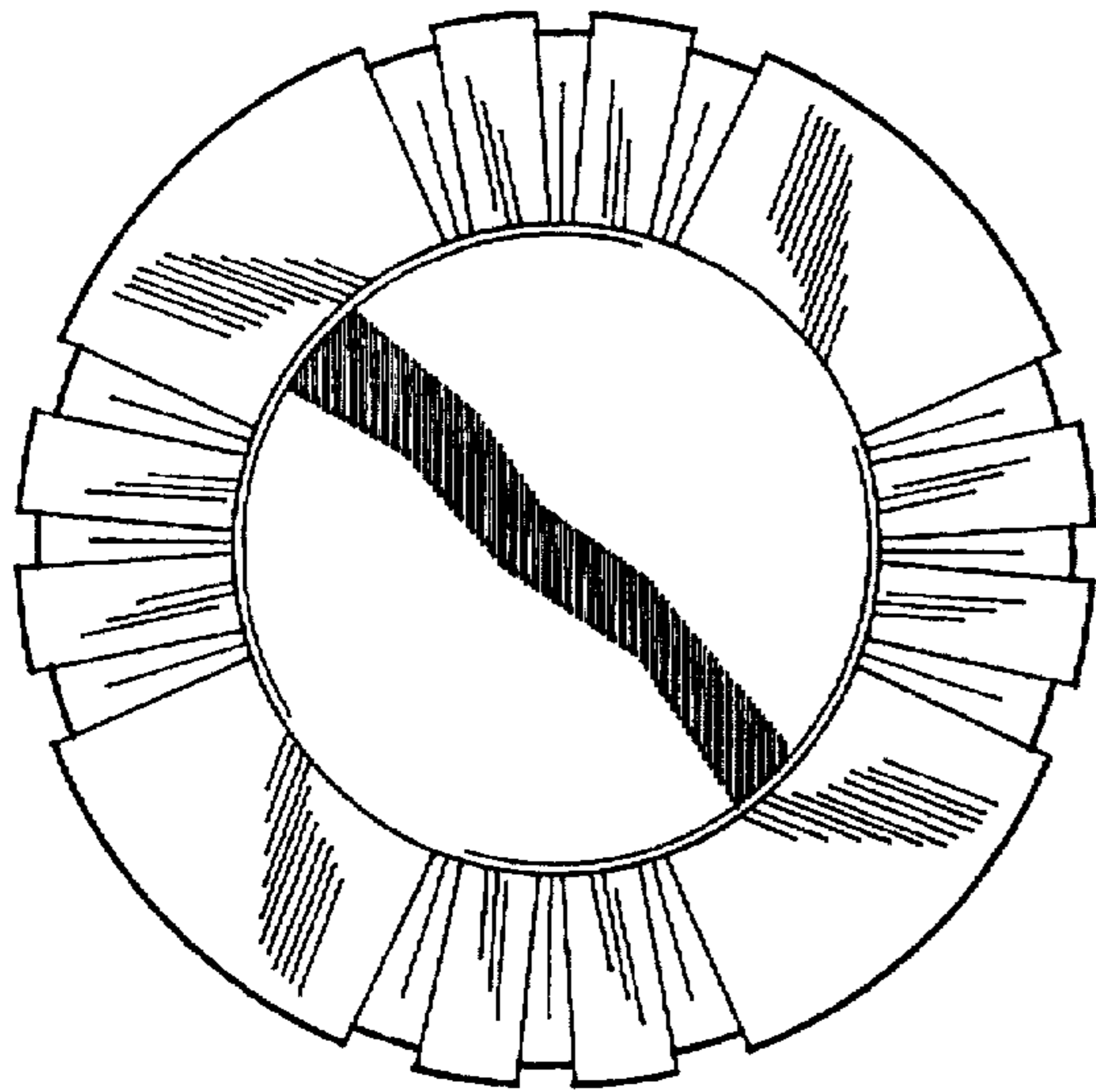

FIG. 18

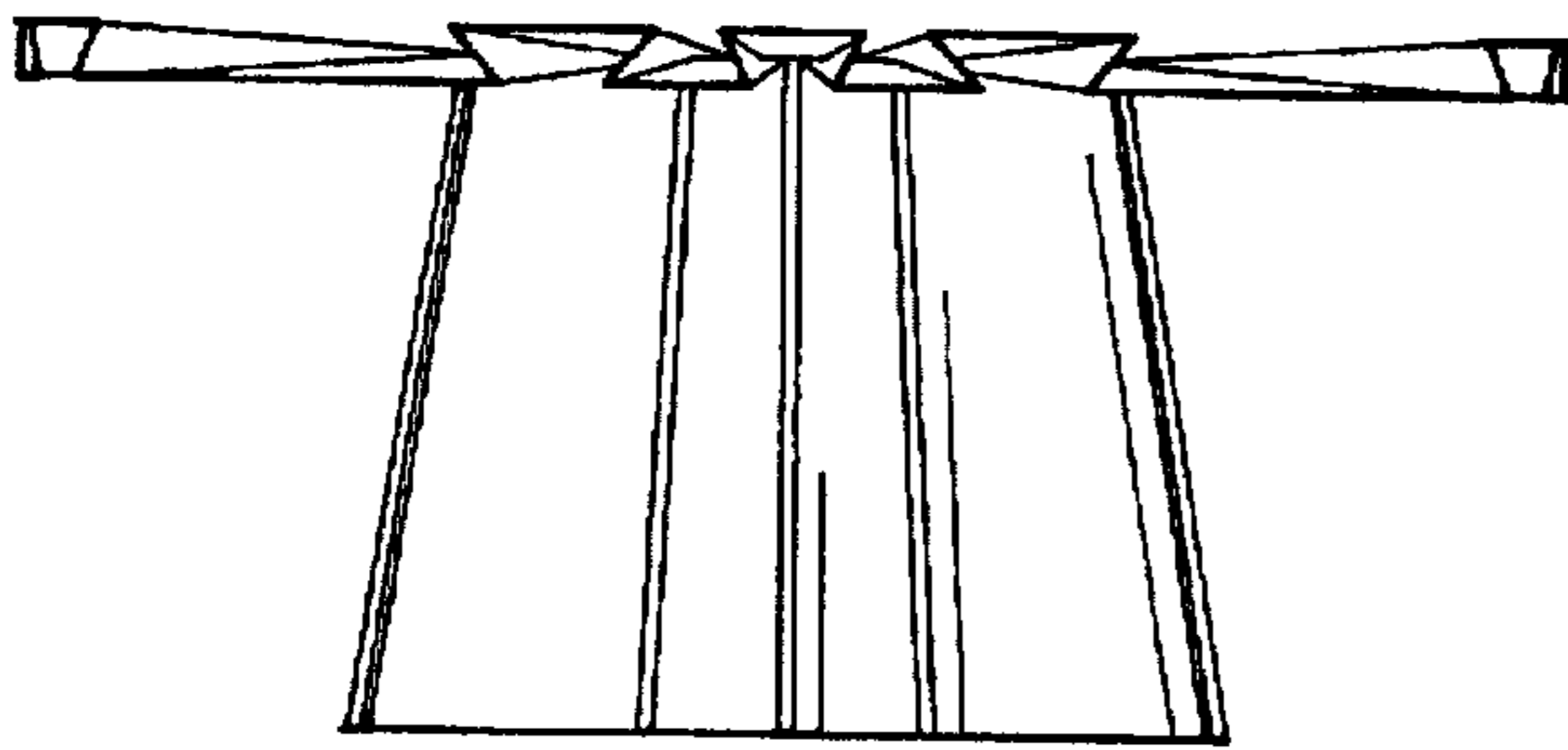

FIG. 19

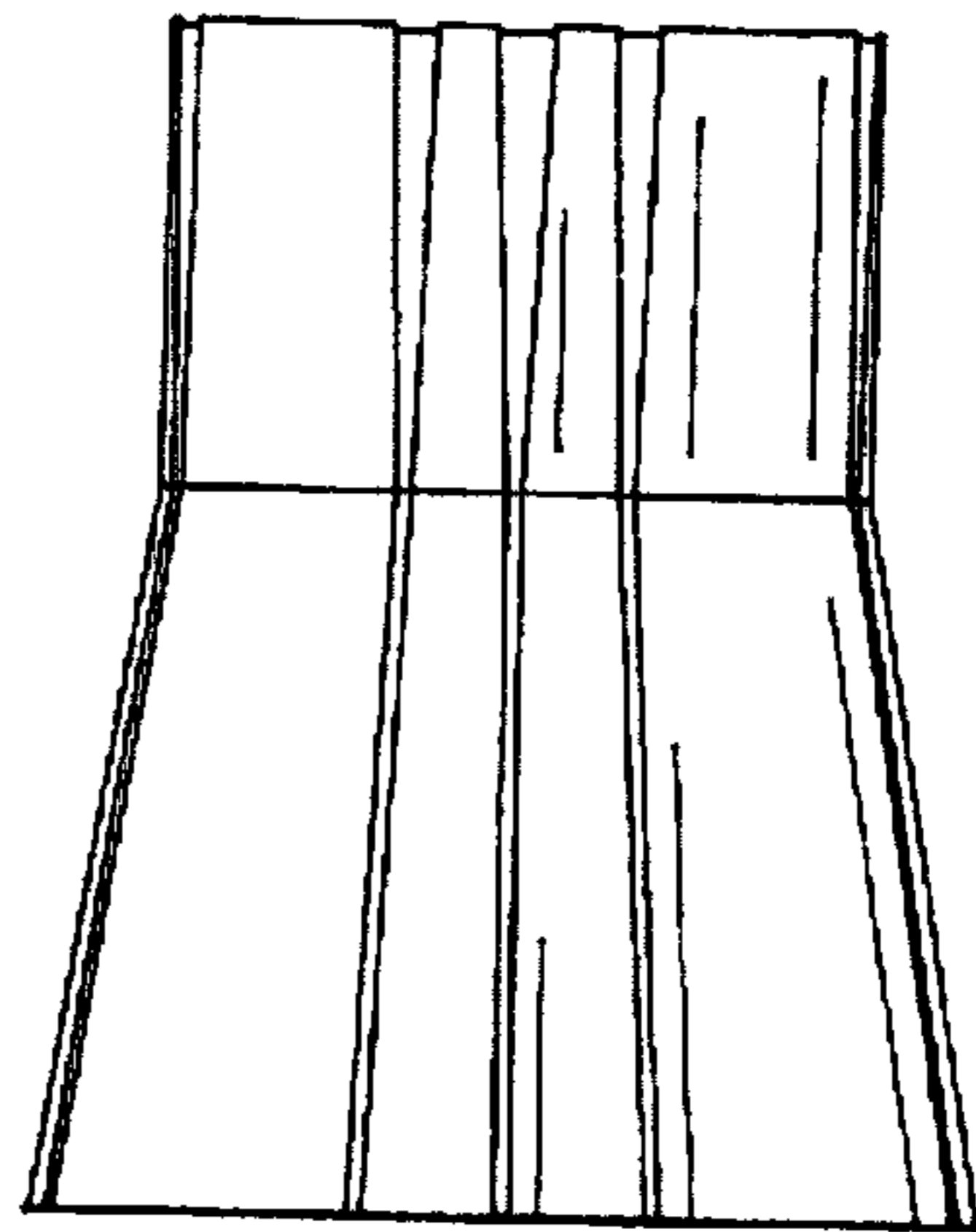

FIG. 20

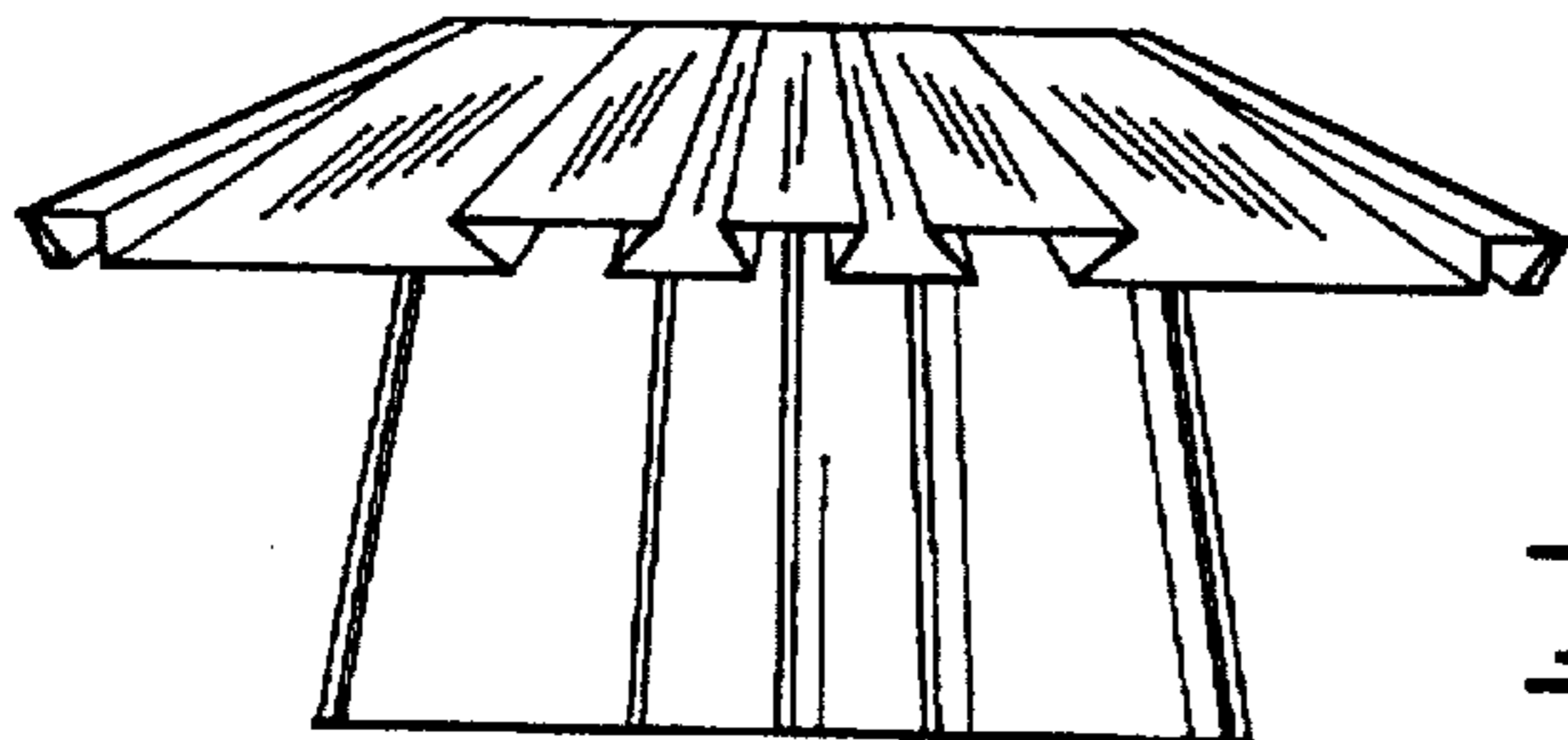

FIG. 21

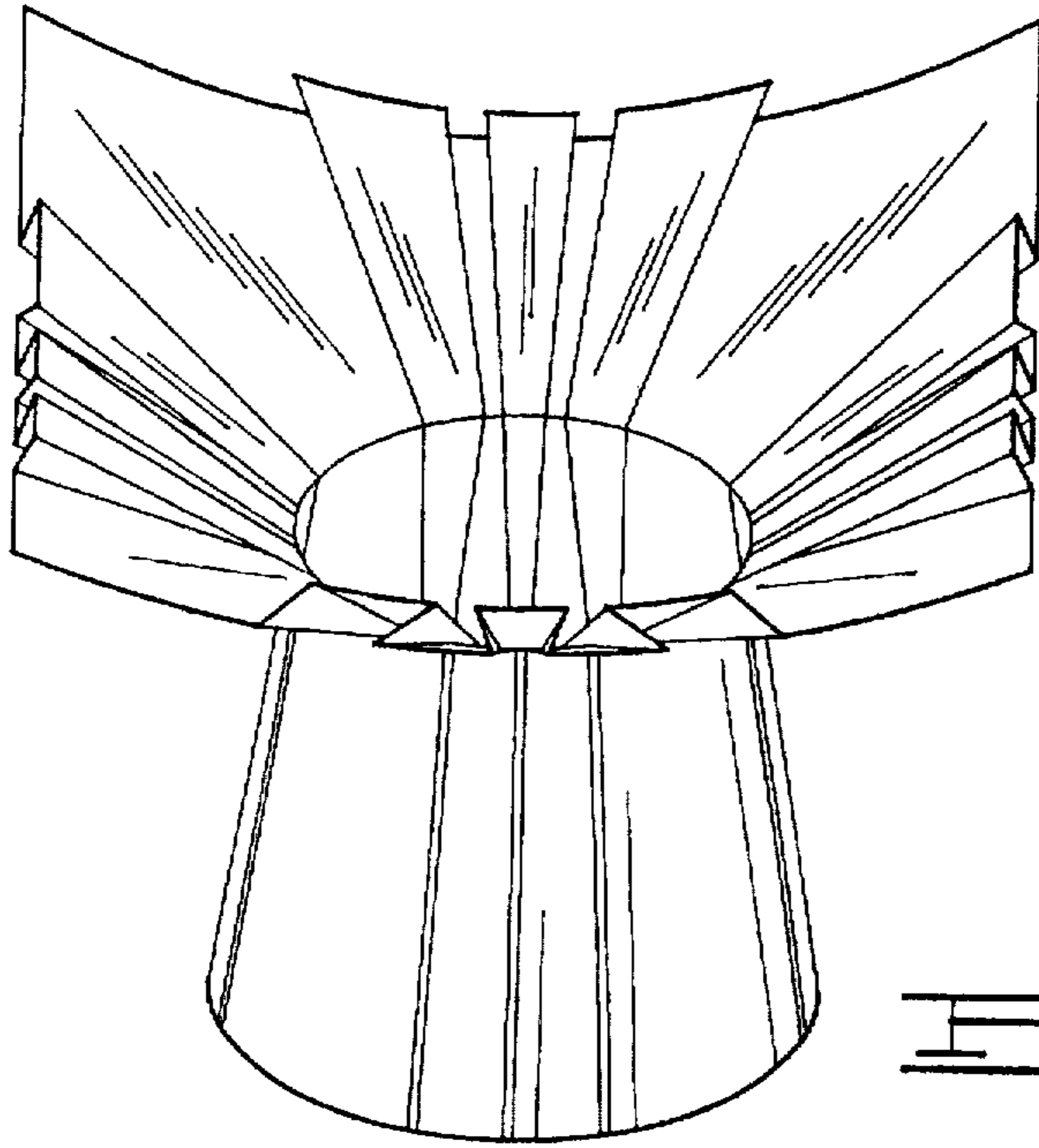

FIG. 22

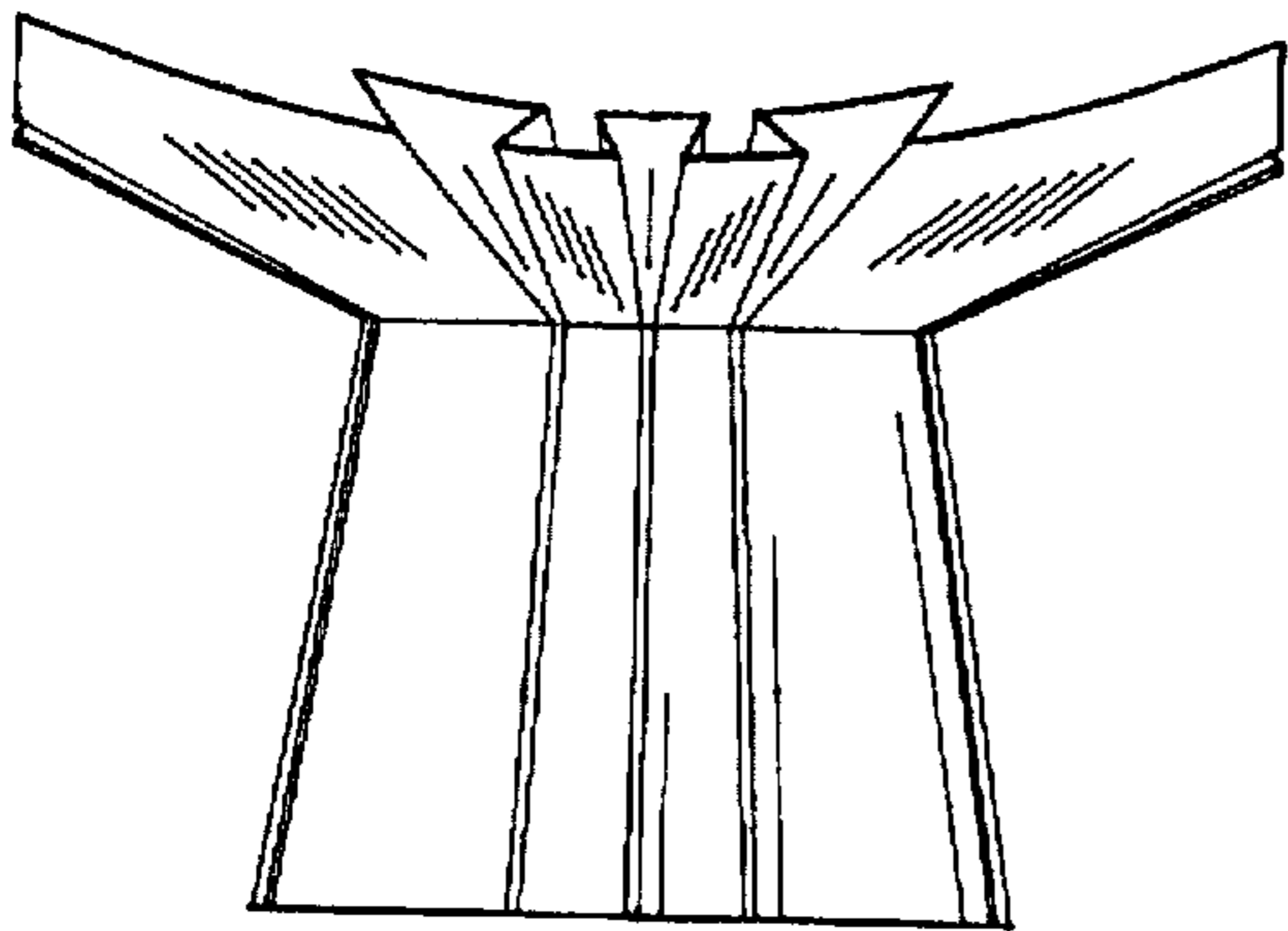

FIG. 23

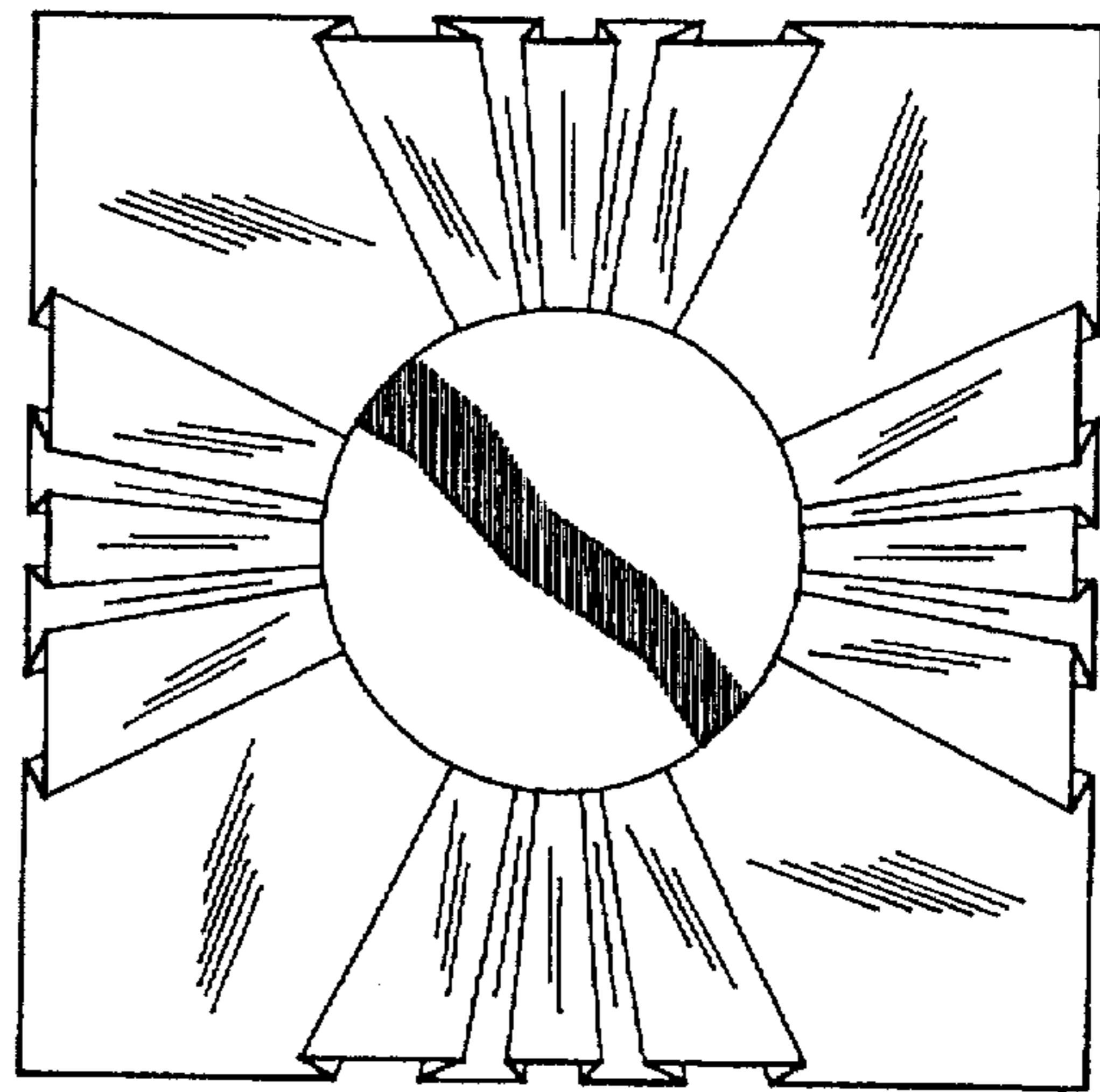

FIG. 24

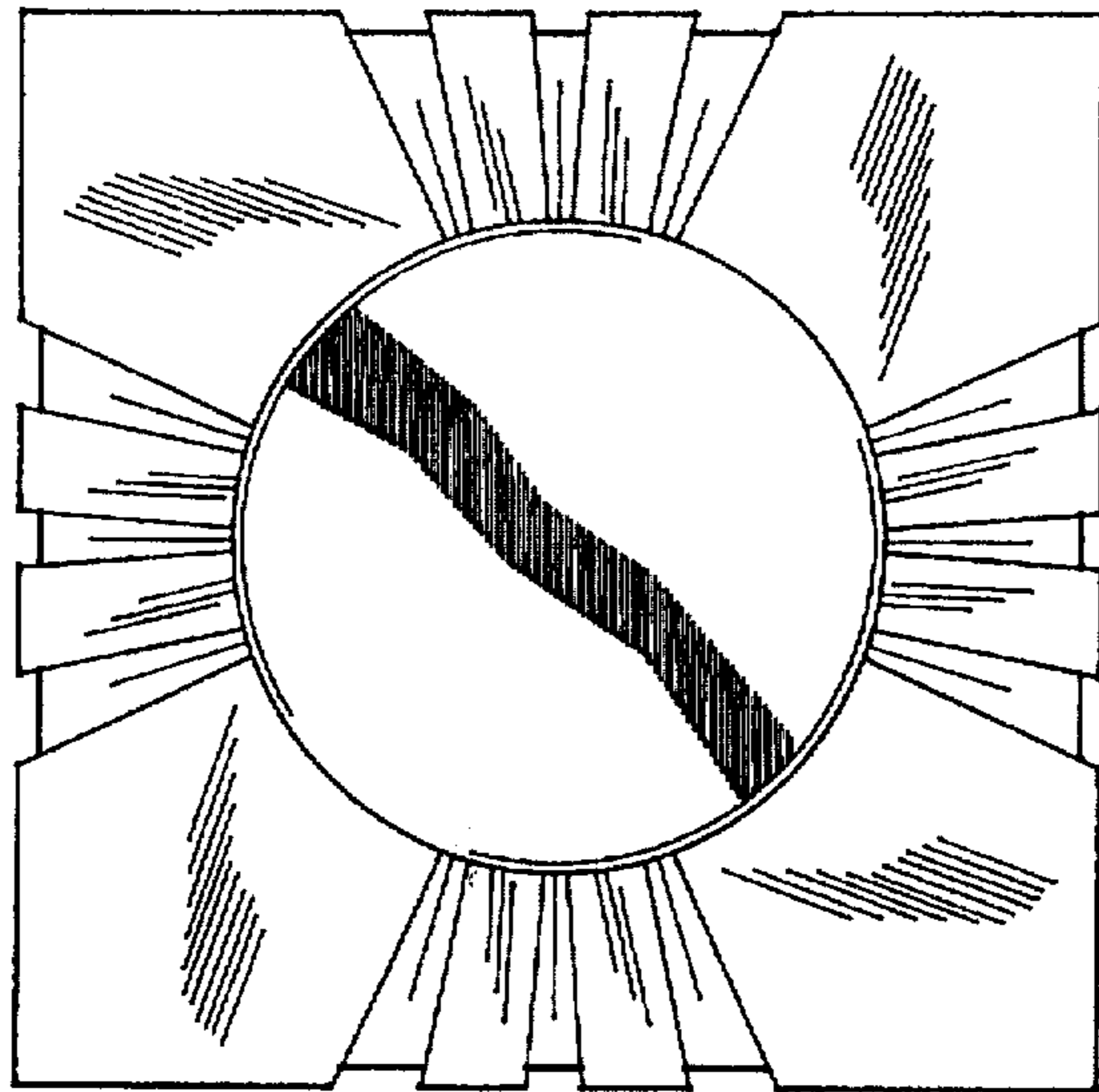

FIG. 25

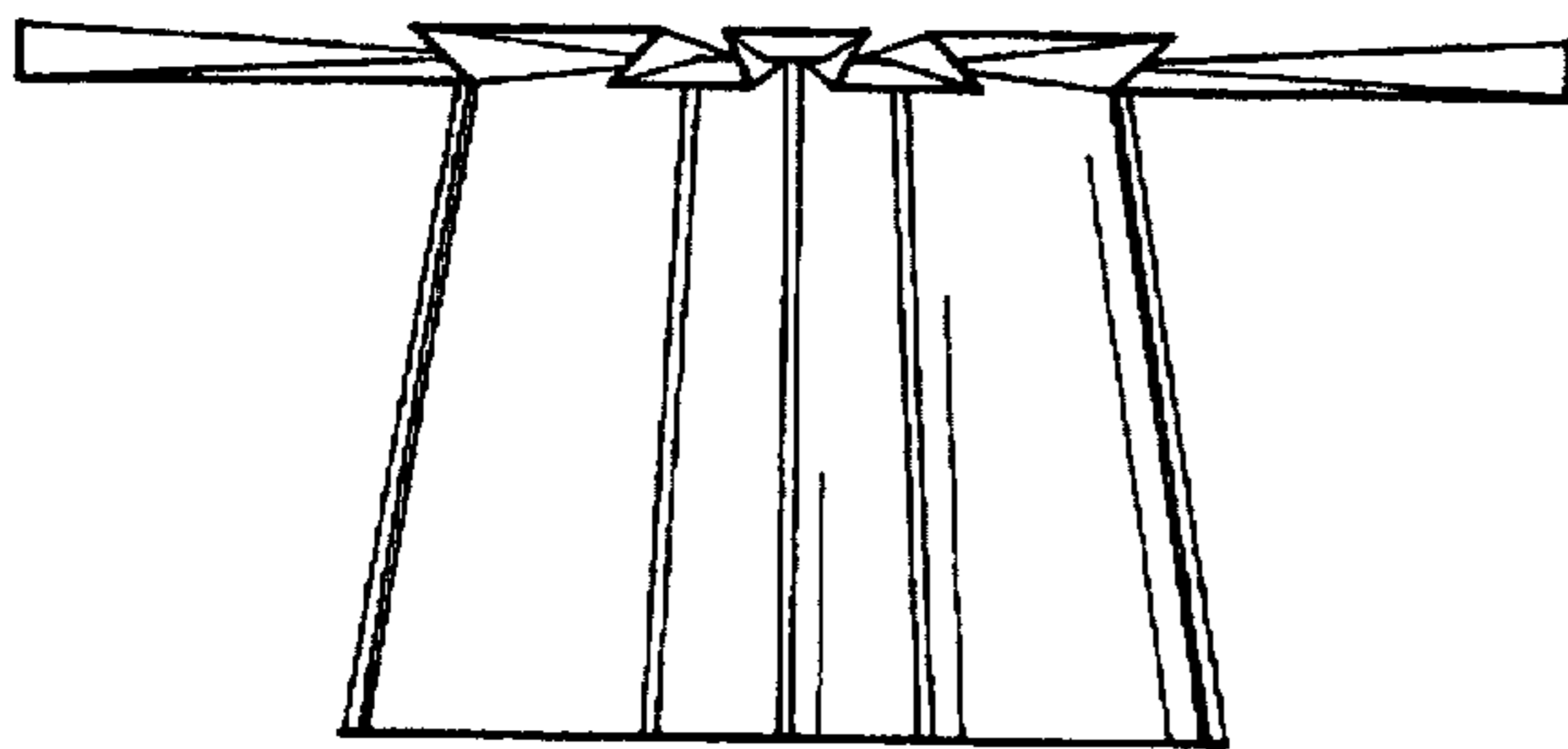

FIG. 26

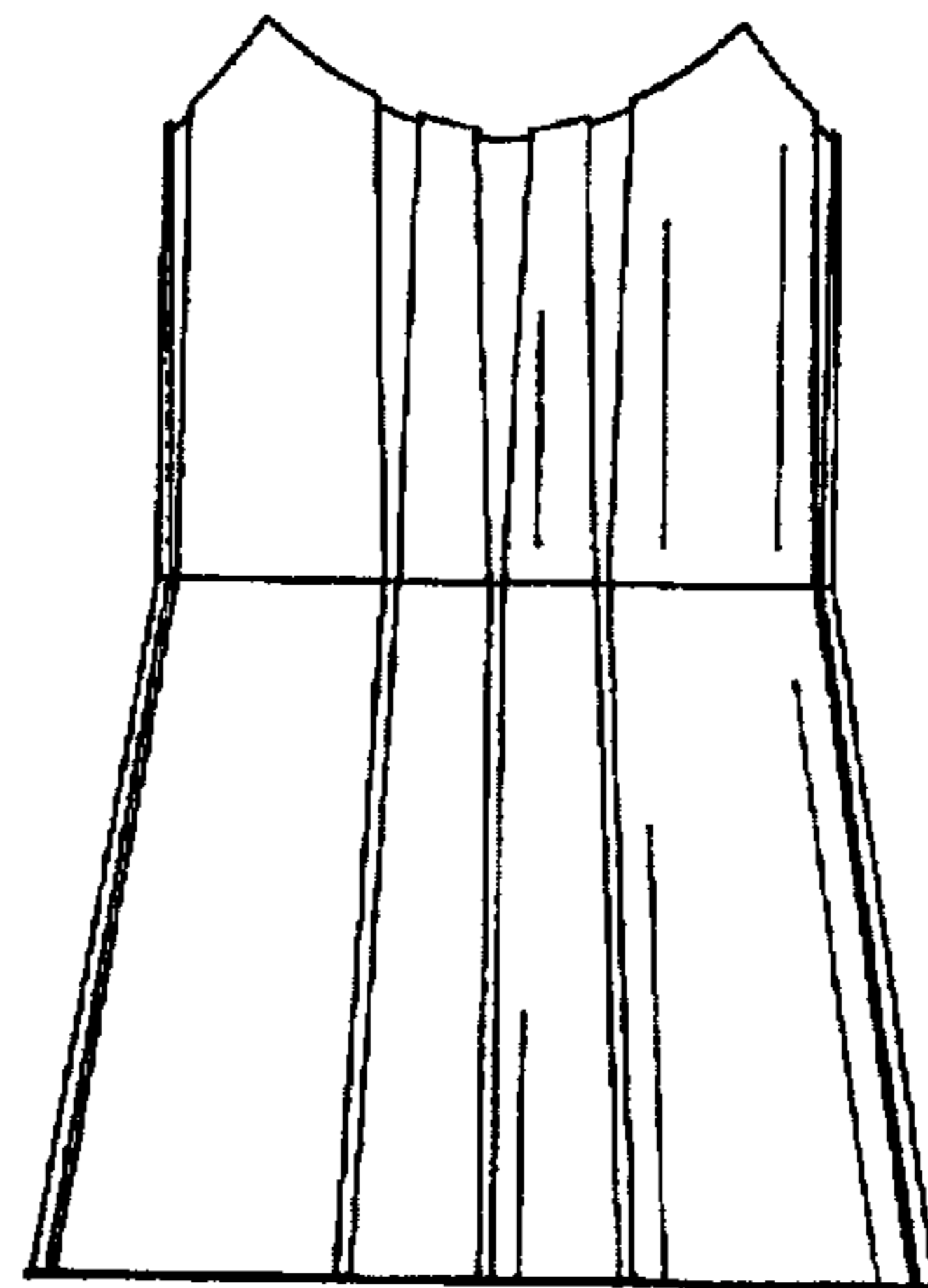

FIG. 27

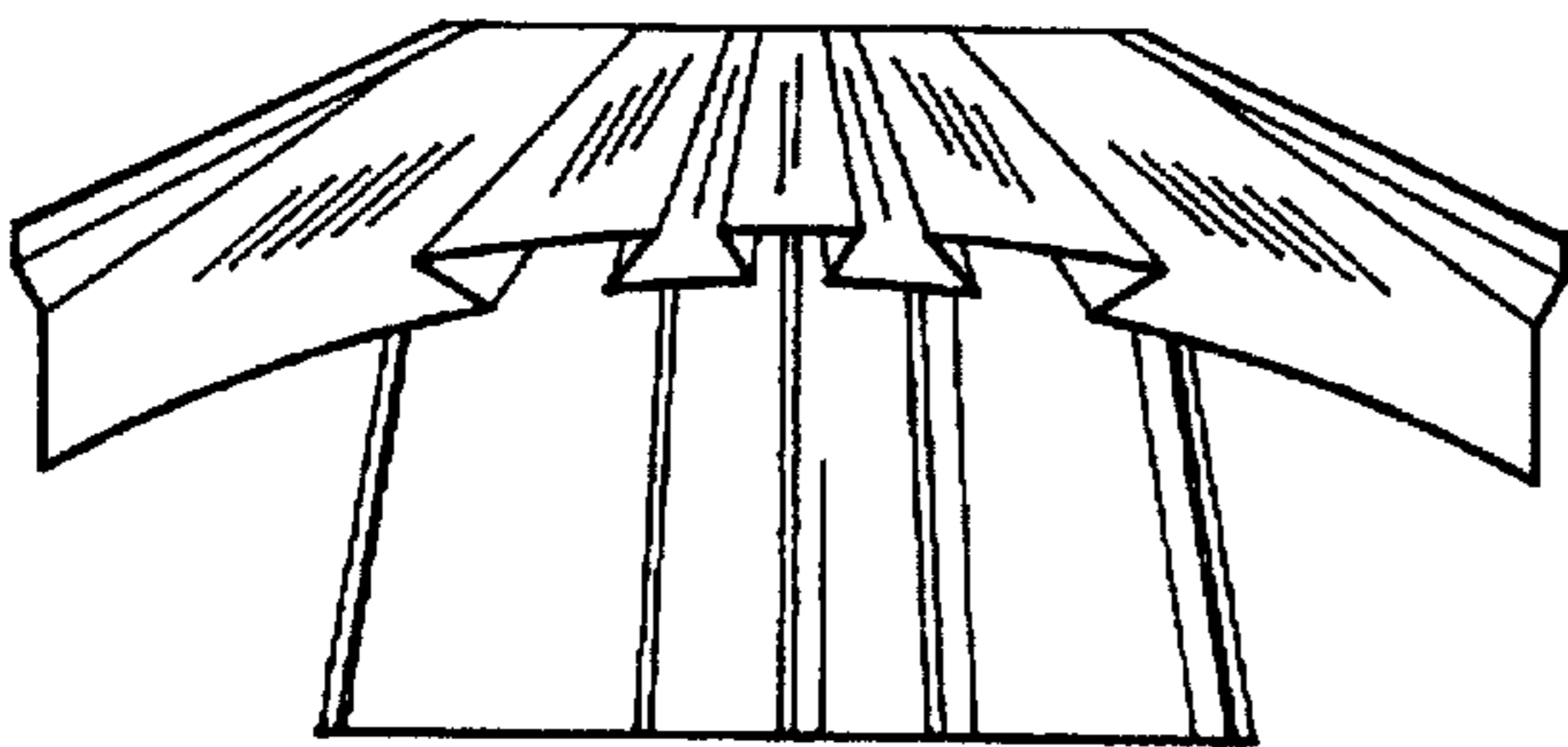

FIG. 28