

US00D386650S

# United States Patent [19]

[11] Patent Number: **Des. 386,650**

Bennett et al.

[45] Date of Patent: **\*\*Nov. 25, 1997**

[54] **BOTTLE SLEEVE**

5,269,368 12/1993 Schneider et al. .... 165/46  
5,390,804 2/1995 Beggins ..... 215/386

[75] Inventors: **Tom B. Bennett; Kevin Rausch**, both of Wooster, Ohio

### OTHER PUBLICATIONS

[73] Assignee: **Rubbermaid Specialty Products Inc.**, Wooster, Ohio

“Monongah Glass Co. Catalog”, Item No. 3531, Apr. 1920. P. 25. Bottle sleeve; Igloo Products Corp., P. O. Box 19322, Houston, Texas 77224. Publication date 1993.

[\*\*] Term: **14 Years**

Advertisement, Bottle sleeve; Soffware™, Sinclair & Rush, Inc., 13515 Barrett Parkway Drive, St. Louis, Missouri 63021-5880. Published at least as early as May, 1996.

[21] Appl. No.: **54,664**

P. 38, Bottle Sleeves; The Coleman Company, Inc., P. O. Box 2931, Wichita, Kansas 67201. Publication date 1994.

[22] Filed: **May 17, 1996**

Label, Bottle sleeve; Candea Inc., 2110 Williams Parkway, Unit 12, Brampton, Ontario, Canada L6S 5X6. Published at least as early as May, 1996.

[51] LOC (6) Cl. .... **07-06**

[52] U.S. Cl. .... **D7/624; D9/434**

[58] Field of Search ..... **D9/434, 455, 499; D7/529, 536, 619, 622, 624; 215/385, 395; 220/737, 903**

P. 59, Rapid Ice® Bottle sleeve; Chef’s Catalog, address unknown. Published at least as early as May, 1996.

Advertisement, Water Bottle sleeve; The Container Store, address unknown. Published at least as early as May, 1996.

### [56] References Cited

#### U.S. PATENT DOCUMENTS

D. 183,877	11/1958	Despres	.....	D9/434
D. 284,439	7/1986	Ventimiglia et al.	.	
D. 303,150	8/1989	Falcon	.....	D7/622 X
D. 321,457	11/1991	Kahl	.....	D7/608
D. 325,687	4/1992	Embree	.....	D7/510
D. 325,848	5/1992	Embree	.....	D7/510
D. 326,586	6/1992	Embree	.....	D7/510
D. 332,894	2/1993	Green	.....	D7/511
D. 345,105	3/1994	Ramsey	.....	D9/551
D. 347,553	6/1994	Schneider	.....	D7/603
D. 353,975	1/1995	Gooch	.....	D7/624
D. 364,781	12/1995	Fenton et al.	.....	D7/624
3,279,638	10/1966	Merry	.....	215/395
4,255,944	3/1981	Gardner	.....	62/457
4,324,111	4/1982	Edwards	.....	62/457
4,338,795	7/1982	House	.....	62/372
4,344,303	8/1982	Kelly	.....	62/530
4,393,975	7/1983	Moore	.....	206/385
4,413,481	11/1983	Thomas	.....	62/371
4,653,290	3/1987	Byrne	.....	62/372
4,831,842	5/1989	Kelley et al.	.....	62/457.4
4,882,914	11/1989	Haines-Keeley	.....	62/457.4
4,908,248	3/1990	Nakashima et al.	.....	428/355
4,932,225	6/1990	Bighouse	.....	62/457.4
4,986,089	1/1991	Raab	.....	62/457.4
4,989,418	2/1991	Hewlett	.....	62/457.4
5,067,922	11/1991	McMahon	.....	446/71
5,188,877	2/1993	Magaro	.....	428/80

P. 2, Bottle sleeves; Rubbermaid Incorporated, Specialty Products Division, 1147 Akron Road, Wooster, Ohio 44691. Publication date 1991.

P. 55, Sleeves for bottles; The Coleman Company, Inc., P. O. Box 2931, Wichita, Kansas 67201. Publication date 1994.

*Primary Examiner*—James Gandy

*Assistant Examiner*—Cathron B. Matta

*Attorney, Agent, or Firm*—Richard B. O’Planick; Lisa B. Riedesel

### [57] CLAIM

The ornamental design for a bottle sleeve, as shown and described.

### DESCRIPTION

FIG. 1 is a top left front perspective view of a bottle sleeve showing our new design;

FIG. 2 is a left side elevational view thereof;

FIG. 3 is a bottom plan view thereof;

FIG. 4 is a rear elevational view thereof;

FIG. 5 is a right side elevational view thereof;

FIG. 6 is a front elevational view thereof; and,

FIG. 7 is a top plan view thereof.

**1 Claim, 7 Drawing Sheets**

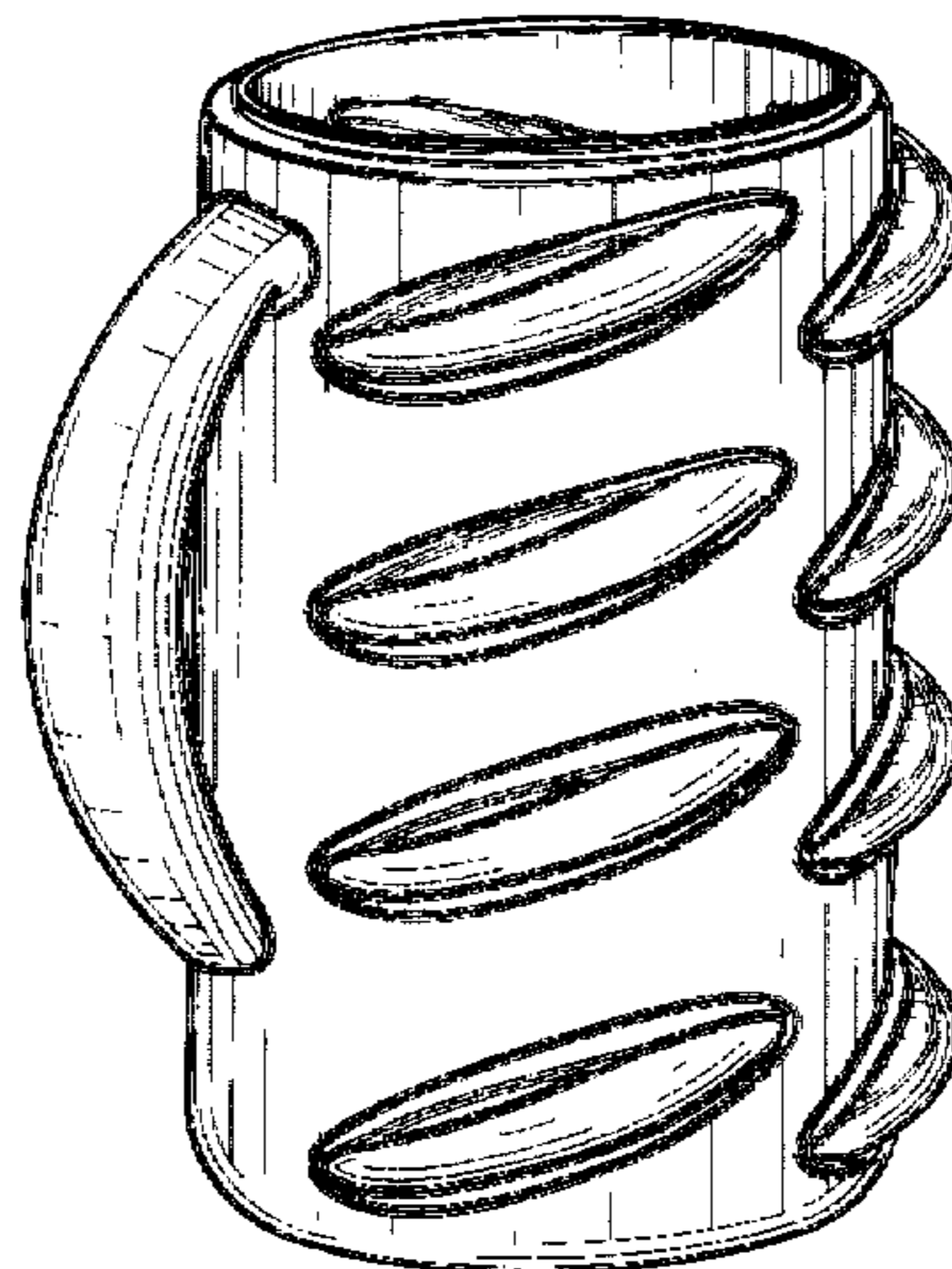

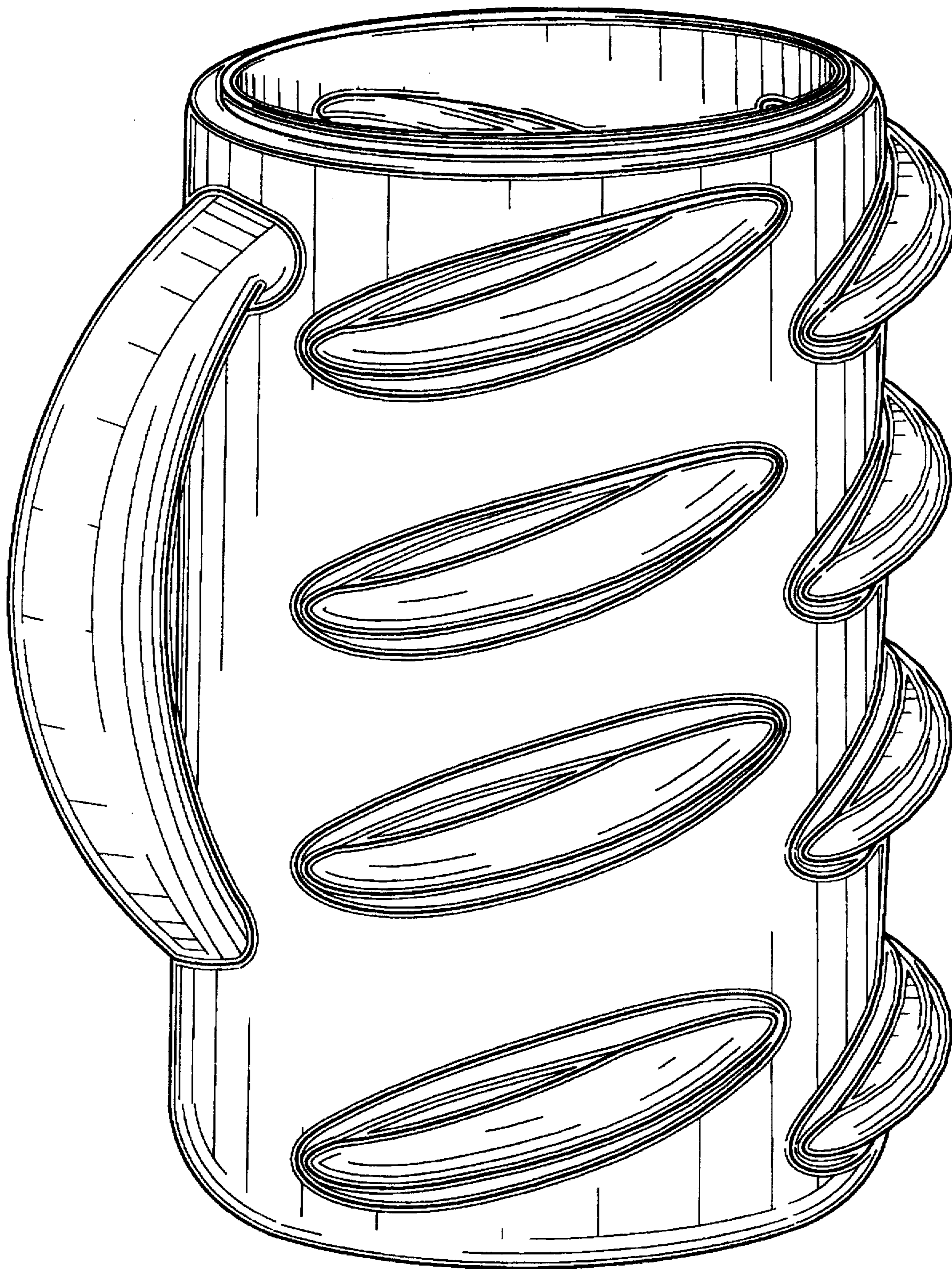

FIG. 1

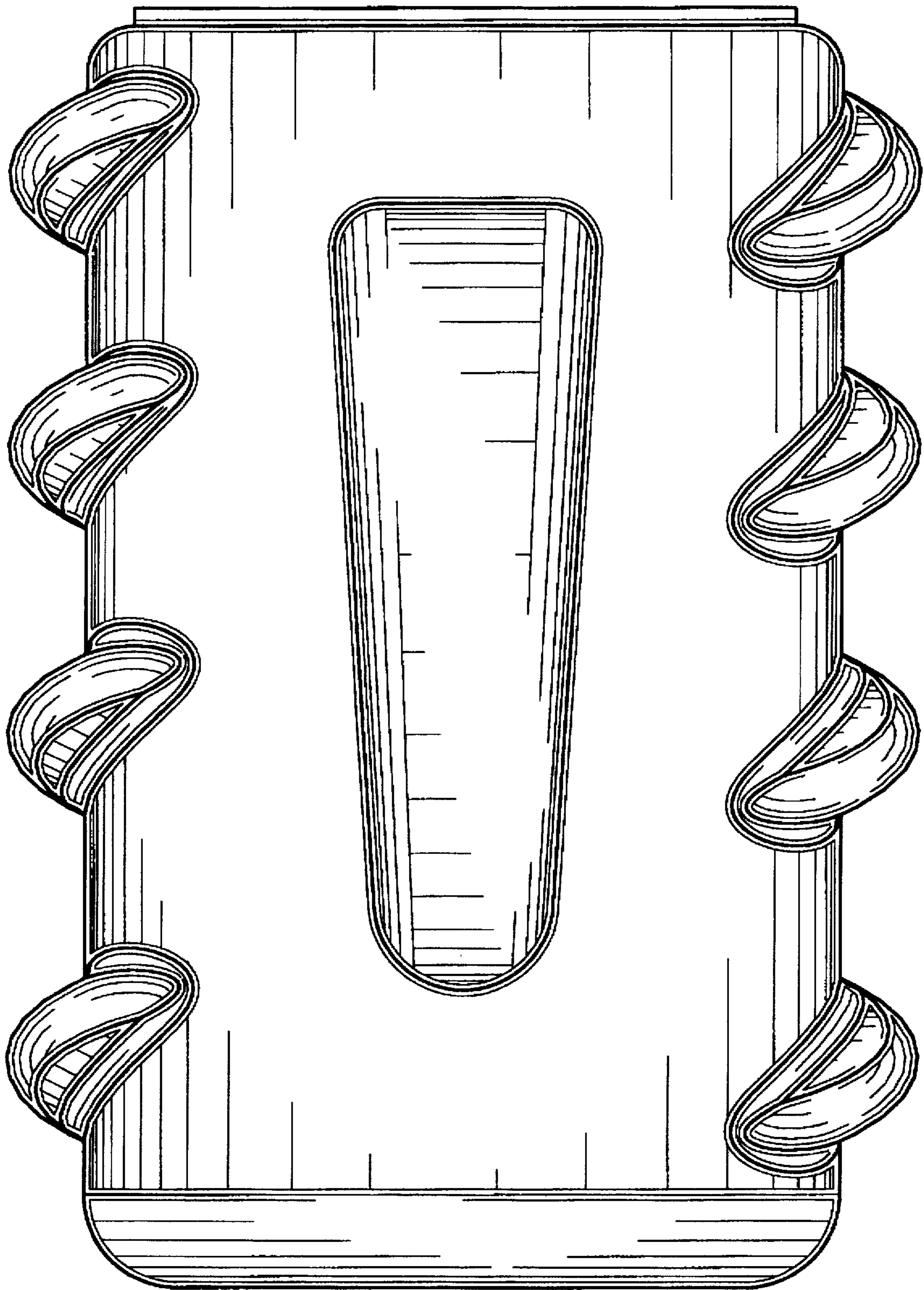

FIG. 2

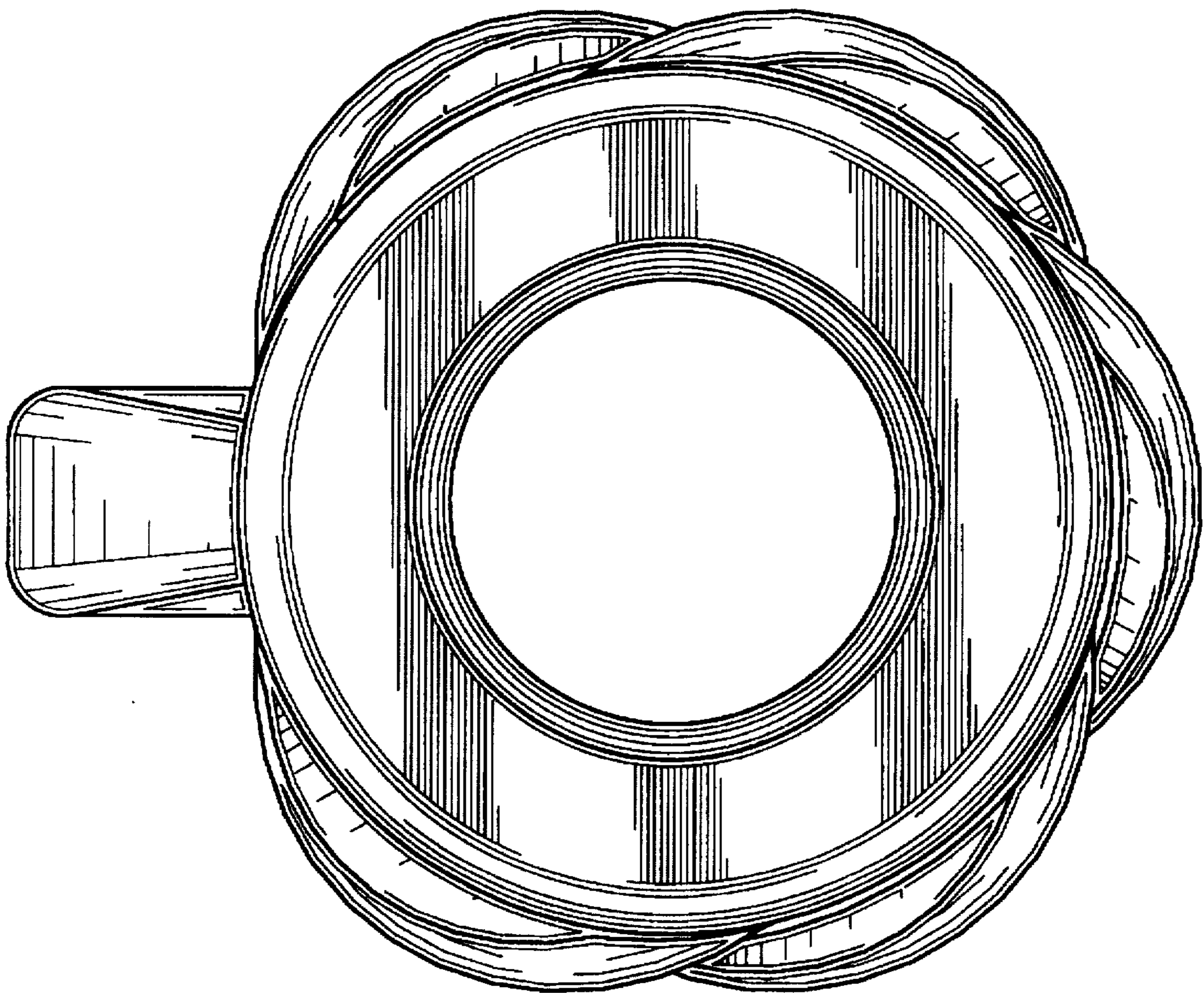

FIG. 3

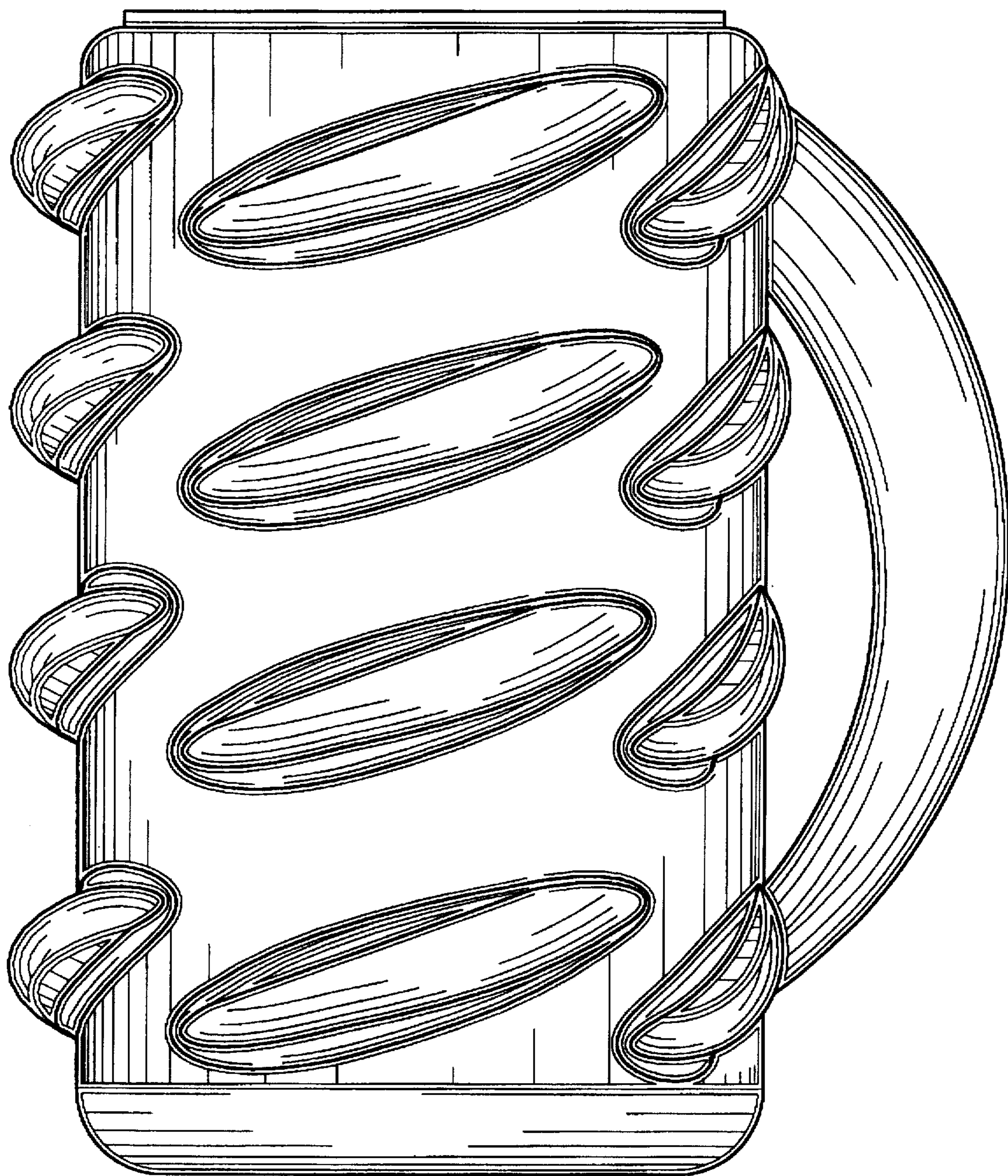

FIG. 4

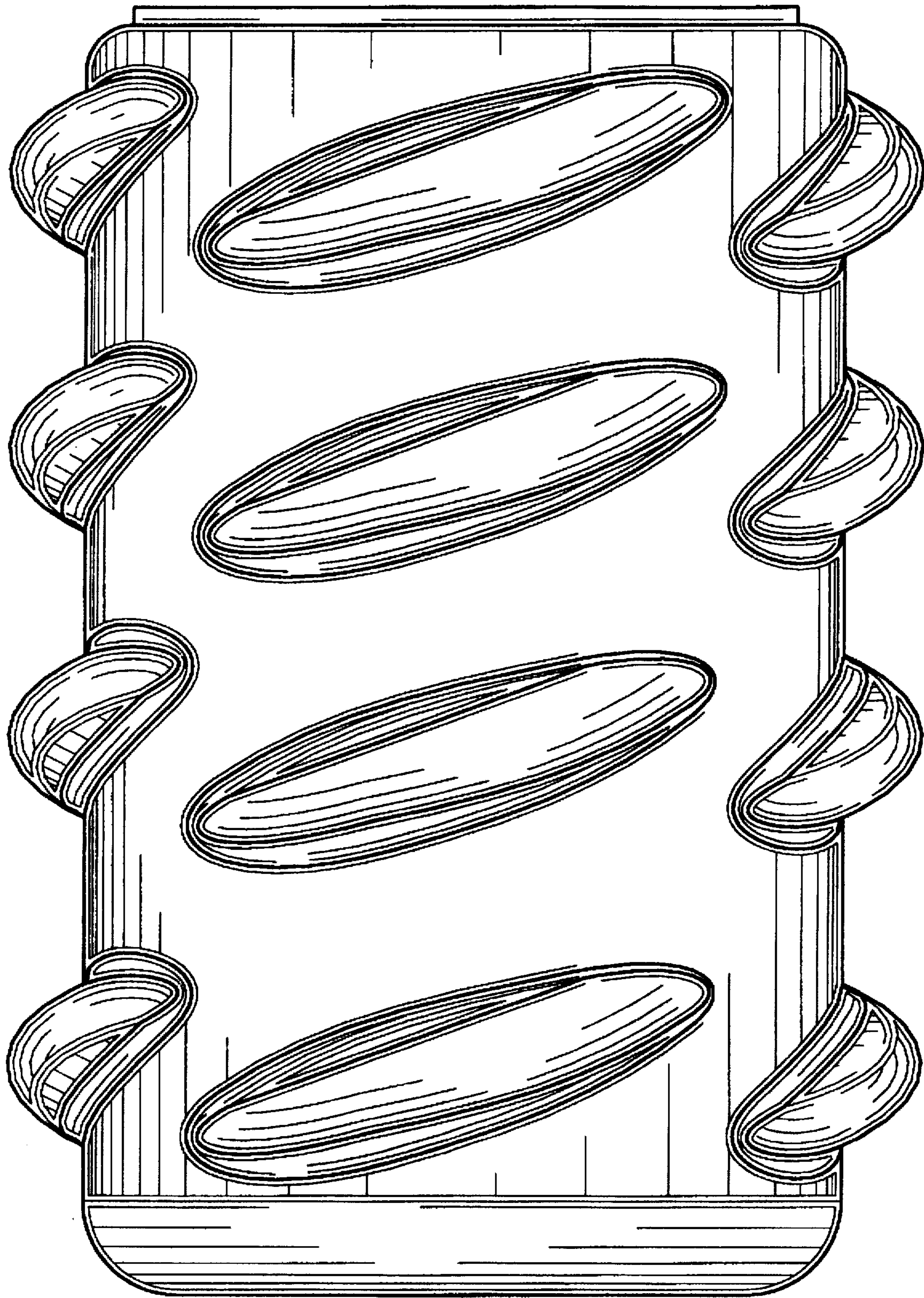

FIG. 5

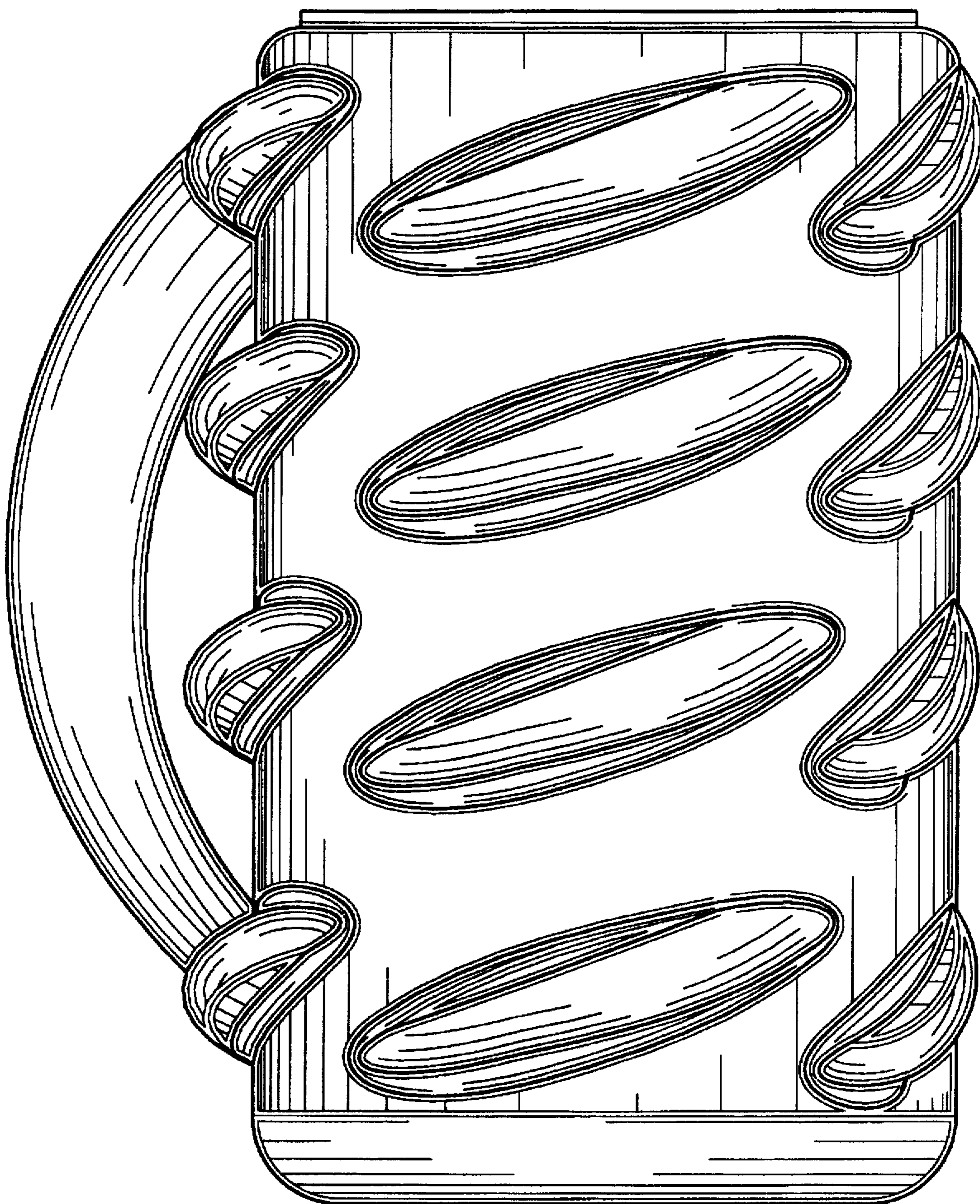

FIG. 6

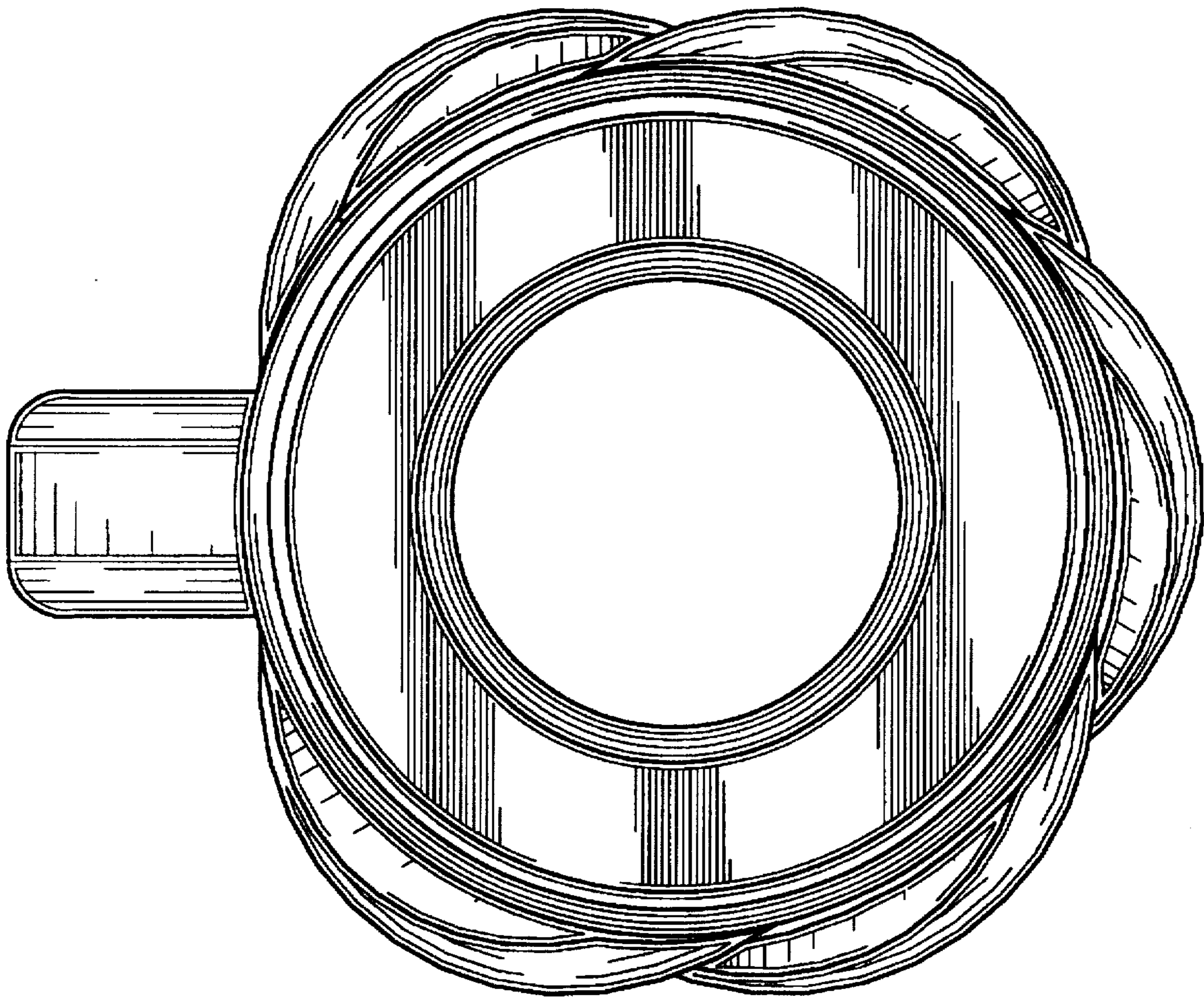

FIG. 7