



US00D386617S

United States Patent [19]

[11] Patent Number: **Des. 386,617**

Shyu

[45] Date of Patent: ****Nov. 25, 1997**

[54] **Y-SHAPED TOOTHBRUSH**

[76] Inventor: **Jenq-Pyng Shyu**, 26231 Carmel St., Laguna Hills, Calif. 92656

[**] Term: **14 Years**

[21] Appl. No.: **38,423**

[22] Filed: **May 5, 1995**

Related U.S. Application Data

[63] Continuation-in-part of Ser. No. 27,629, Aug. 25, 1994, abandoned.

[51] LOC (6) Cl. **04-02**

[52] U.S. Cl. **D4/104; D28/64**

[58] Field of Search **D4/104-112, 129, D4/132-134, 138; D28/64; 15/143.1, 159.1, 160, 167.1, 167.2; 132/308, 309, 323, 324, 326**

[56] References Cited

U.S. PATENT DOCUMENTS

D. 111,170	9/1938	Brown	D4/129
D. 289,230	4/1987	DeMartino	D4/110
D. 301,770	6/1989	Bethany	D28/64
1,507,500	9/1924	Metz	15/167.1
1,643,217	9/1927	Lazarus	15/167.1 X
1,667,134	4/1928	Sherwood	132/323
2,607,358	8/1952	Maas	132/326
3,163,874	1/1965	Bauer	15/160
3,672,377	6/1972	Greenacre	15/176.6
5,127,415	7/1992	Preciutti	132/323

FOREIGN PATENT DOCUMENTS

9205722	4/1992	WIPO	15/167.1
---------	--------	------	-------	----------

Primary Examiner—Alan P. Douglas

Assistant Examiner—Lavone D. Tabor

Attorney, Agent, or Firm—Gene Scott; Patent Law & Venture Group

[57] CLAIM

The ornamental design for a “y-shaped toothbrush”, as shown and described.

DESCRIPTION

FIG. 1 is a perspective view of a first embodiment of the present invention, showing my new design;

FIG. 2 is a top plan view thereof;

FIG. 3 is a bottom plan view thereof;

FIG. 4 is a right side elevational view thereof, the left side elevation view being a mirror image thereof;

FIG. 5 is a front elevational view thereof;

FIG. 6 is a rear elevational view thereof;

FIG. 7 is a perspective view of a second embodiment of the design shown in FIGS. 1-6, the only difference residing in the omission of cylindrical sleeves on the branched portions or fingers;

FIG. 8 is a perspective view of a third embodiment of the design shown in FIGS. 1-6, the only difference residing in the appearance of the head, the extending fingers thereof being more parallel than in the first embodiment, and the conformation of the tips of the extending fingers being rounded instead of squared-off;

FIG. 9 is a top plan view of FIG. 8;

FIG. 10 is a bottom plan view of FIG. 8;

FIG. 11 is a right side elevational view of FIG. 8, the left side elevation view being a mirror image thereof;

FIG. 12 is a front elevational view of FIG. 8; and,

FIG. 13 is a rear elevational view of FIG. 8.

1 Claim, 7 Drawing Sheets

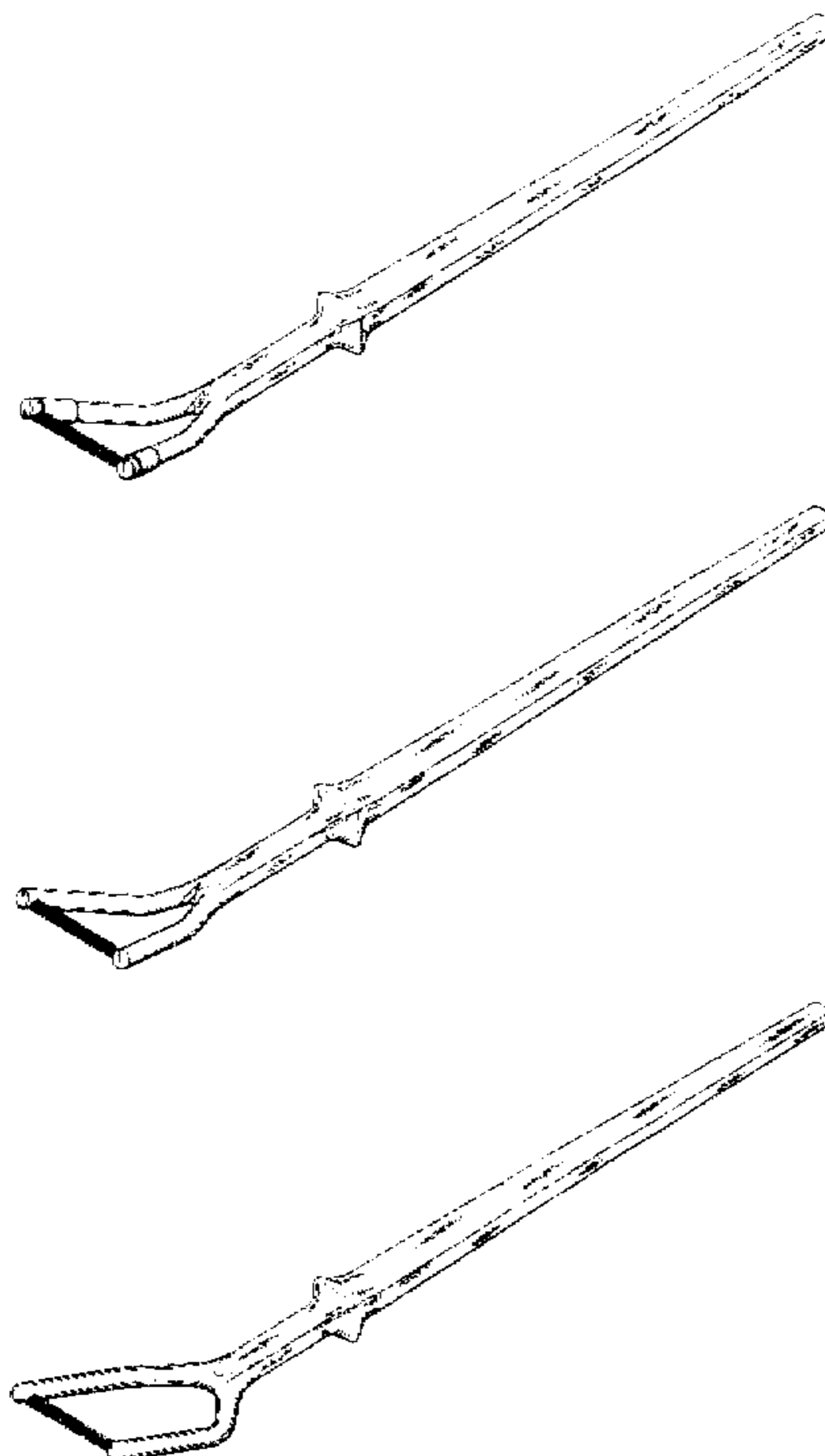

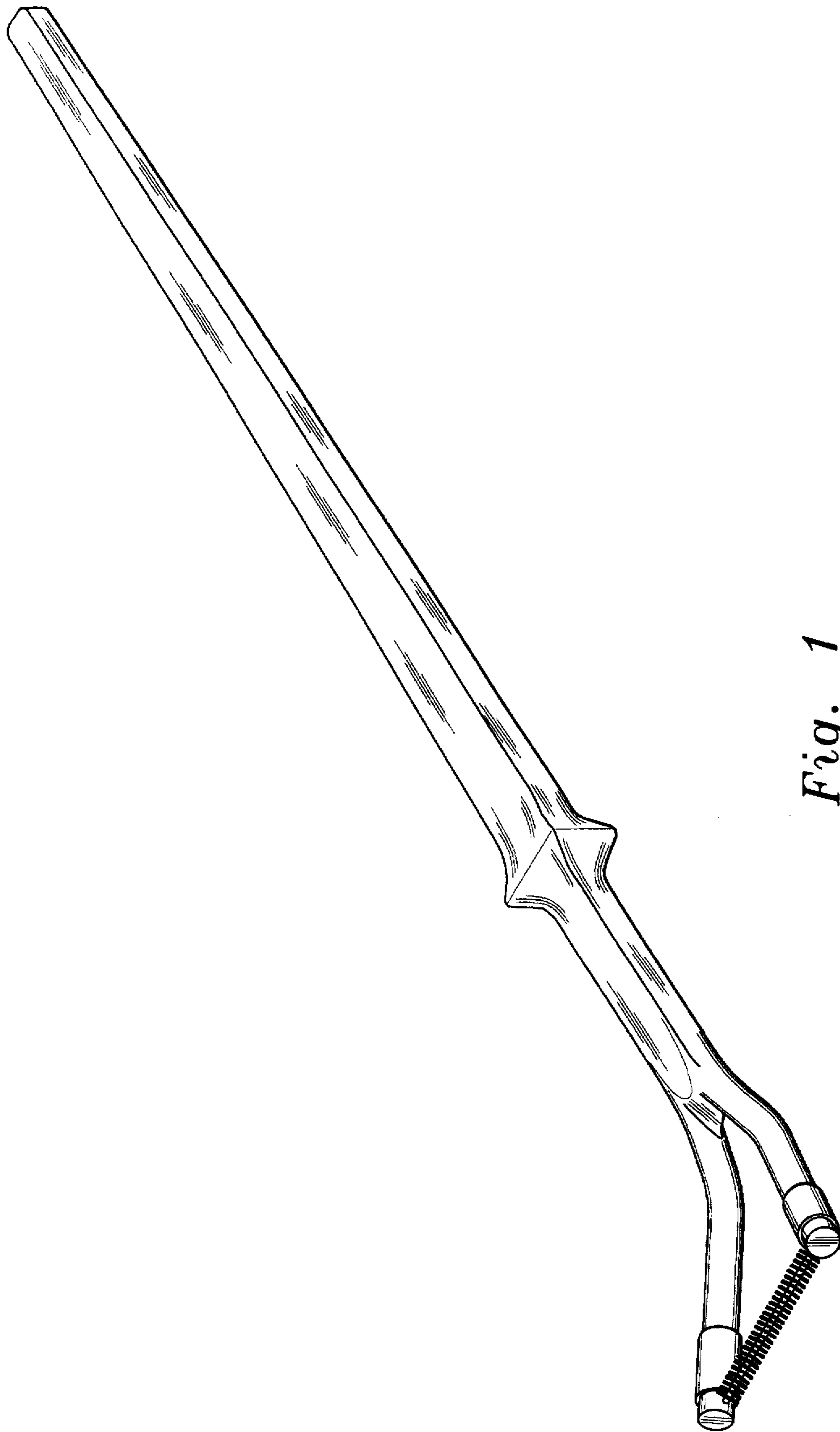

Fig. 1

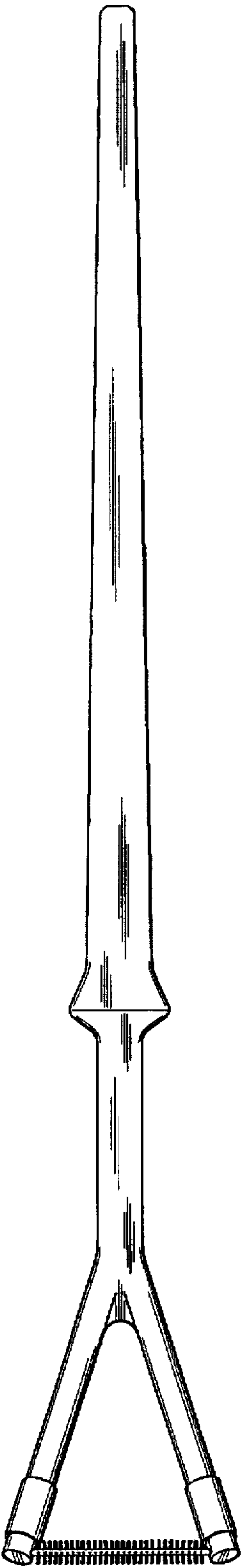

FIG 2

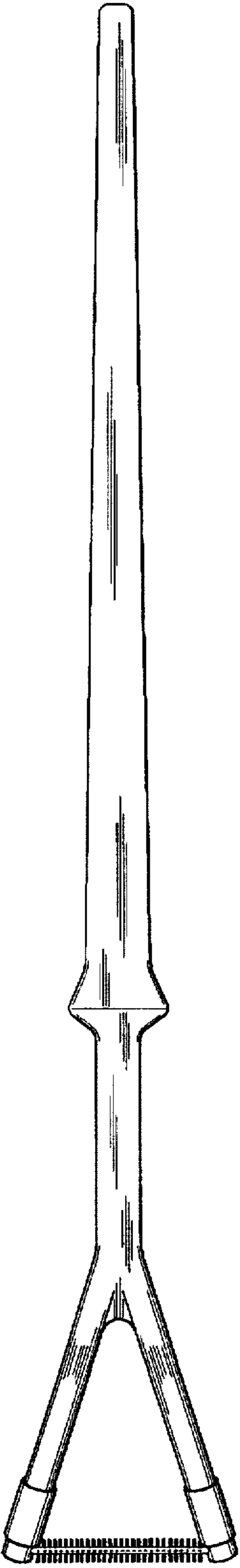

FIG 3

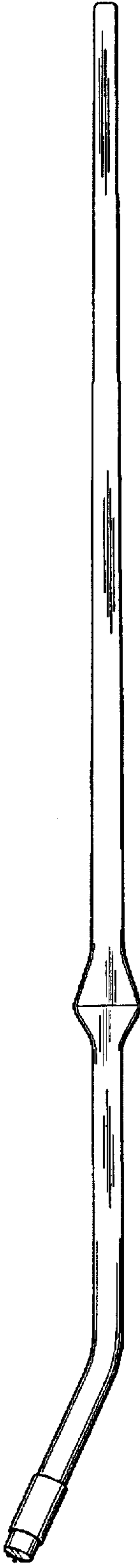

FIG 4

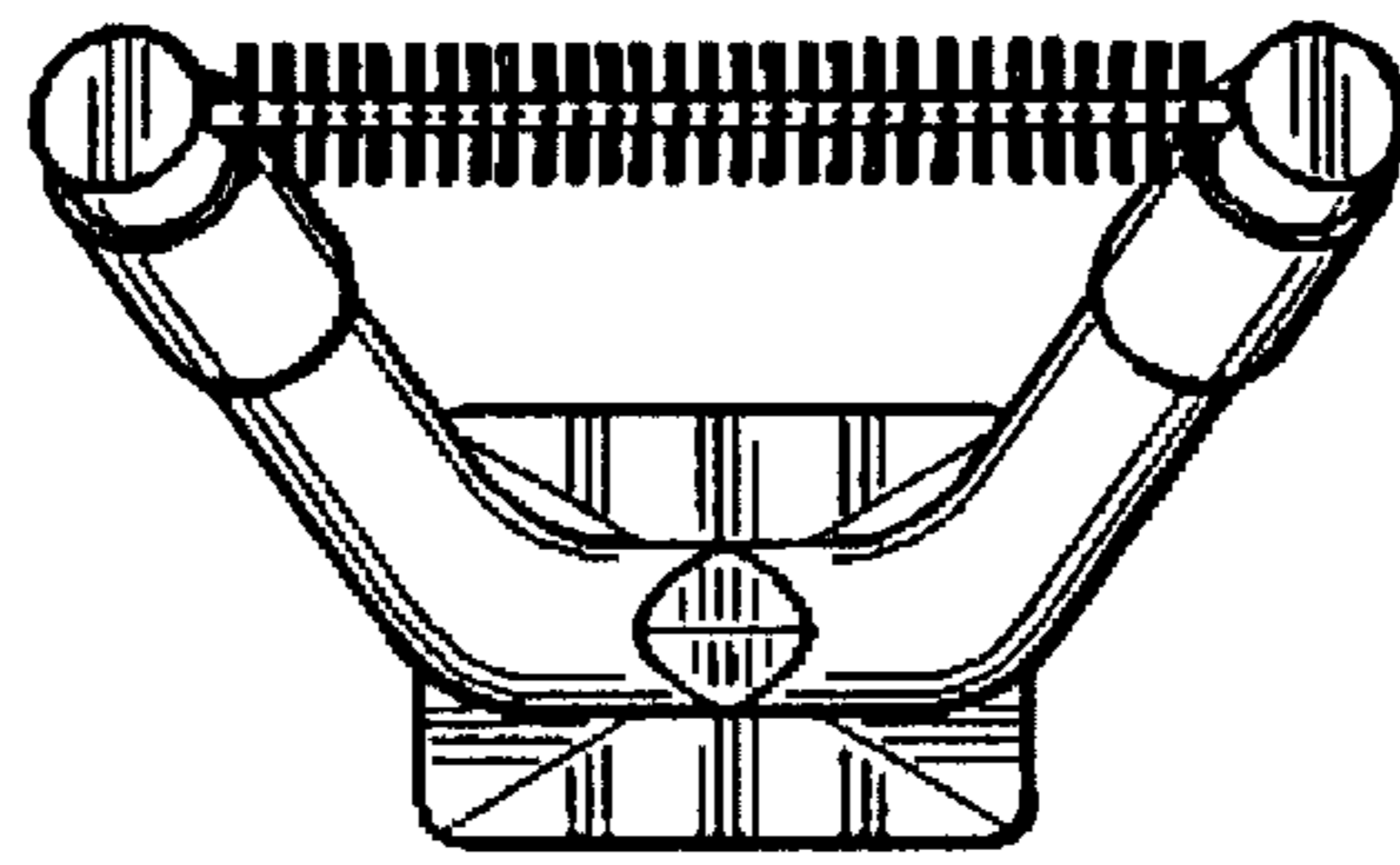

FIG 5

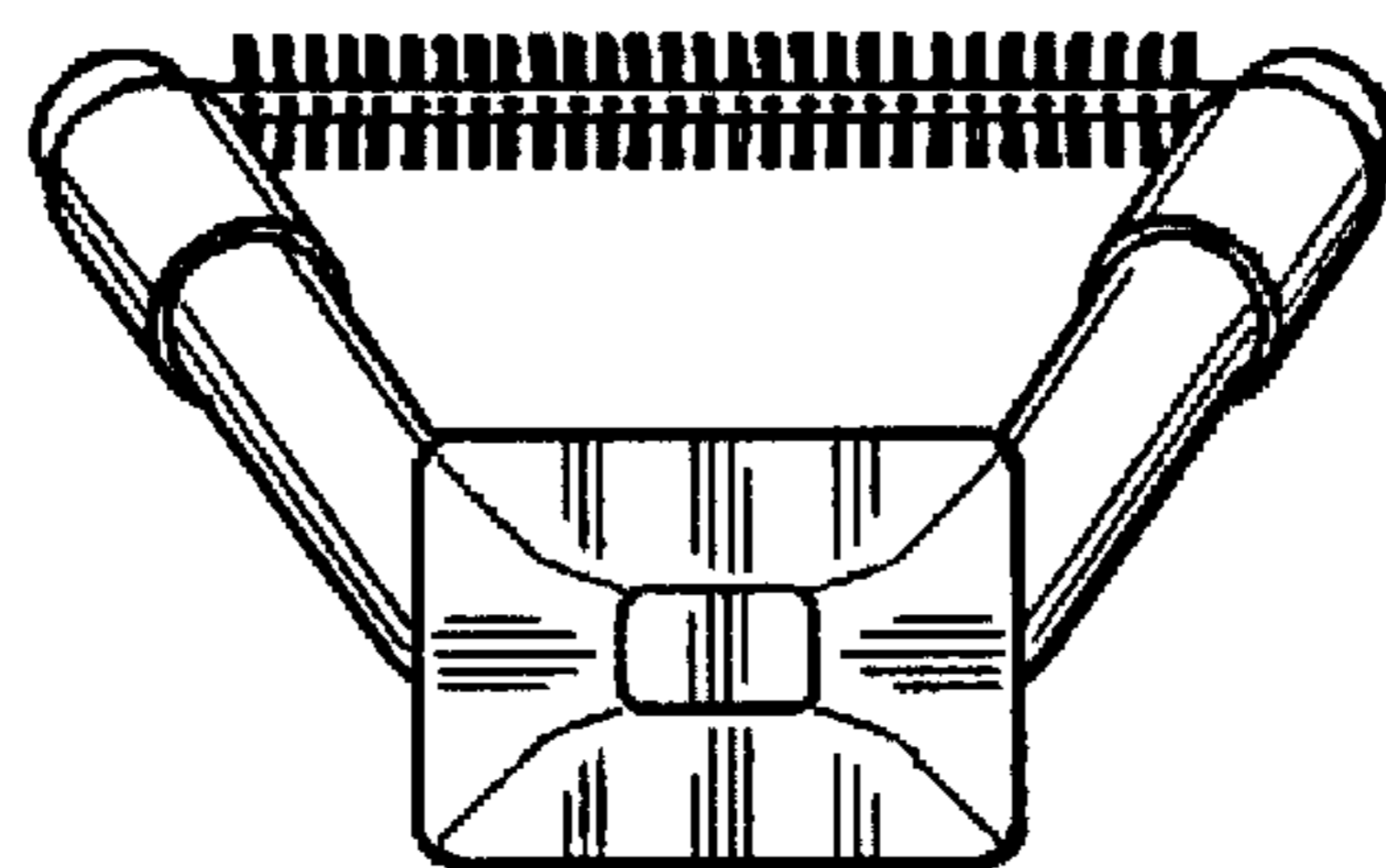

FIG 6

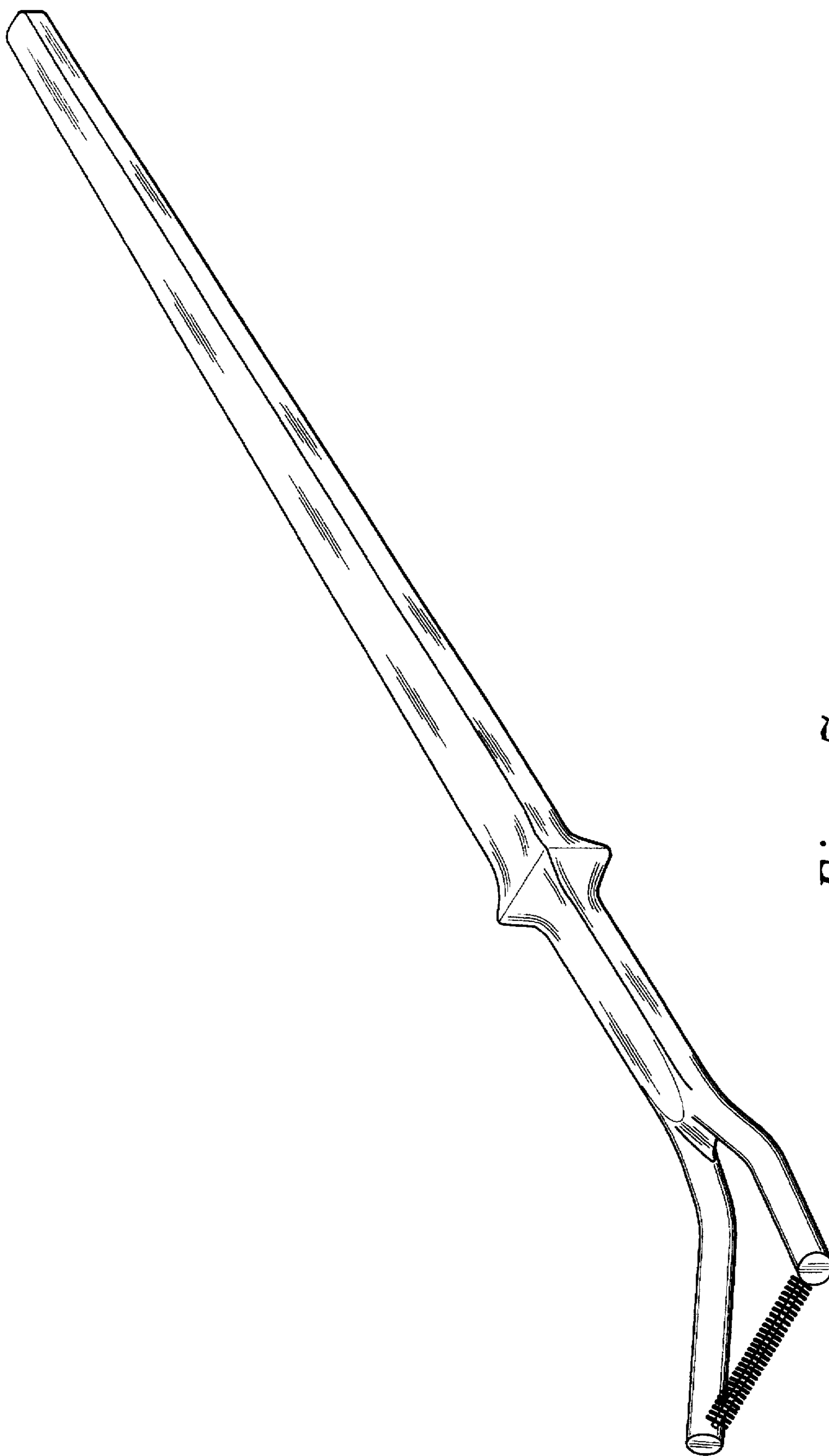

Fig. 7

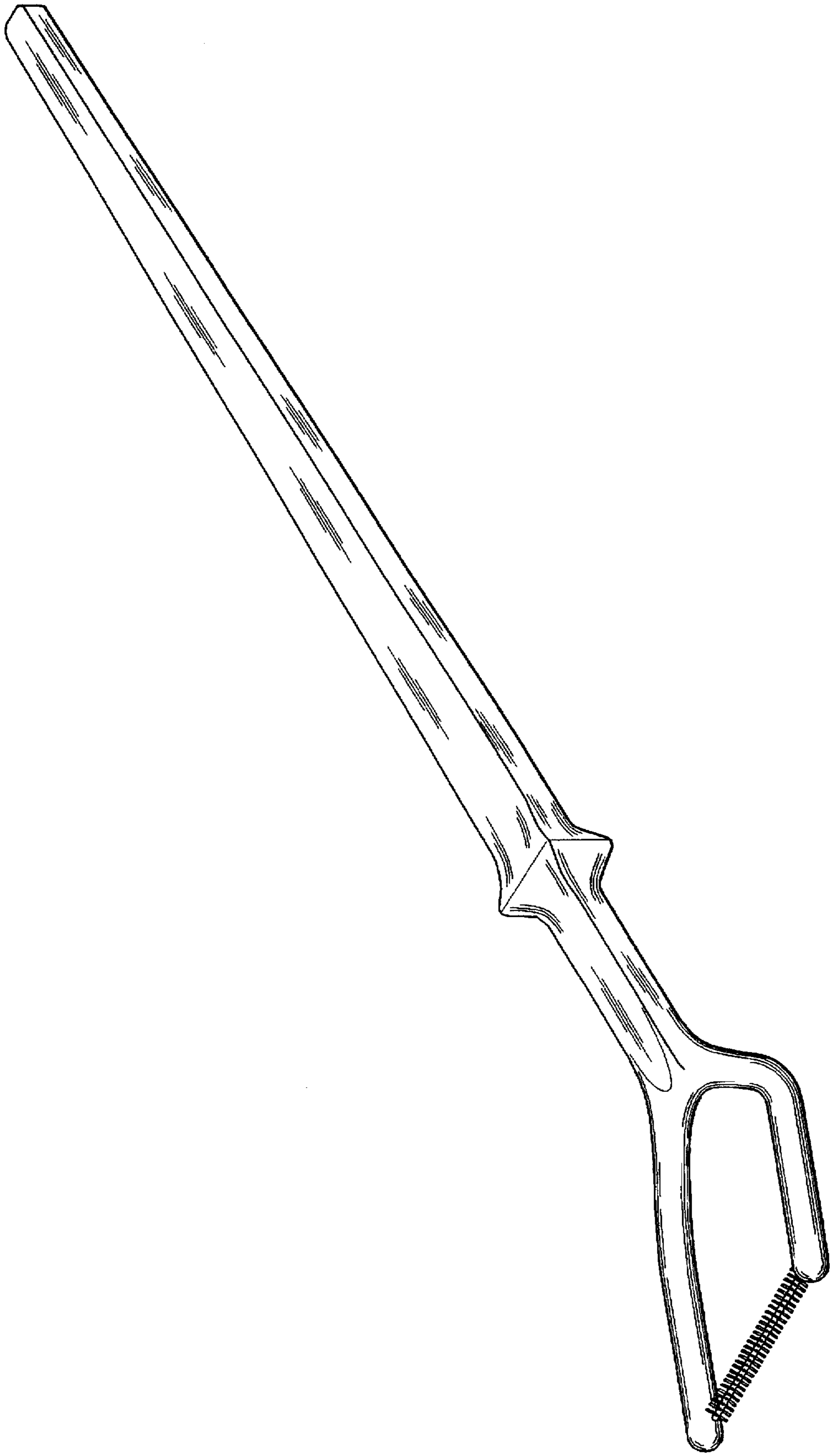

FIG 8

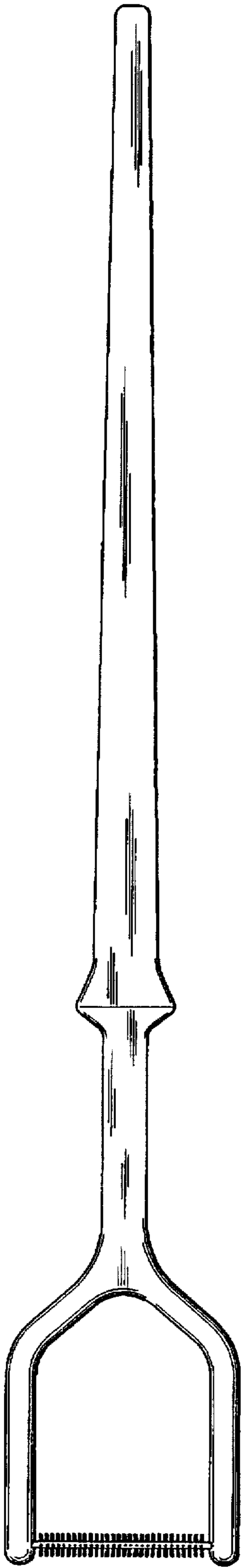

FIG 9

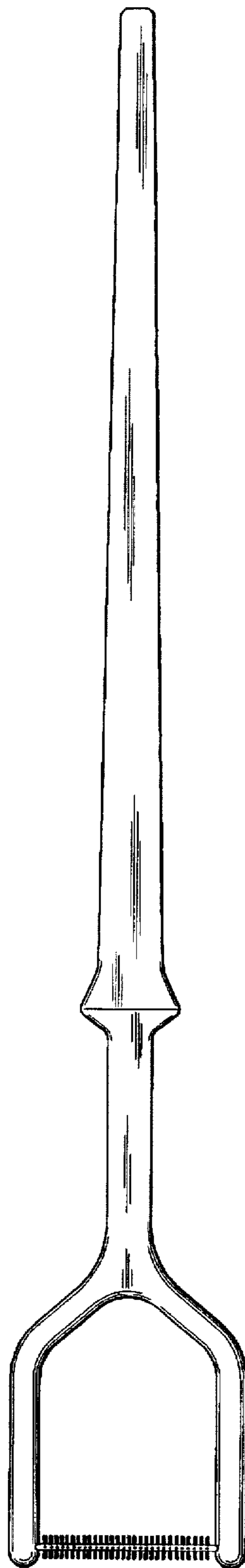

FIG 10

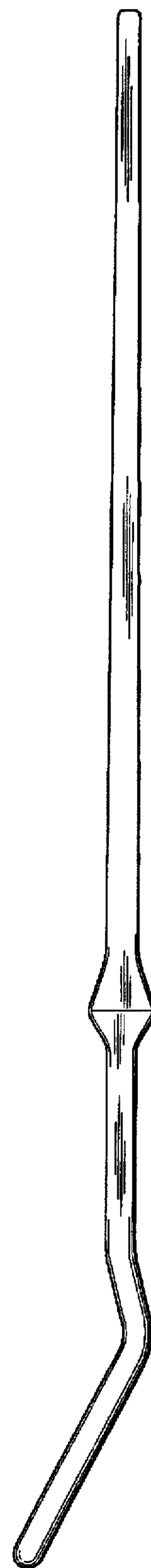

FIG 11

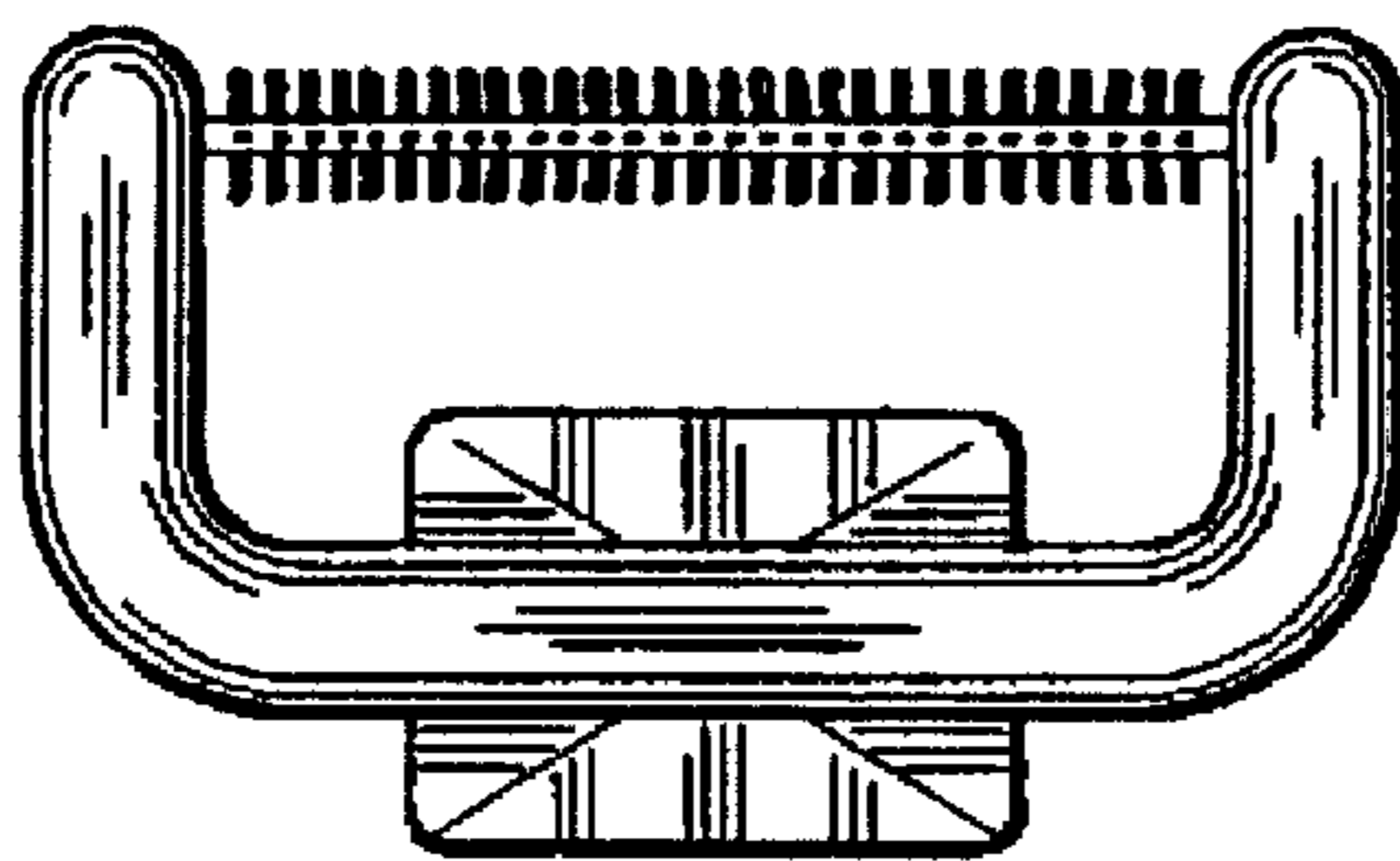

FIG 12

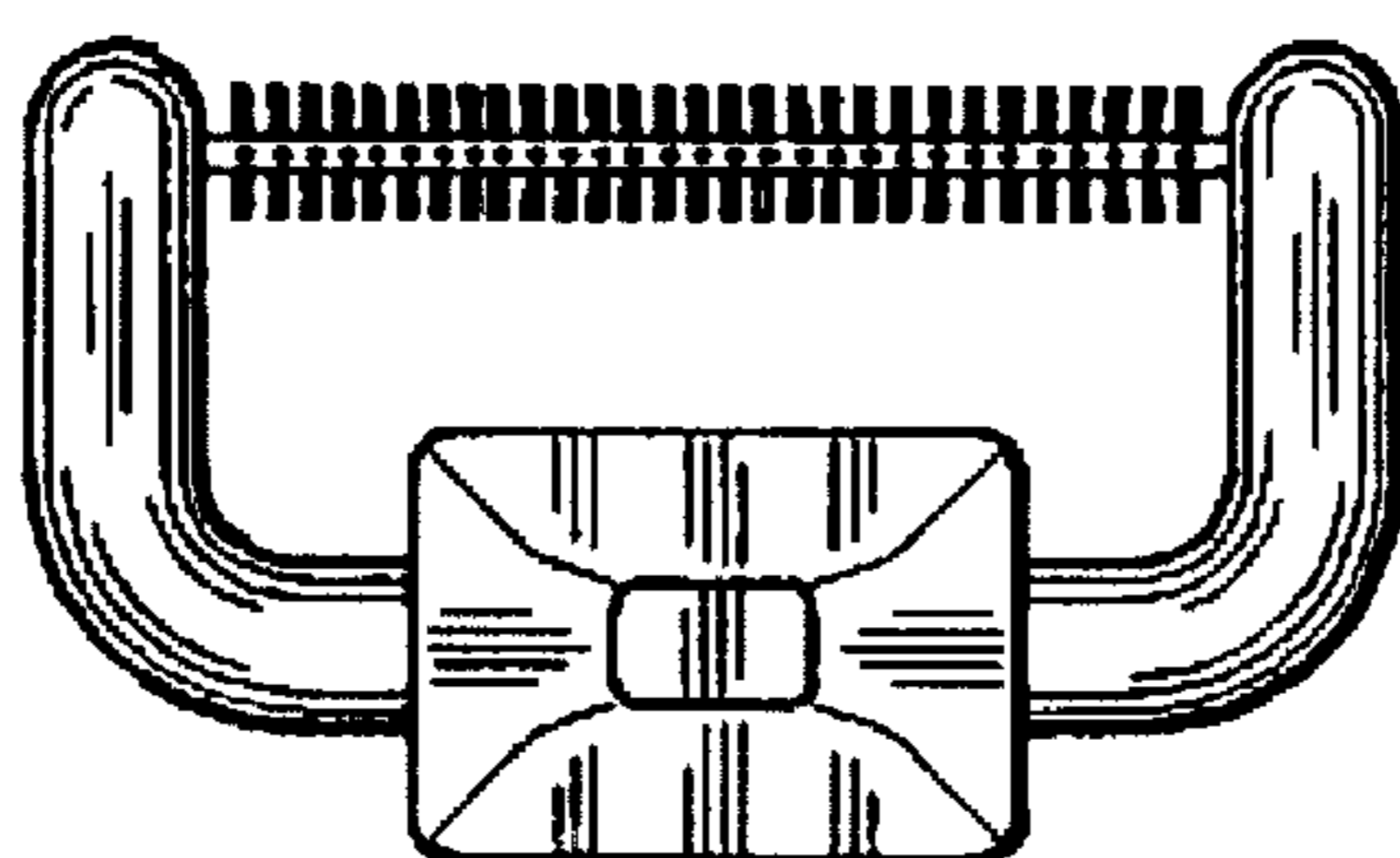

FIG 13