



US00D386528S

**United States Patent** [19]  
**Mori**

[11] **Patent Number:** **Des. 386,528**  
[45] **Date of Patent:** **\*\*Nov. 18, 1997**

[54] **PUNCH**  
[75] **Inventor:** **Chuzo Mori, Katsushika-ku, Japan**  
[73] **Assignee:** **Carl Jimuki Kabushiki Kaisha, Tokyo, Japan**  
[\*\*] **Term:** **14 Years**  
[21] **Appl. No.:** **62,223**  
[22] **Filed:** **Nov. 12, 1996**  
[51] **LOC (6) Cl.** ..... **19-02**  
[52] **U.S. Cl.** ..... **D19/72; D15/123; D15/128**  
[58] **Field of Search** ..... **D15/123, 128; D19/22; 83/167, 468, 520, 588, 618, 620, 633, 699, 698, 698.71, 698.91, 856, 859**

*Primary Examiner—Antoine Duval Davis*  
*Attorney, Agent, or Firm—Oliff & Berridge*

[57] **CLAIM**

The ornamental design for punch, as shown and described.

**DESCRIPTION**

FIG. 1 is a perspective view of a punch showing my design; FIG. 2 is an elevational front view of the punch of FIG. 1; FIG. 3 is a top plan view of the punch of FIG. 1; FIG. 4 is a right-side view of the punch of FIG. 1; FIG. 5 is a left-side view of the punch of FIG. 1; FIG. 6 is a rear view of the punch of FIG. 1; FIG. 7 is a bottom view of the punch of FIG. 1; and, FIG. 8 is a perspective view showing a state that a lever of the punch is raised up.

[56] **References Cited**

**U.S. PATENT DOCUMENTS**

4,466,322 8/1984 Mori ..... 83/468  
4,713,995 12/1987 Davi ..... 83/167

**1 Claim, 5 Drawing Sheets**

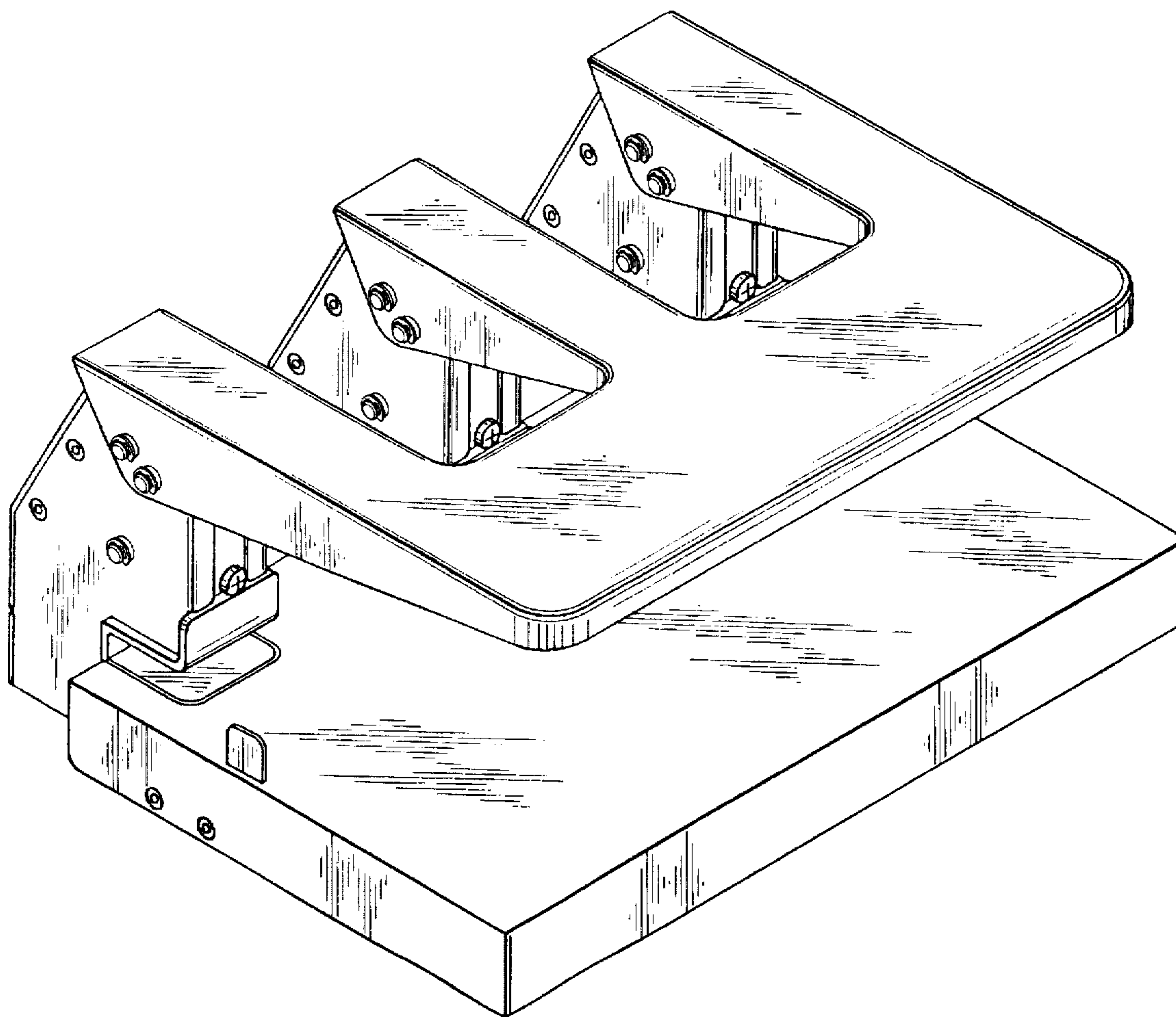

FIG. 1

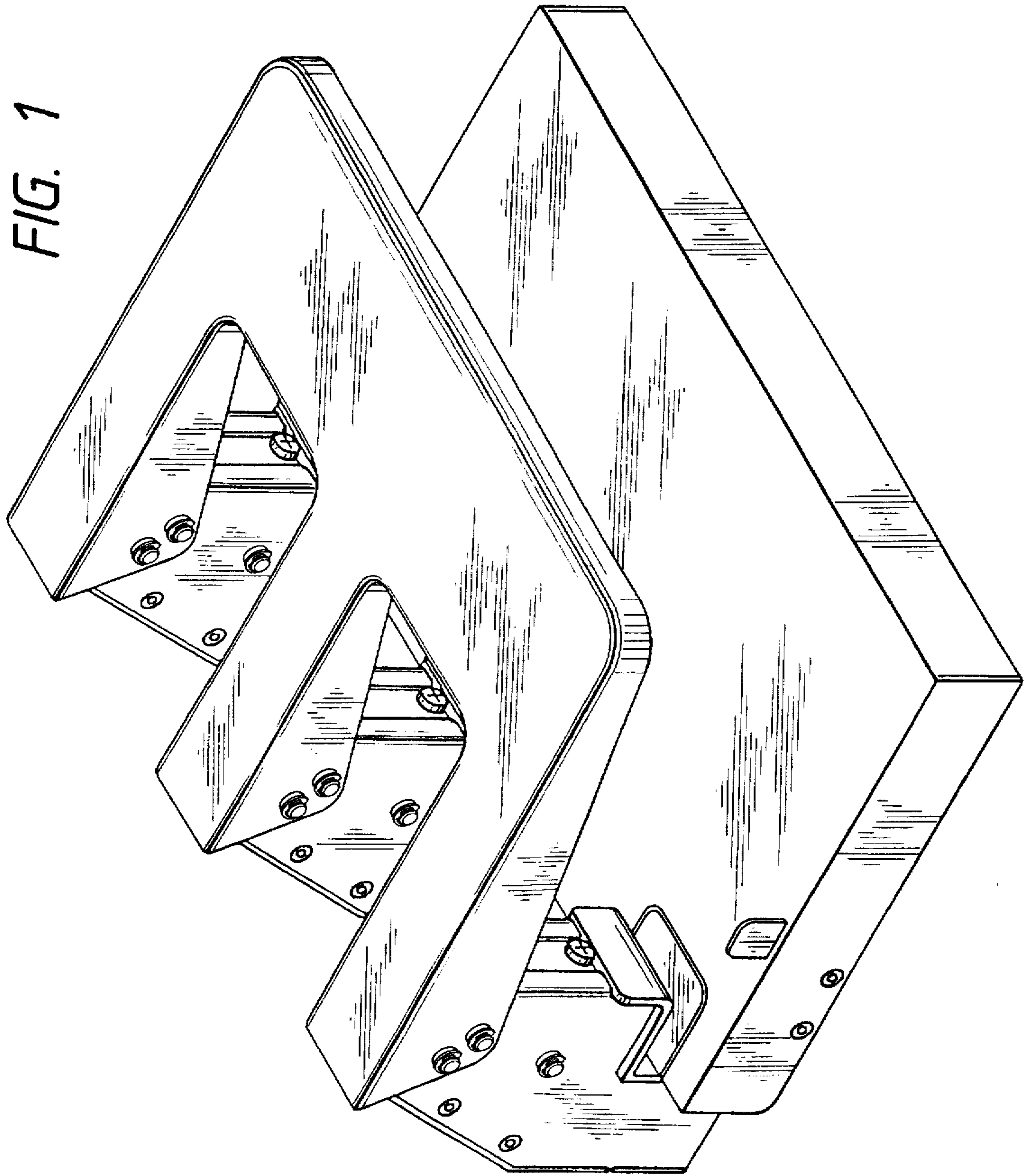

FIG. 2

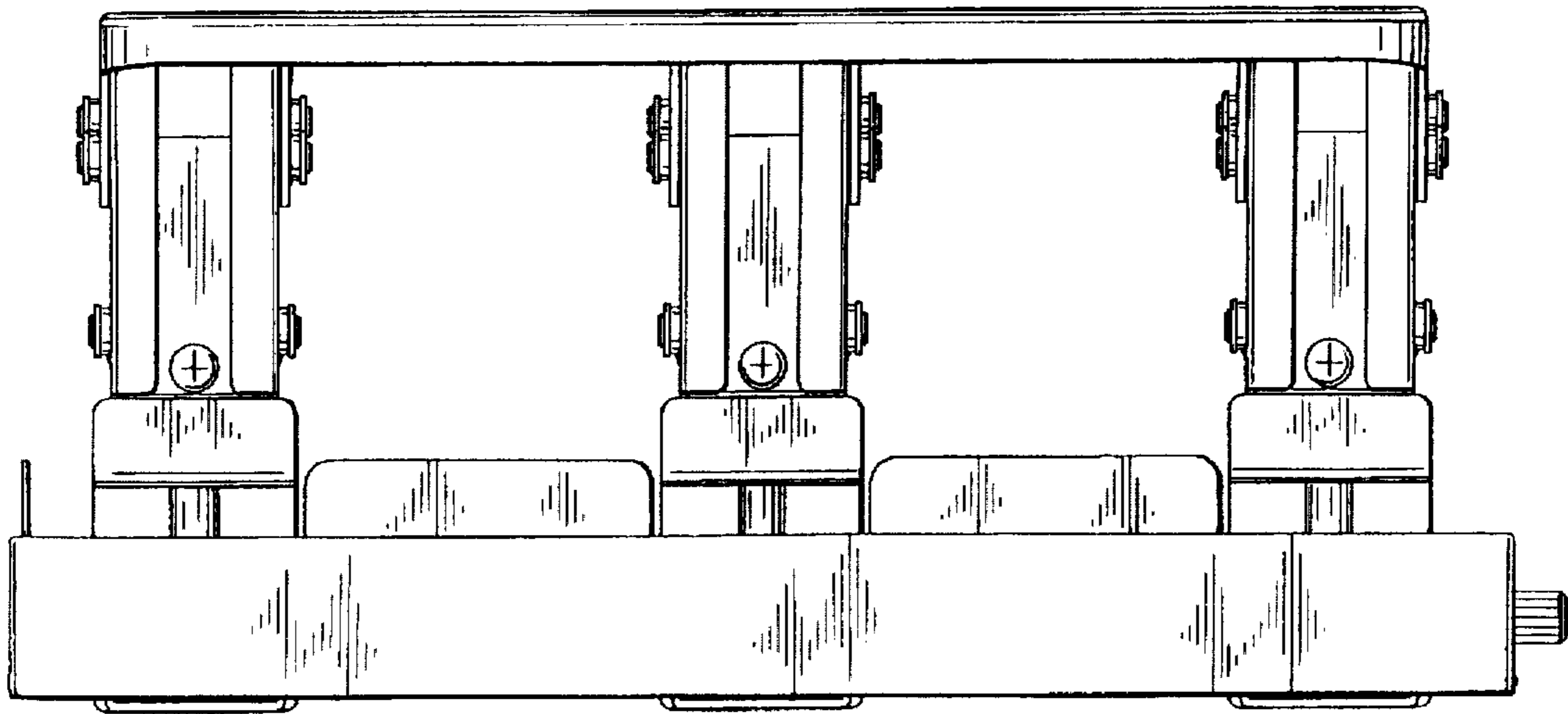

FIG. 3

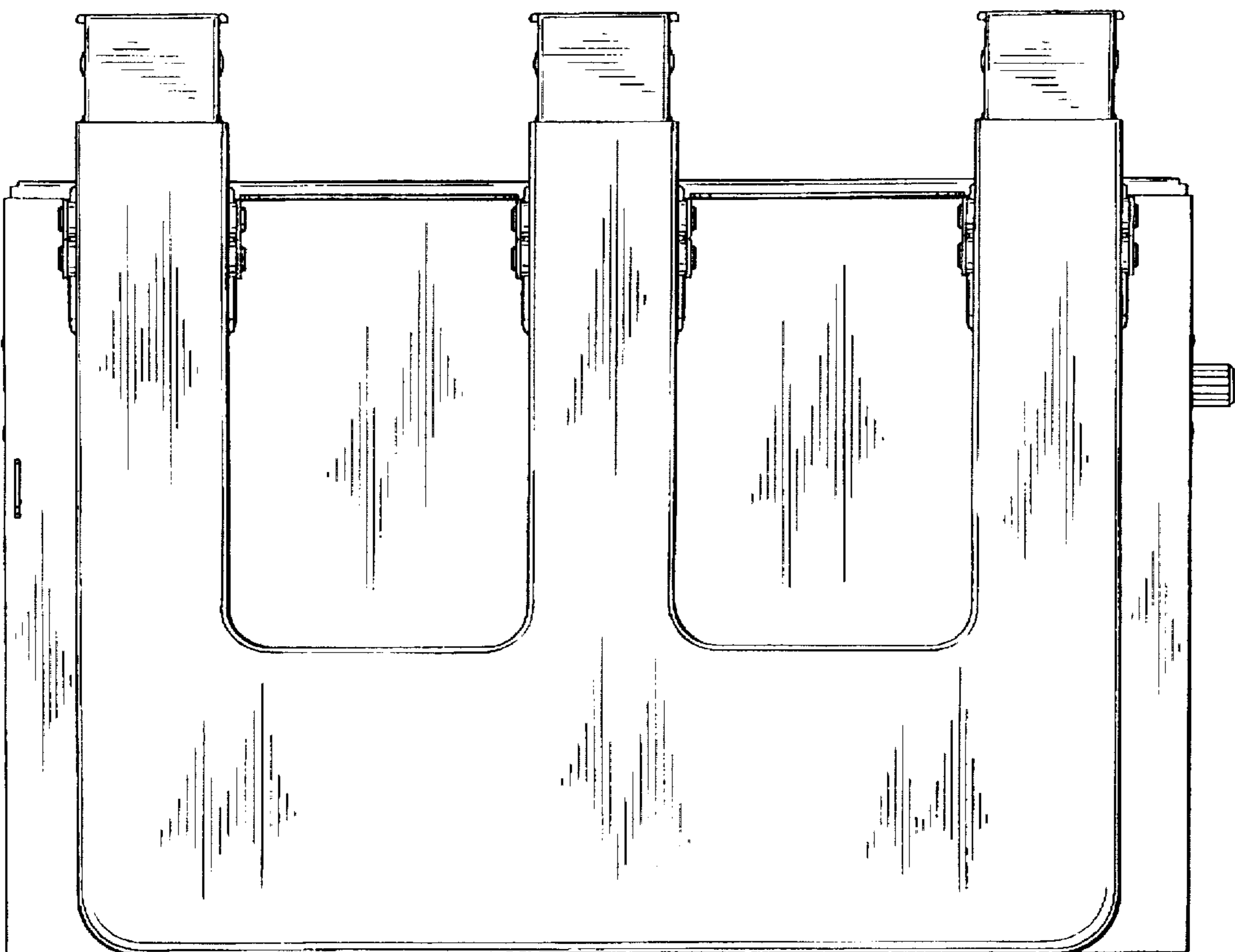

FIG. 4

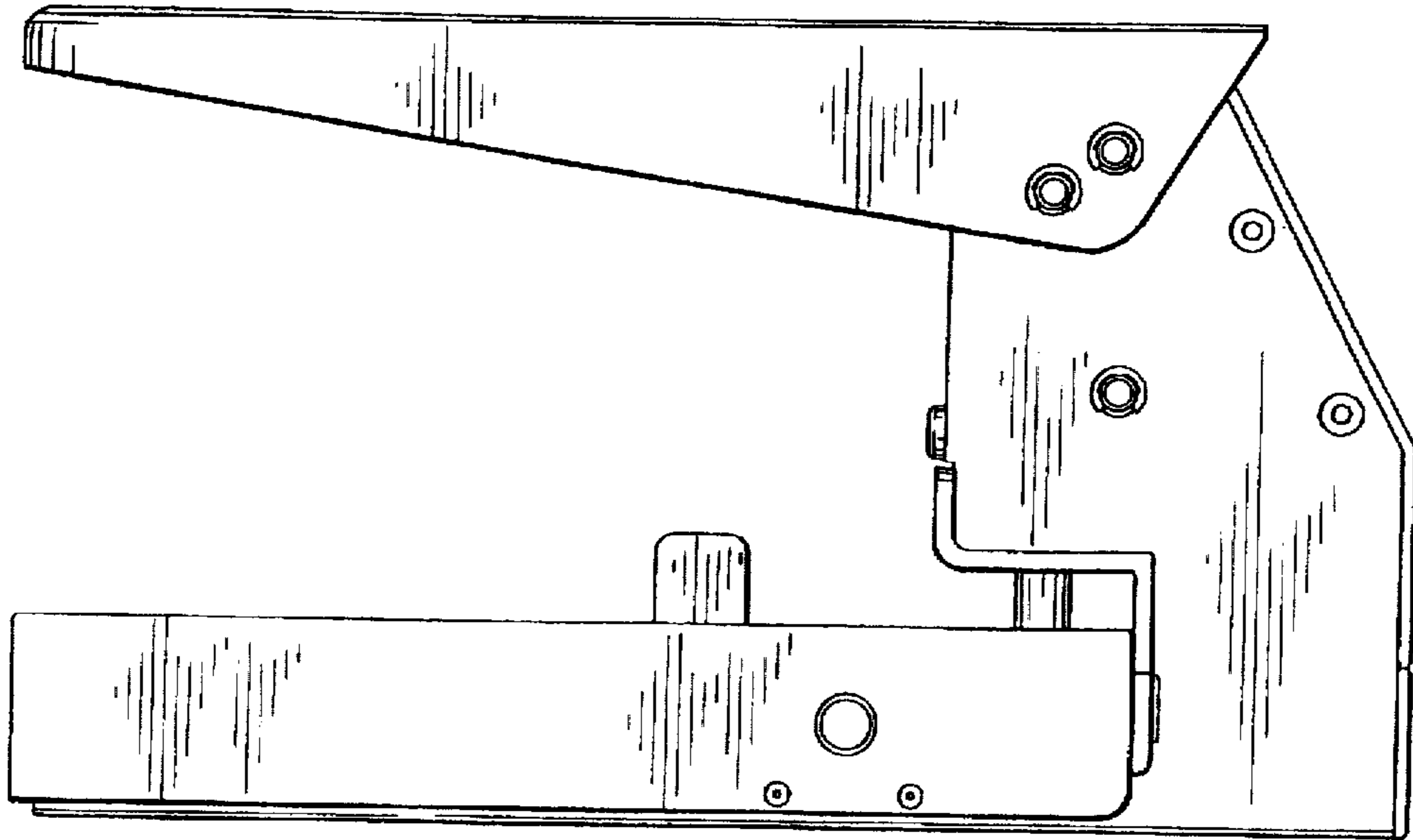

FIG. 5

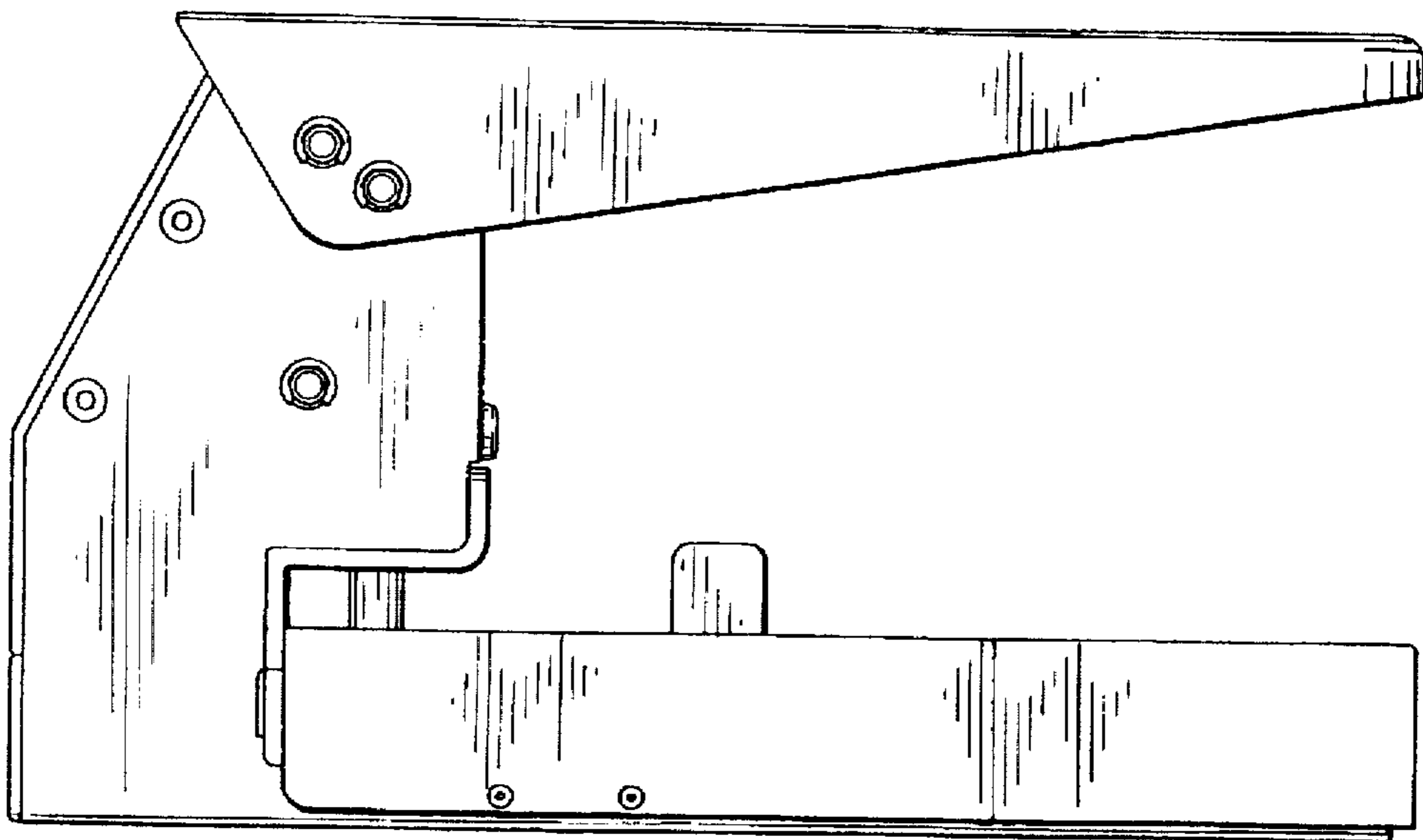



FIG. 6

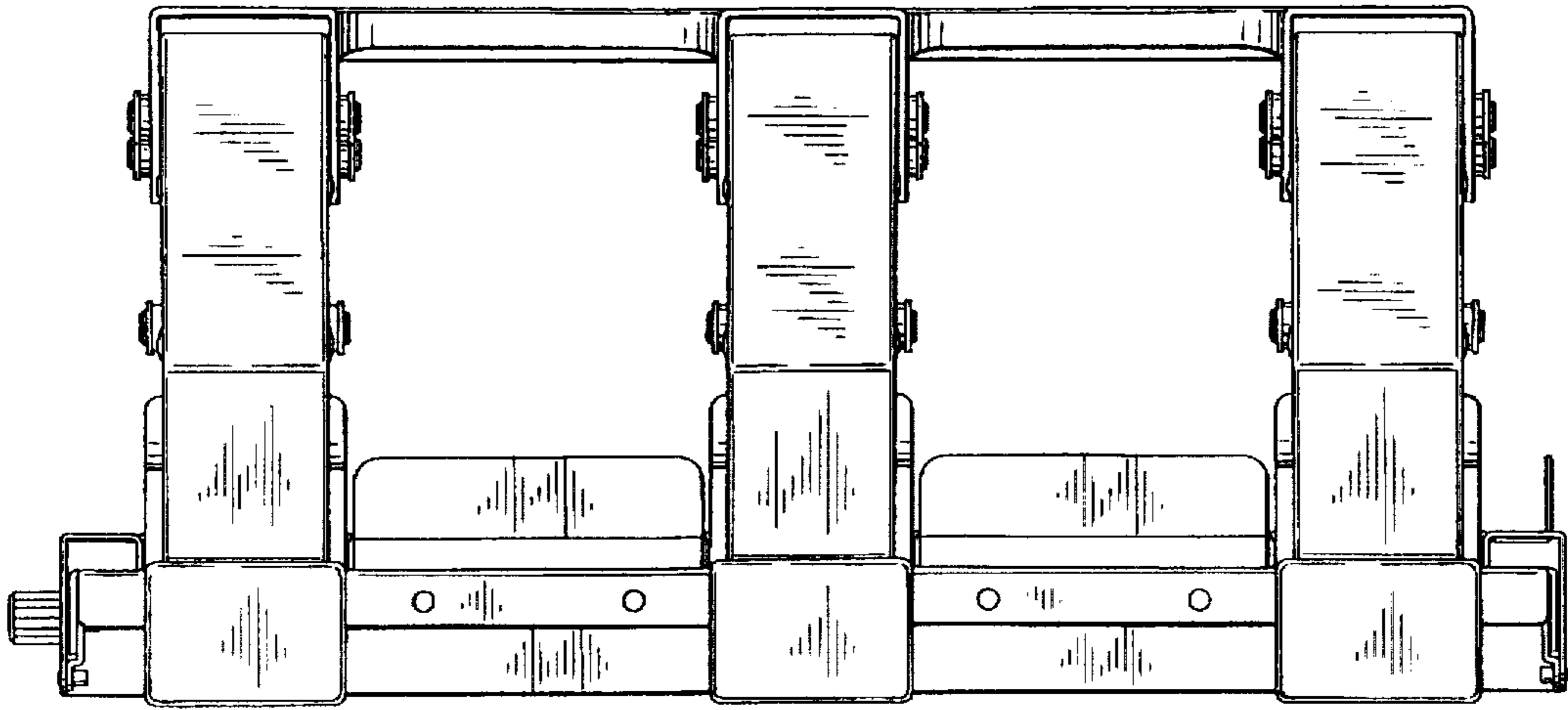

FIG. 7

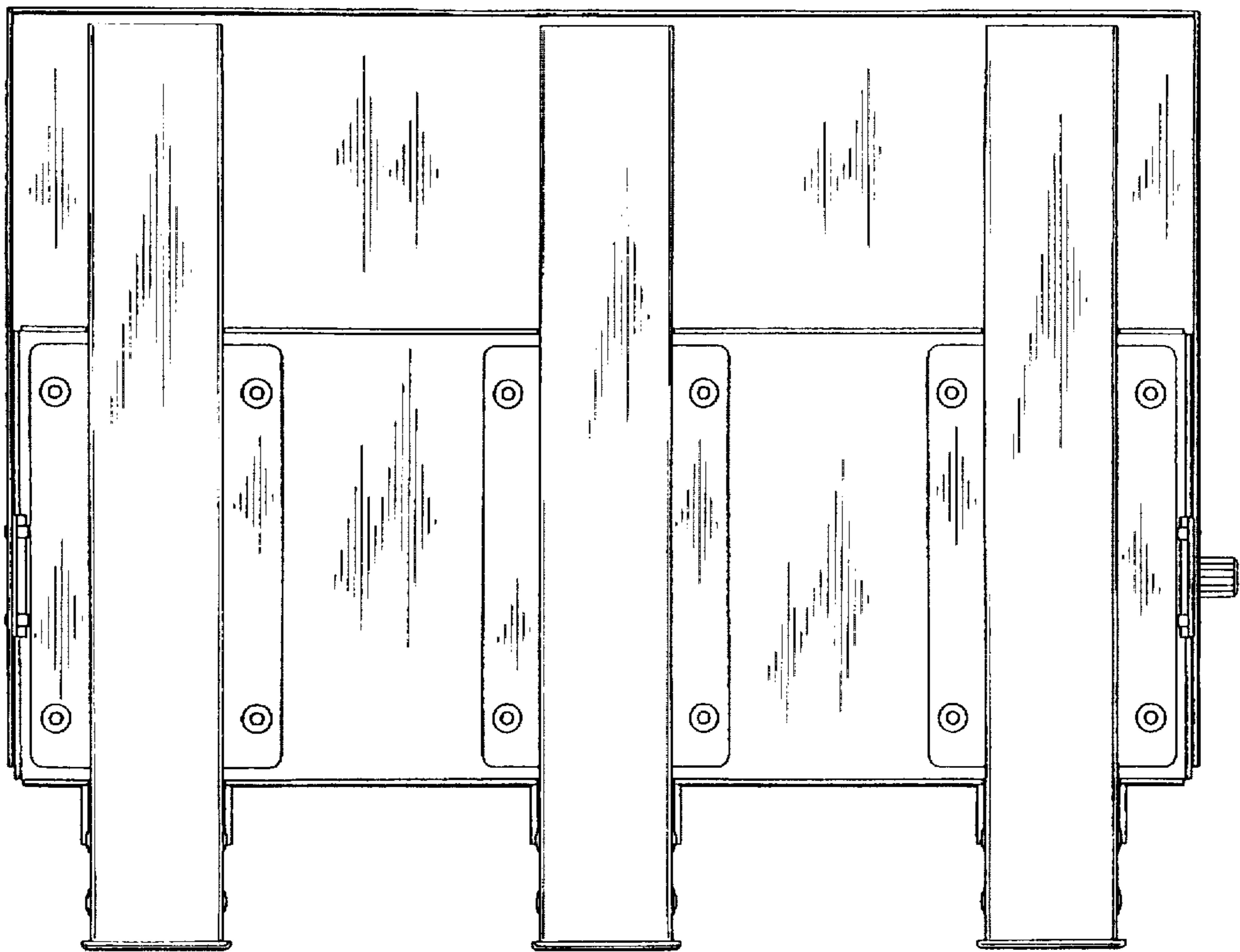
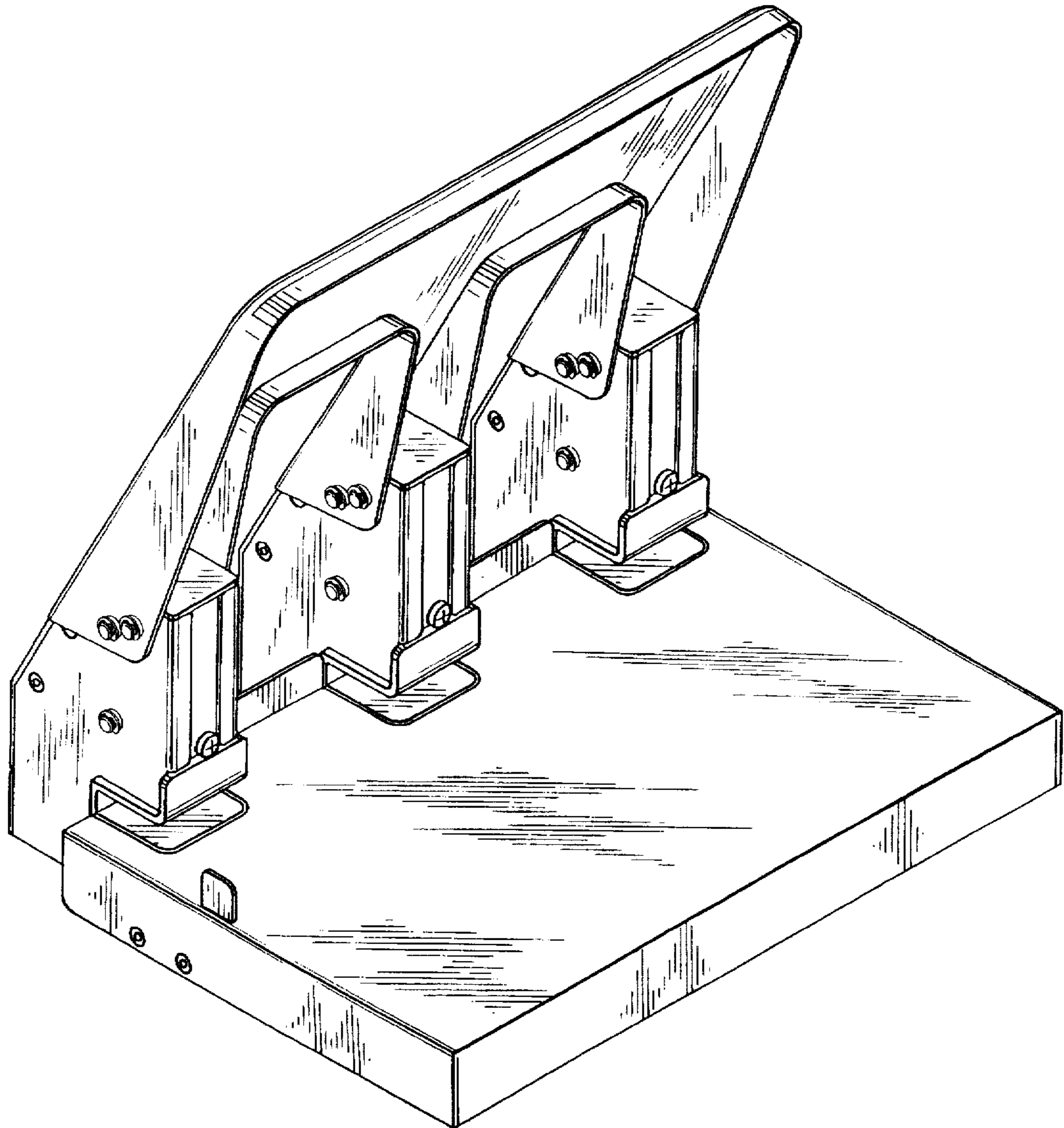

FIG. 8



UNITED STATES PATENT AND TRADEMARK OFFICE  
**CERTIFICATE OF CORRECTION**

PATENT NO. : Des. 386,528  
DATED : November 18, 1997  
INVENTOR(S) : Chuzo MORI

It is certified that error appears in the above-identified patent and that said Letters Patent is hereby corrected as shown below:

On the title page, item [75], change the inventor's residence from "Katsuhika-ku, Japan" to --Tokyo, Japan--;

under item [56], in the list of references cited, add --U.S. Des. 306,460, 3/1990, MORI--;

under item [56], in the list of references cited, add --Taiwan 281,516, 7/1996--; and

under Description, in the description of Figure 1, change "persepctive" to --perspective--.

Signed and Sealed this  
Third Day of March, 1998



BRUCE LEHMAN

Commissioner of Patents and Trademarks

Attest:

Attesting Officer