



US00D386518S

United States Patent [19]

Miyamoto et al.

[11] Patent Number: **Des. 386,518**

[45] Date of Patent: ****Nov. 18, 1997**

[54] **IMAGE FORMING APPARATUS**

D. 348,689 7/1994 Kikuchi et al. D18/43
D. 359,304 6/1995 Smith et al. D18/43

[75] Inventors: **Noriaki Miyamoto**, Yokohama; **Ryoko Unishi**, Kawasaki, both of Japan

Primary Examiner—Caron D. Veynar
Attorney, Agent, or Firm—Fitzpatrick, Cella, Harper & Scinto

[73] Assignee: **Canon Kabushiki Kaisha**, Tokyo, Japan

[**] Term: **14 Years**

[57] **CLAIM**

[21] Appl. No.: **52,298**

The ornamental design for an image forming apparatus, as shown and described.

[22] Filed: **Mar. 27, 1996**

DESCRIPTION

[30] **Foreign Application Priority Data**

May 30, 1995 [JP] Japan 7-15262

FIG. 1 is a front view of an image forming apparatus showing our new design;

[51] LOC (6) Cl. **16-03**

FIG. 2 is a rear view thereof;

[52] U.S. Cl. **D18/43; D18/40**

FIG. 3 is a top plan view thereof;

[58] **Field of Search** **D18/36, 40, 43;**

222/DIG. 1, 166, 240, 325, 546; 355/206,

208, 245, 260, 298; 206/216, 229, 316;

118/653

FIG. 4 is a bottom plan view thereof;

FIG. 5 is a left side view thereof;

FIG. 6 is a right side view thereof; and,

FIG. 7 is a perspective view thereof.

[56] **References Cited**

U.S. PATENT DOCUMENTS

D. 321,716 11/1991 Kikuchi et al. D18/43

1 Claim, 3 Drawing Sheets

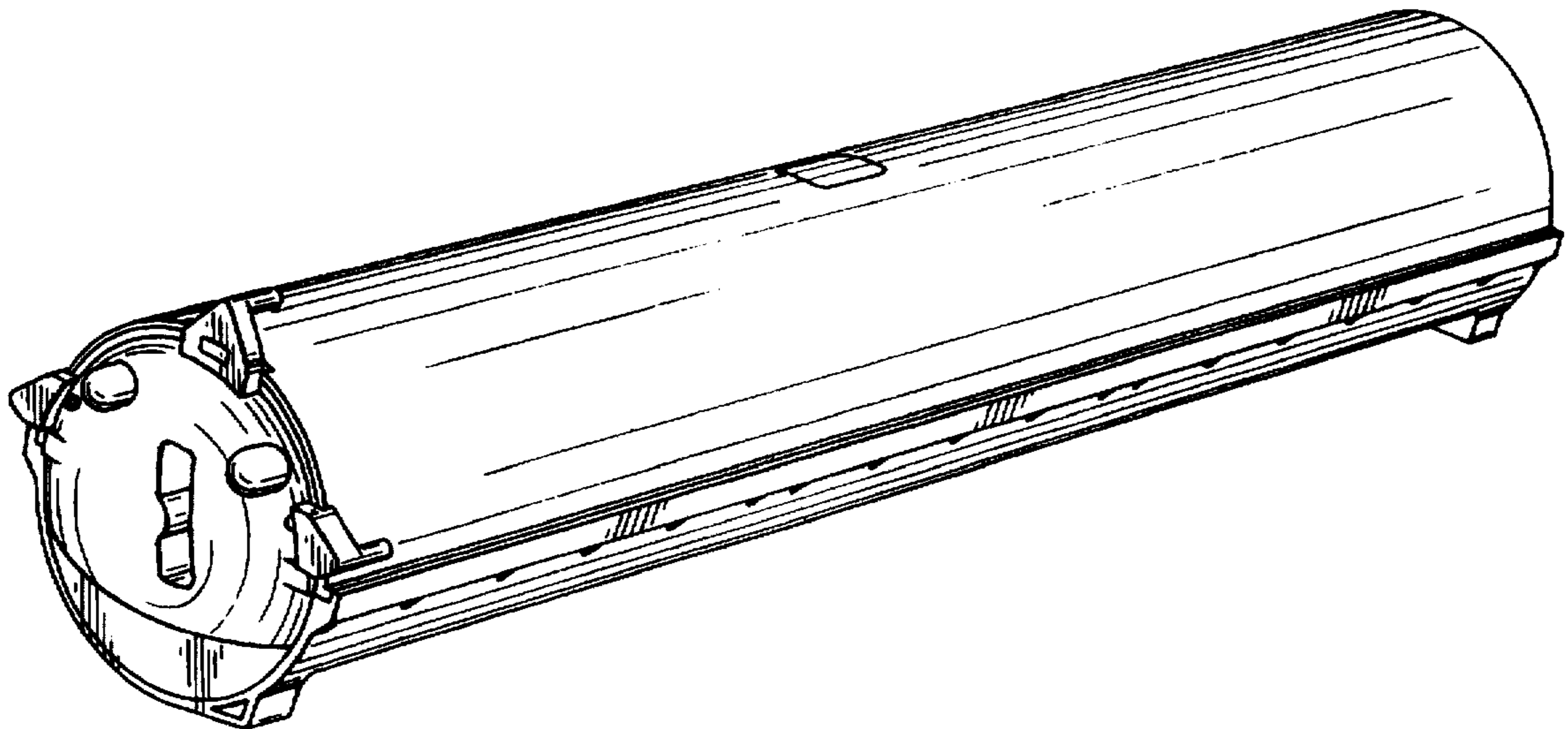

FIG. 1

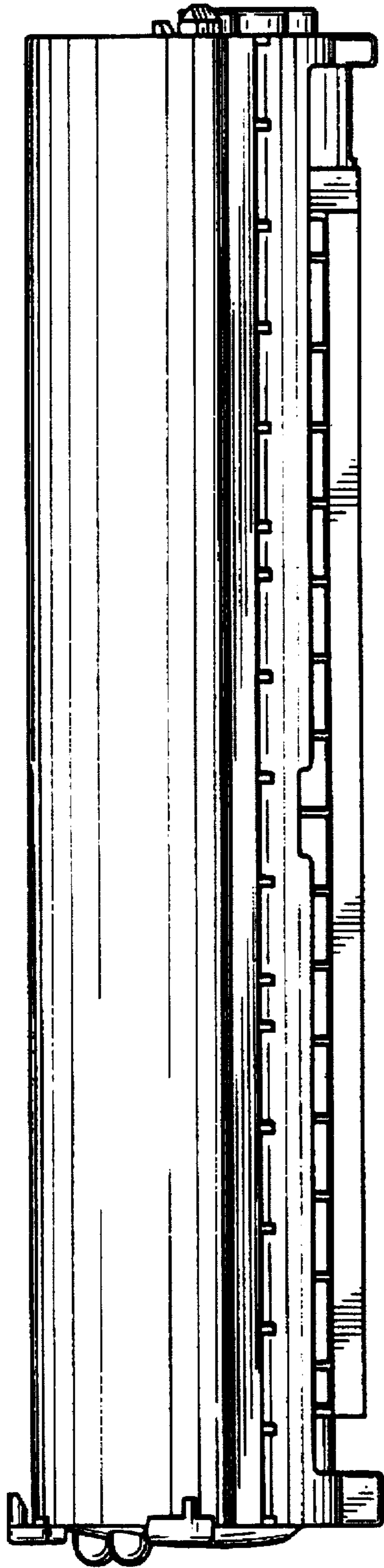

FIG. 2

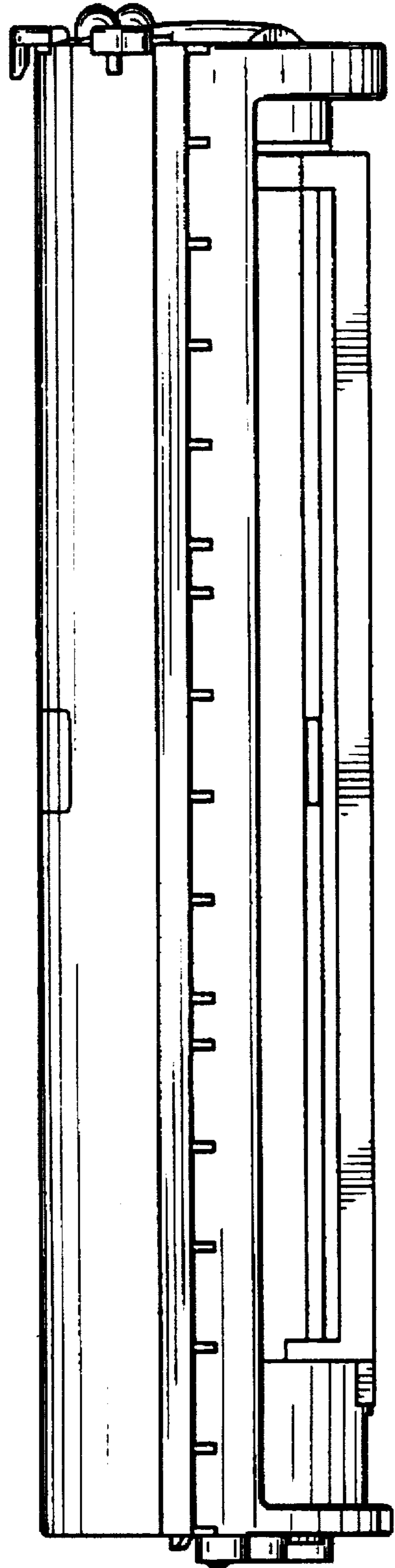

FIG. 3

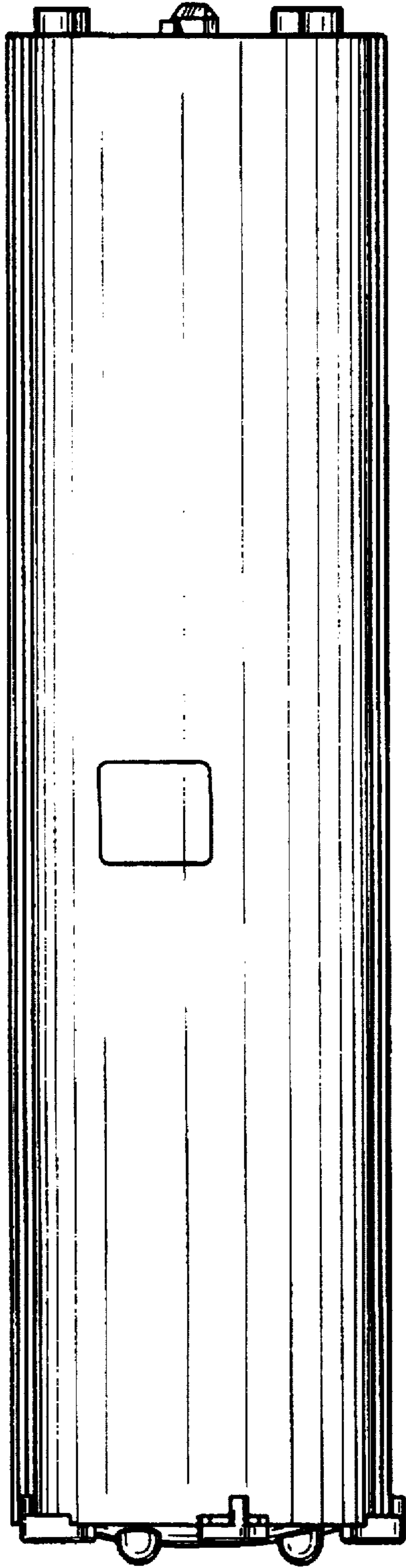

FIG. 4

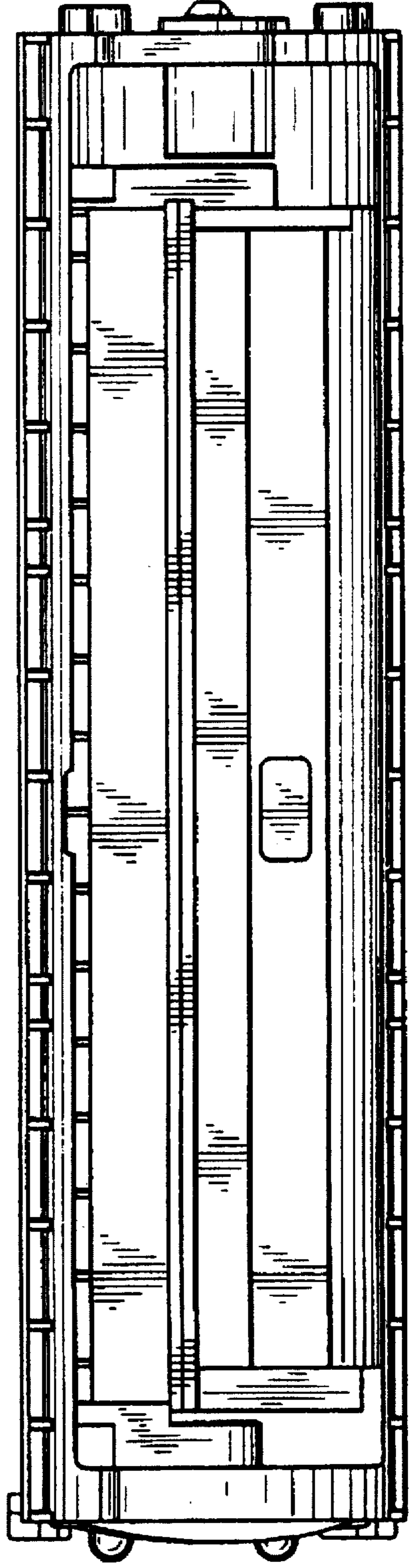

FIG. 5

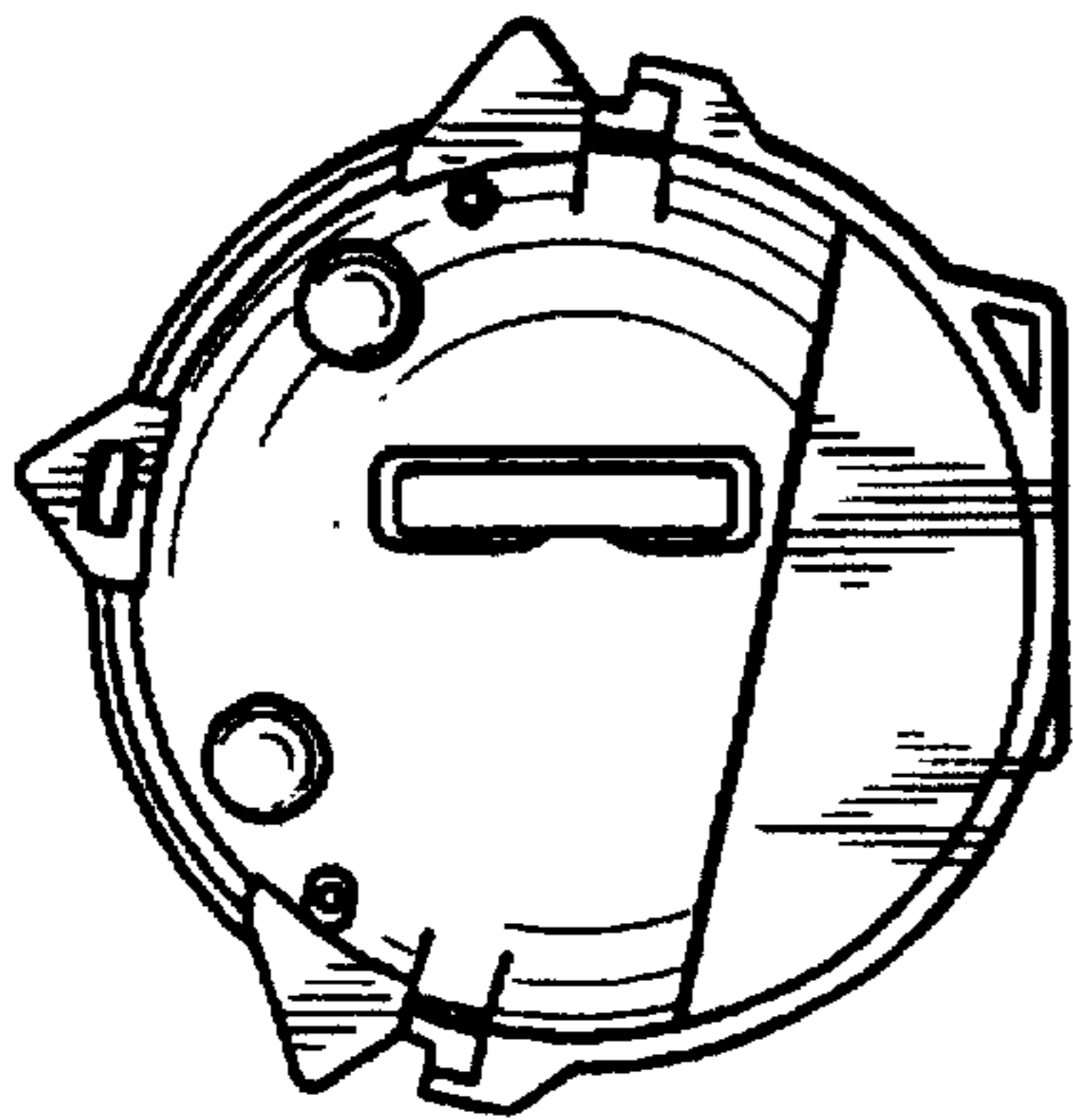

FIG. 6

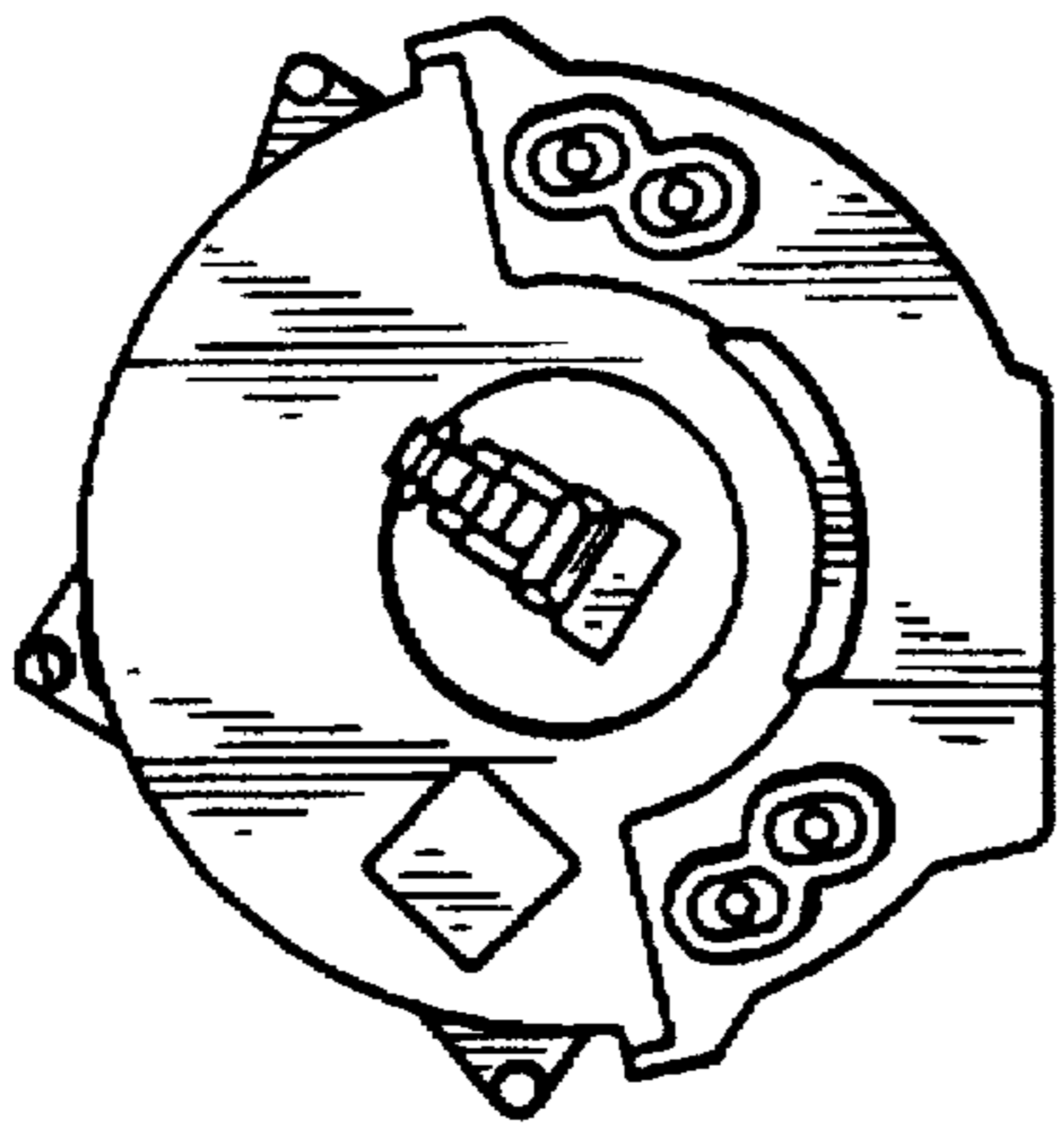

FIG. 7

