



US00D386508S

**United States Patent** [19]  
**Ohwada**

[11] **Patent Number: Des. 386,508**

[45] **Date of Patent: \*\*Nov. 18, 1997**

[54] **VIDEO CAMERA WITH VIDEO TAPE RECORDER**

[75] **Inventor: Masahito Ohwada, Yokohama, Japan**

[73] **Assignee: Canon Kabushiki Kaisha, Tokyo, Japan**

[\*\*] **Term: 14 Years**

[21] **Appl. No.: 59,362**

[22] **Filed: Sep. 9, 1996**

[30] **Foreign Application Priority Data**

Mar. 21, 1996 [JP] Japan ..... 8-7720

[51] **LOC (6) Cl. .... 16-01**

[52] **U.S. Cl. .... D16/202**

[58] **Field of Search .... D16/200-205, D16/208; 348/373-376; 352/242, 243; 358/906; 396/29, 535-543; H04N 2/225**

[56] **References Cited**

**U.S. PATENT DOCUMENTS**

- D. 346,614 5/1994 Sumita ..... D16/202
- D. 355,664 2/1995 Kataoka ..... D16/202
- D. 362,452 9/1995 Matsumura ..... D16/202

- D. 368,922 4/1996 Tanaka ..... D16/202
- 5,499,052 3/1996 Nakanishi et al. .... 358/906

**FOREIGN PATENT DOCUMENTS**

- 406086123 3/1994 Japan ..... H04N 5/225

**OTHER PUBLICATIONS**

Video Magazine, Jan. 1993 p. 91 (Yashica KX-V1-H1 8).

*Primary Examiner*—Philip S. Hyder

*Assistant Examiner*—Adir Aronovich

*Attorney, Agent, or Firm*—Fitzpatrick, Cella, Harper & Scinto

[57] **CLAIM**

The ornamental design for a video camera with video tape recorder, as shown and described.

**DESCRIPTION**

FIG. 1 is a front view of a video camera with video tape recorder showing my new design;

FIG. 2 is a rear view thereof;

FIG. 3 is a top plan view thereof;

FIG. 4 is a bottom plan view thereof;

FIG. 5 is a left side view thereof;

FIG. 6 is a right side view thereof; and,

FIG. 7 is a perspective view thereof.

**1 Claim, 3 Drawing Sheets**

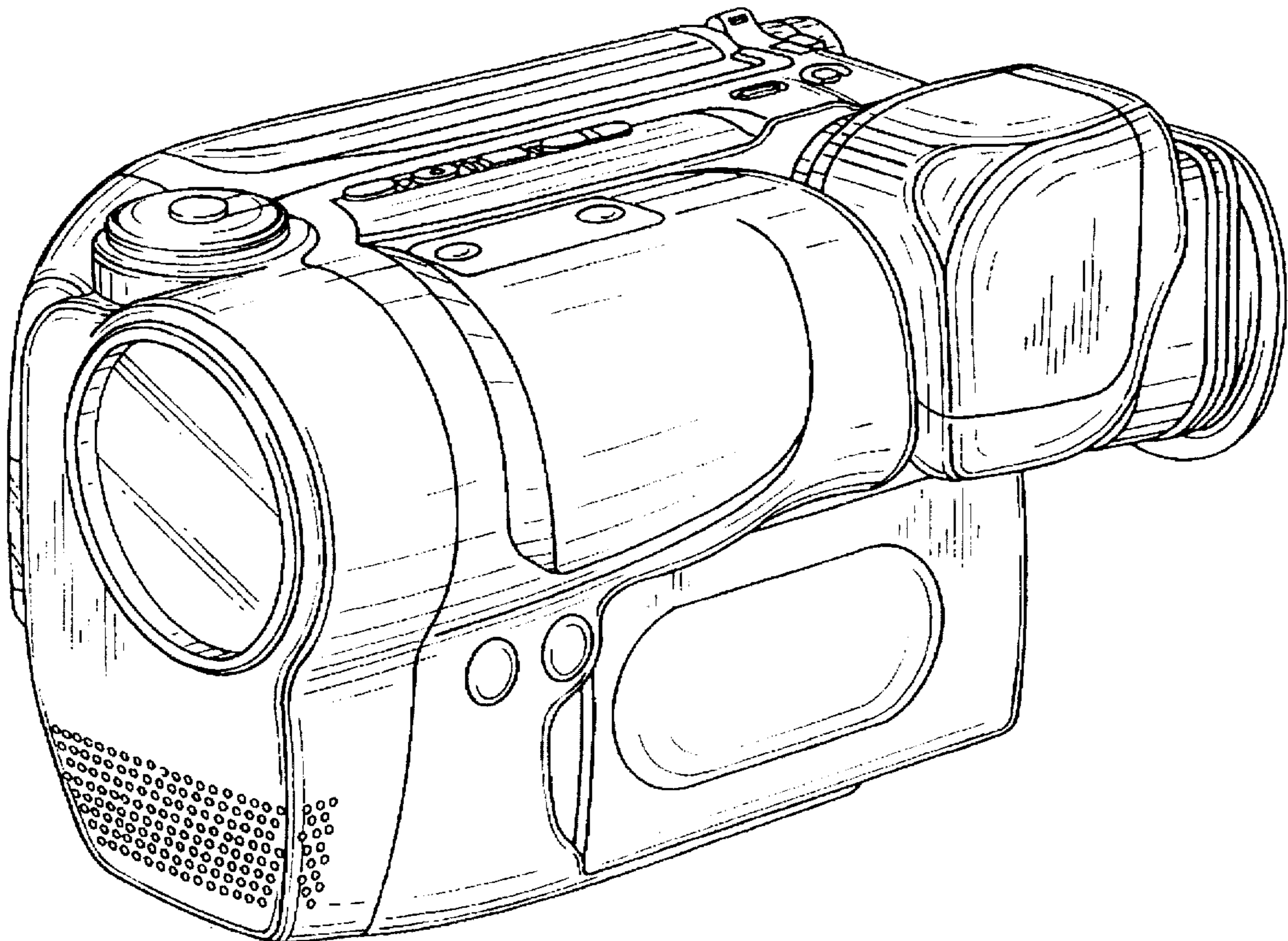

FIG. 1

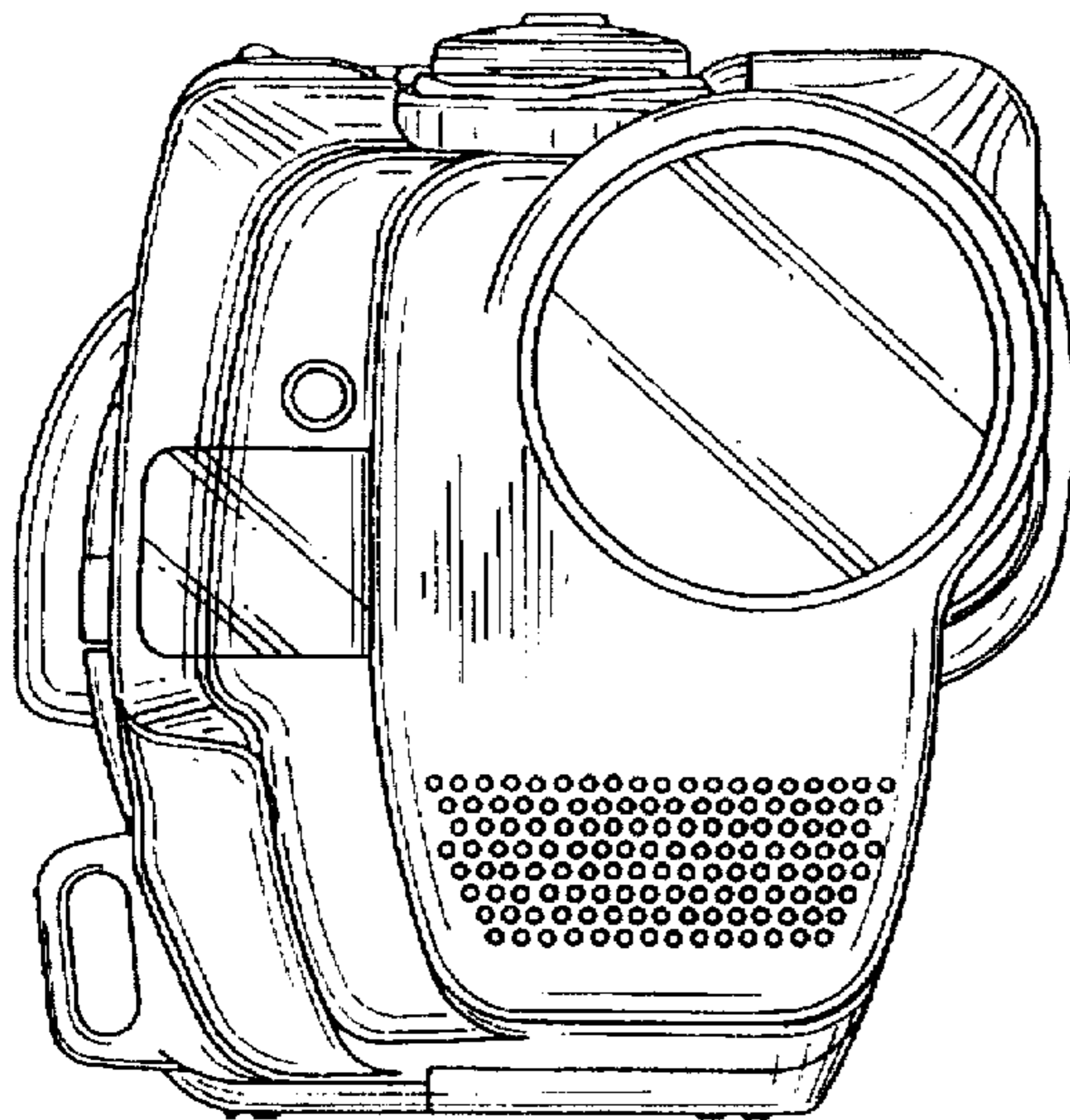

FIG. 2

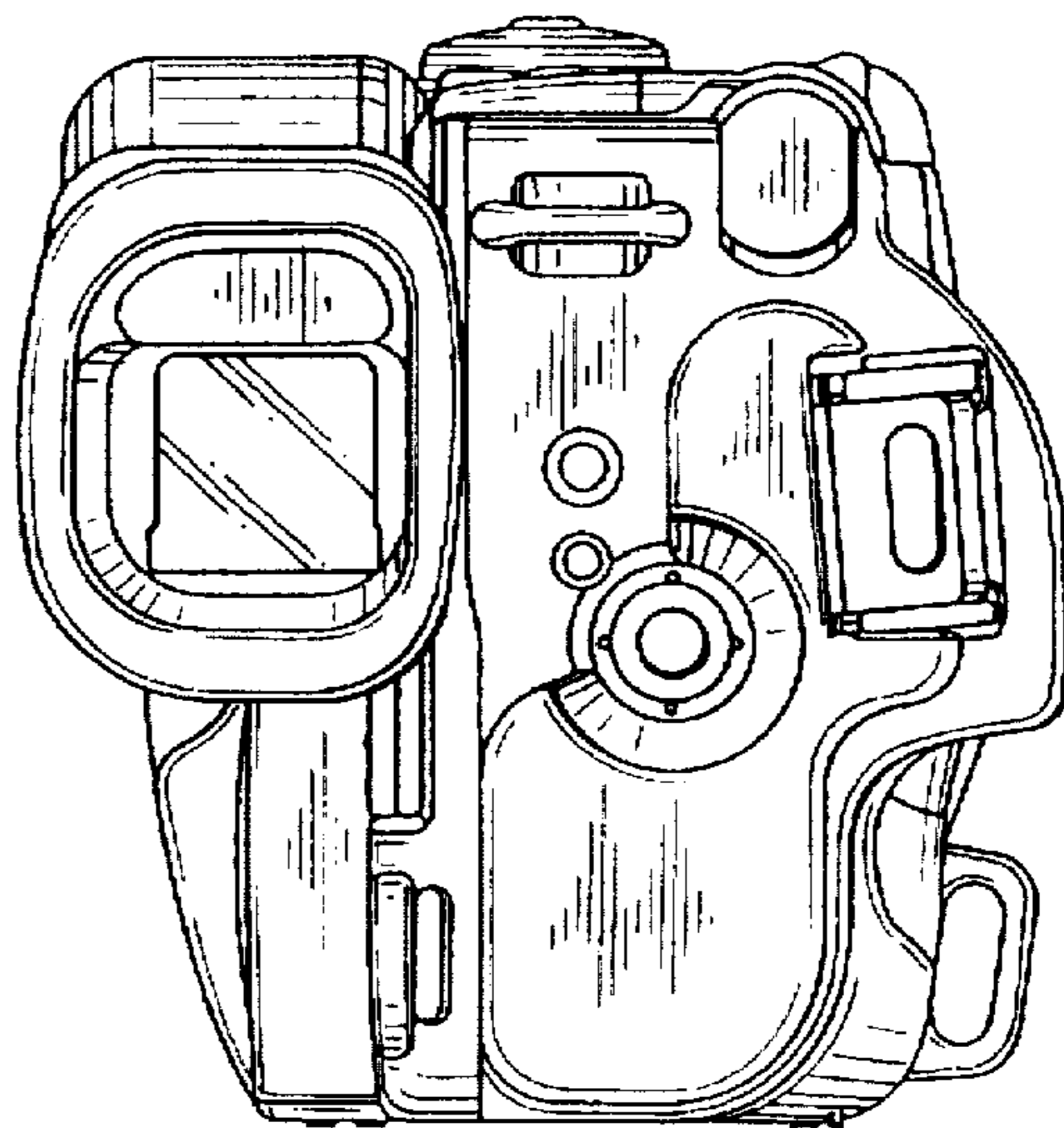

FIG. 3

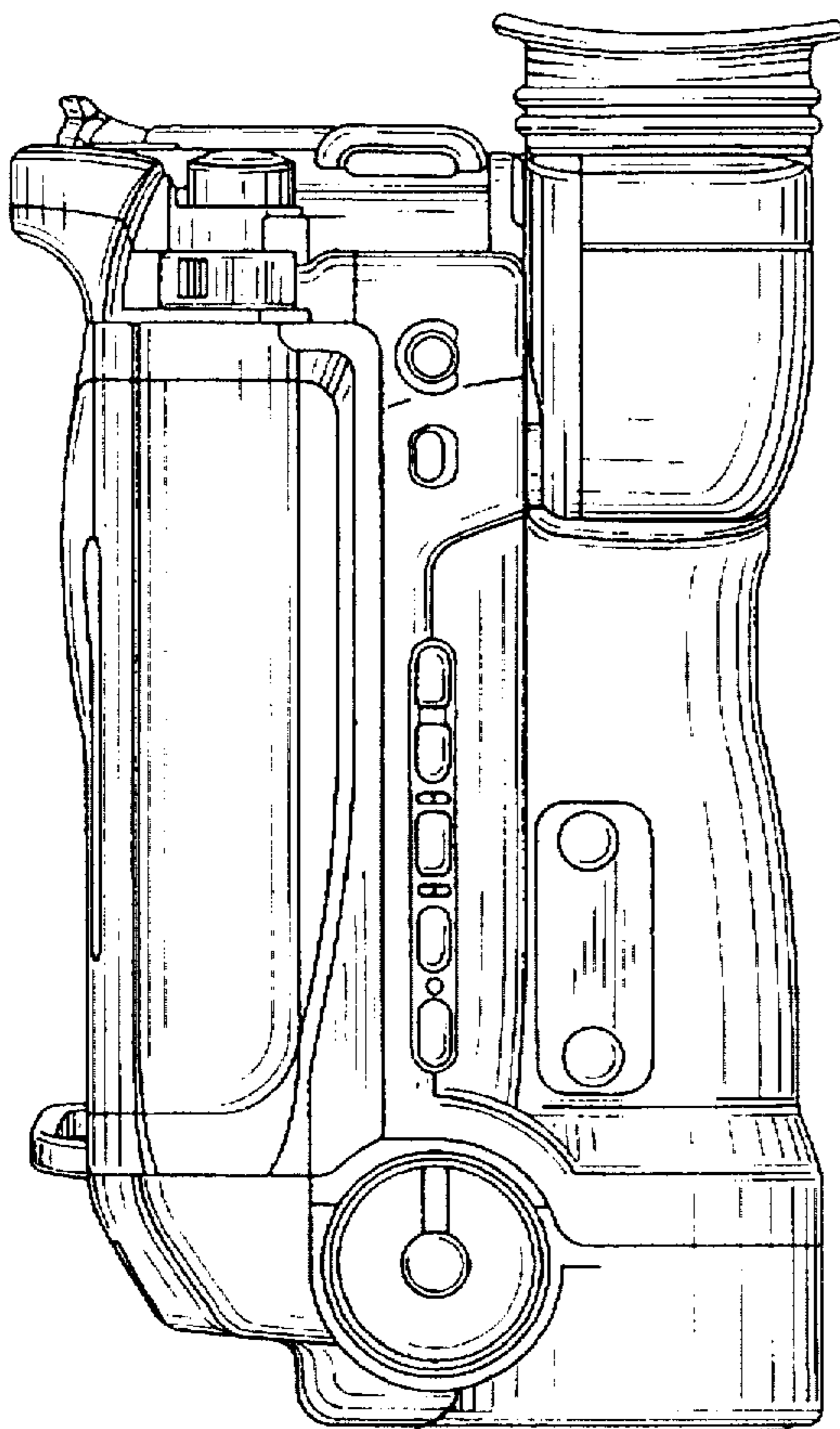

FIG. 4

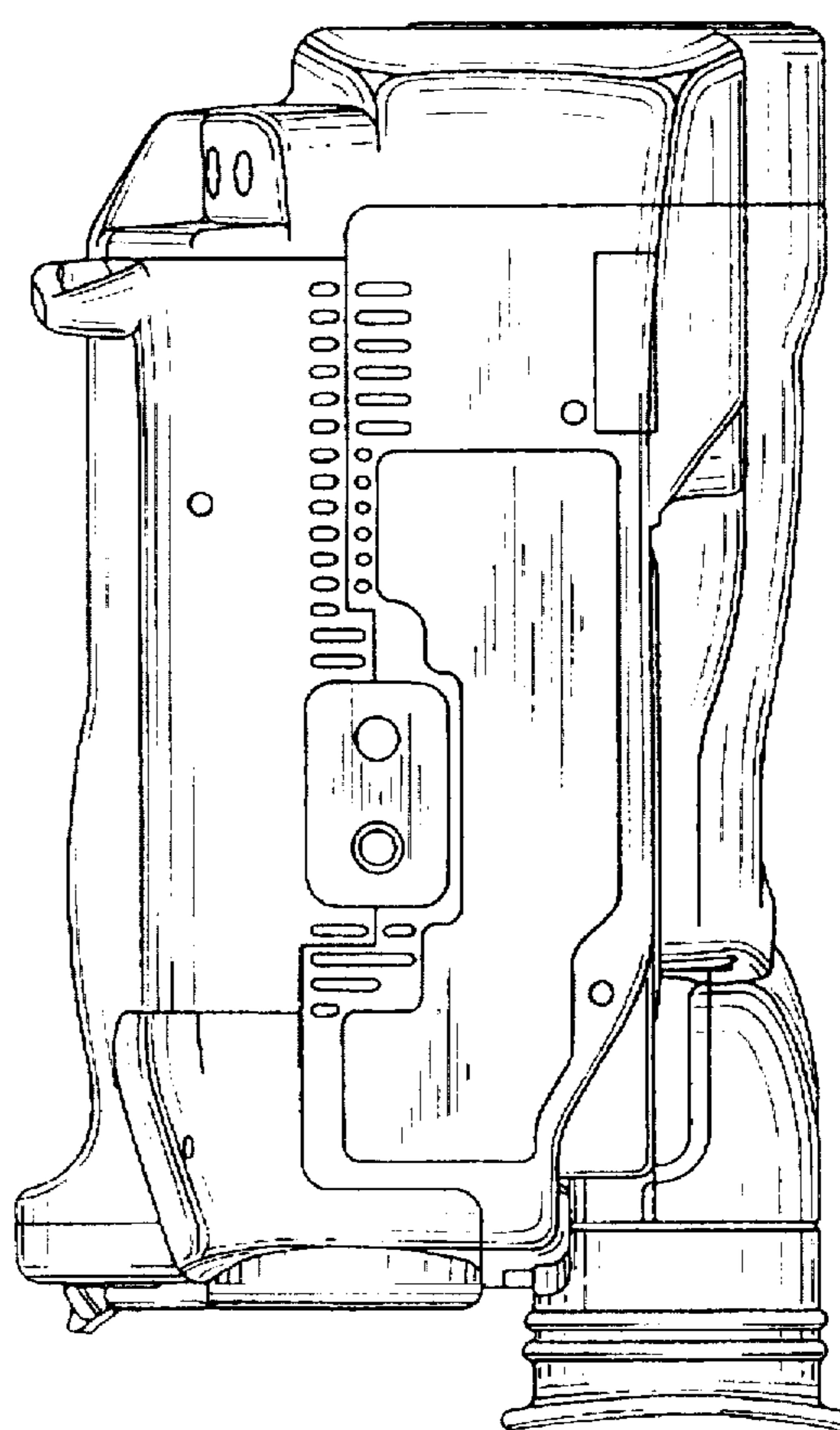



FIG. 5

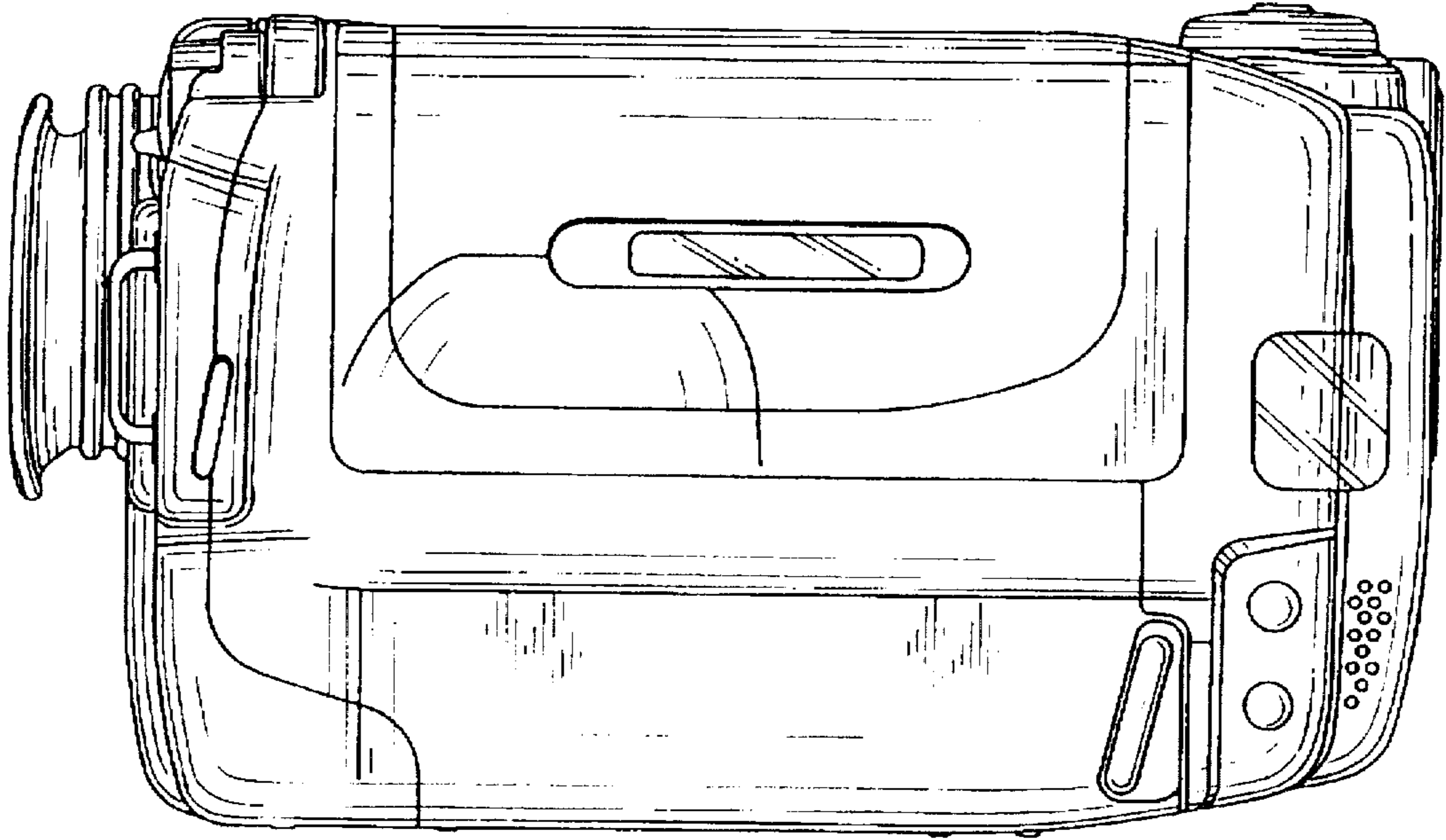

FIG. 6

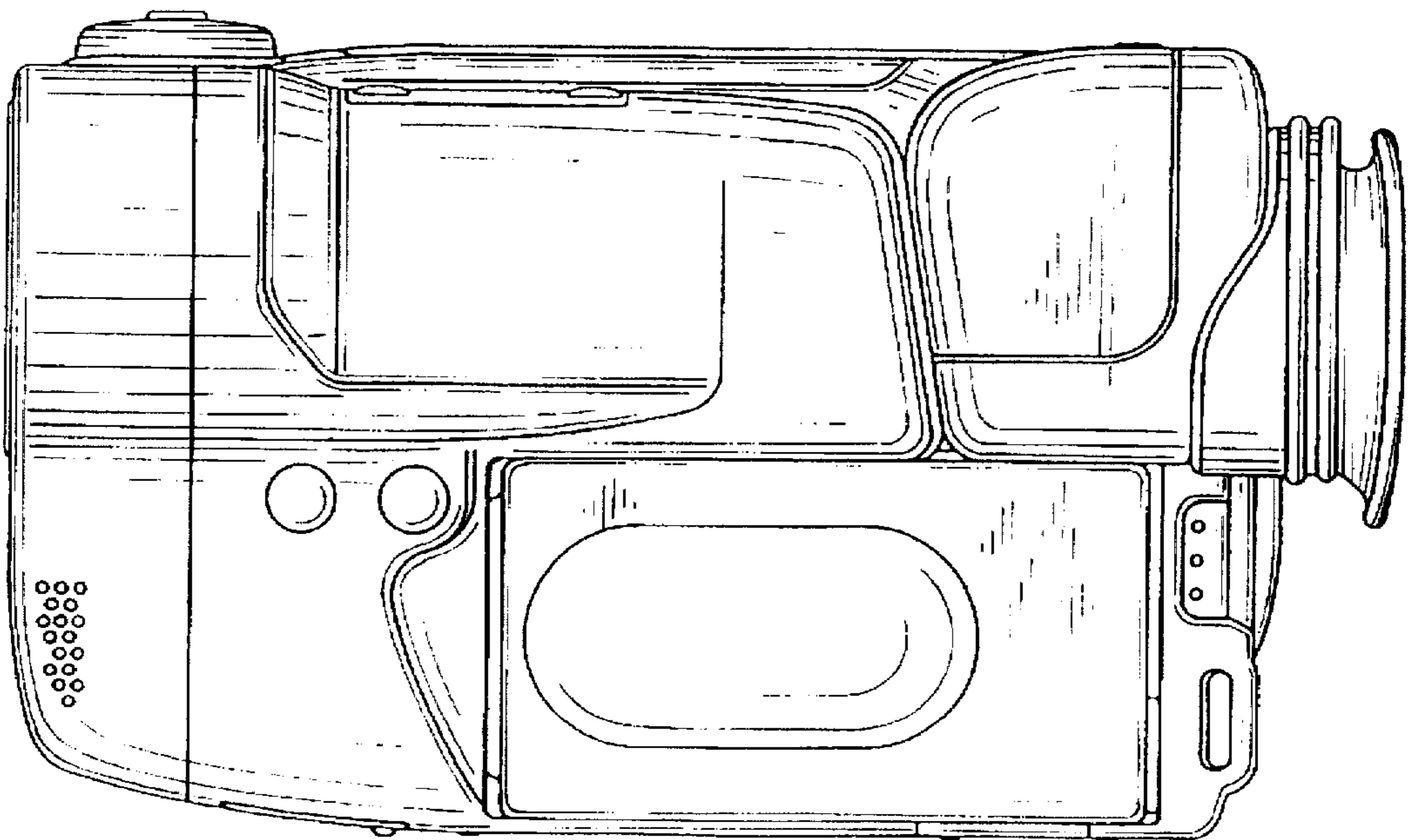

FIG. 7

