



US00D386491S

United States Patent [19]
Masamitsu

[11] **Patent Number: Des. 386,491**
[45] **Date of Patent: **Nov. 18, 1997**

[54] **MAGNET OPTICAL DISC RECORDER**

[75] **Inventor: Satoshi Masamitsu, Tokyo, Japan**

[73] **Assignee: Sony Corporation, Tokyo, Japan**

[**] **Term: 14 Years**

[21] **Appl. No.: 46,511**

[22] **Filed: Nov. 17, 1995**

[30] **Foreign Application Priority Data**

May 18, 1995 [JP] Japan 7-13627

[51] **LOC (6) Cl. 14-01**

[52] **U.S. Cl. D14/136; D14/165**

[58] **Field of Search D14/124, 135,
D14/136, 141, 156, 160, 239, 299, 163-165;
D13/184**

[56] **References Cited**

U.S. PATENT DOCUMENTS

- D. 305,762 1/1990 Yoda et al. D14/163
- D. 314,574 2/1991 Kato D14/163
- D. 350,748 9/1994 Sakata et al. D14/136 X

Primary Examiner—Prabhakar G. Deshmukh
Assistant Examiner—Richelle Shelton
Attorney, Agent, or Firm—Foley & Lardner

[57] **CLAIM**

The ornamental design for a magnet optical disc recorder, as shown and described.

DESCRIPTION

FIG. 1 is a perspective view of the magnet optical disc recorder showing my new design;
 FIG. 2 is a top plan view thereof;
 FIG. 3 is a left side elevational view thereof;
 FIG. 4 is a front elevational view thereof;
 FIG. 5 is a bottom plan view thereof;
 FIG. 6 is a right side elevational view thereof;
 FIG. 7 is a rear elevational view thereof;
 FIG. 8 is a perspective view of another embodiment of a magnet optical disc recorder showing my new design;
 FIG. 9 is a top plan view of the embodiment of FIG. 8;
 FIG. 10 is a left side elevational view of the embodiment of FIG. 8;
 FIG. 11 is a front elevational view of the embodiment of FIG. 8;
 FIG. 12 is a bottom plan view of the embodiment of FIG. 8;
 FIG. 13 is a right side elevational view of the embodiment of FIG. 8; and,
 FIG. 14 is a rear elevational view of the embodiment of FIG. 8.

1 Claim, 6 Drawing Sheets

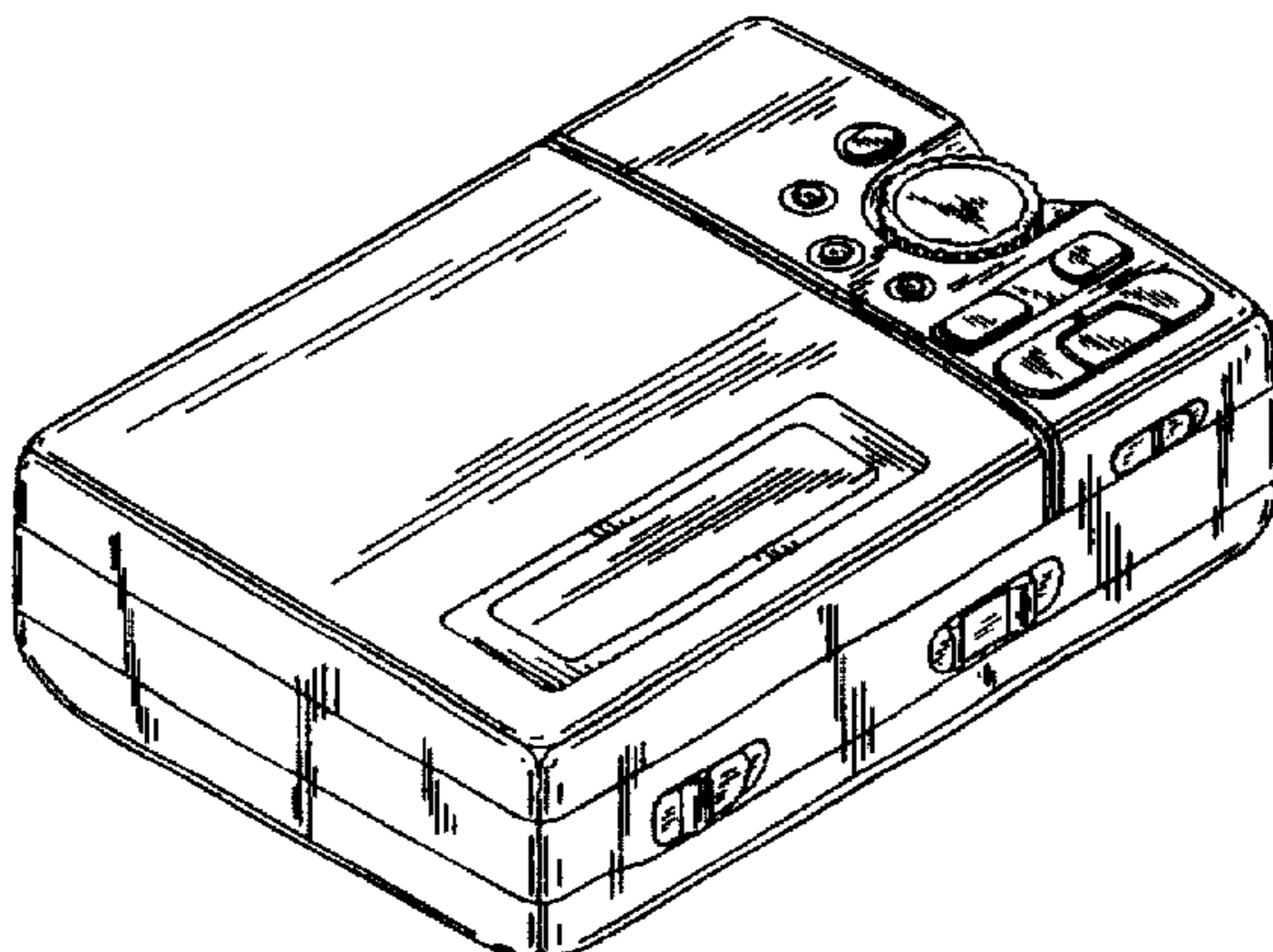
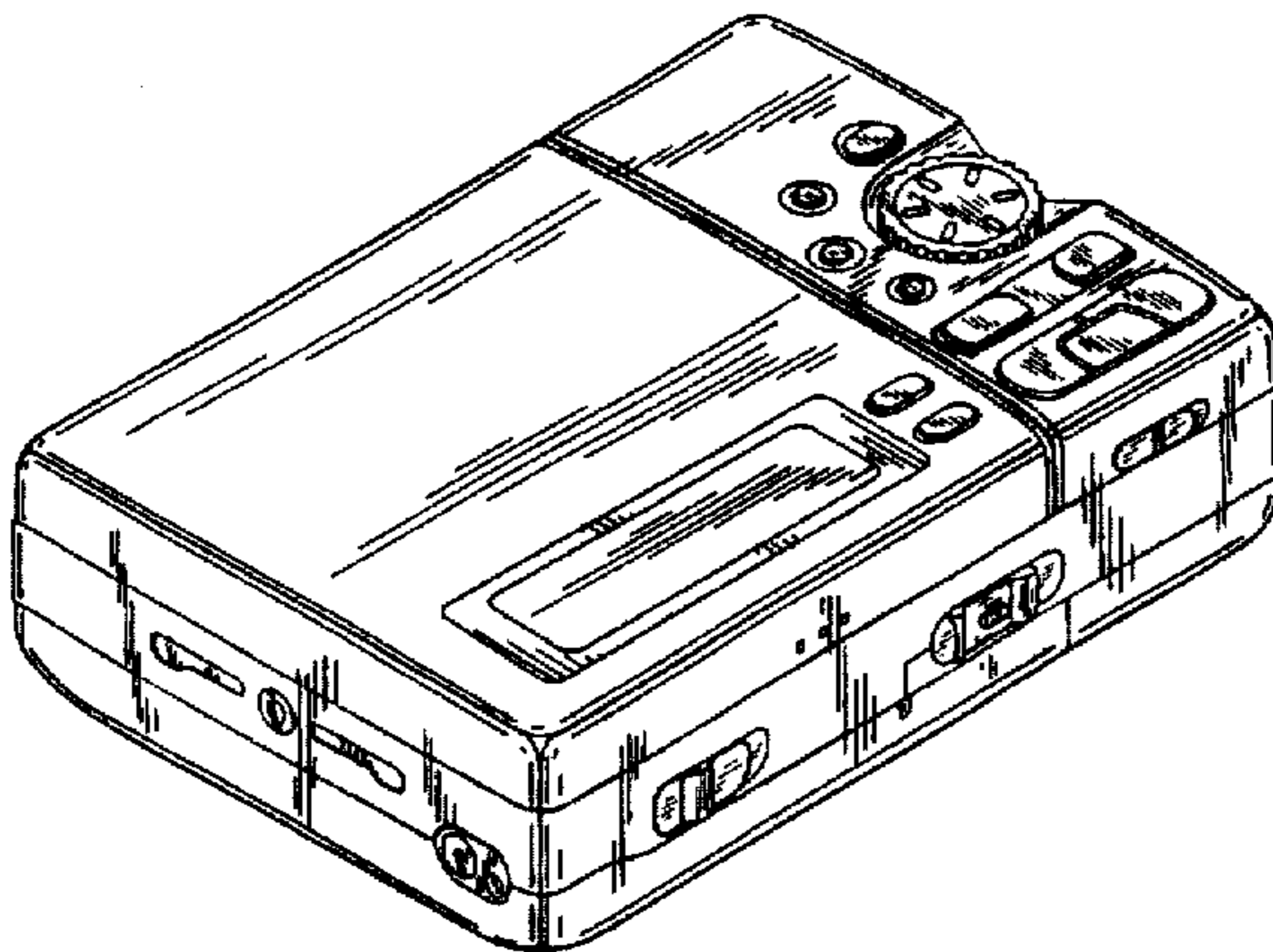

FIG. 1

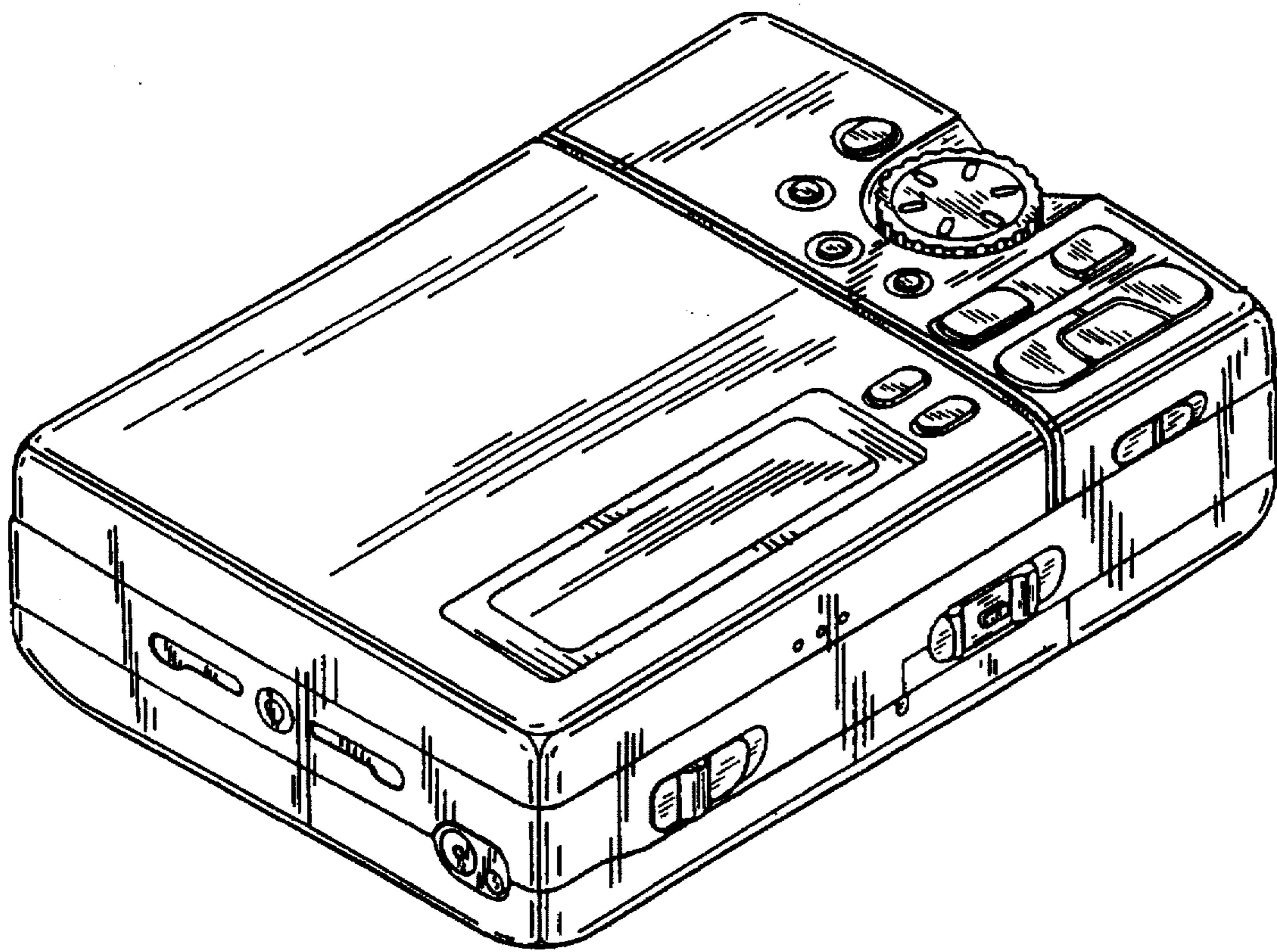

FIG. 2

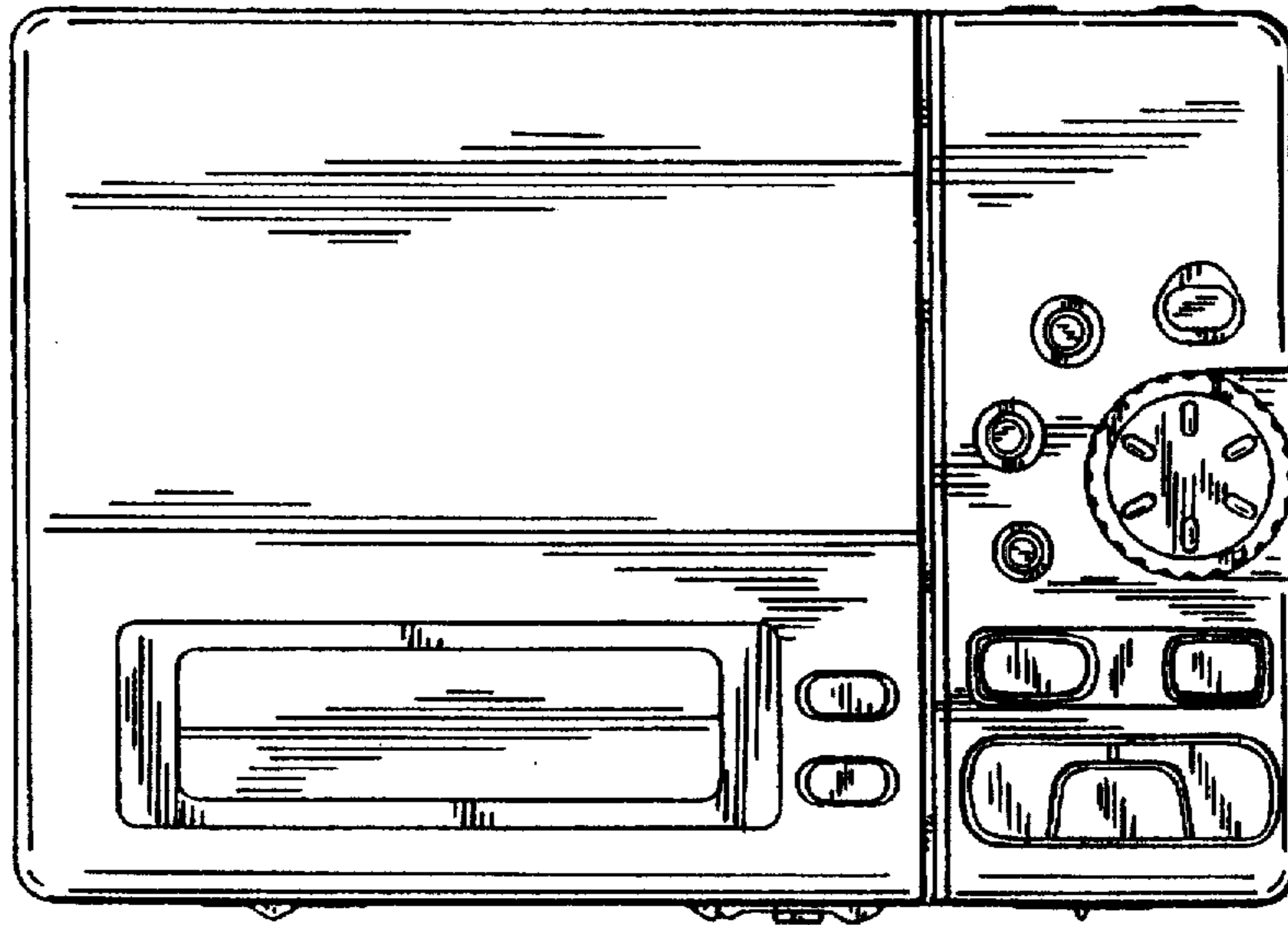

FIG. 3

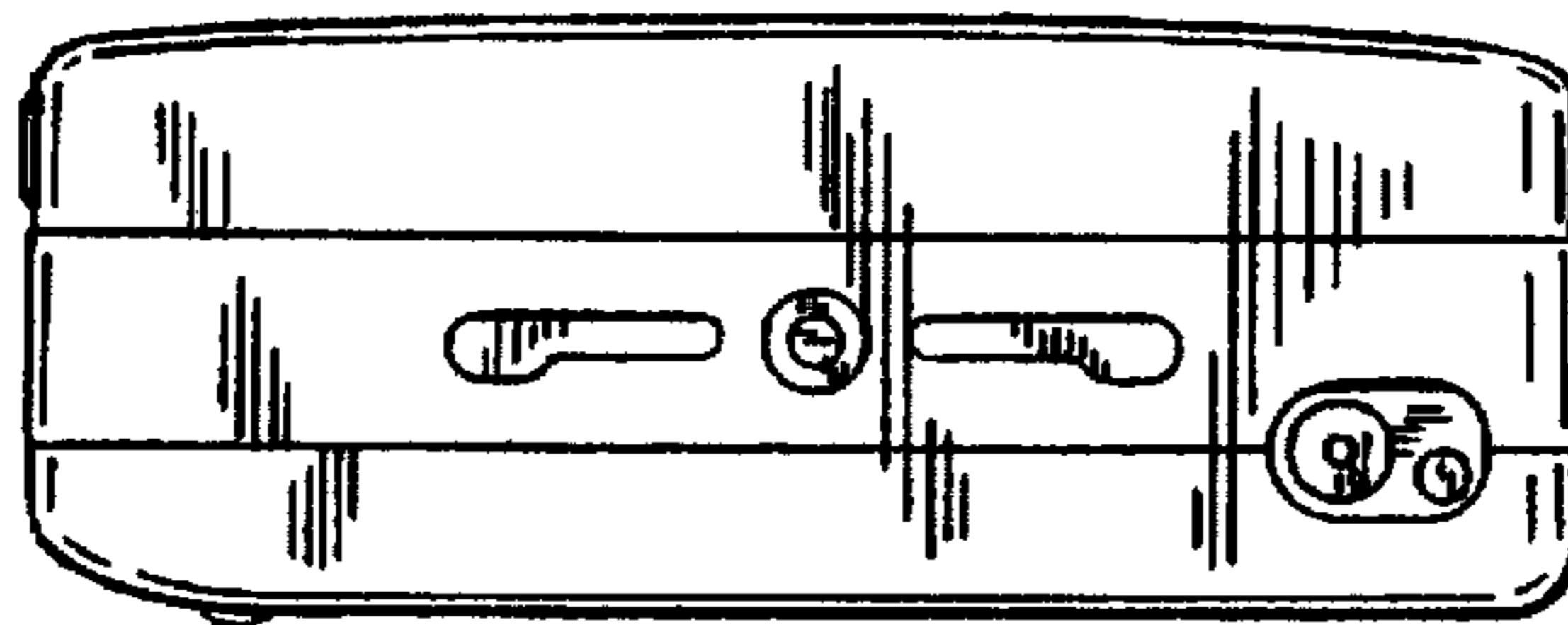

FIG. 4

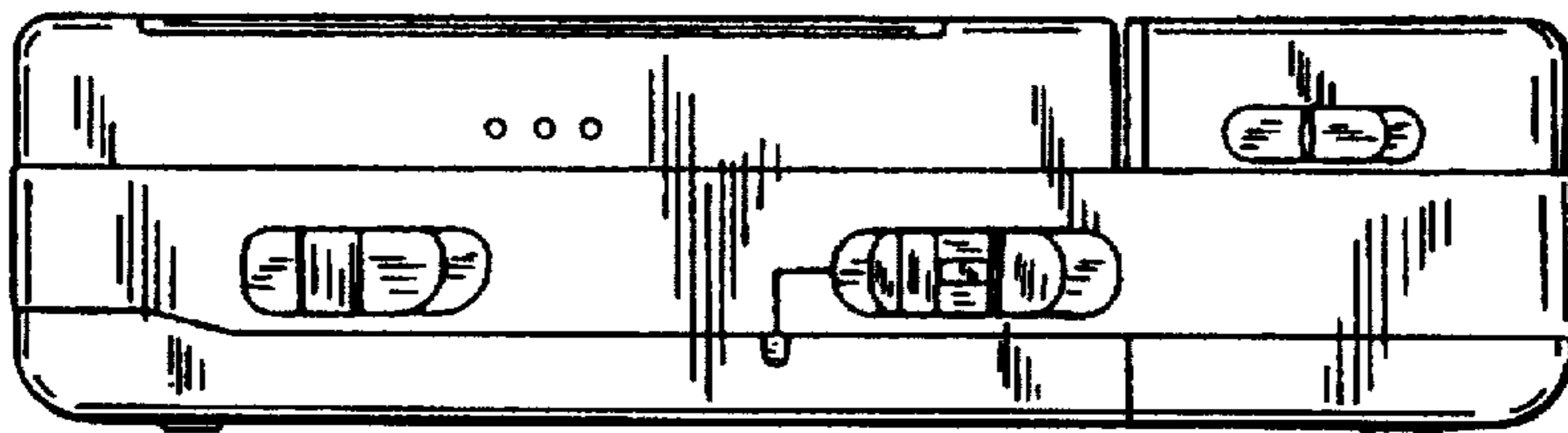

FIG. 5

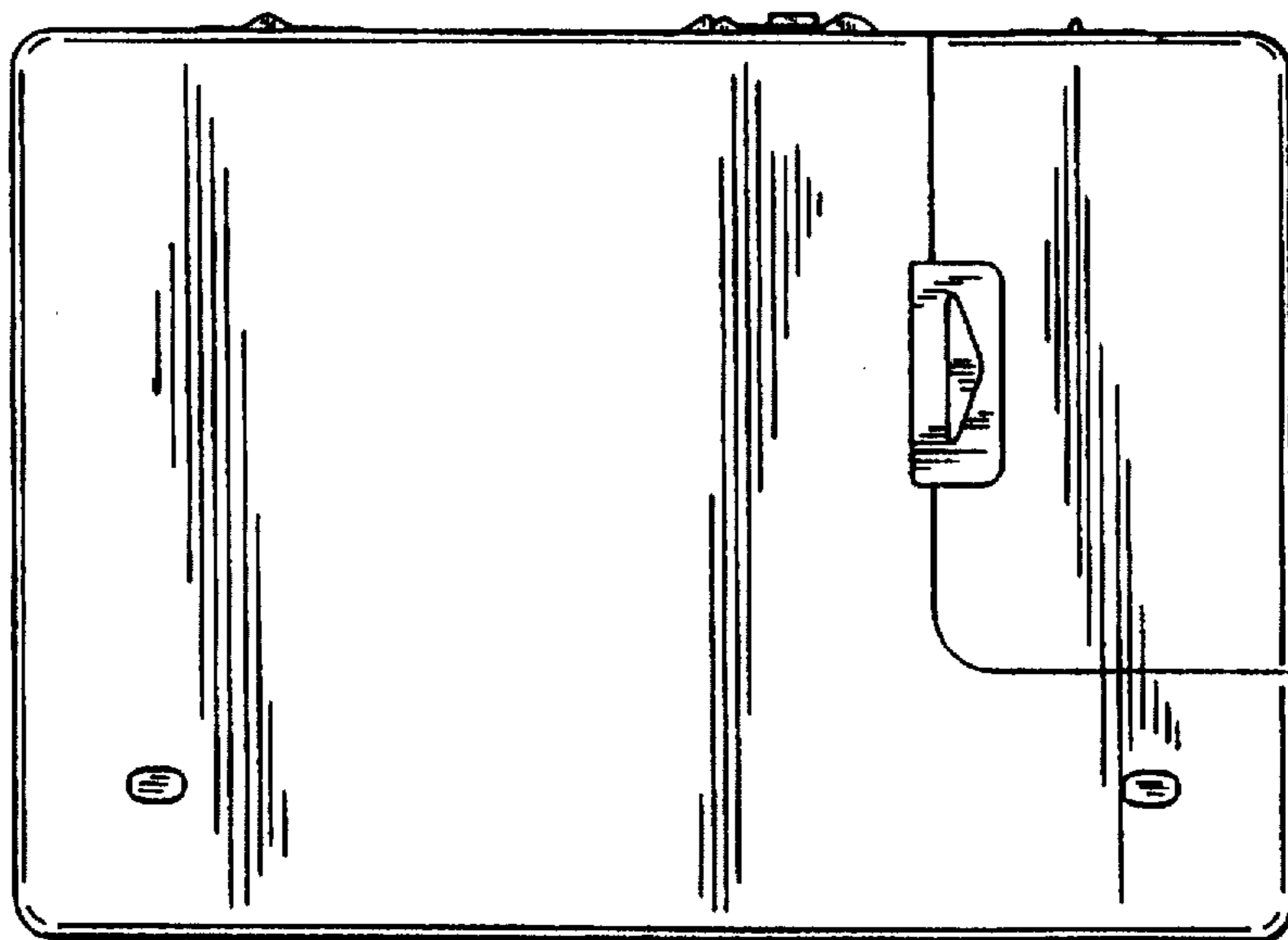

FIG. 6

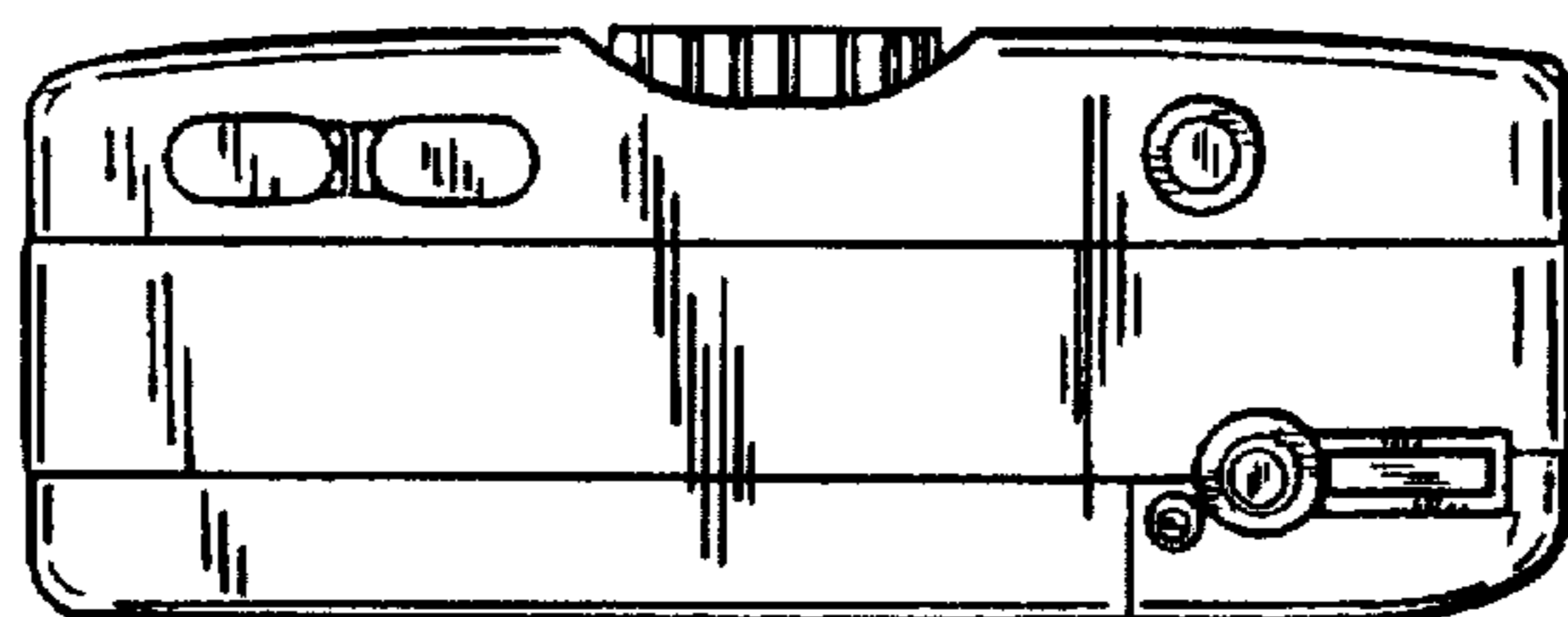

FIG. 7

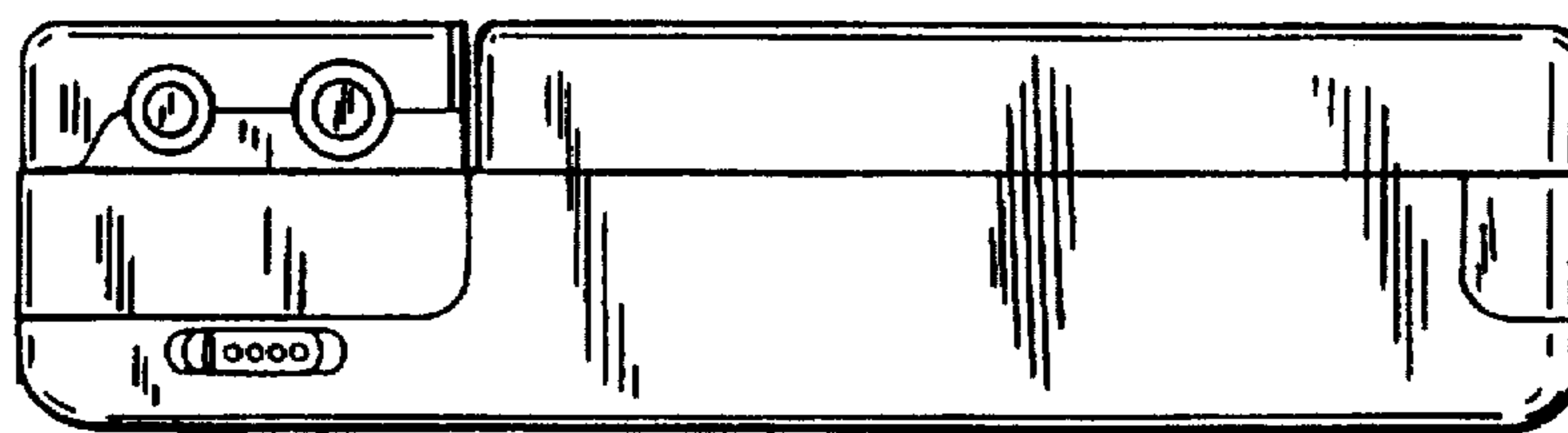

FIG. 8

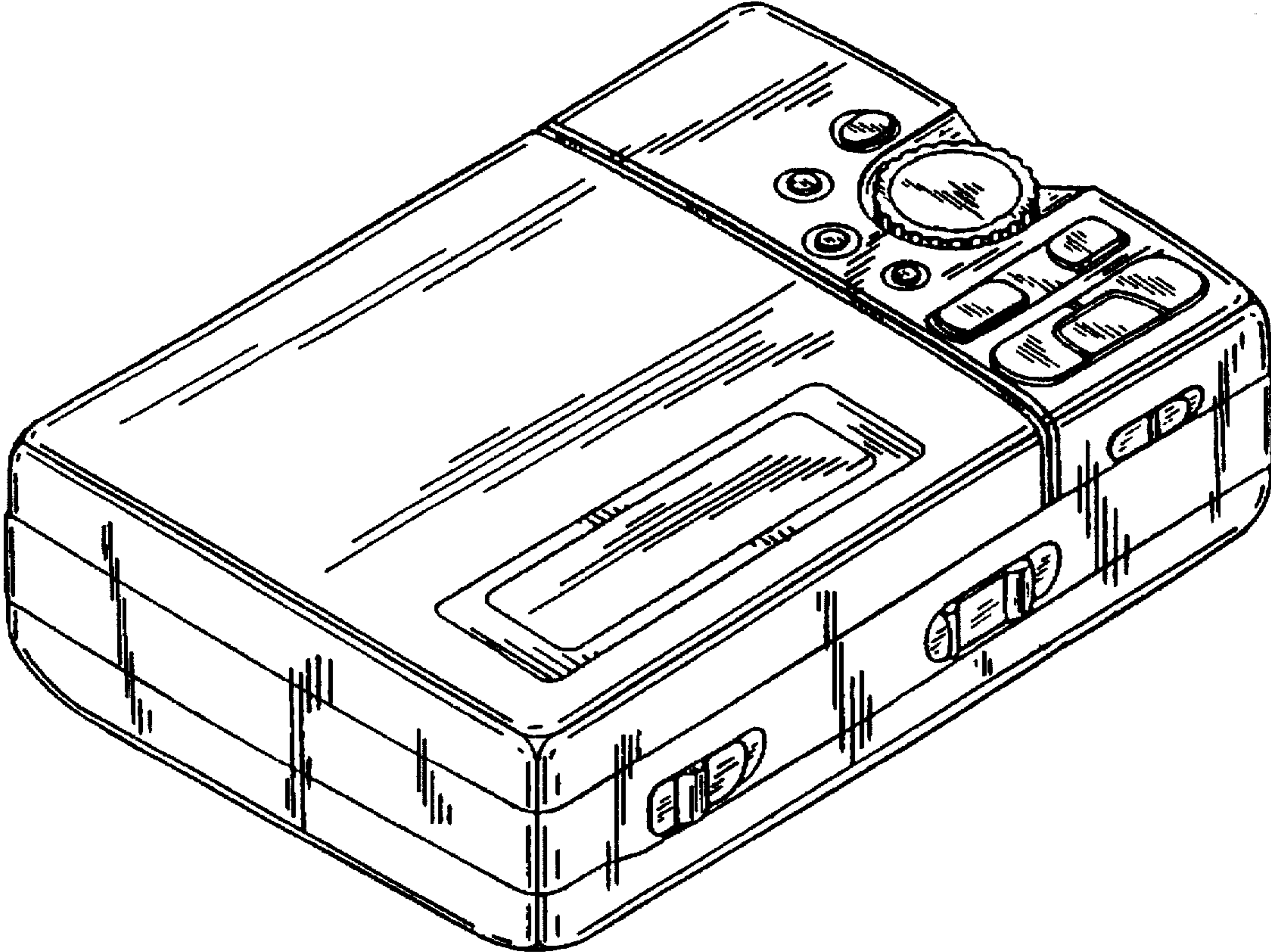

FIG. 9

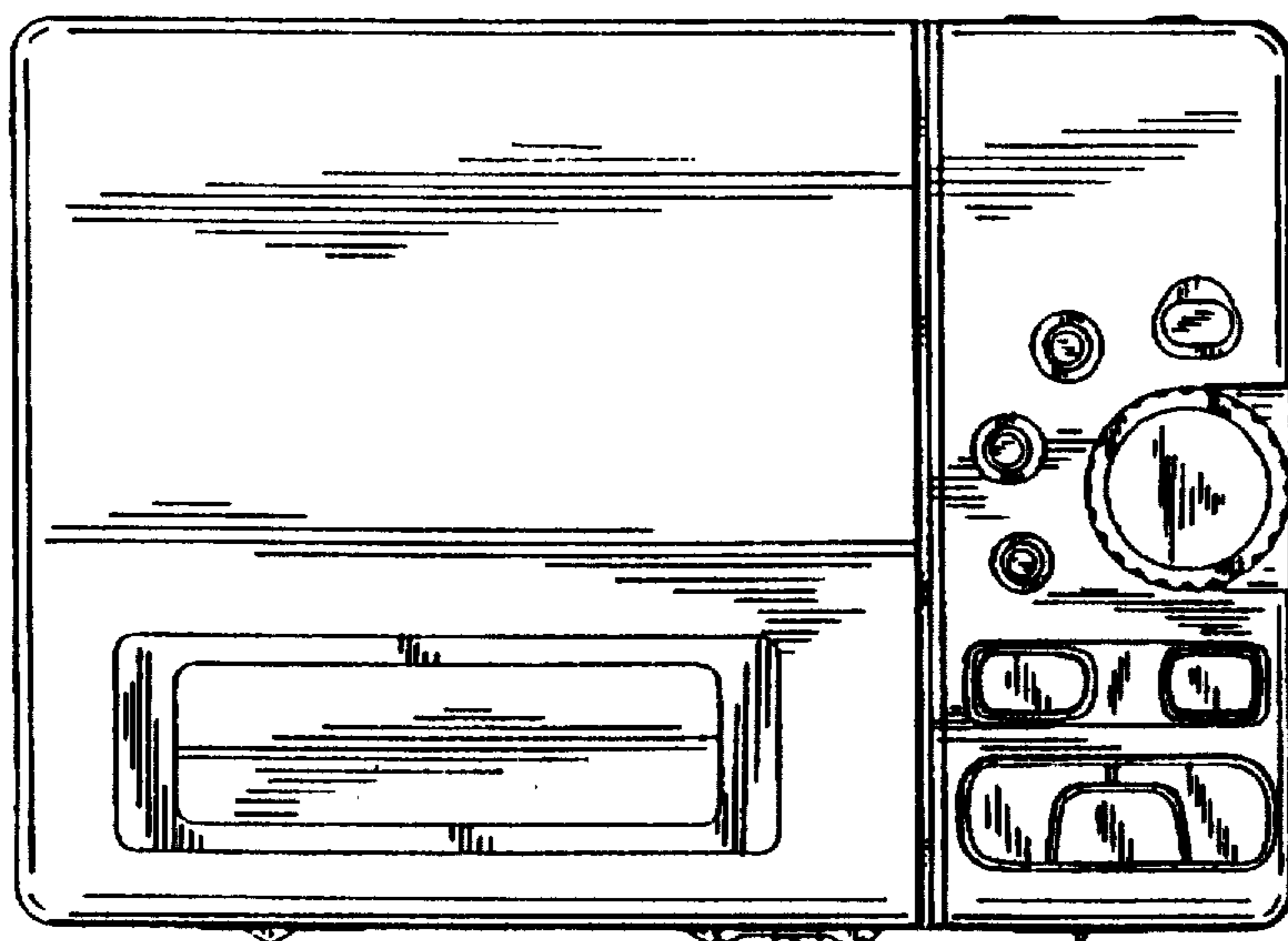

FIG. 10

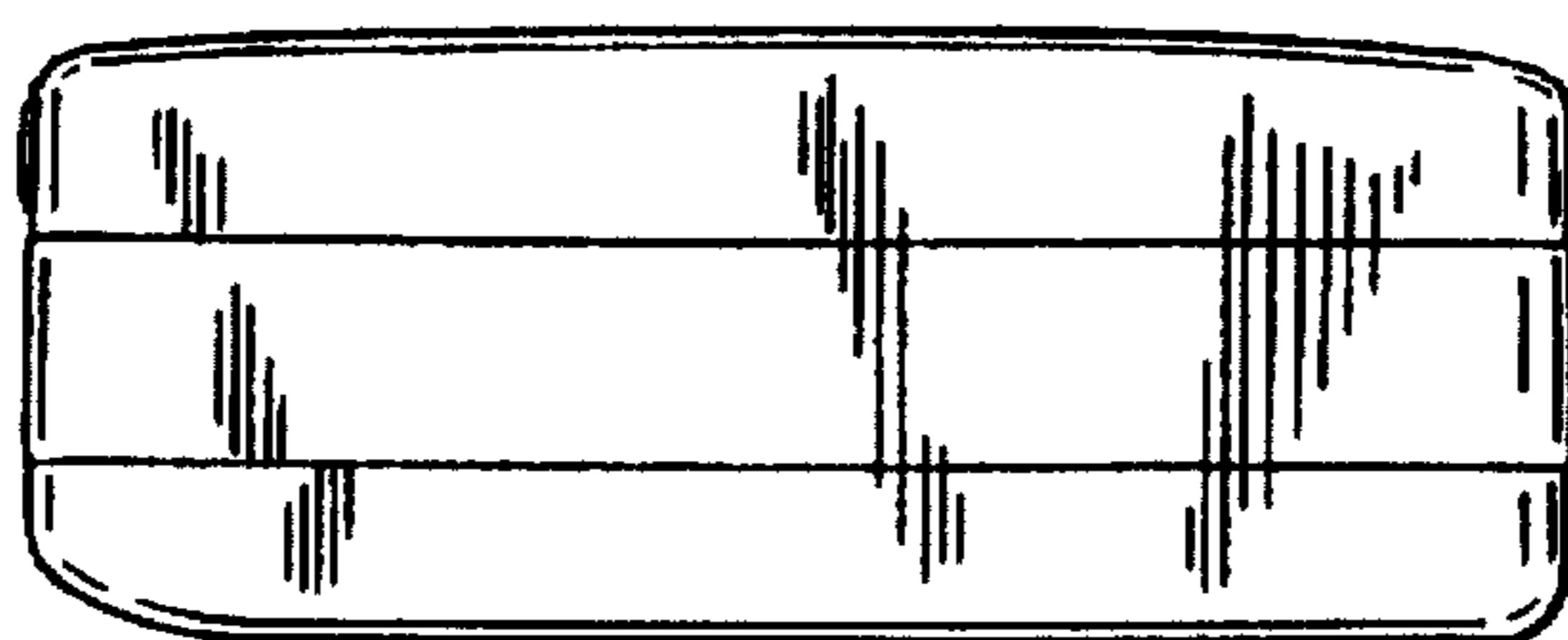

FIG. 11

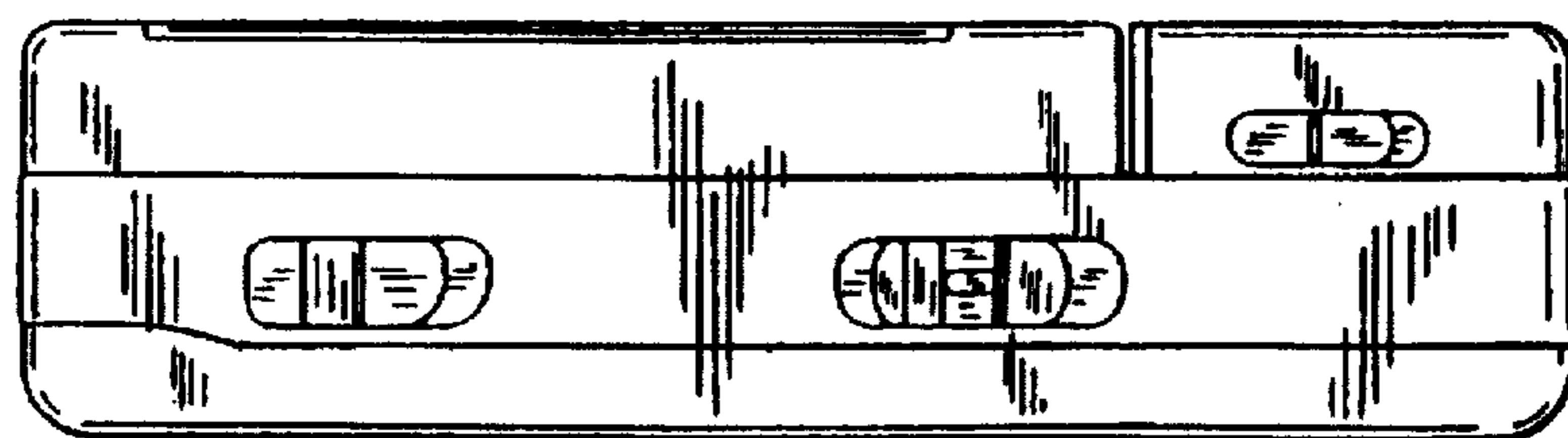

FIG. 12

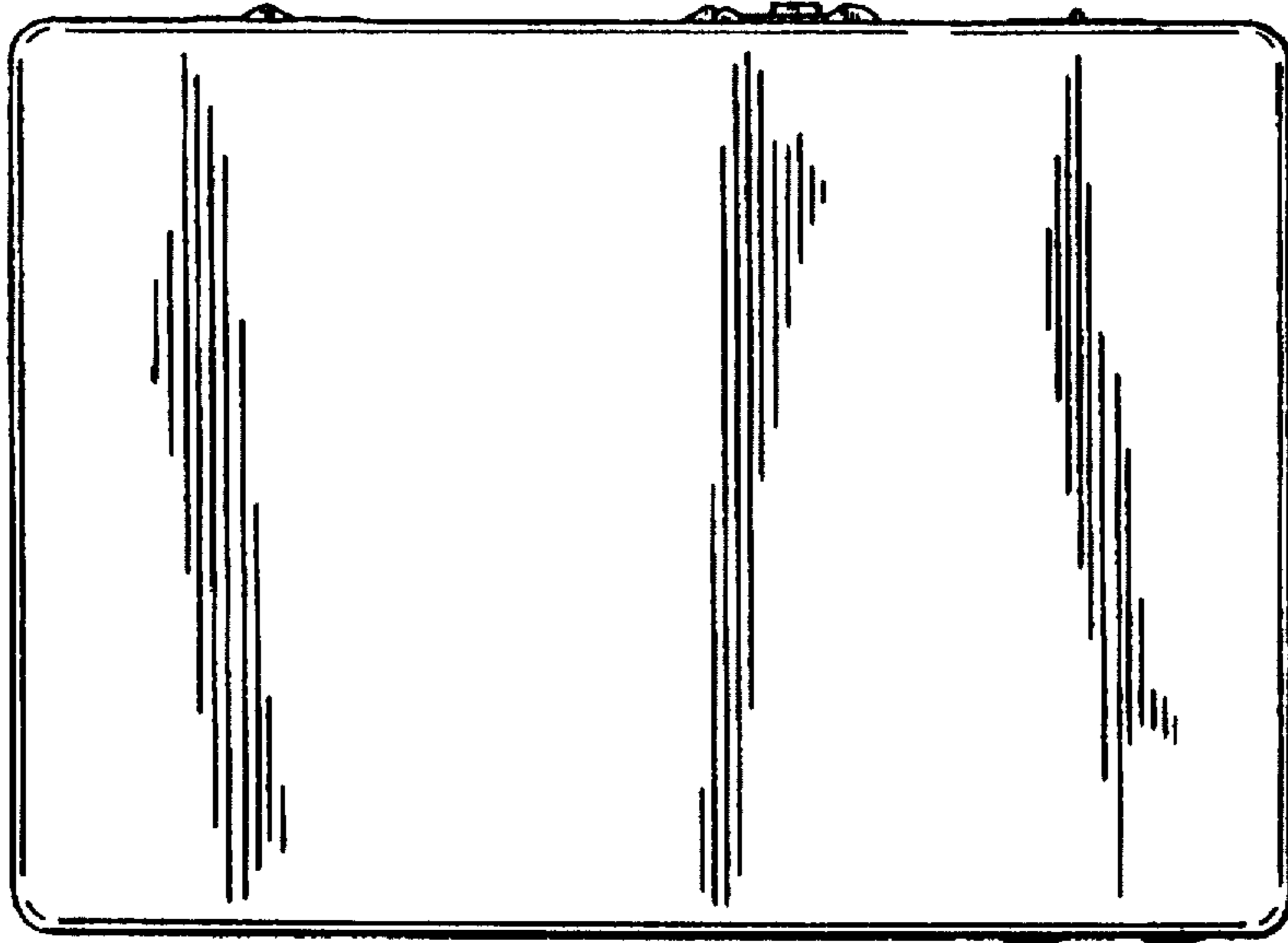

FIG. 13

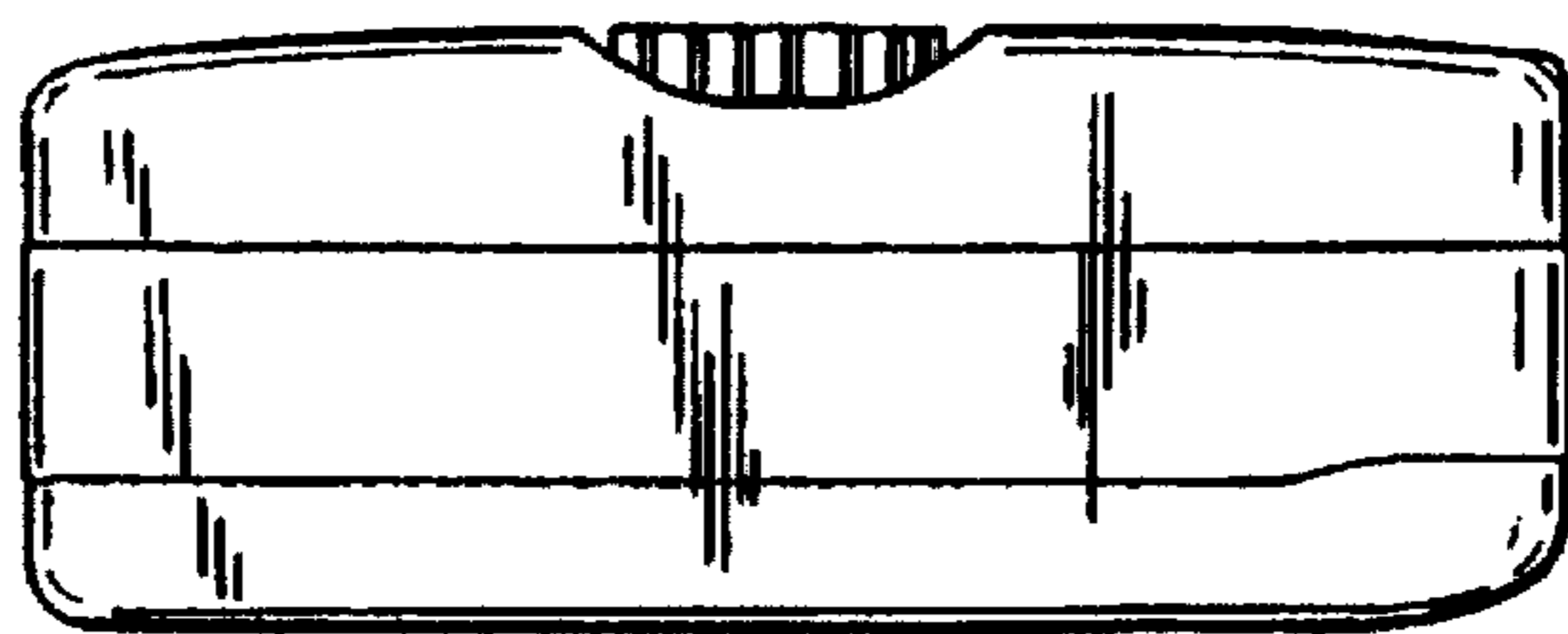

FIG. 14

