



US00D386480S

United States Patent [19]

[11] **Patent Number: Des. 386,480**

Daly et al.

[45] **Date of Patent: **Nov. 18, 1997**

[54] **NOTEBOOK COMPUTER**

Attorney, Agent, or Firm—Knobbe, Martens, Olson & Bear, LLP

[75] **Inventors: John J. Daly, Irvine; Max Yoshimoto, San Francisco; Jeffrey Salazar, Belmont, all of Calif.; Chia-Chun Lee, Taipei, Taiwan**

[57] **CLAIM**

The ornamental design for a notebook computer, as shown and described.

[73] **Assignee: AST Research, Inc., Irvine, Calif.**

DESCRIPTION

[**] **Term: 14 Years**

FIG. 1 is a front perspective view of the notebook computer in an open position;

[21] **Appl. No.: 52,325**

FIG. 2 is a front elevational view of the design of FIG. 1;

[22] **Filed: Apr. 2, 1996**

FIG. 3 is a rear elevational view of the design of FIG. 1;

[51] **LOC (6) Cl. 14-02**

FIG. 4 is a left side elevational view of the design of FIG. 1;

[52] **U.S. Cl. D14/106**

FIG. 5 is a right side elevational view of the design of FIG. 1;

[58] **Field of Search D14/100, 101, D14/106, 113, 115; D18/1, 7, 11; 235/145 A, 145 R; 341/22, 23; 345/104, 156, 160, 168, 173, 167; 361/680-686; 364/708.1, 709.04, 709.12; 400/486, 489**

FIG. 6 is a top plan view of the design of FIG. 1;

FIG. 7 is a bottom plan view of the design of FIG. 1;

FIG. 8 is a front perspective view of the notebook computer of FIG. 1 in a closed position;

FIG. 9 is a front elevational view of the design of FIG. 8;

FIG. 10 is a rear elevational view of the design of FIG. 8;

FIG. 11 is a left side elevational view of the design of FIG. 8;

FIG. 12 is a right side elevational view of the design of FIG. 8;

FIG. 13 is a top plan view of the design of FIG. 8; and,

FIG. 14 is a bottom plan view of the design of FIG. 8.

[56] **References Cited**

U.S. PATENT DOCUMENTS

D. 360,622	7/1995	Shin et al.	D14/106
D. 361,553	8/1995	De Iuliis	D14/106
D. 364,150	11/1995	Mieki	D14/106
D. 368,470	4/1996	Kondo	D14/106

Primary Examiner—Freda Nunn

1 Claim, 8 Drawing Sheets

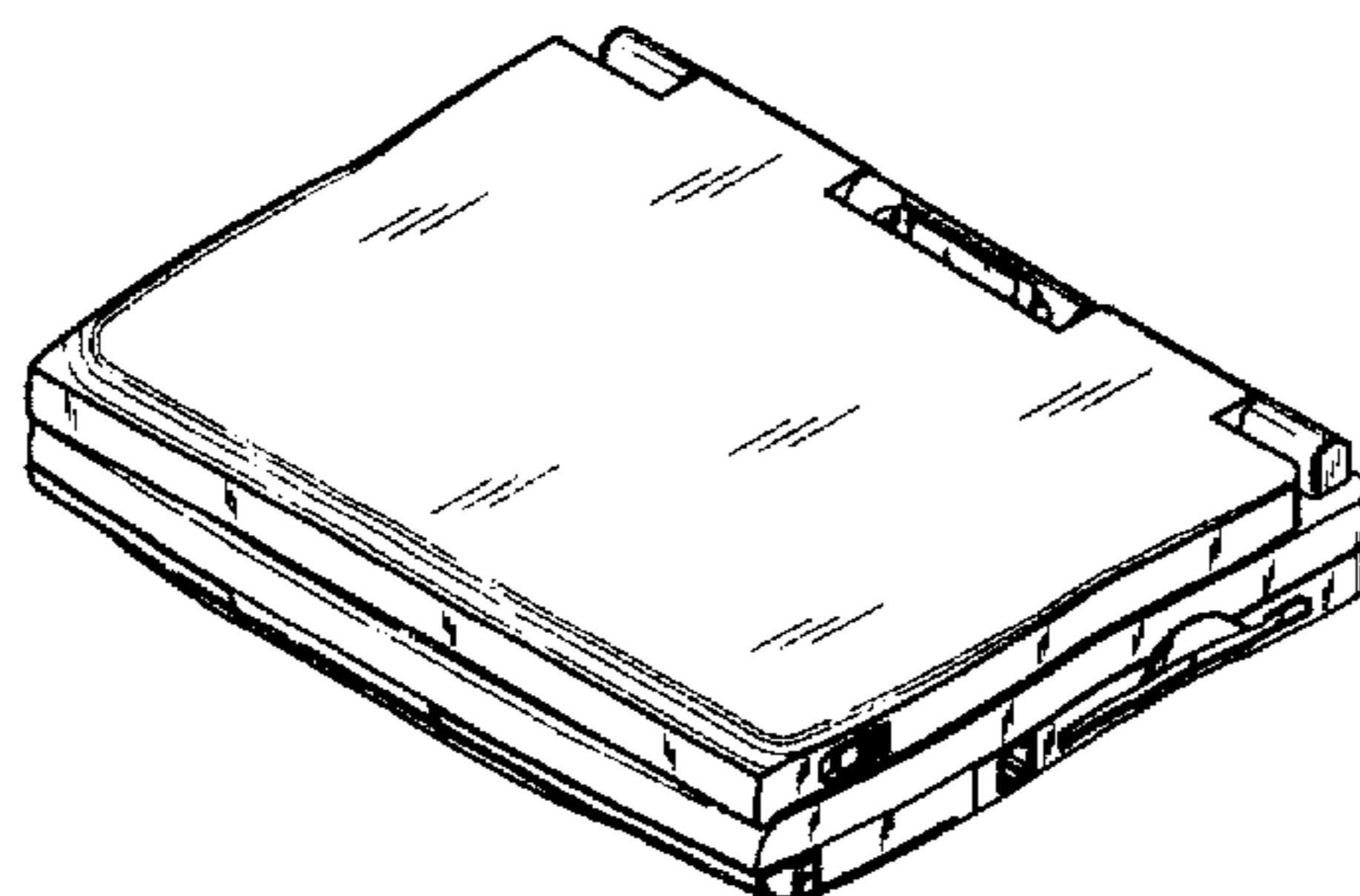
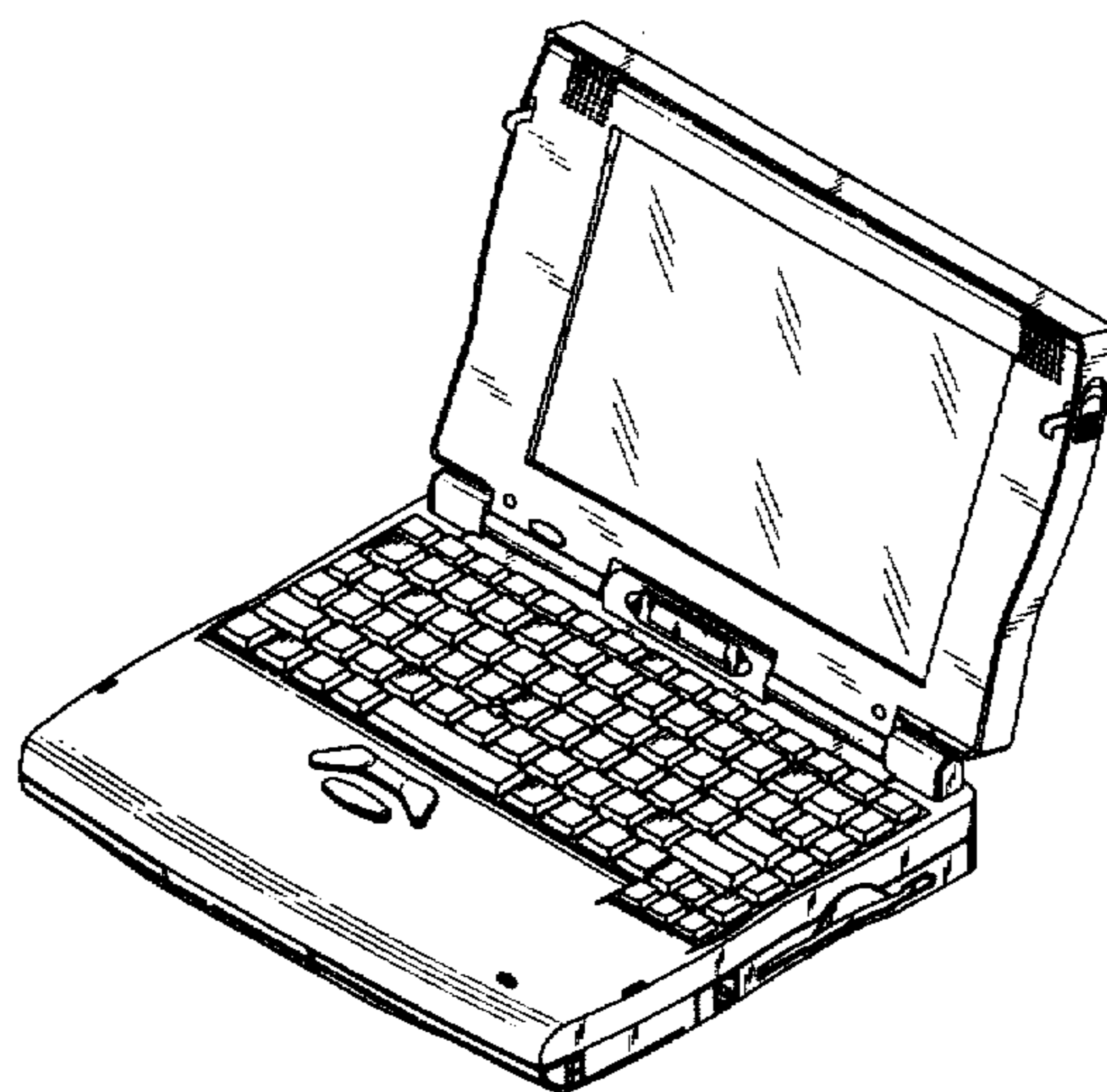

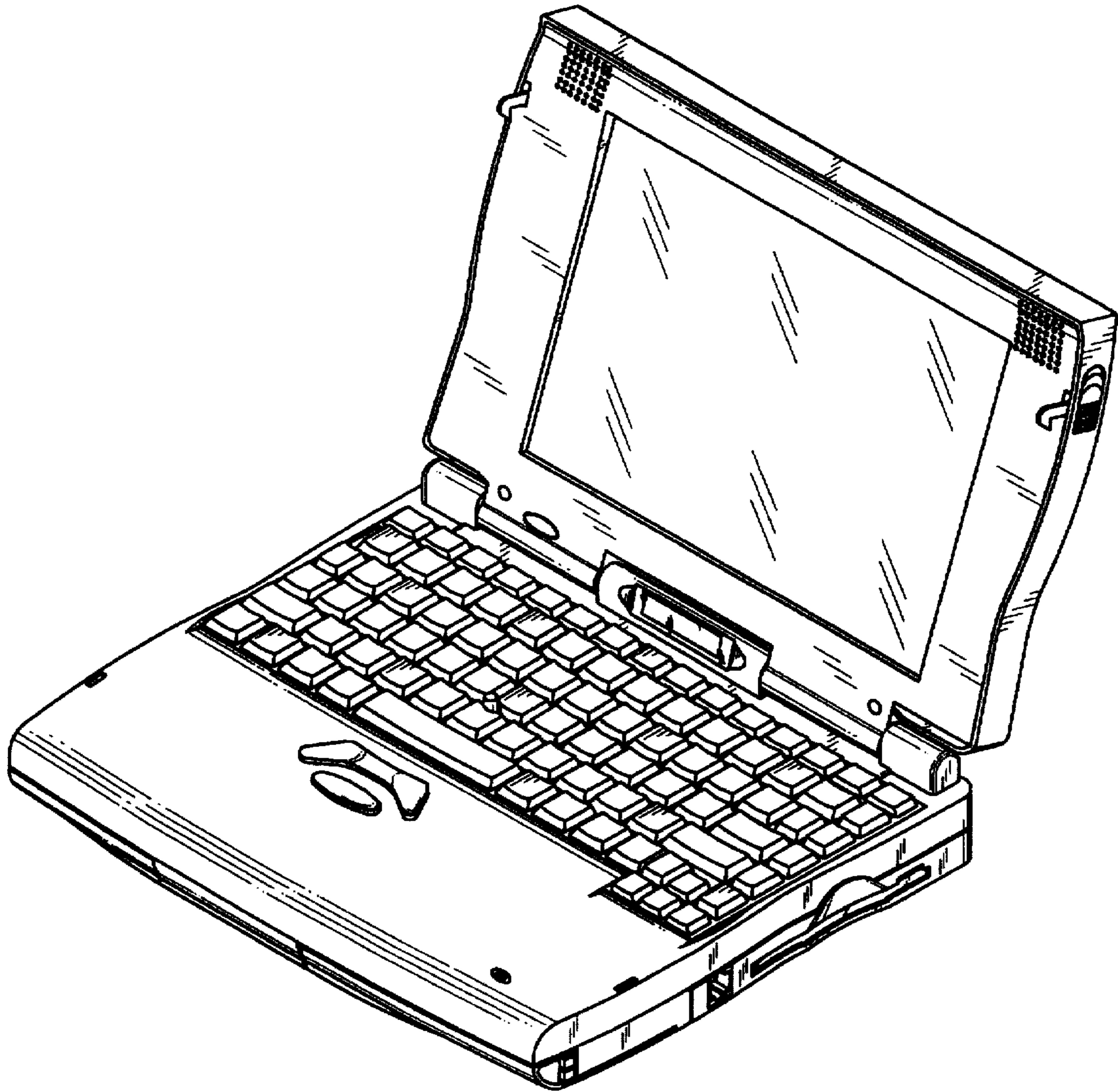

Fig. 1

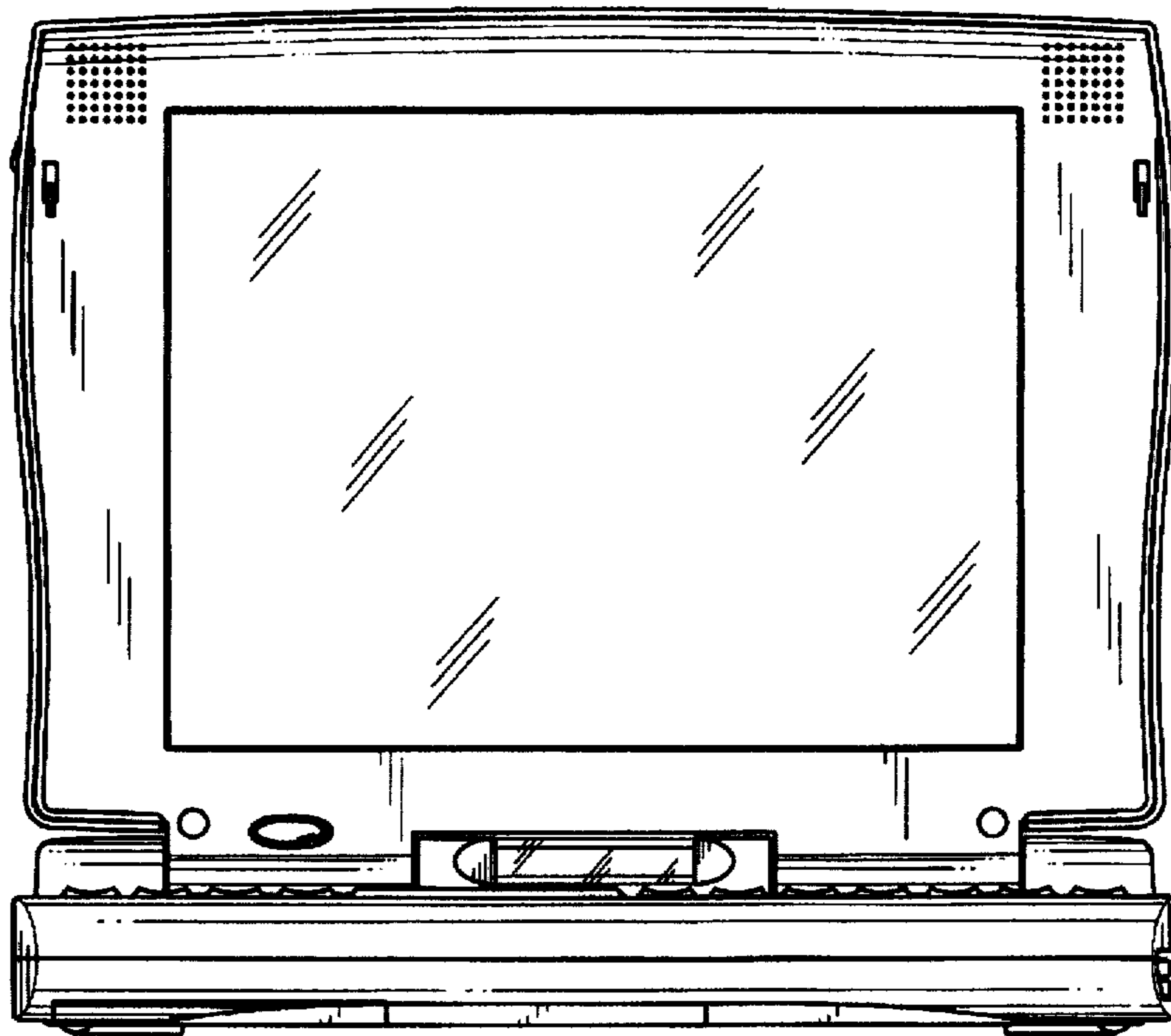

Fig. 2

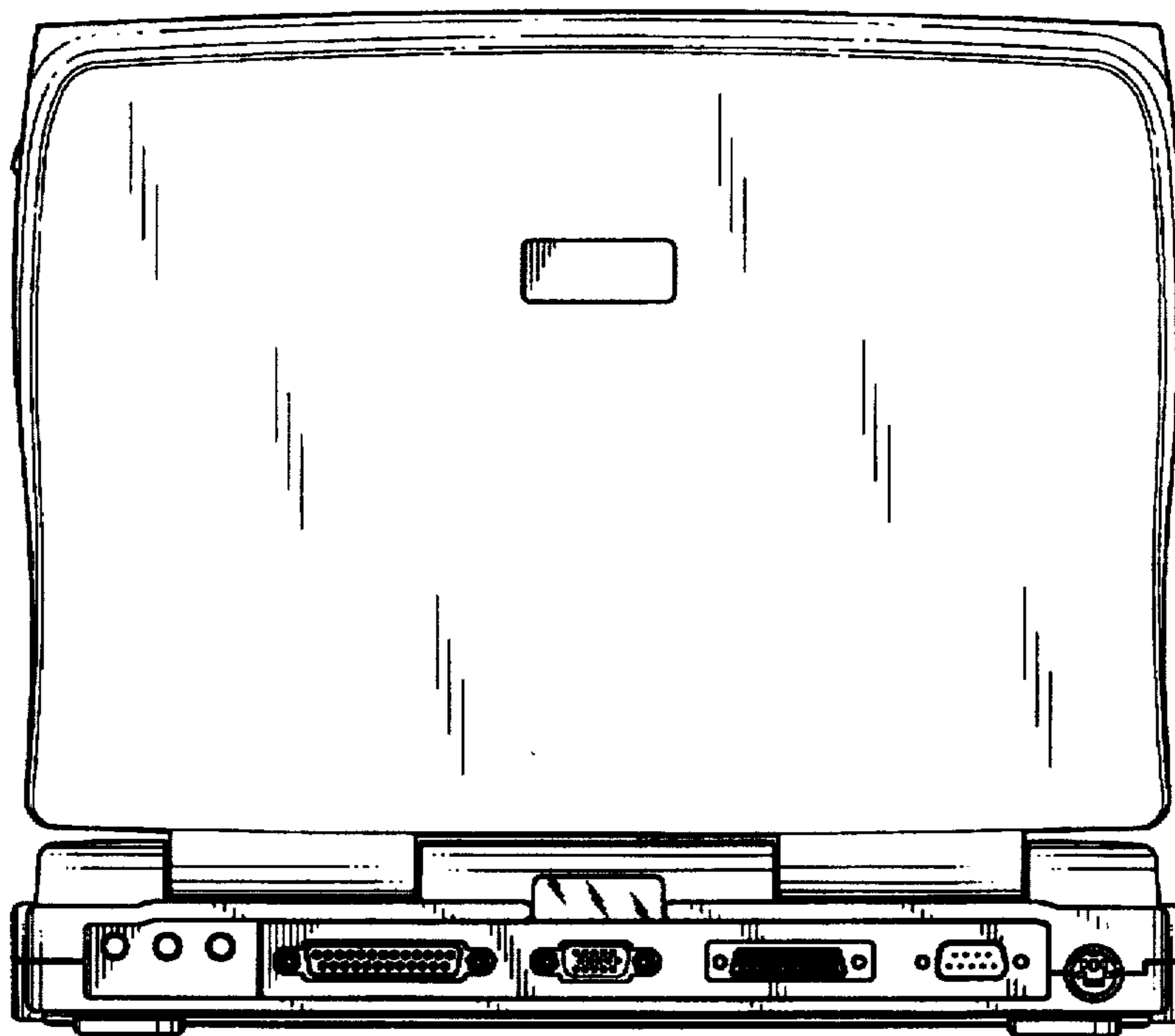

Fig. 3

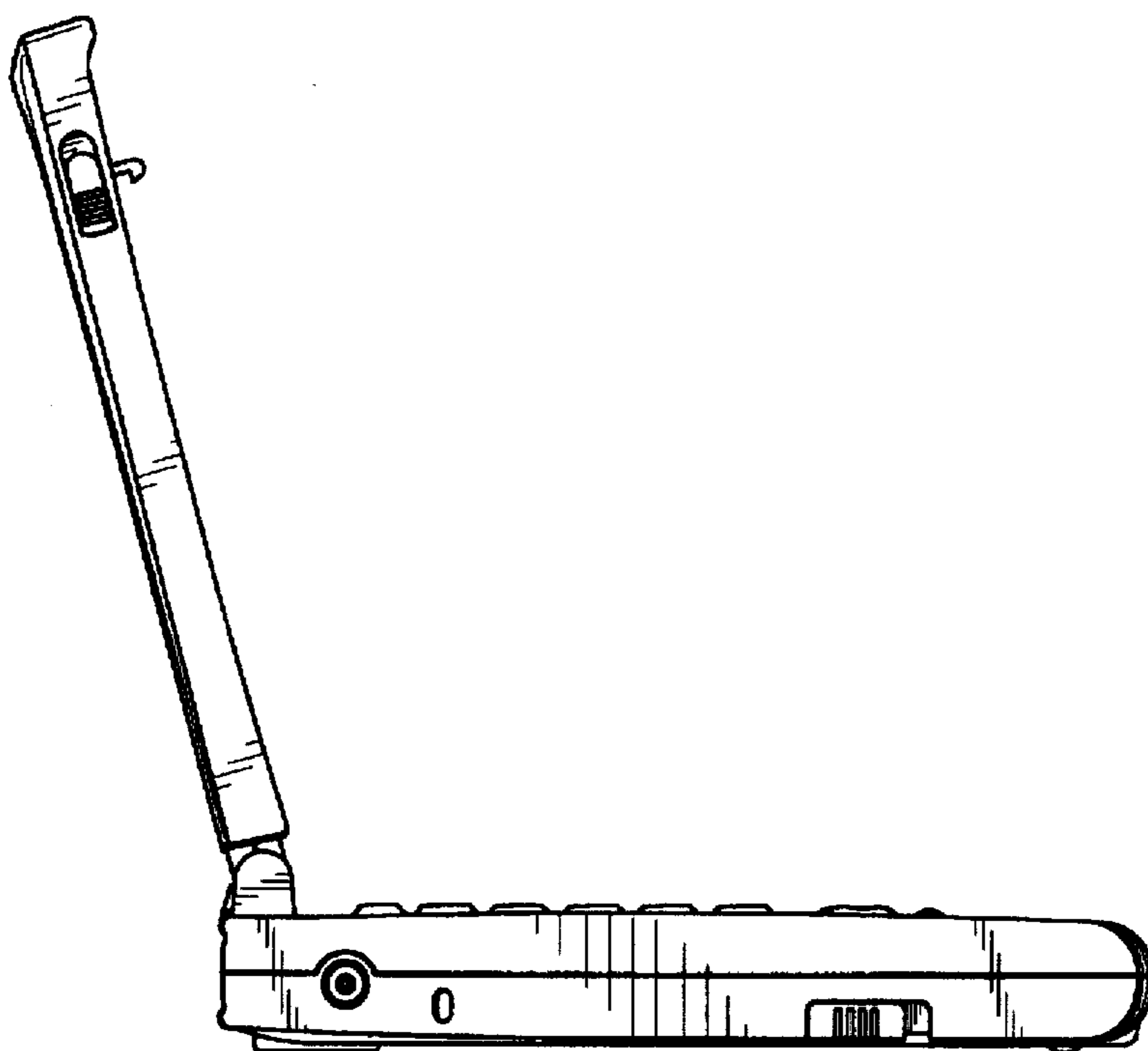

Fig. 4

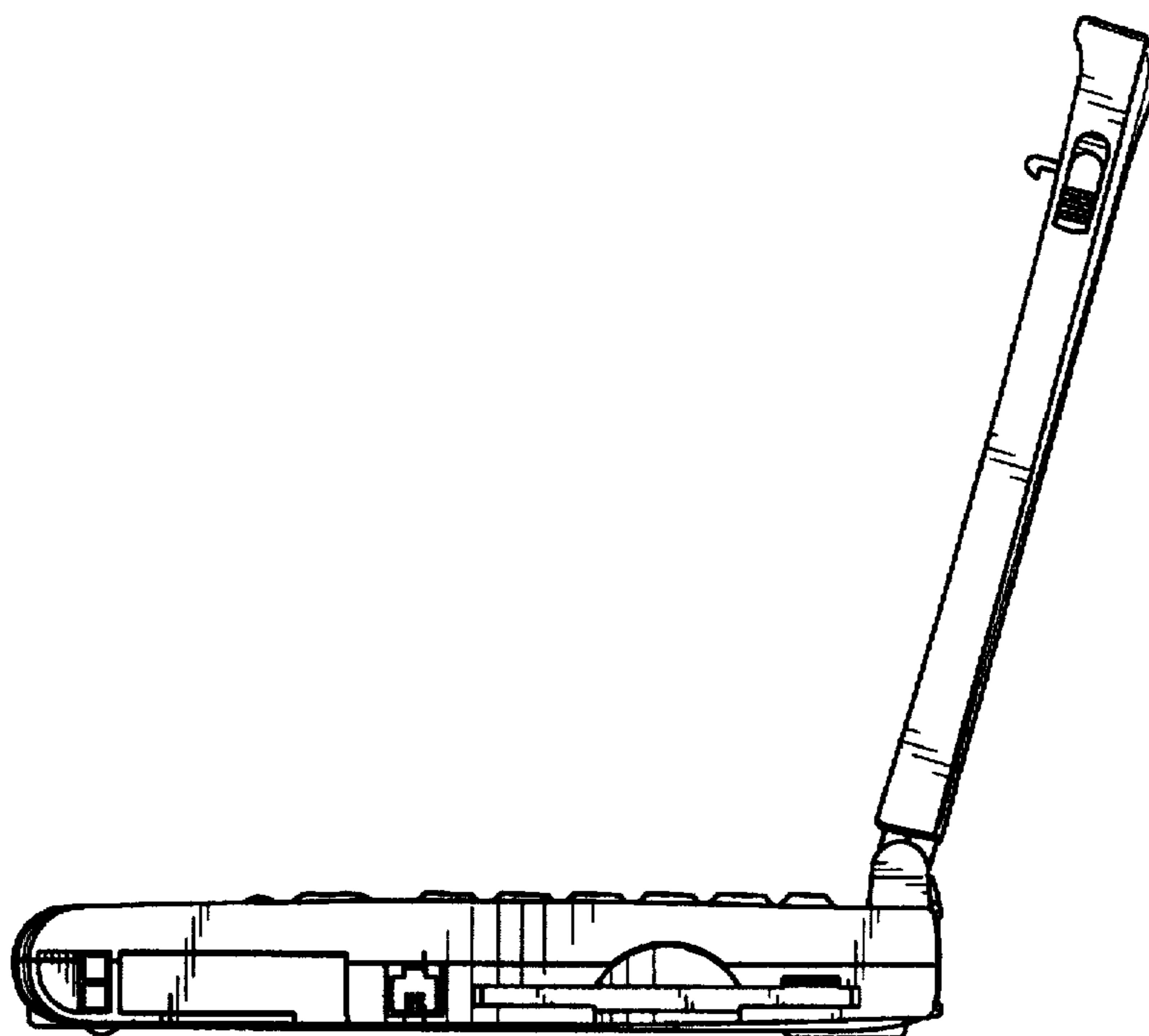

Fig. 5

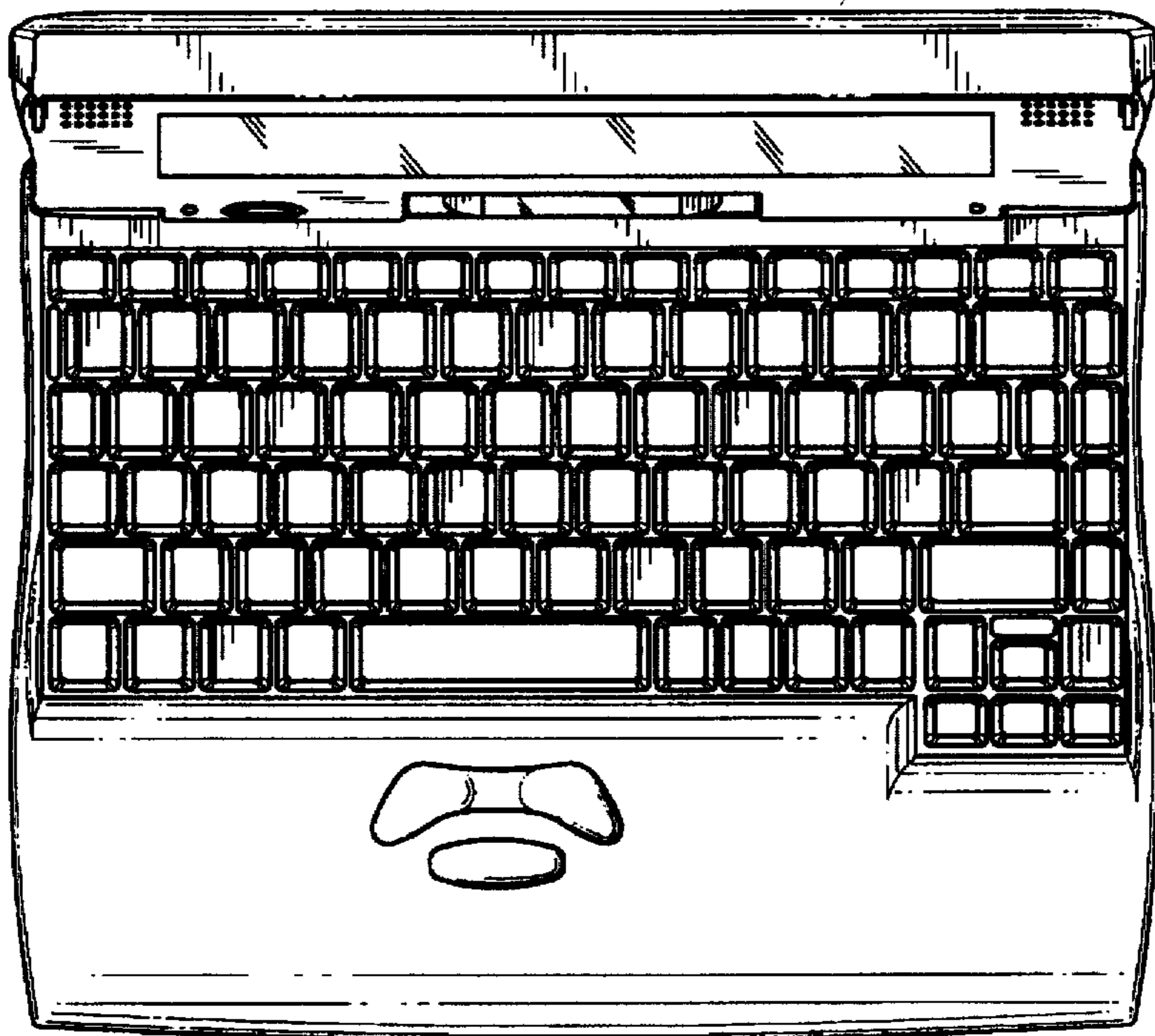

Fig. 6

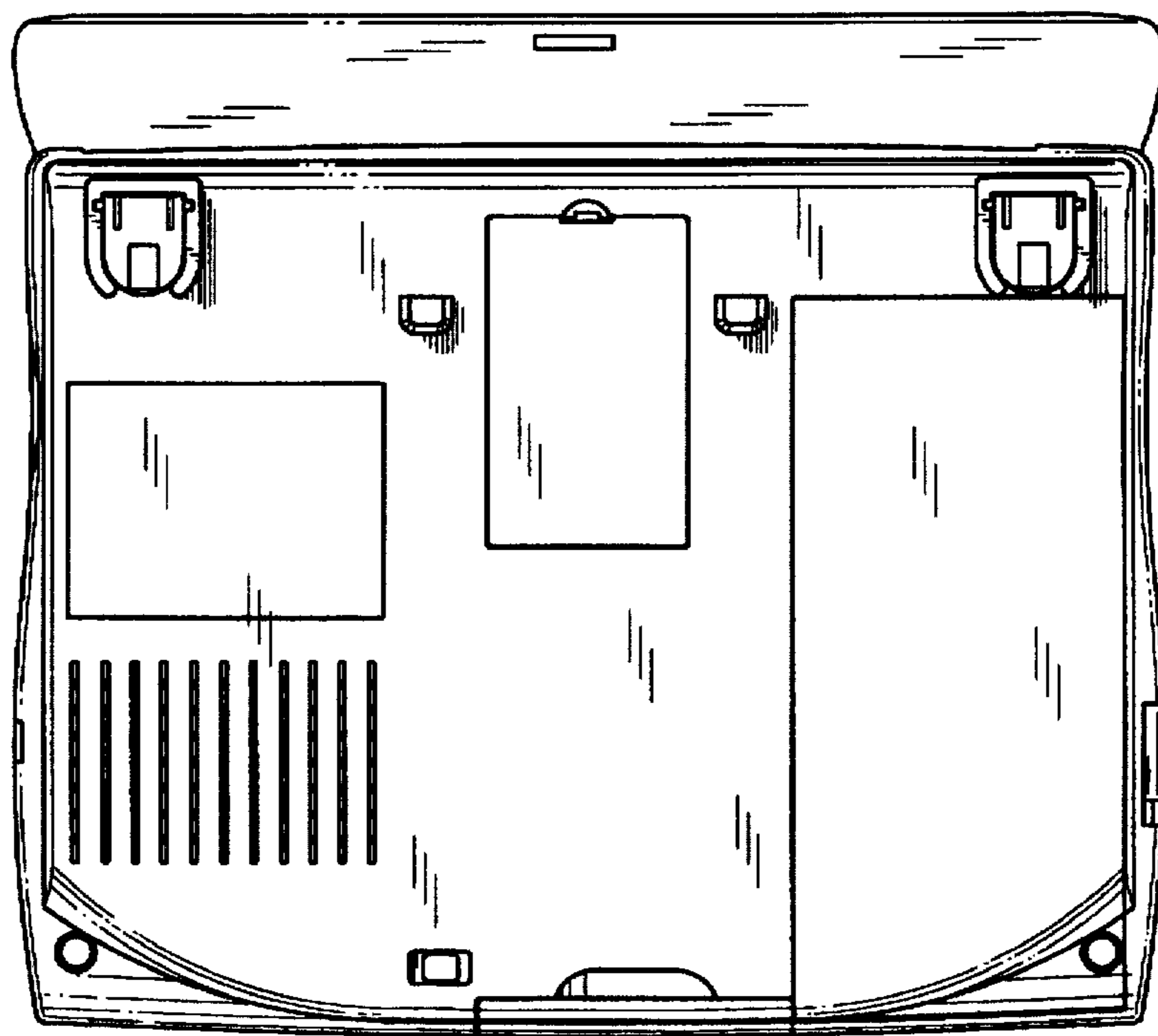

Fig. 7

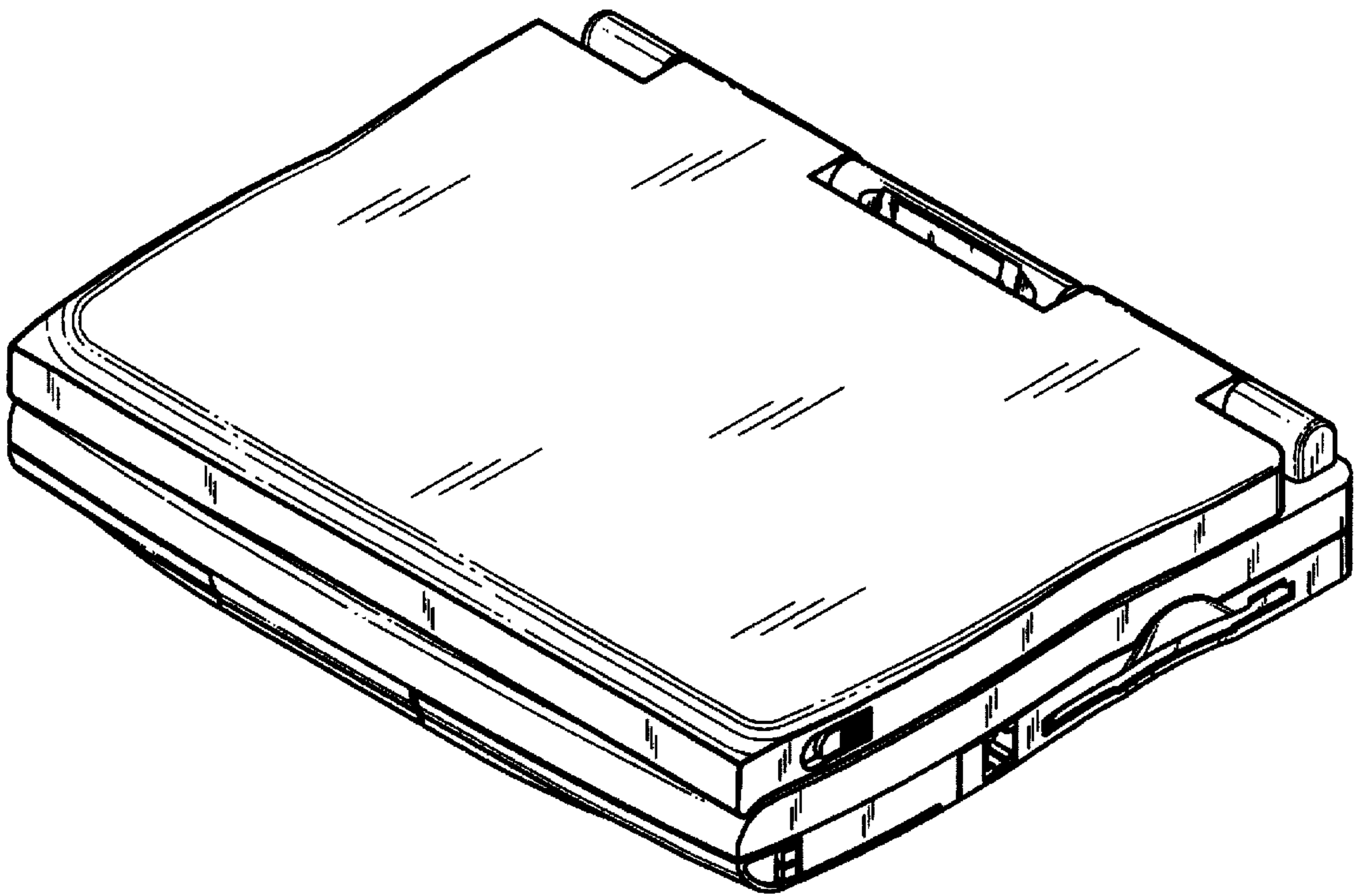

Fig. 8

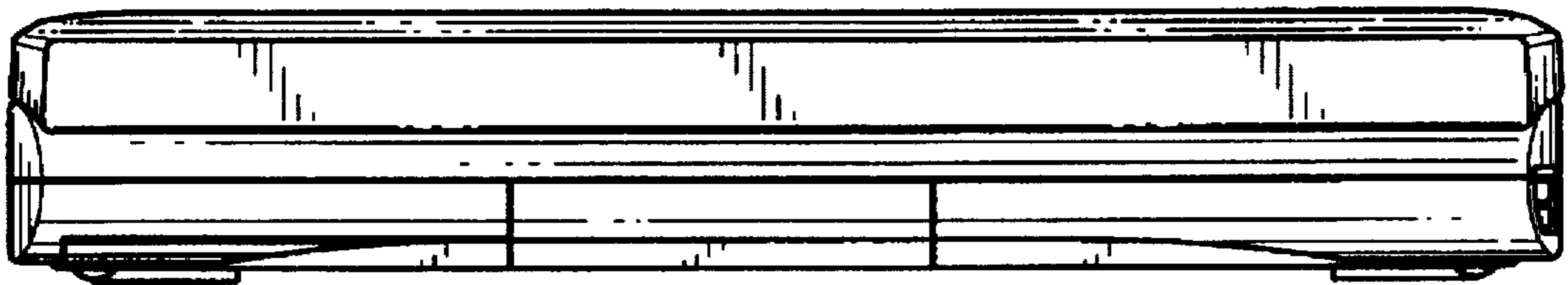

Fig. 9

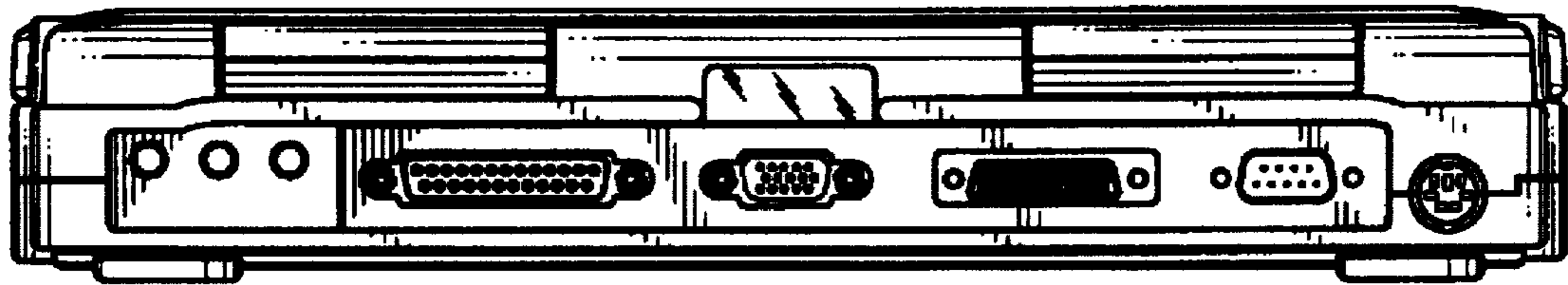

Fig. 10

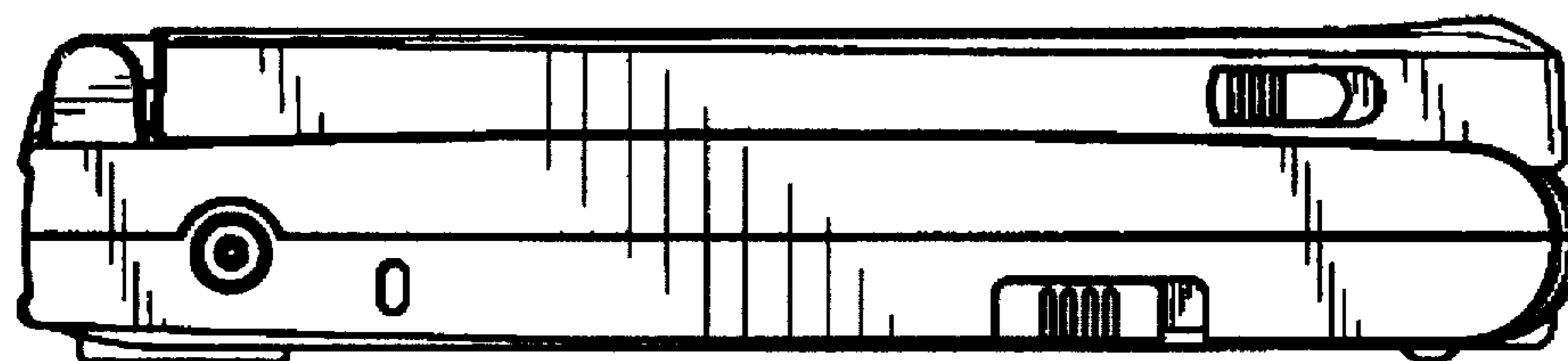

Fig. 11

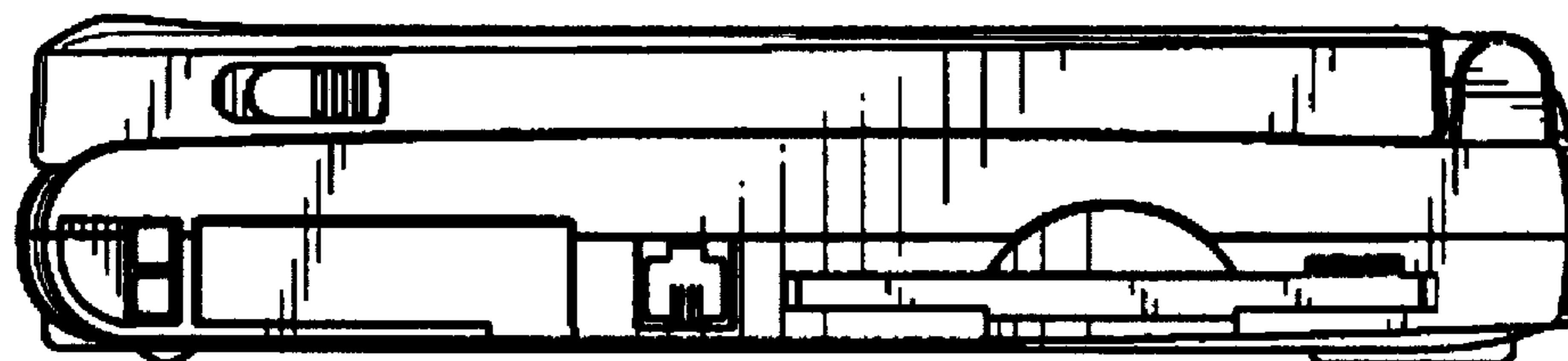

Fig. 12

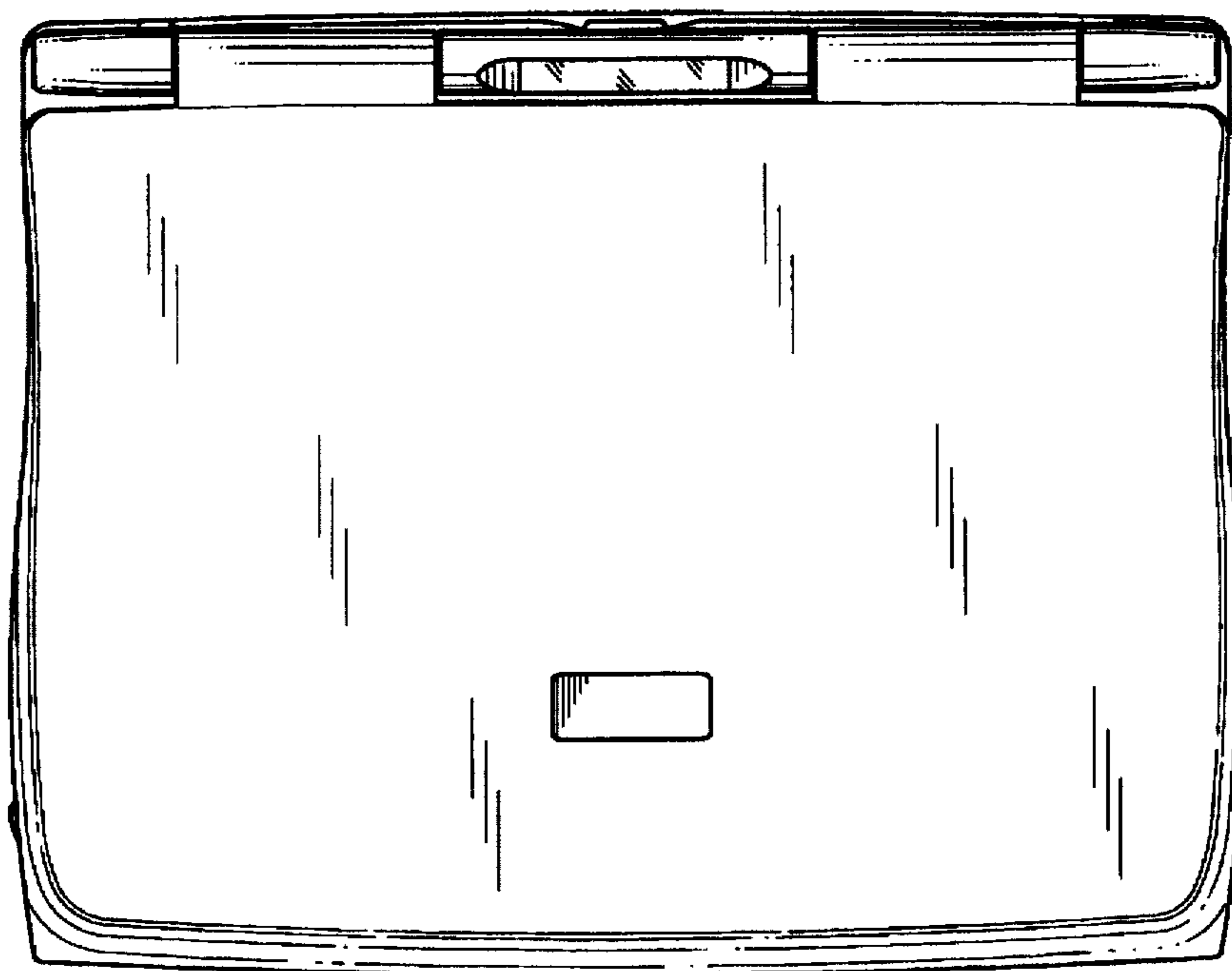

Fig. 13

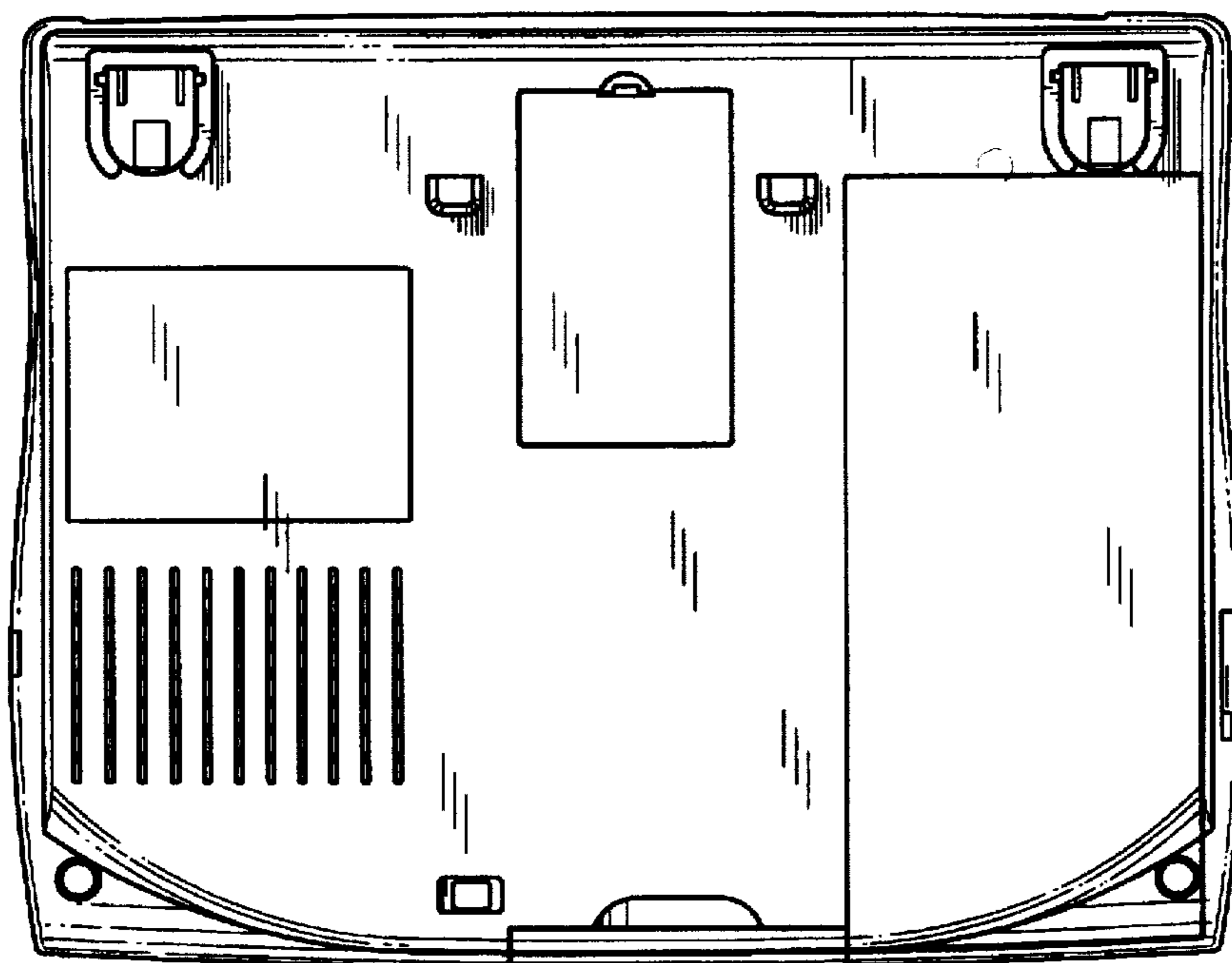

Fig. 14