



US00D386468S

United States Patent [19]

Gogan et al.

[11] Patent Number: Des. 386,468

[45] Date of Patent: **Nov. 18, 1997

[54] MOTORCYCLE LUGGAGE CARRIER

[75] Inventors: Donald M. Gogan, Brookfield;
Geoffrey T. Williams, Mequon, both of Wis.

[73] Assignee: Harley-Davidson Motor Company,
Milwaukee, Wis.

[**] Term: 14 Years

[21] Appl. No.: 53,917

[22] Filed: May 1, 1996

[51] LOC (6) Cl. 12-16

[52] U.S. Cl. D12/407

[58] Field of Search D12/407; 224/32 A,
224/32 R, 30 A, 30 R, 39

V-Twin 1993 Catalog, p. 511.

Custom Chrome 1994 Catalog, pp. 623-624.

Harley-Davidson 1995 Parts and Accessories Catalog, pp. 41, 63, 73 and 82.

"Sissy Bars, Racks & Bags," from *Hot Road Bikes*, pp. 67-68, Jan., 1996.

Drag Specialties Catalog, 1995, p. 6, the Fender Luggage Racks.

Primary Examiner—Melody N. Brown

Attorney, Agent, or Firm—Michael, Best & Friedrich

[57] CLAIM

The ornamental design for a motorcycle luggage carrier, as shown and described.

DESCRIPTION

FIG. 1 is a perspective view of an ornamental design of a motorcycle luggage carrier according to our invention;

FIG. 2 is a right side view thereof, the left side view being a mirror image of the right side view;

FIG. 3 is a top side view thereof;

FIG. 4 is a bottom view thereof;

FIG. 5 is a front view thereof; and,

FIG. 6 is a rear view thereof.

[56] References Cited

U.S. PATENT DOCUMENTS

D. 230,018	1/1974	Abrams	D12/407
D. 230,965	3/1974	Heltzen	D12/407
D. 255,561	6/1980	Pold et al.	D12/407
D. 271,389	11/1983	Turkington et al.	D12/407
D. 276,331	11/1984	Heiman et al.	D12/407
4,032,189	6/1977	Benavente et al.	297/352
4,993,731	2/1991	Fuller	280/202

OTHER PUBLICATIONS

Harley-Davidson 1992 Accessories Catalog, pp. 10, 13, 18-19, 24-25, 30, 37, 40, 47 and 63.

Harley-Davidson 1993 Accessories Catalog, p. 20.

1 Claim, 3 Drawing Sheets

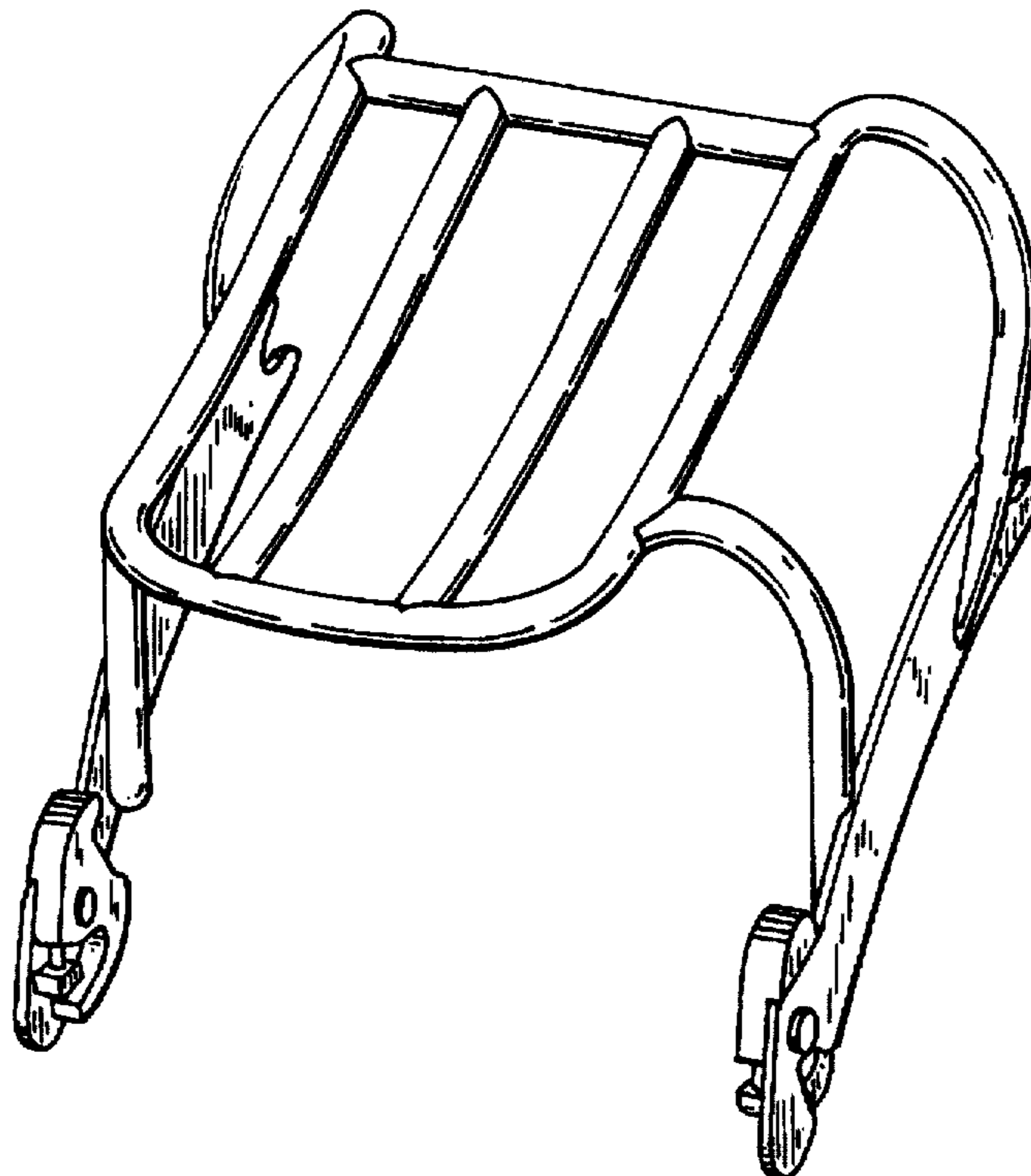

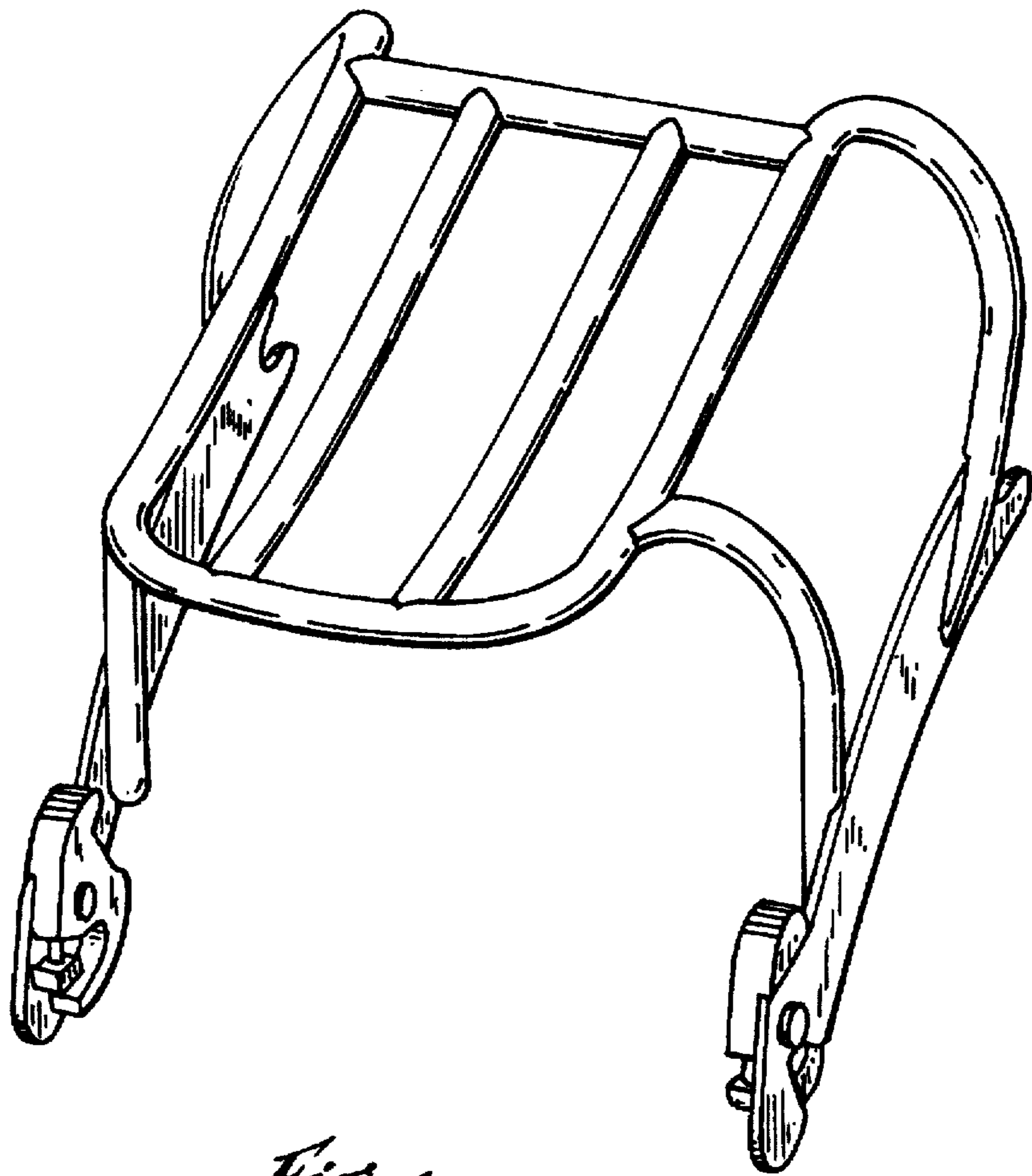

Fig. 1

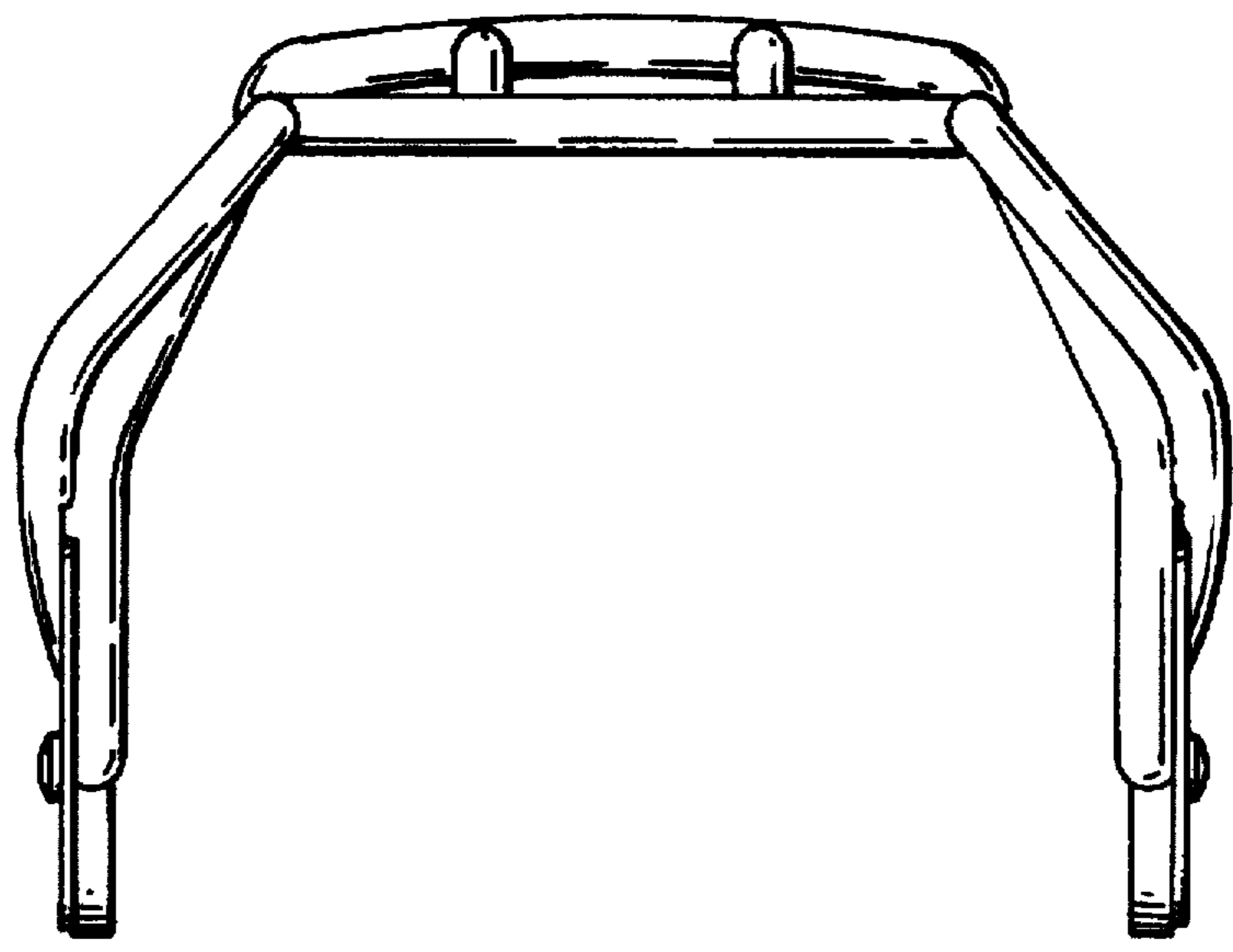

Fig. 5

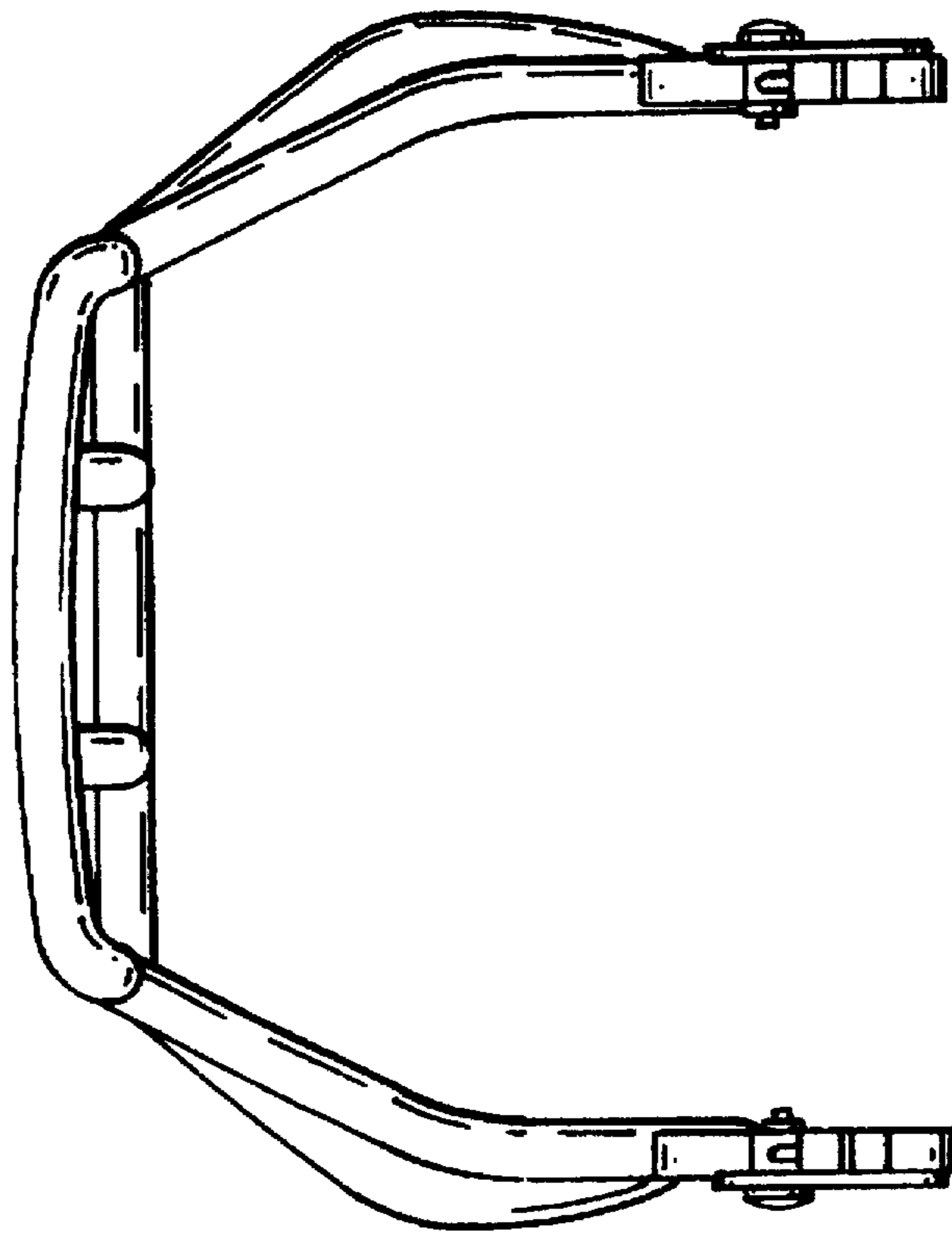

Fig. 6

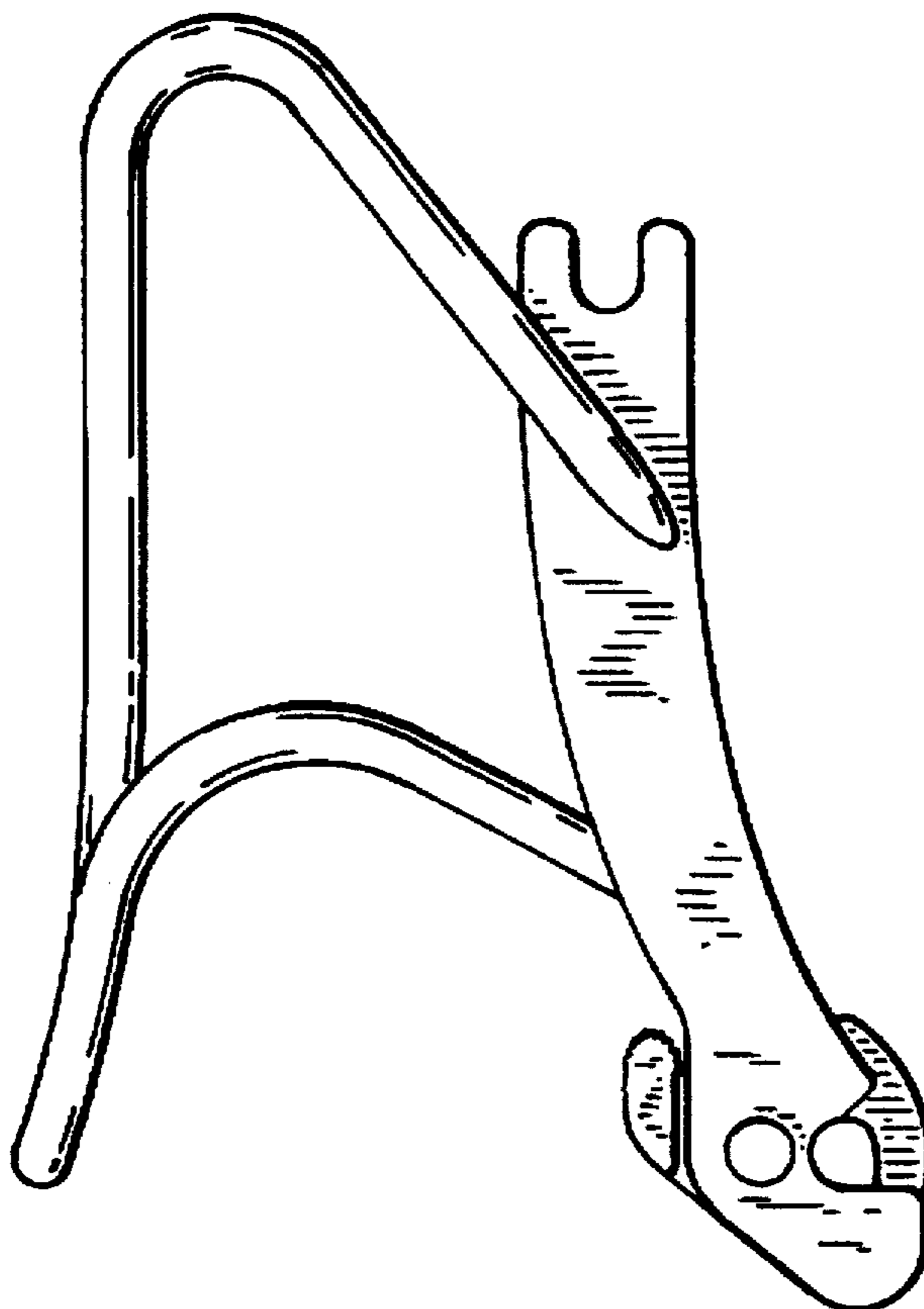

Fig. 7

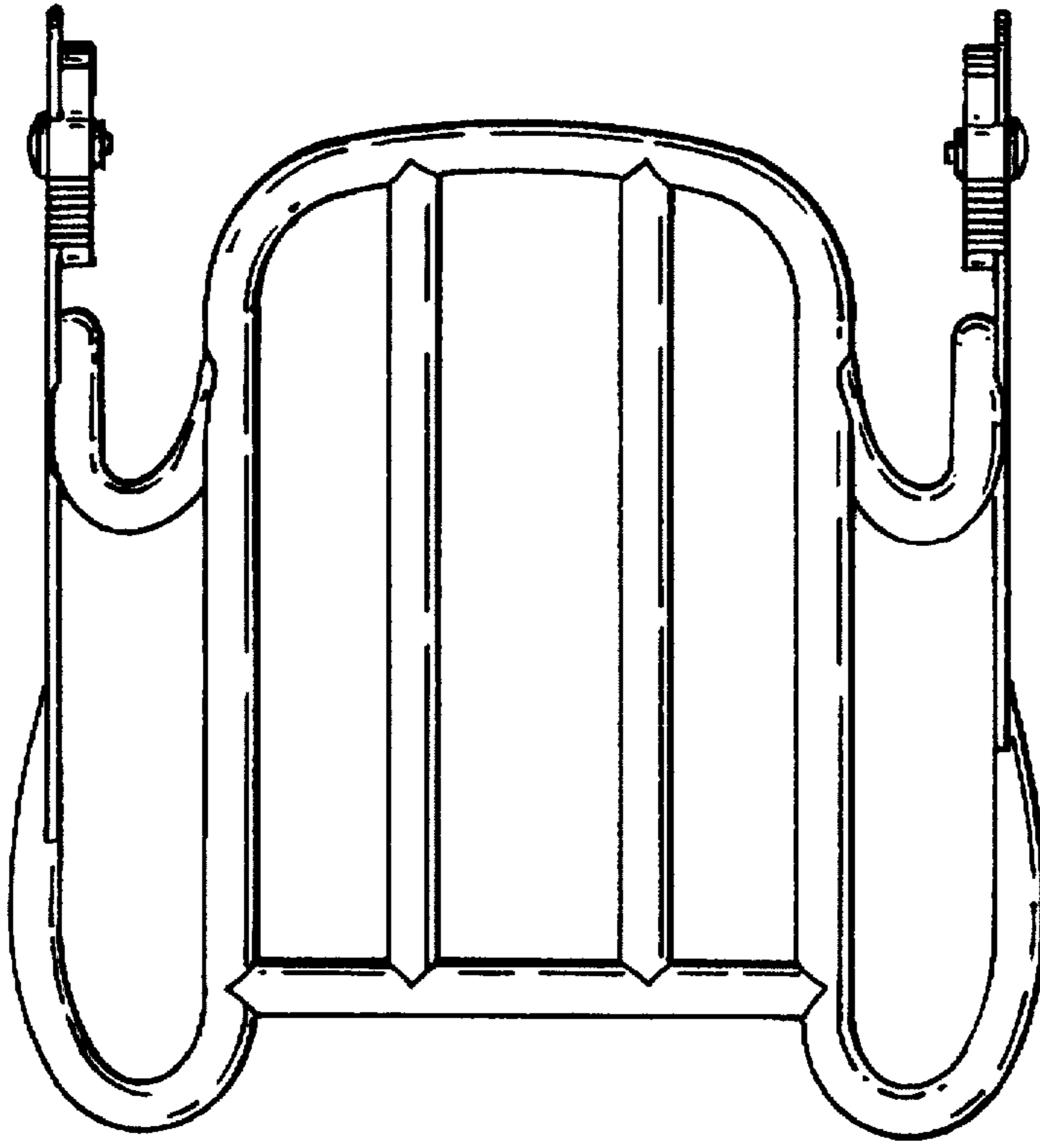

Fig. 3

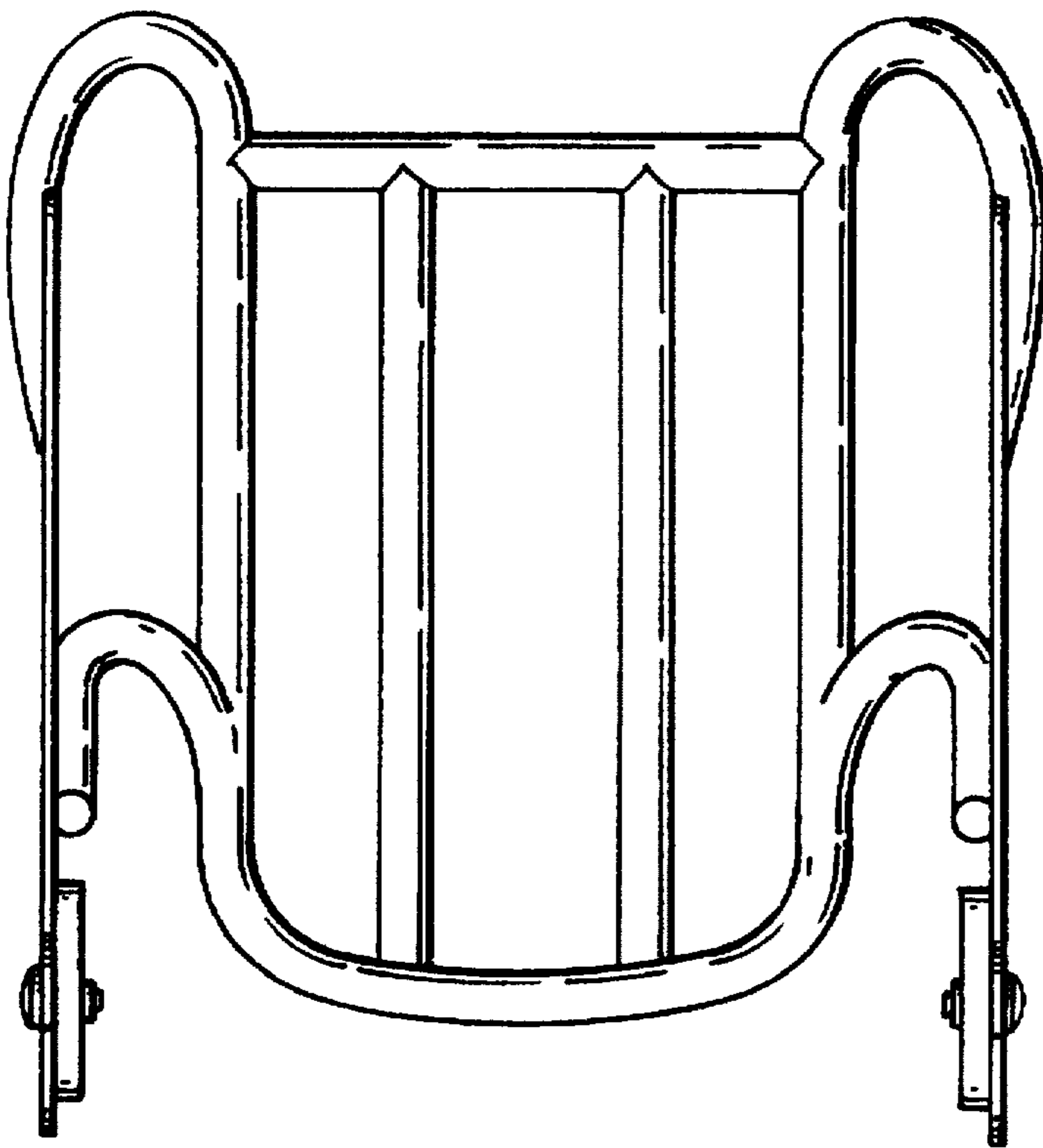

Fig. 4