



US00D386388S

United States Patent [19]
Antonucci

[11] **Patent Number: Des. 386,388**
[45] **Date of Patent: **Nov. 18, 1997**

[54] **FOLDABLE SPACER**

[76] **Inventor: Mark Antonucci, 2520-A Fifth St.,
Santa Monica, Calif. 90405**

[**] **Term: 14 Years**

[21] **Appl. No.: 36,389**

[22] **Filed: Mar. 20, 1995**

[51] **LOC (6) Cl. 08-05**

[52] **U.S. Cl. D8/354**

[58] **Field of Search D8/354; 411/547,
411/544**

[56] **References Cited**

U.S. PATENT DOCUMENTS

4,909,692 3/1990 Hendren 411/544
5,108,243 4/1992 Antonucci 411/547

Primary Examiner—Holly Baynham
Attorney, Agent, or Firm—Thomas I. Rozsa; Tony D. Chen

[57] **CLAIM**

The ornamental design for a foldable spacer, as shown and described.

DESCRIPTION

FIG. 1 is a perspective view of the foldable spacer, showing my new design in its unfolded condition;
FIG. 2 is a front elevational view thereof;
FIG. 3 is a rear elevational view thereof;
FIG. 4 is a left side elevational view thereof;
FIG. 5 is a right side elevational view thereof;
FIG. 6 is an end elevational view, the other end being identical;
FIG. 7 is an enlarged perspective view of the foldable spacer, showing my new design in its folded condition;
FIG. 8 is a top plan view thereof;
FIG. 9 is a bottom plan view thereof;
FIG. 10 is a front elevational view thereof;
FIG. 11 is a rear elevational view thereof;
FIG. 12 is a left side elevational view thereof; and,
FIG. 13 is a right side elevational view thereof.

1 Claim, 2 Drawing Sheets

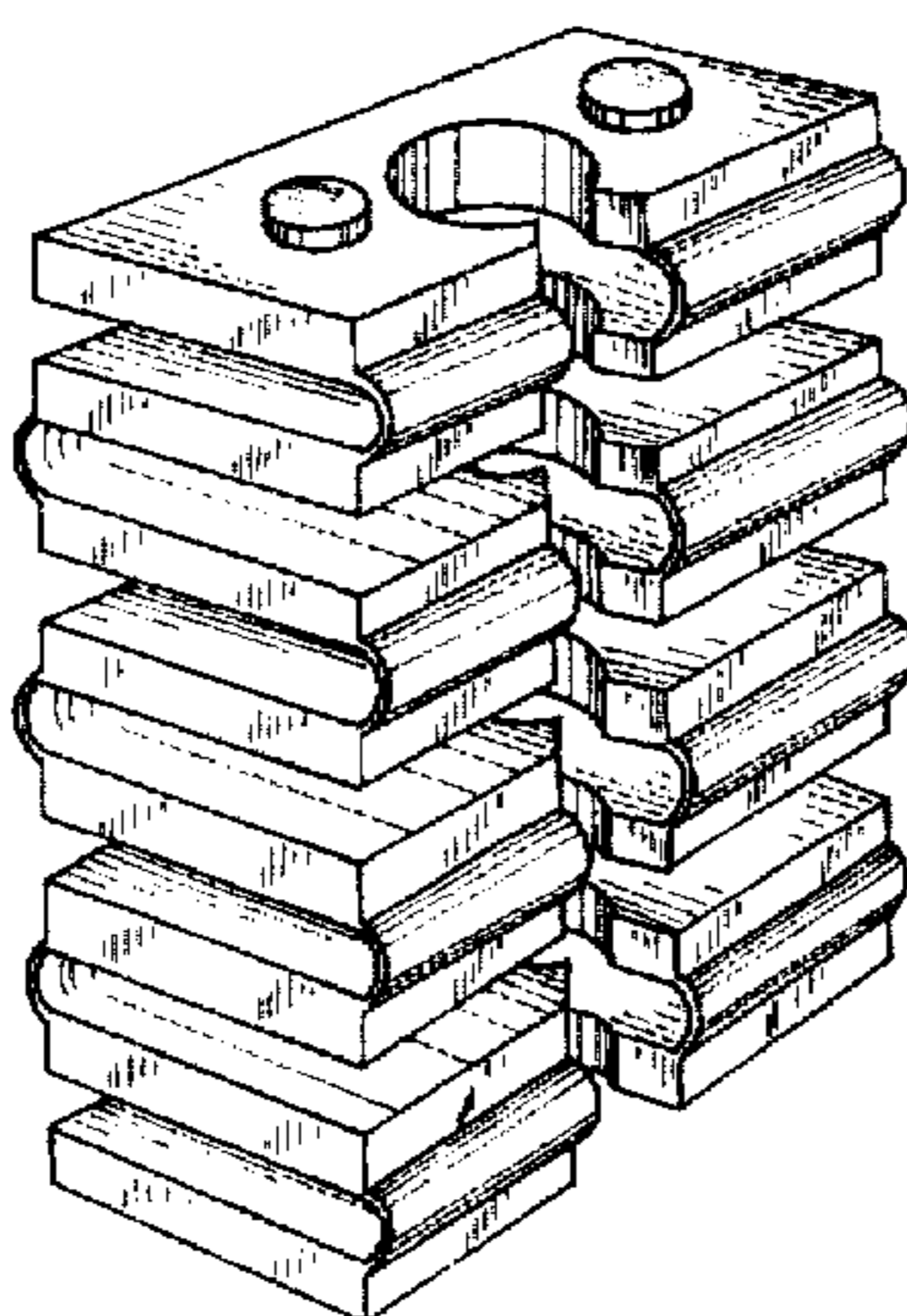
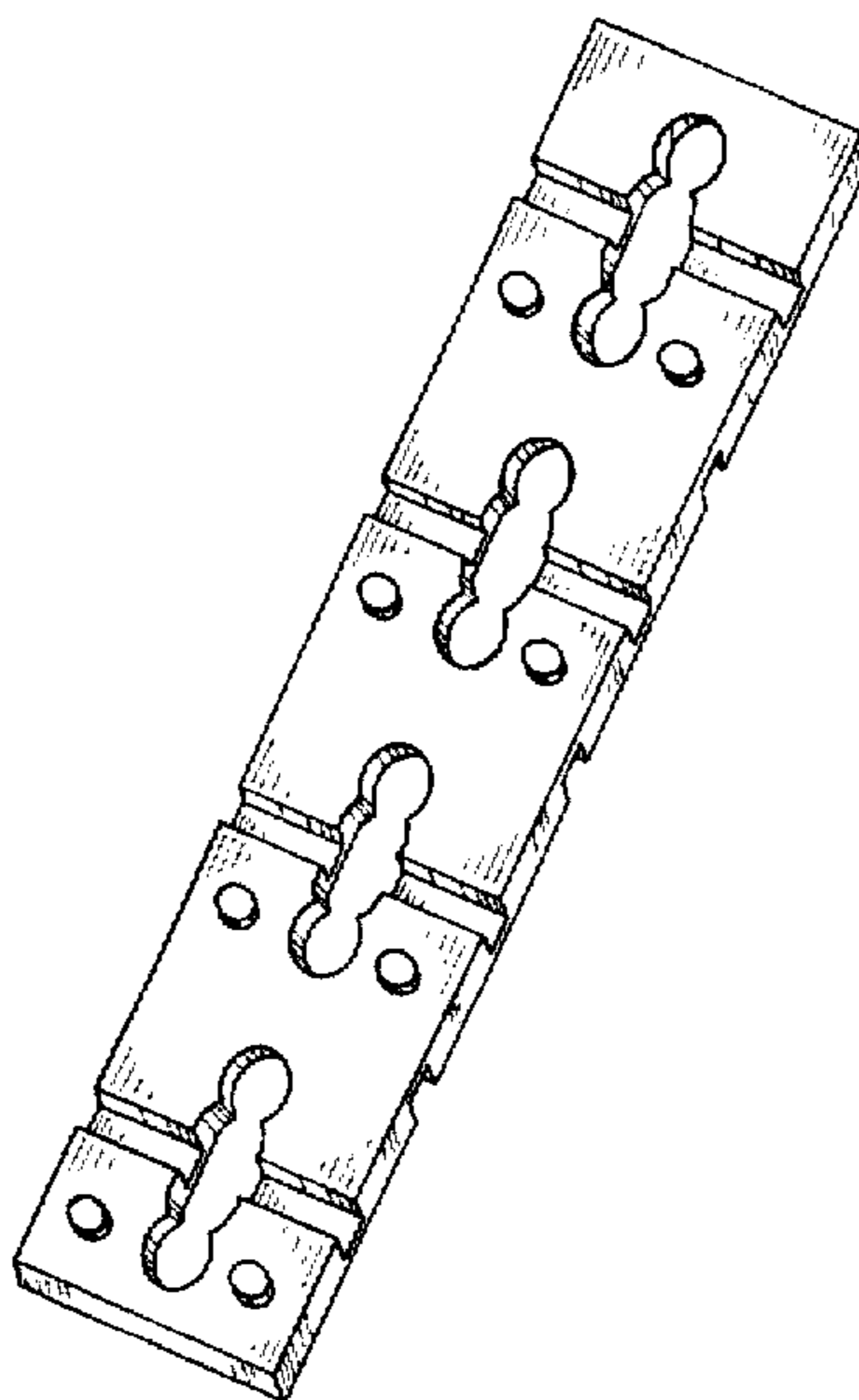

FIG.1

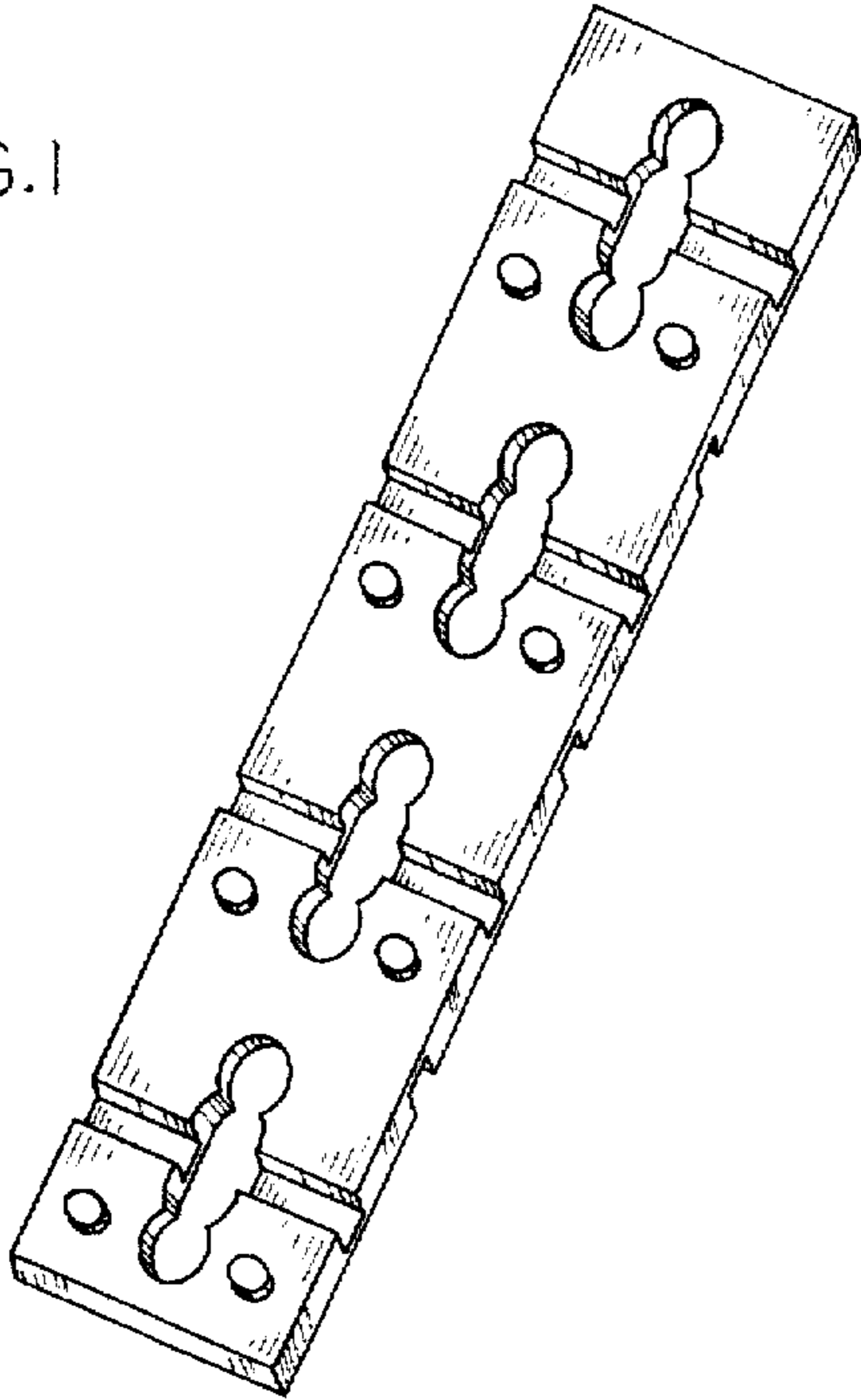

FIG.2

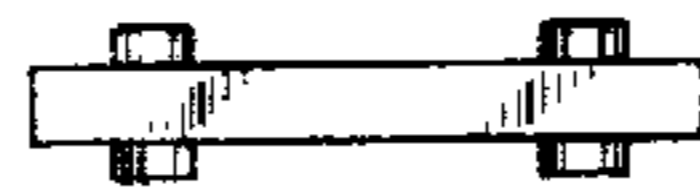
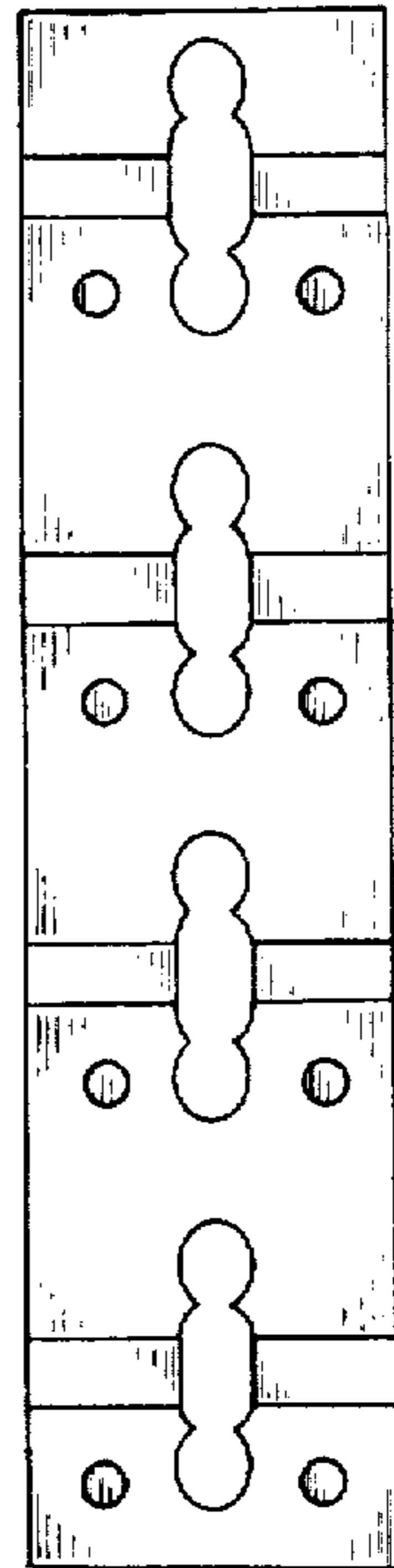

FIG.6

FIG.4

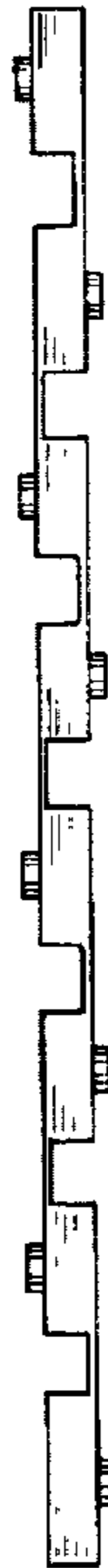
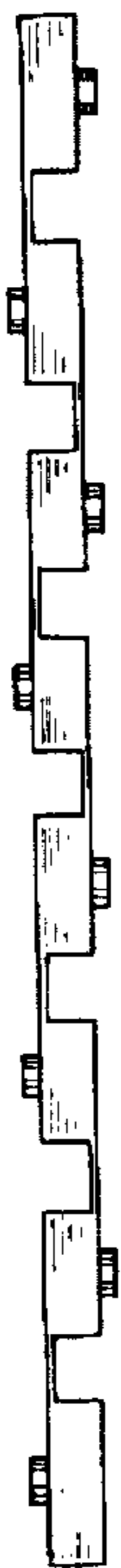
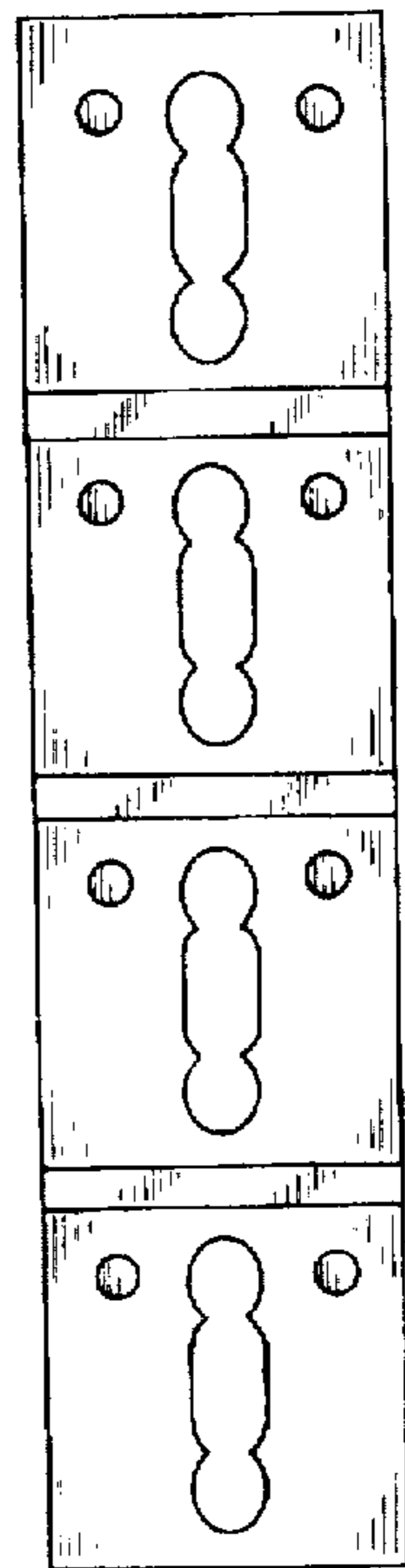

FIG.5

FIG.3



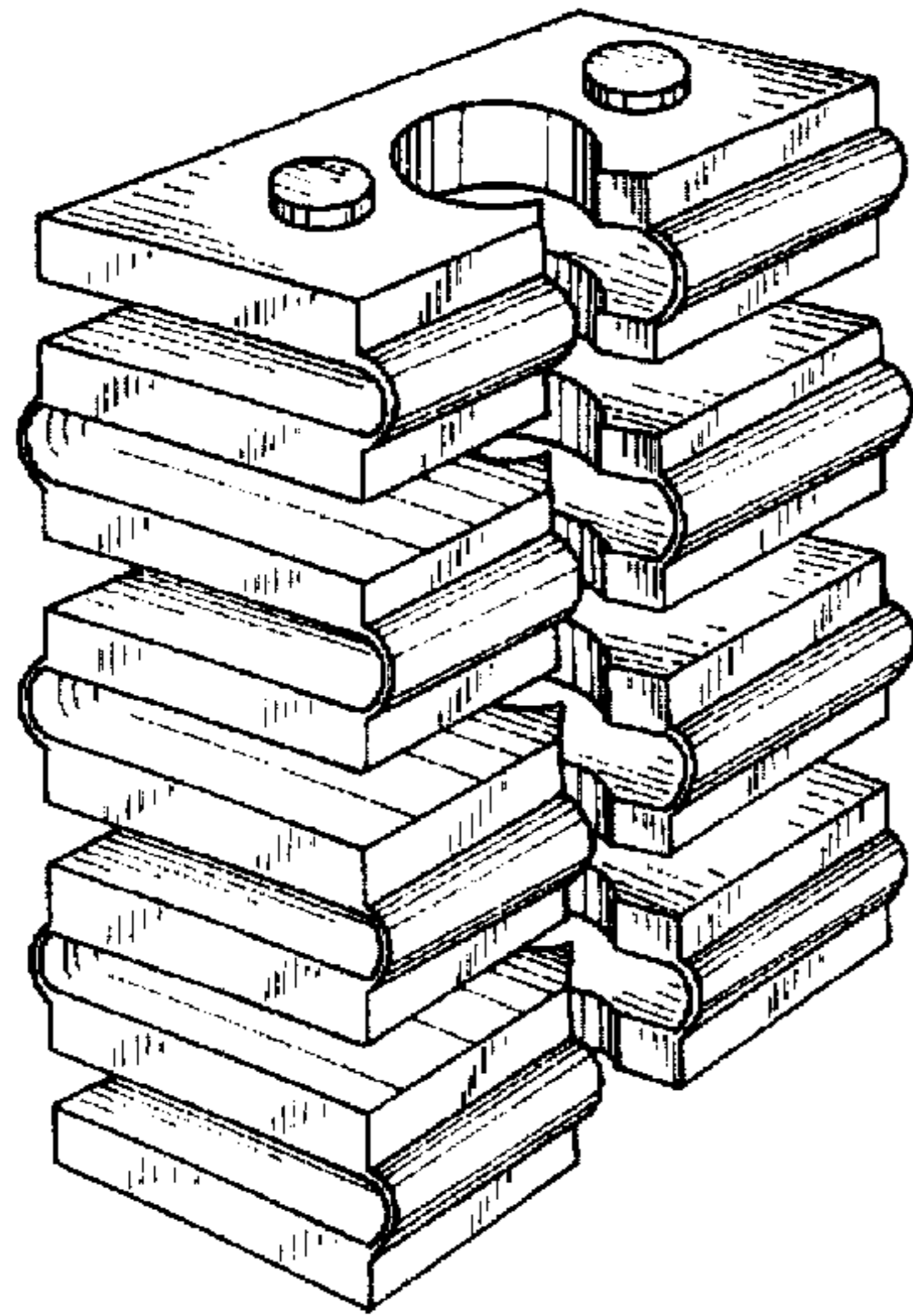

FIG. 7

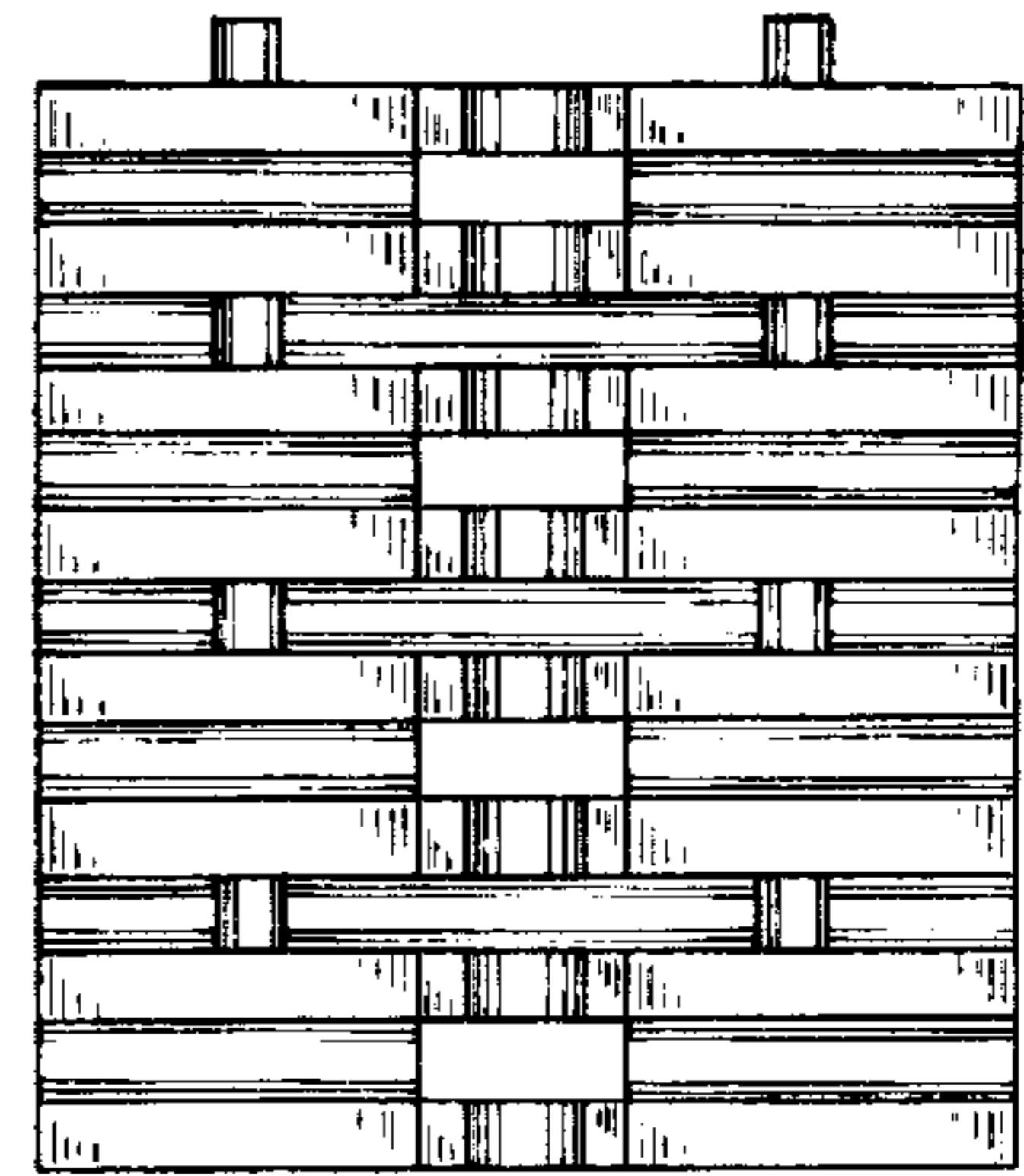

FIG. 10

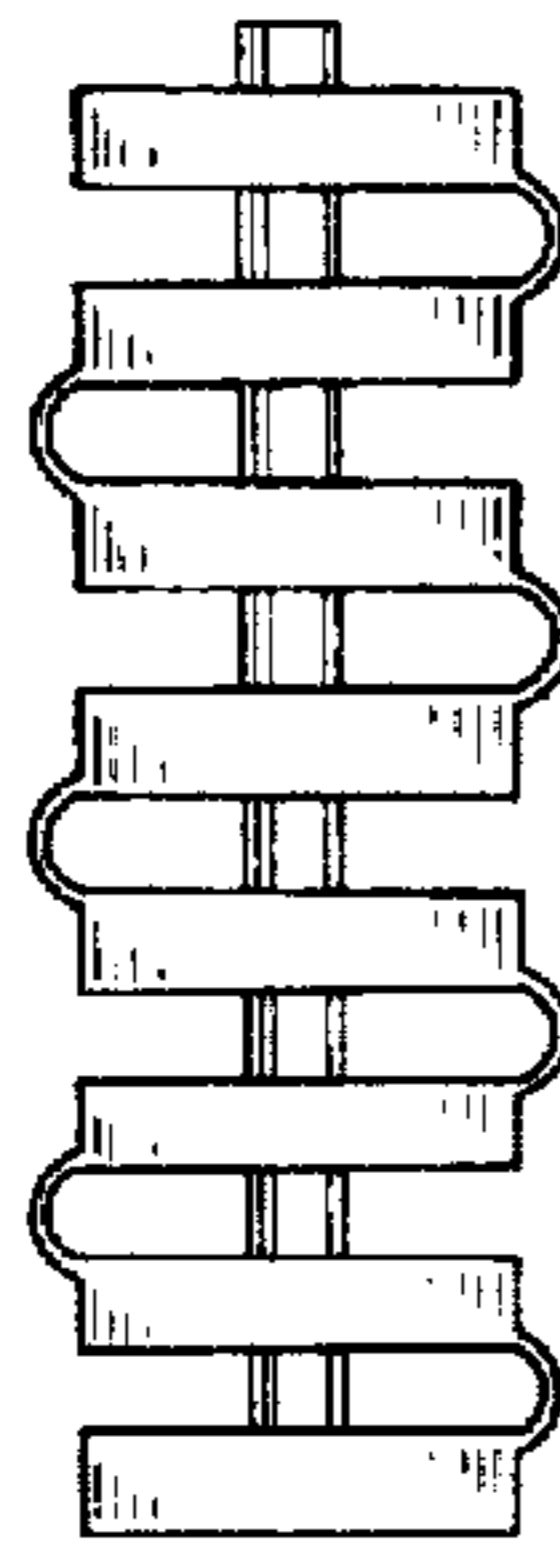

FIG. 12

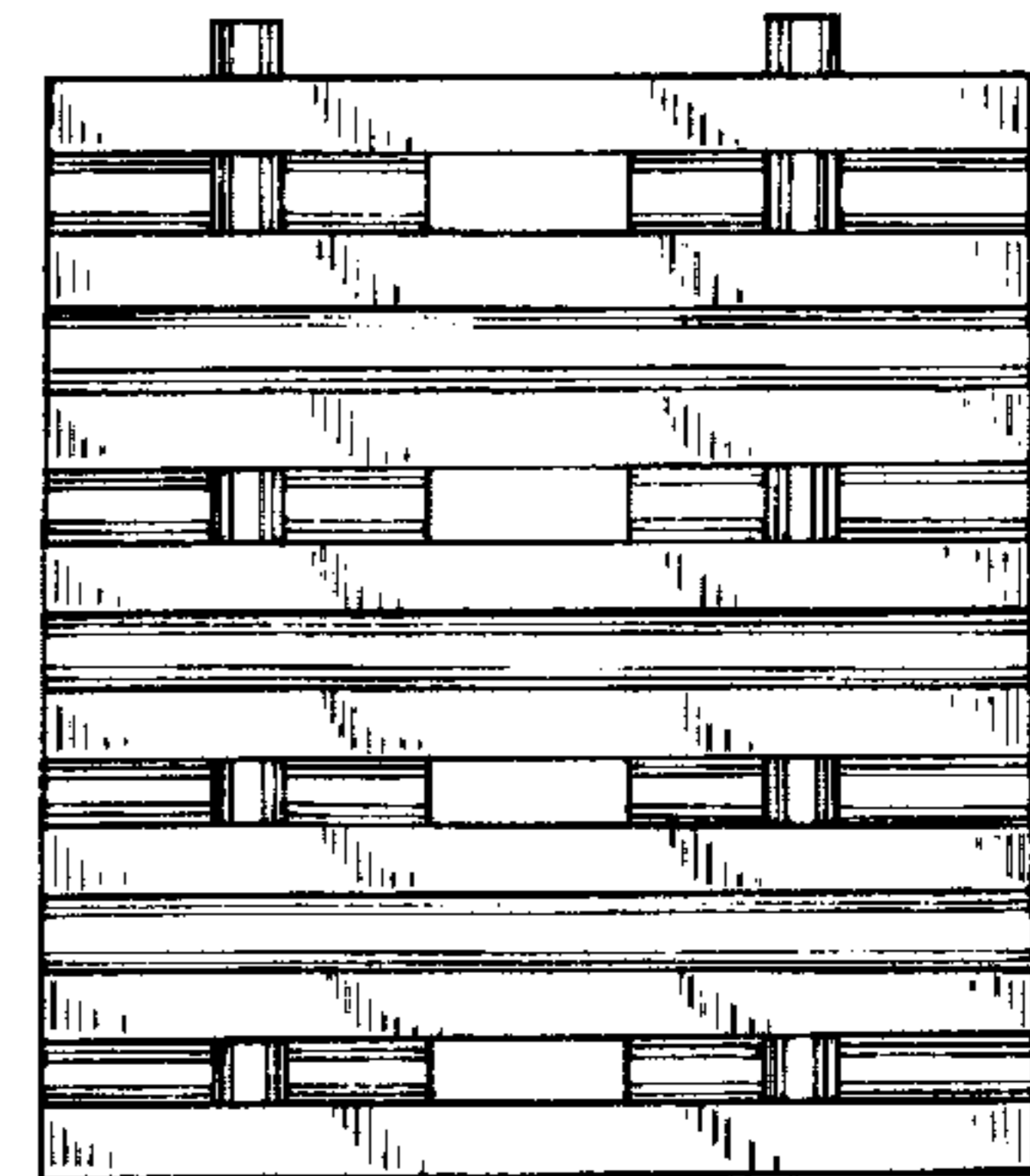

FIG. 11

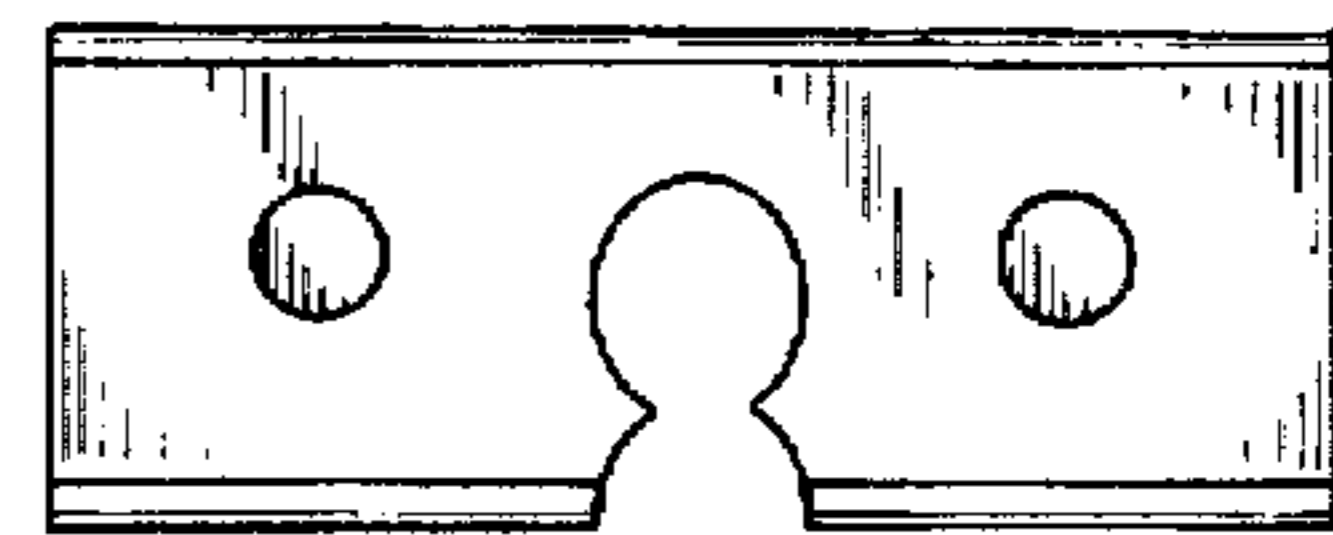

FIG. 8

FIG. 13

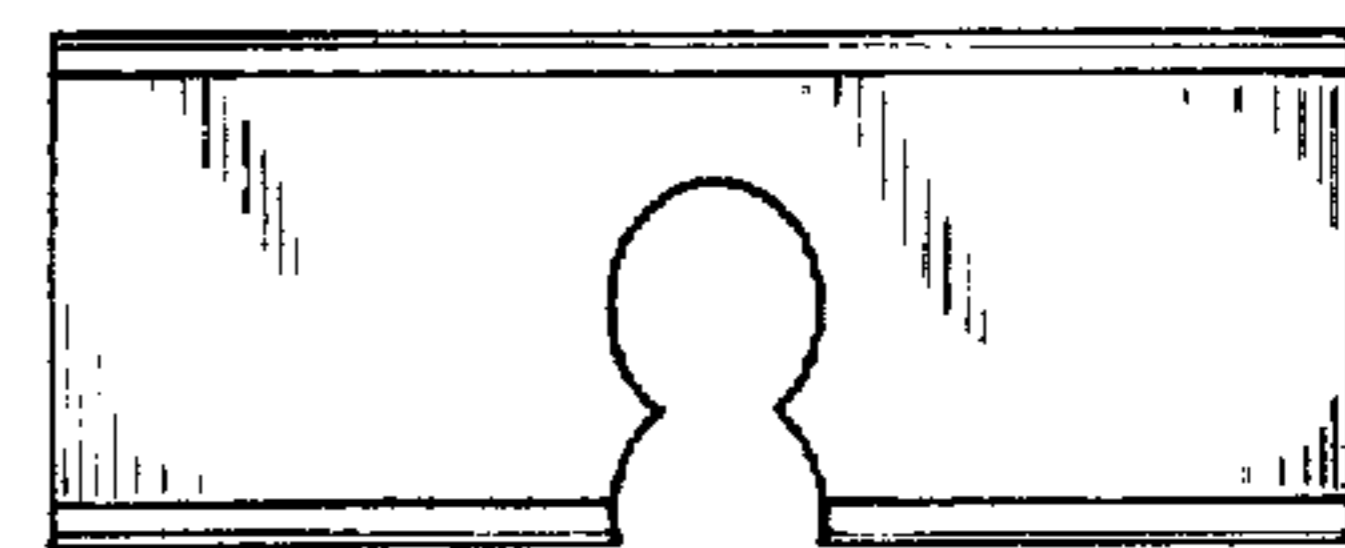
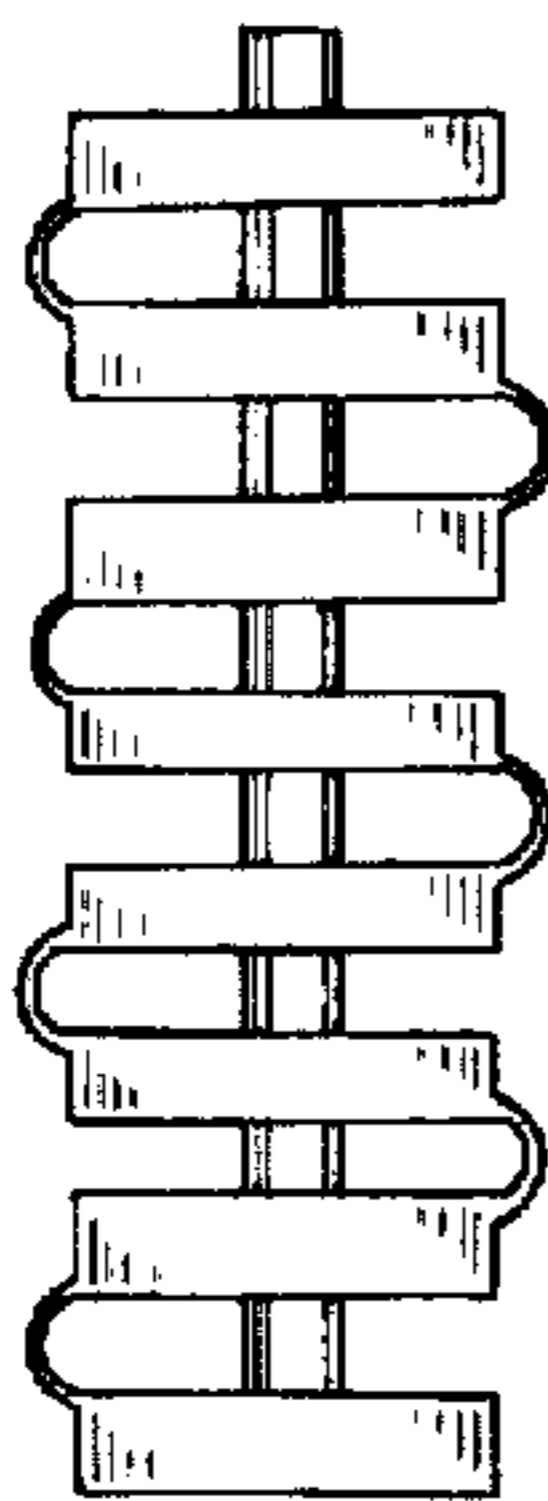

FIG. 9