



US00D386353S

# United States Patent [19]

Fujimoto et al.

[11] Patent Number: Des. 386,353

[45] Date of Patent: \*\*Nov. 18, 1997

- [54] MICROWAVE OVEN
- [75] Inventors: **Munenori Fujimoto; Akio Mikami,**  
both of Nara, Japan
- [73] Assignee: **Matsushita Electric Industrial Co.,**  
**Ltd.,** Osaka, Japan
- [\*\*] Term: **14 Years**
- [21] Appl. No.: **59,224**
- [22] Filed: **Sep. 5, 1996**
- [51] LOC (6) Cl. .... **07-02**
- [52] U.S. Cl. .... **D7/351**
- [58] Field of Search ..... D7/348-351; 126/275 R,  
126/275 E, 19 M, 214; 219/10.55 R, 10.55 A,  
10.55 B, 10.55 C

- D. 313,919 1/1991 Naito et al. .... D7/351
- D. 329,569 9/1992 Ichihara et al. .
- D. 330,144 10/1992 Takebata et al. .... D7/351

### FOREIGN PATENT DOCUMENTS

- 657199 6/1987 Japan .
- 754019 2/1989 Japan .

*Primary Examiner*—Ruth McInroy  
*Attorney, Agent, or Firm*—Sughrue, Mion, Zinn, Macpeak  
 and Seas

### [57] CLAIM

The ornamental design for a microwave oven, as shown and described.

### DESCRIPTION

FIG. 1 is a perspective view of the top, front and right side of a microwave oven showing our new design;  
 FIG. 2 is a front elevational view thereof;  
 FIG. 3 is a top plan view thereof;  
 FIG. 4 is a right side elevational view thereof, the left side elevational view being a mirror image thereof;  
 FIG. 5 is a rear elevational view thereof;  
 FIG. 6 is a bottom plan view thereof; and,  
 FIG. 7 is a perspective view thereof, with the control panel door in an open position.

1 Claim, 4 Drawing Sheets

### [56] References Cited

#### U.S. PATENT DOCUMENTS

- D. 248,008 5/1978 Wojtowica et al. .... D7/351
- D. 249,449 9/1978 Pink et al. .... D7/351
- D. 275,545 9/1984 Kenichi et al. .... D7/351
- D. 275,642 9/1984 Kenichi et al. .... D7/351
- D. 275,724 10/1984 Kenichi et al. .... D7/351
- D. 304,281 10/1989 Naito et al. .... D7/351
- D. 310,150 8/1990 Ichihara et al. .... D7/351

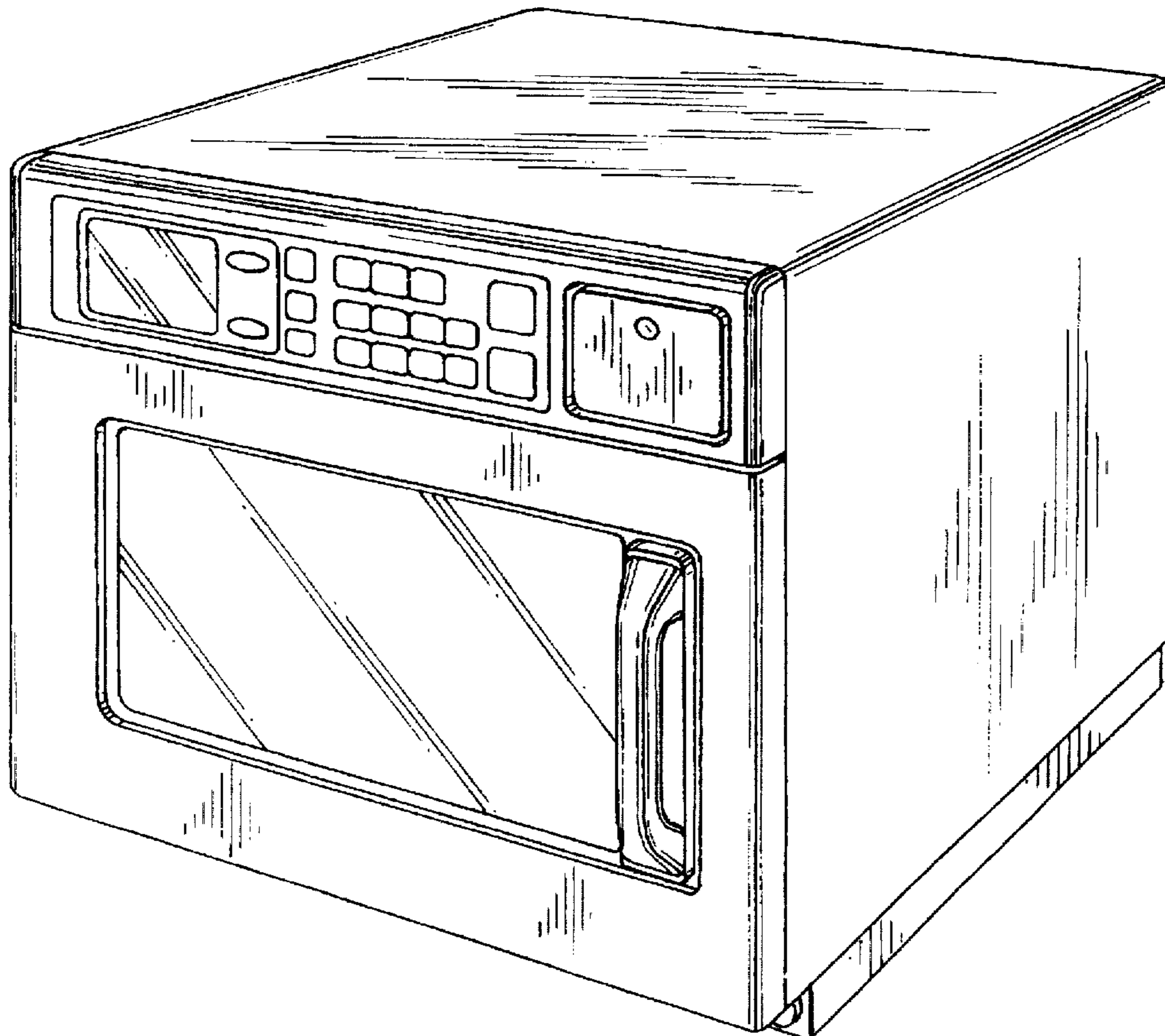

FIG. 1

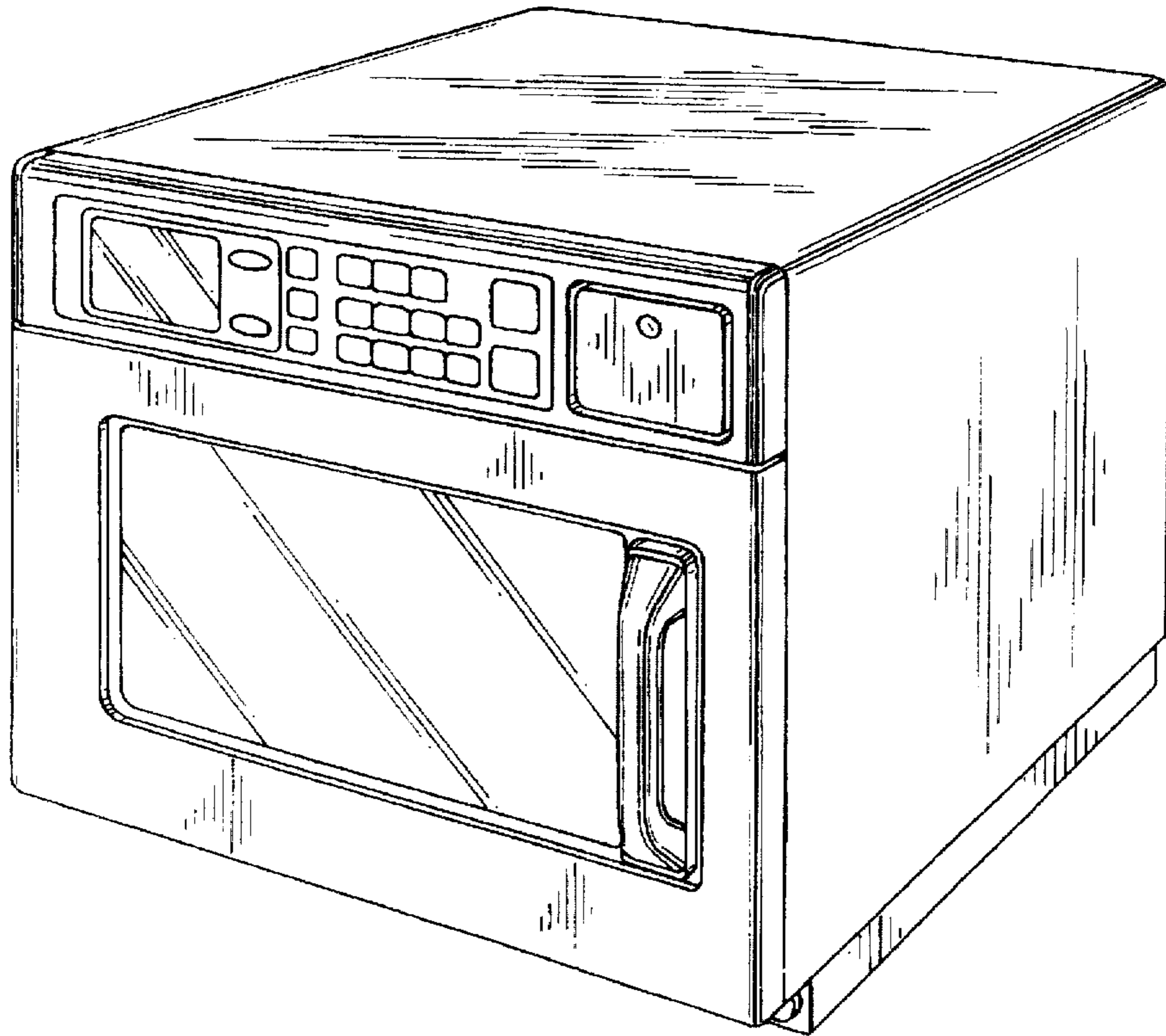

FIG. 2

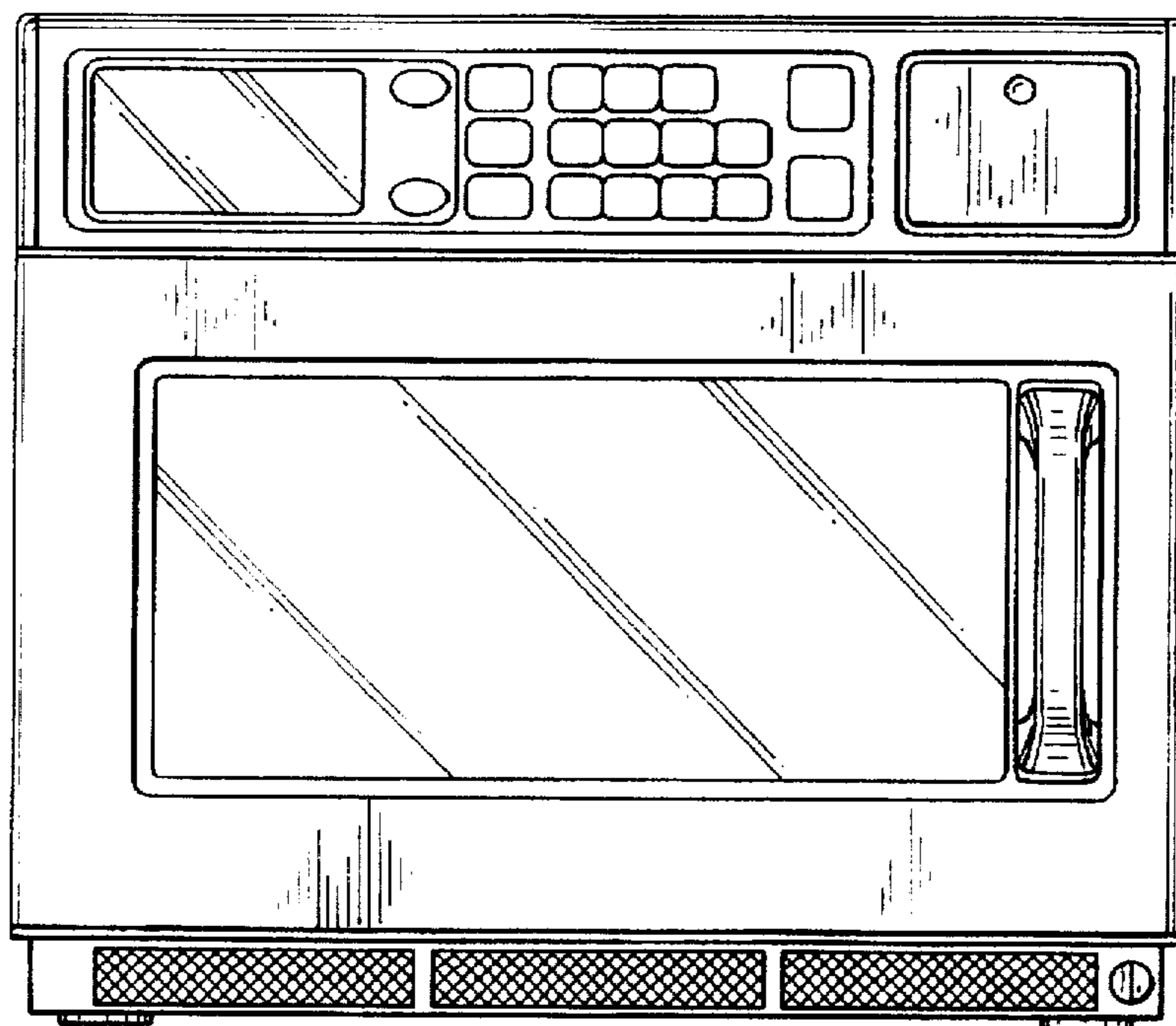

FIG. 3

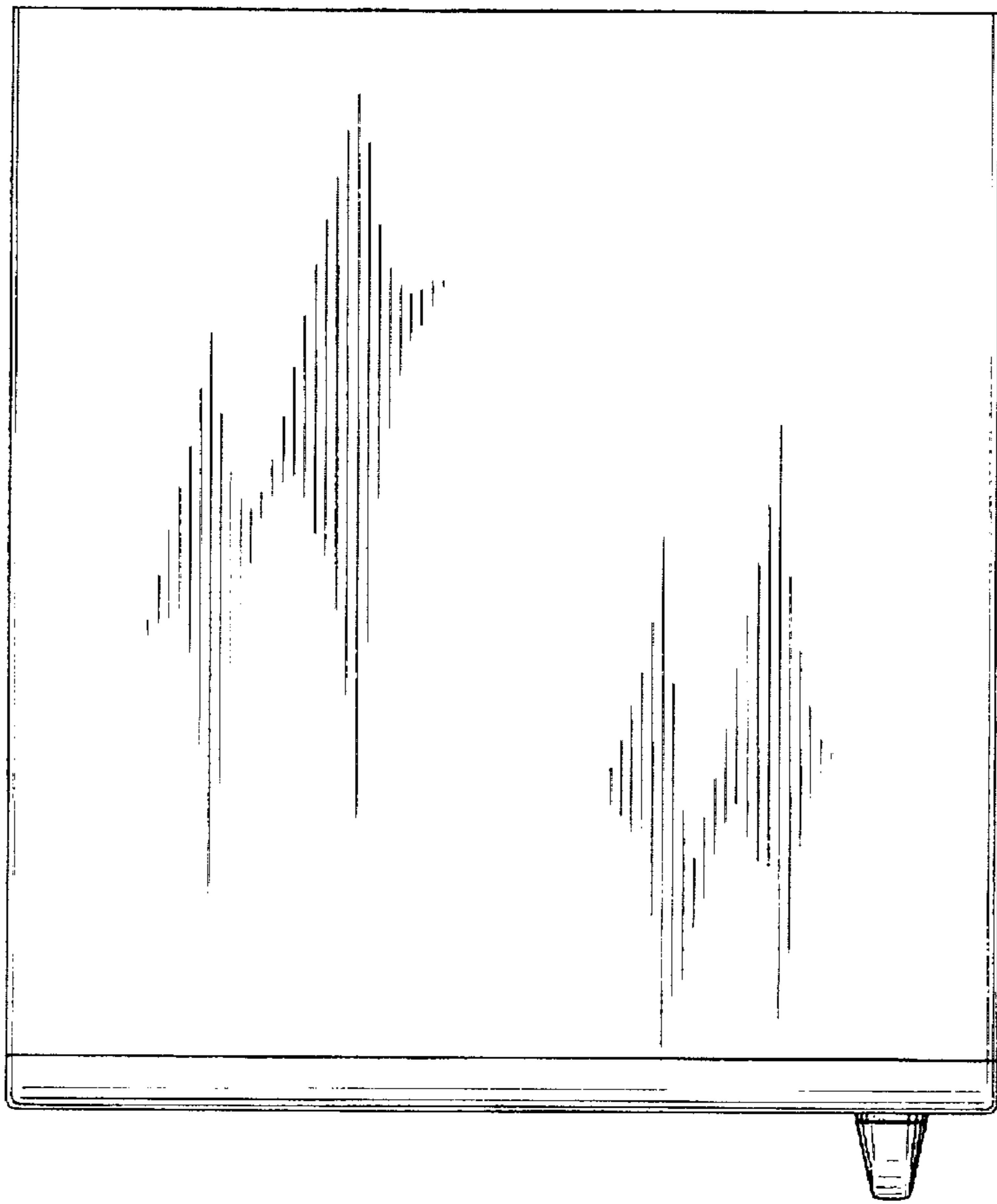

FIG. 4

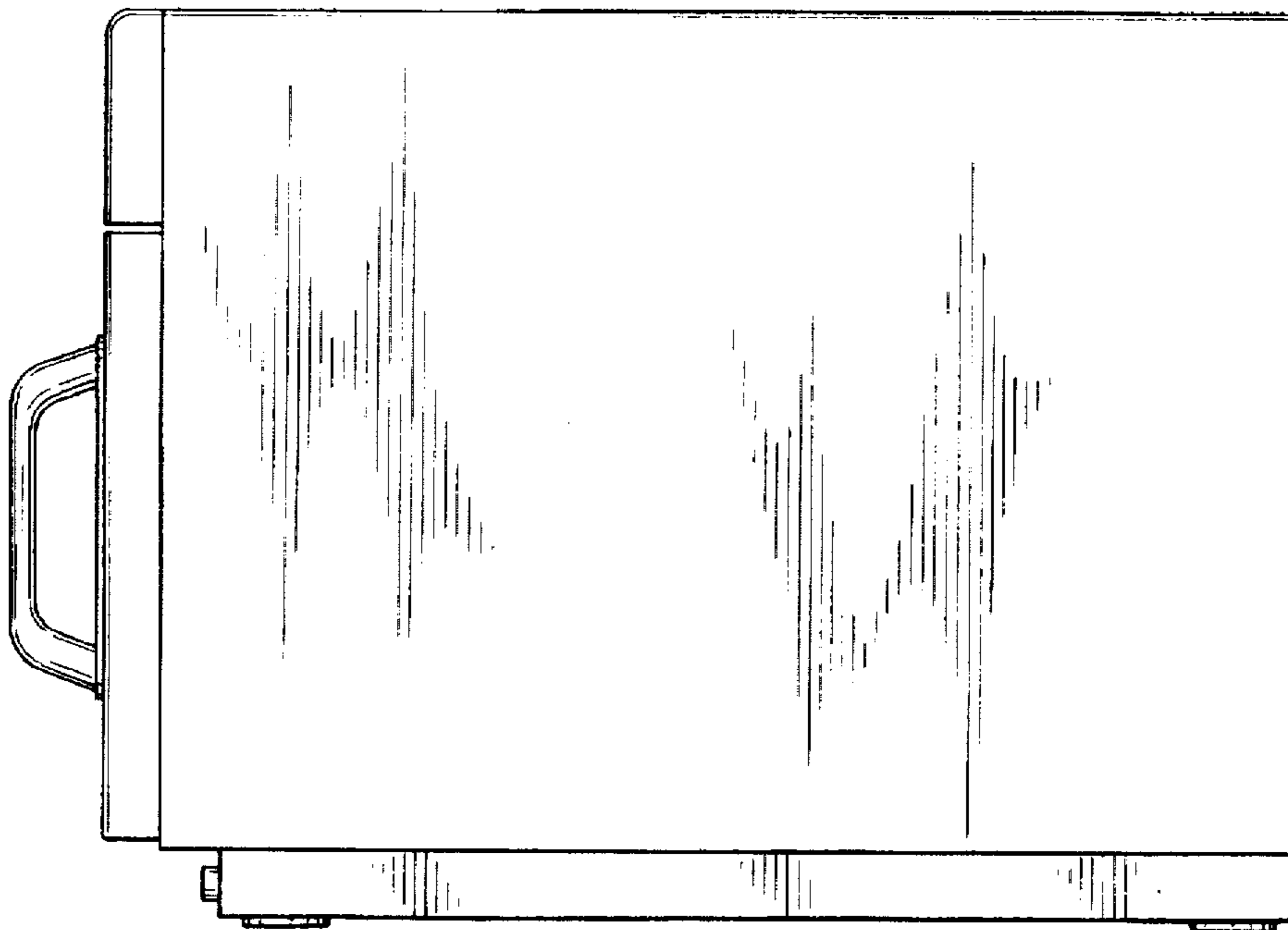

FIG. 5

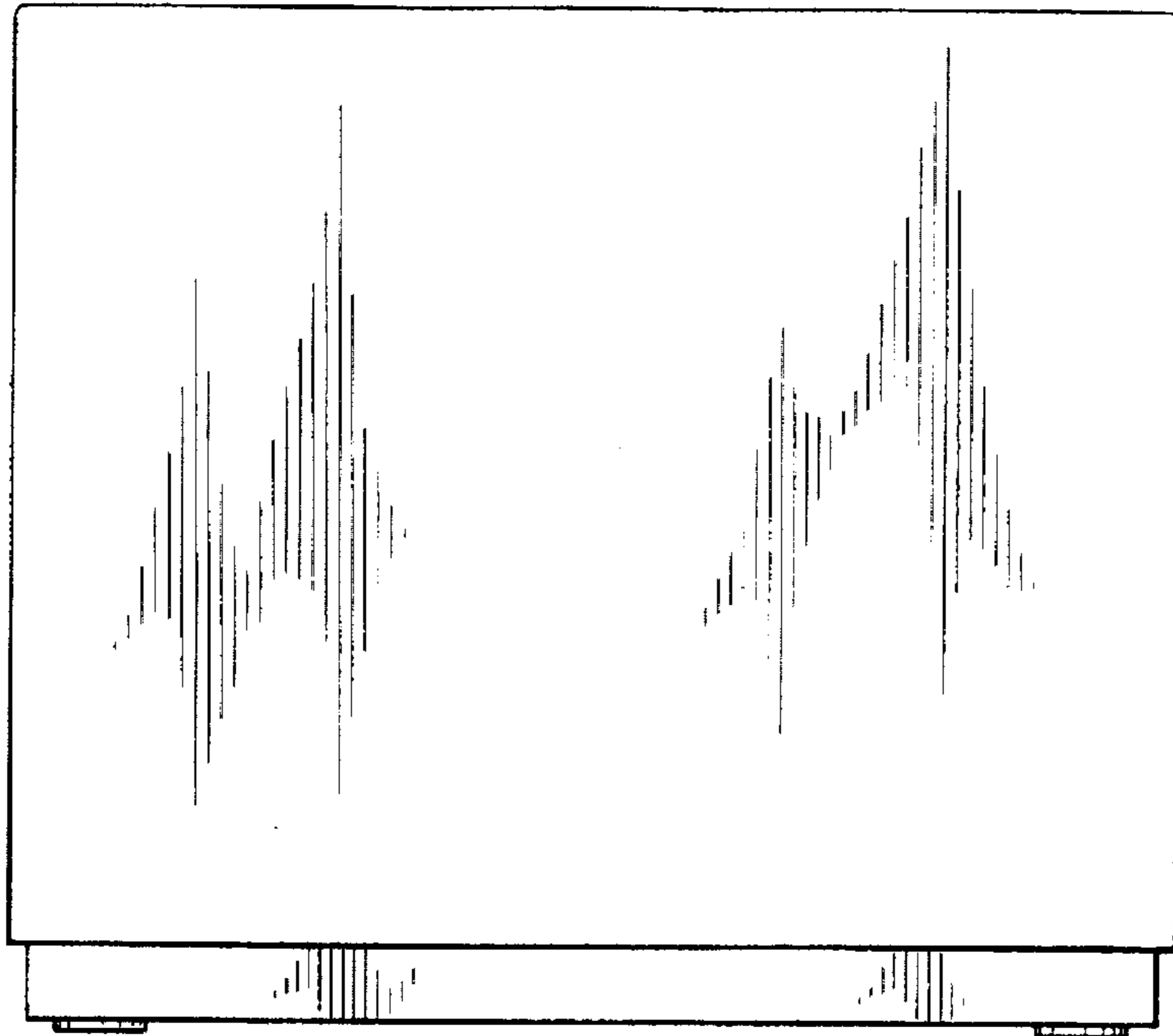

FIG. 6

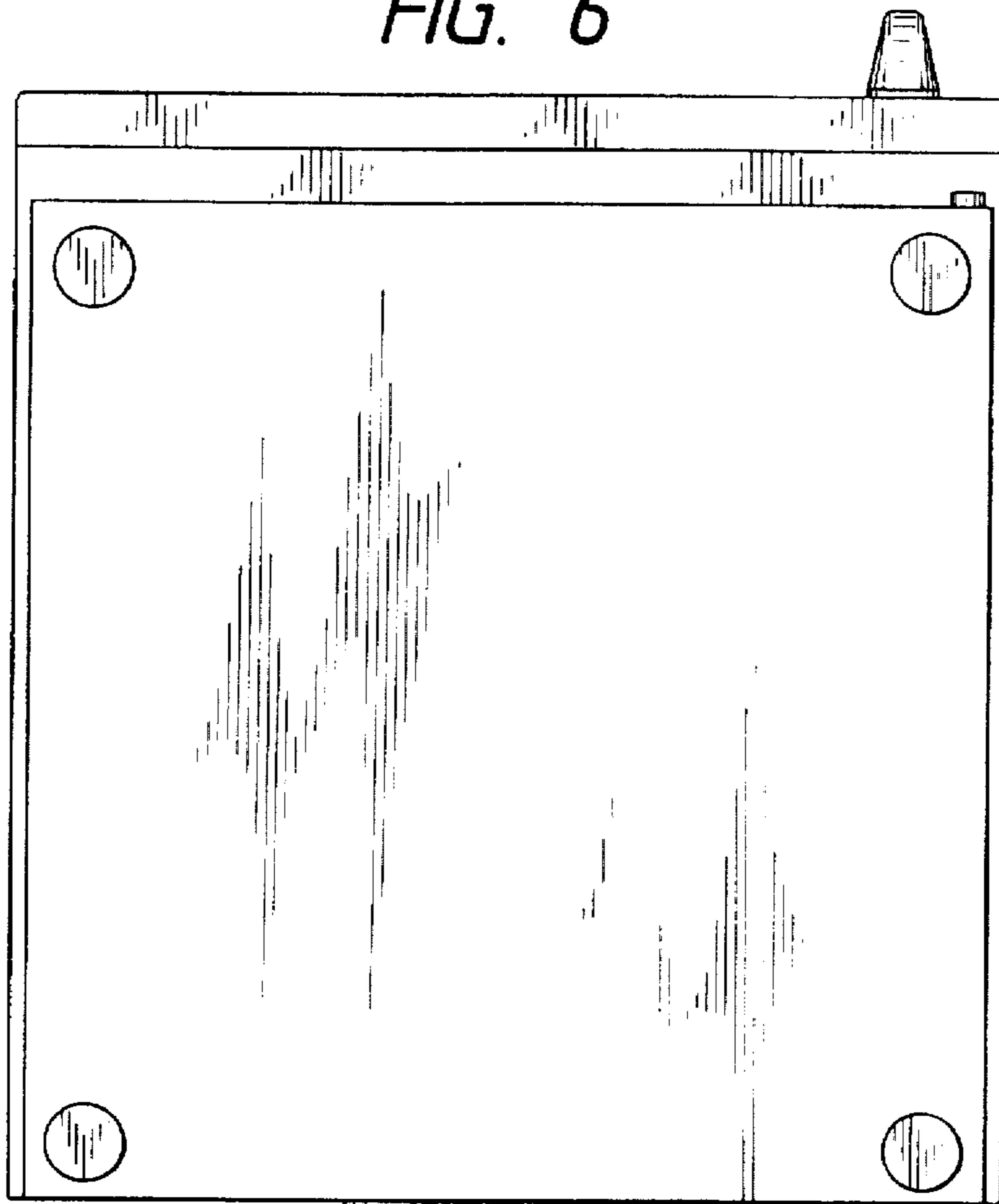

FIG. 7

