

US00D386351S

**United States Patent** [19]  
**Joergensen**

[11] **Patent Number: Des. 386,351**  
[45] **Date of Patent: \*\*Nov. 18, 1997**

[54] **JUG WITH WATER FILTER**

[75] **Inventor: Carsten Joergensen, Kriens, Switzerland**

[73] **Assignee: PI-Design AG, Triengen, Switzerland**

[\*\*] **Term: 14 Years**

[21] **Appl. No.: 54,836**

[22] **Filed: May 23, 1996**

[30] **Foreign Application Priority Data**

Feb. 13, 1996 [DK] Denmark ..... 159/96

[51] **LOC (6) Cl. .... 07-01**

[52] **U.S. Cl. .... D7/319; D7/318; D7/317**

[58] **Field of Search .... D7/300, 302, 312, D7/316, 317, 318, 319, 320, 322, 321, 309, 622, 590, 591; 220/718, 771; 222/465.1; D23/209**

[56] **References Cited**

**U.S. PATENT DOCUMENTS**

- D. 331,446 12/1992 Gidman ..... D23/209
- D. 336,760 6/1993 Jorgensen ..... D7/317
- D. 343,333 1/1994 Joegensen ..... D7/317
- D. 343,760 2/1994 Lin ..... D7/318

- D. 372,627 8/1996 Ireland ..... D7/319
- 1,782,962 11/1930 Hobbs ..... D7/622 X
- 4,365,544 12/1982 Howitt ..... D7/317 X

**OTHER PUBLICATIONS**

Brita Ultra II Water Filter, The Washington Post, Dec. 7, 1994.

*Primary Examiner*—M. N. Pandozzi  
*Attorney, Agent, or Firm*—Merchant, Gould, Smith, Edell, Welter & Schmidt, P.A.

[57] **CLAIM**

The ornamental design for a jug with water filter, as shown and described.

**DESCRIPTION**

- FIG. 1 is an oblique perspective view of the jug with water filter;
- FIG. 2 is a right side view of the jug with water filter, as shown in FIG. 1;
- FIG. 3 is a left side view of the jug with water filter;
- FIG. 4 is a front side view of the jug with water filter;
- FIG. 5 is a back side view of the jug with water filter;
- FIG. 6 is a top view of the jug with water filter; and,
- FIG. 7 is a bottom view of the jug with water filter.

**1 Claim, 7 Drawing Sheets**

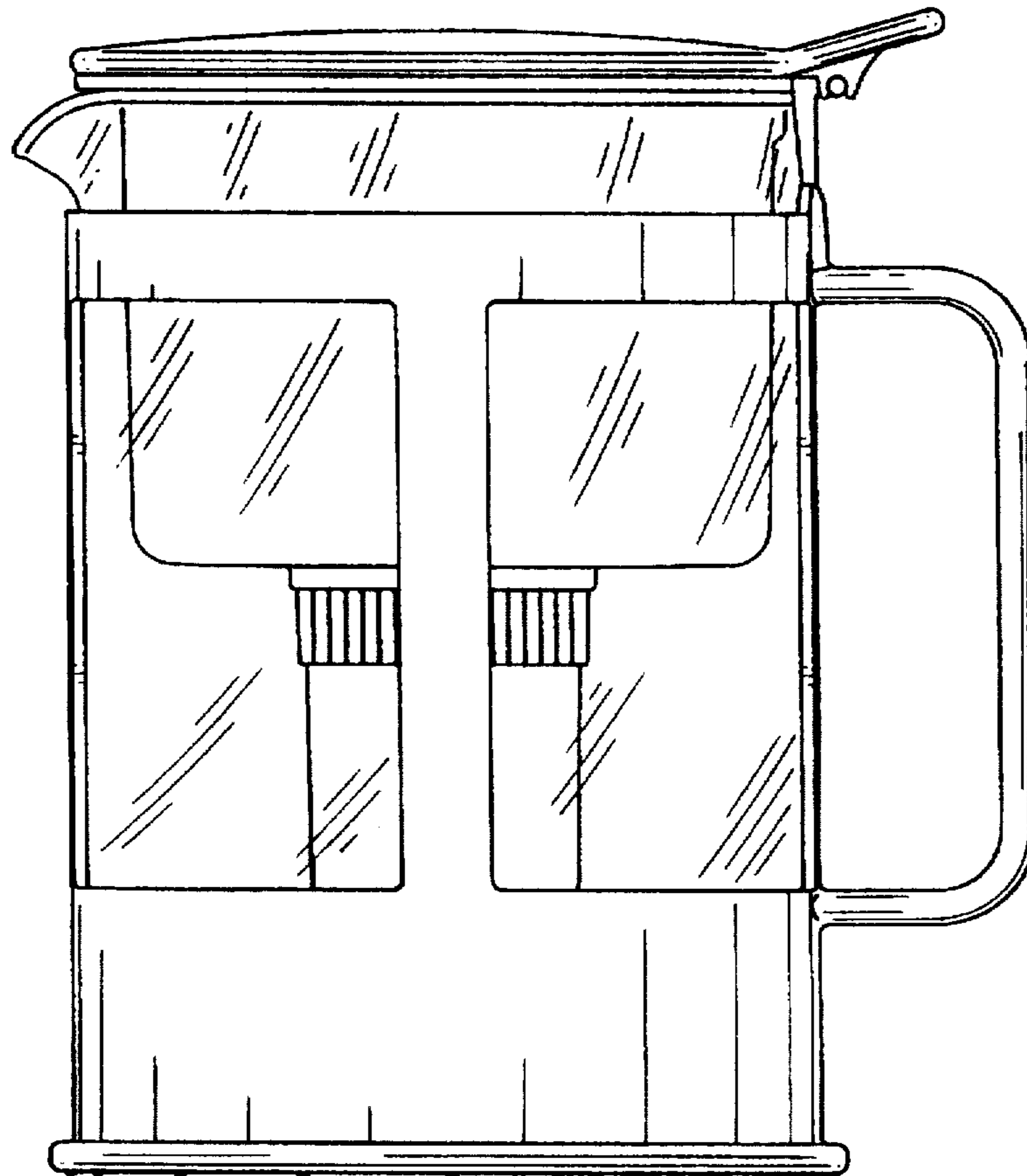

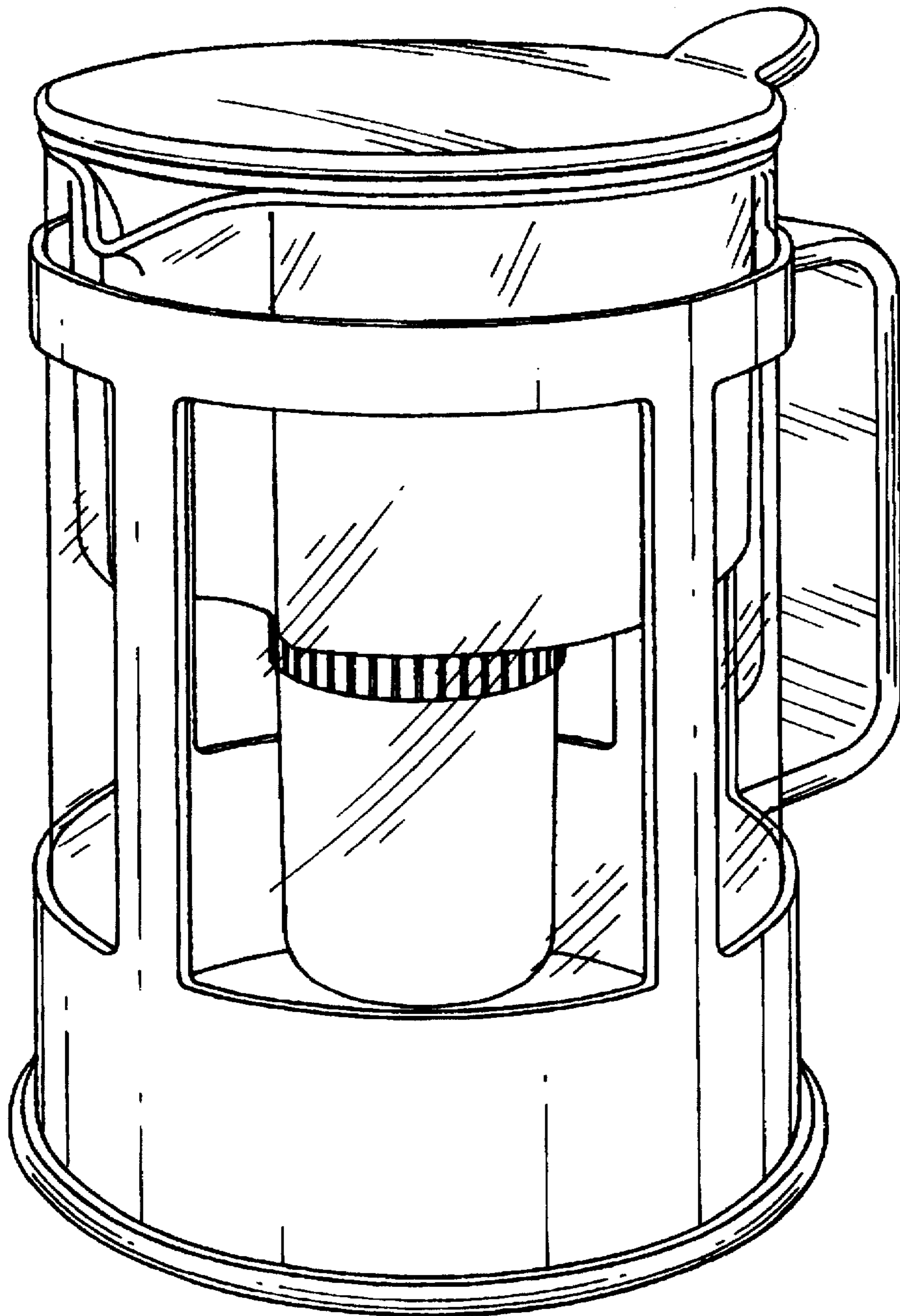

Fig. 1

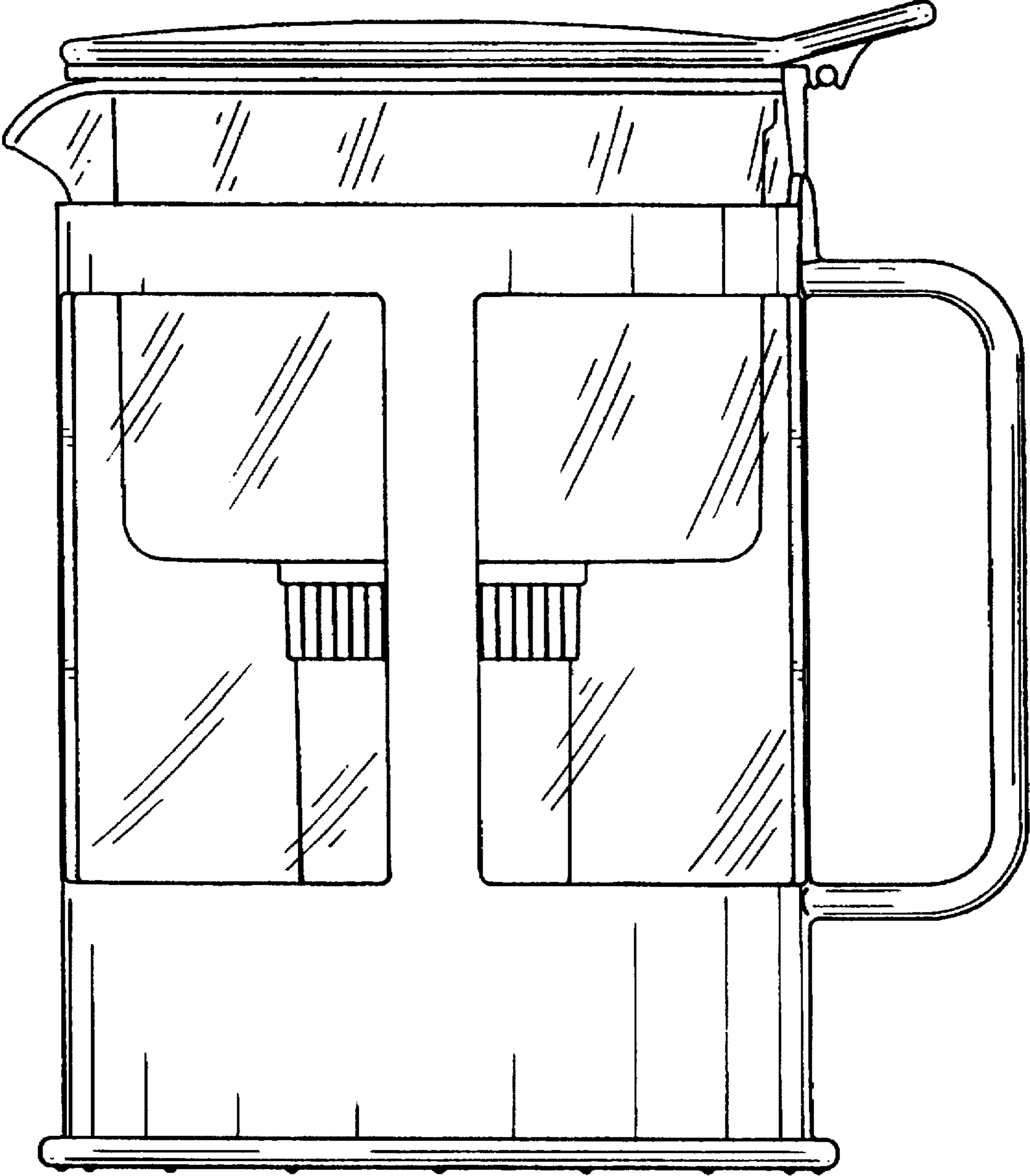

Fig. 2

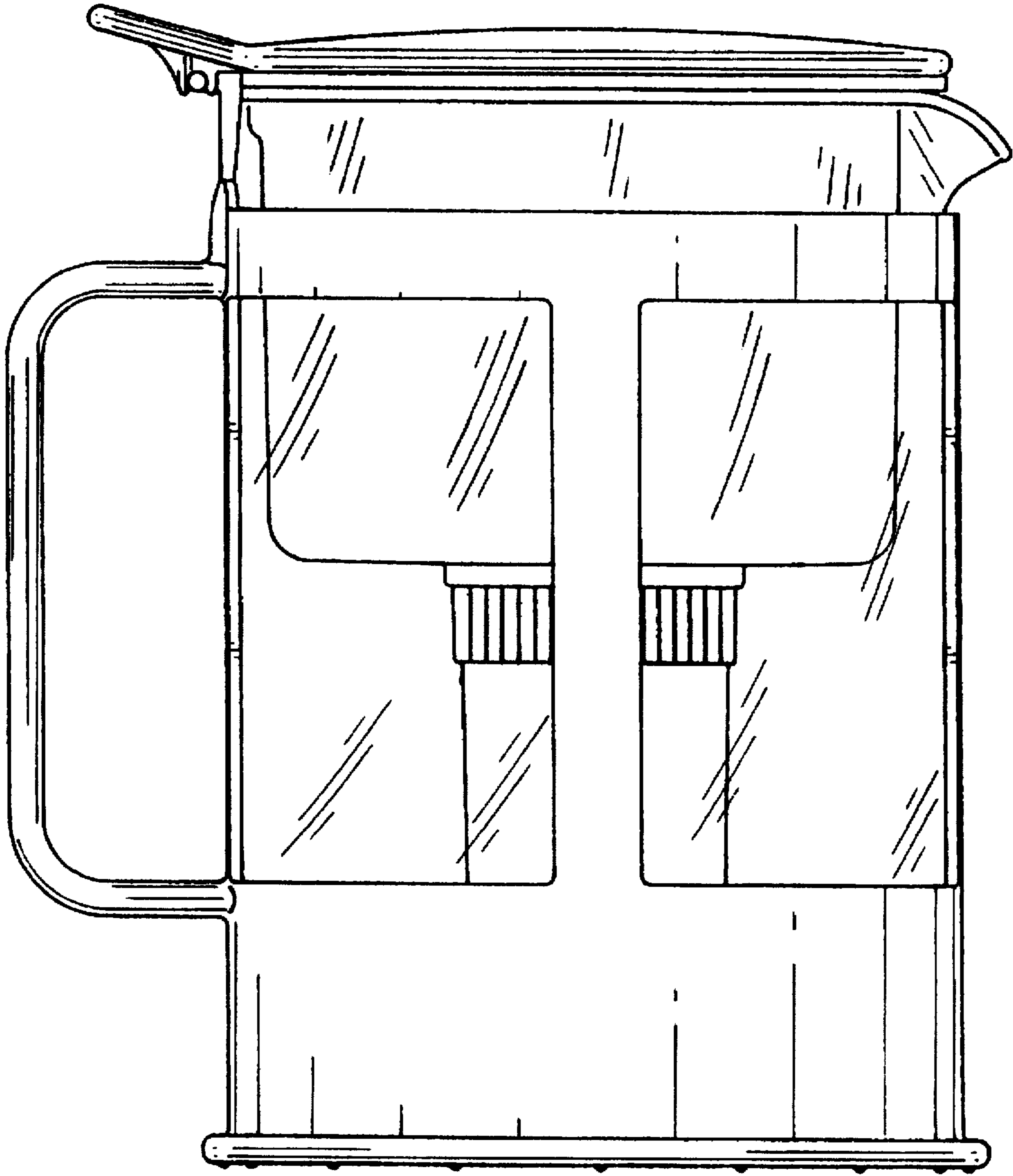

Fig. 3

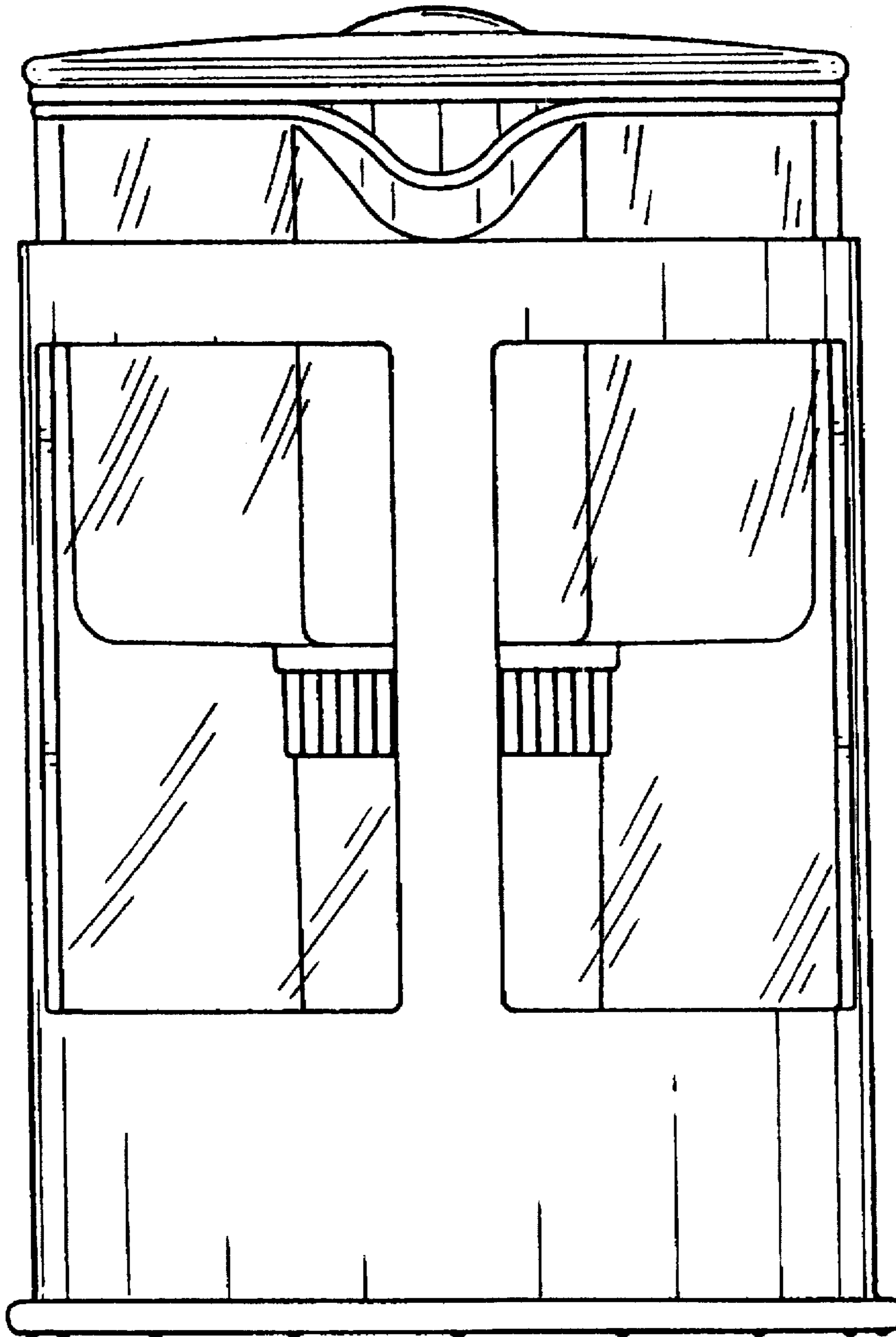

Fig. 4

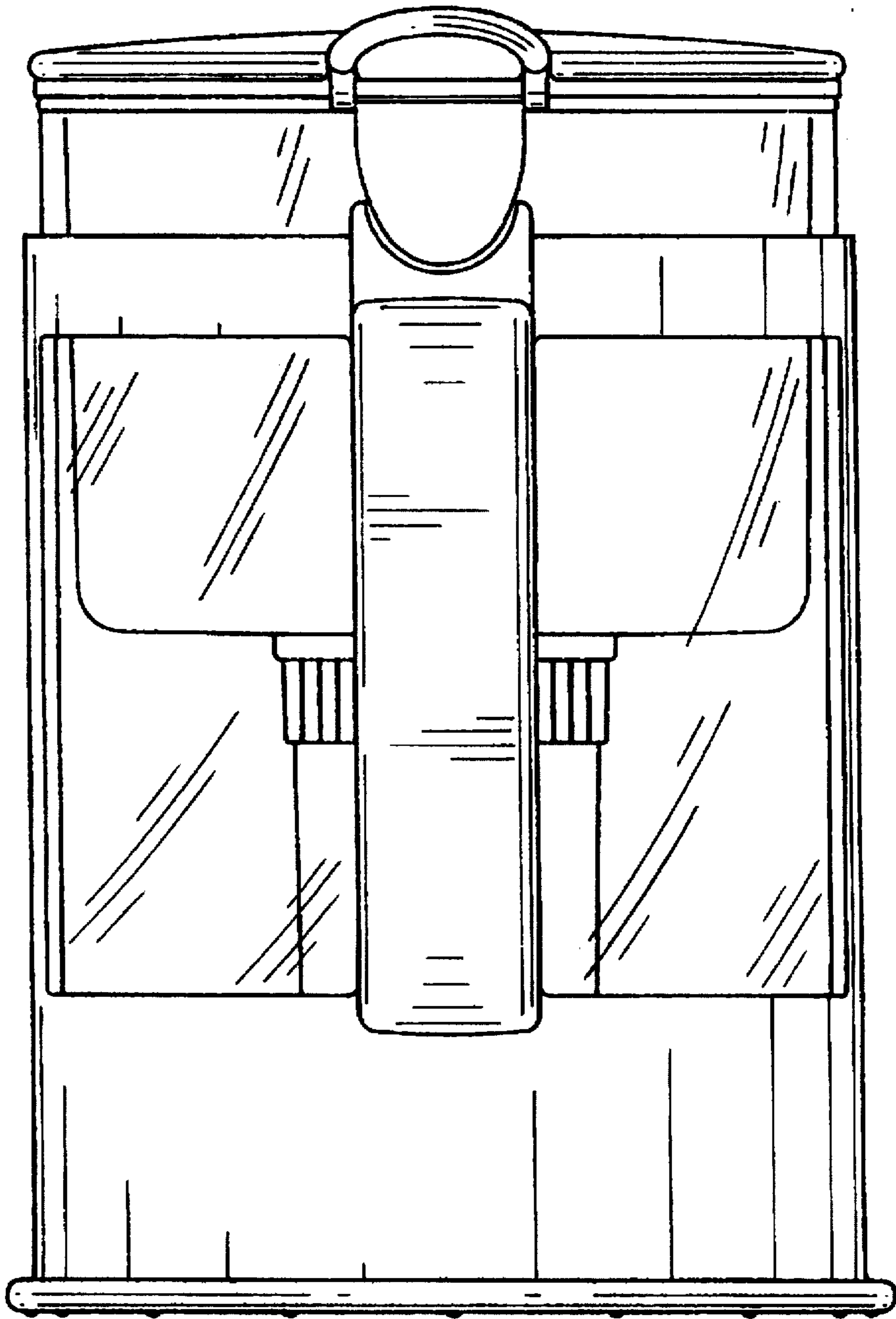
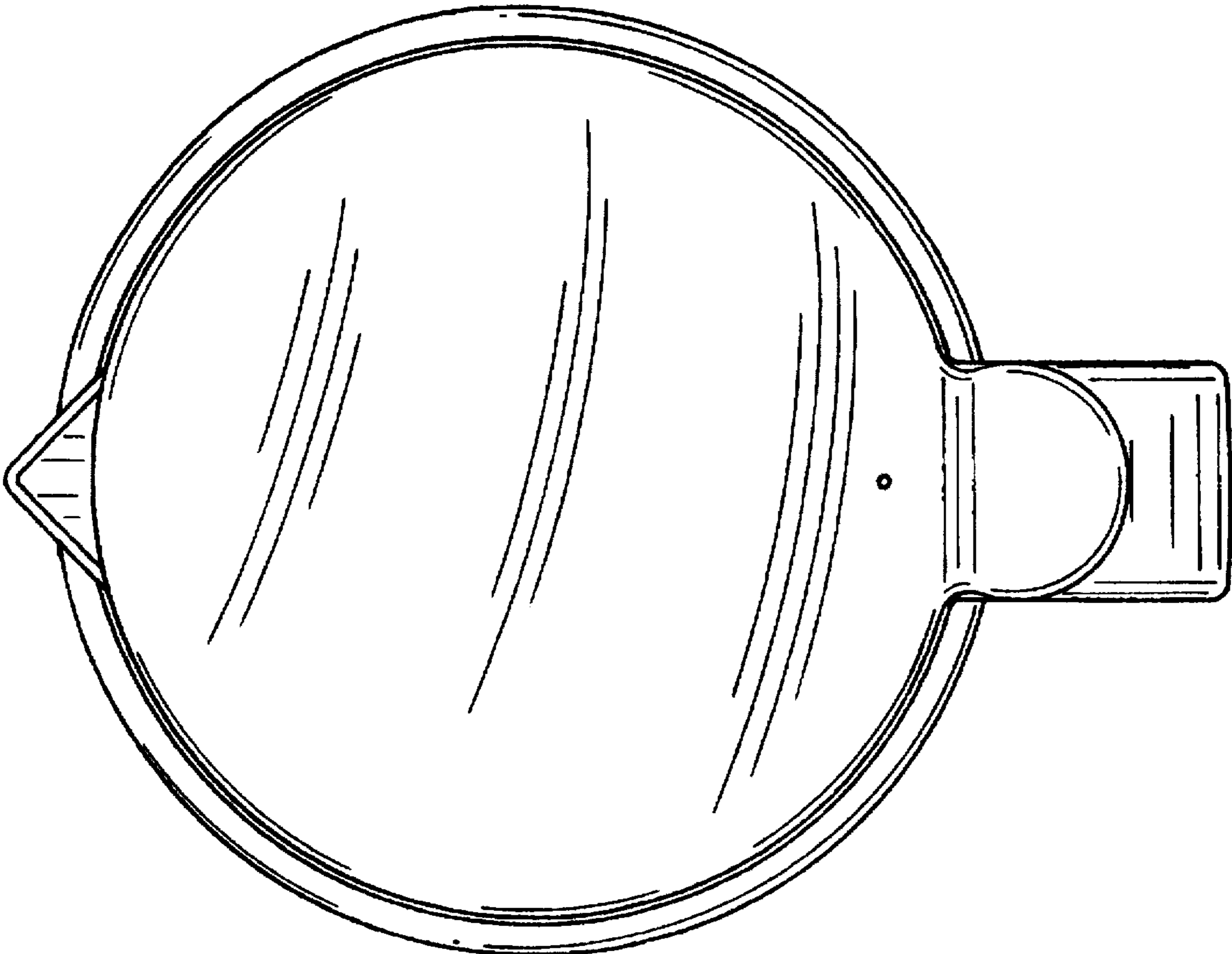
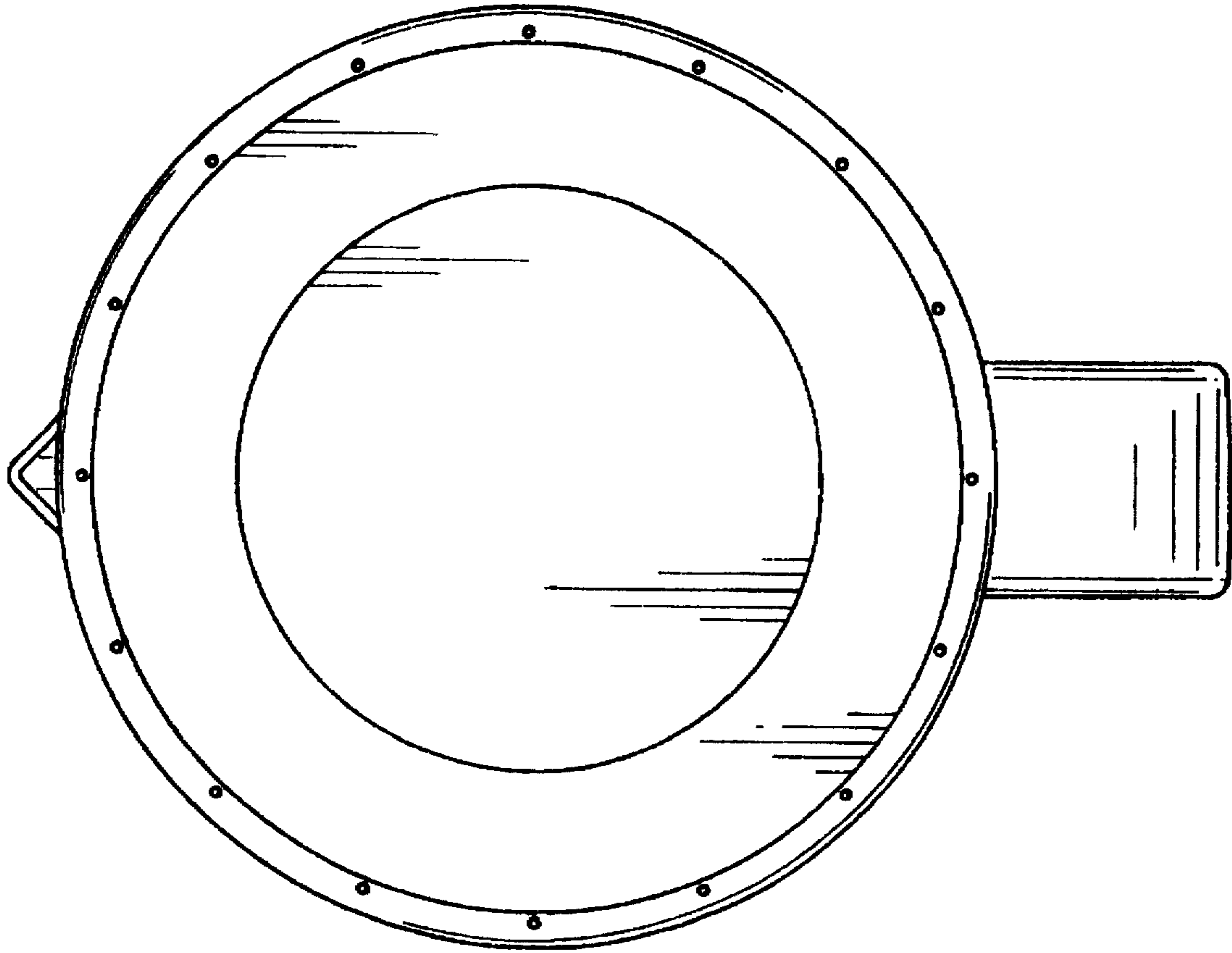

Fig. 5



**Fig. 6**



**Fig. 7**