

US00D386323S

United States Patent [19]

Davis

[11] Patent Number: Des. 386,323

[45] Date of Patent: **Nov. 18, 1997

[54] **GROUND INSERTED UMBRELLA SUPPORT**

[76] Inventor: **J. C. Davis**, 509 Hanson St., Arvin, Calif. 93203

[**] Term: **14 Years**

[21] Appl. No.: **54,021**

[22] Filed: **May 6, 1996**

[51] LOC (6) Cl. **06-06**

[52] U.S. Cl. **D6/417**

[58] Field of Search D6/396, 416, 417; 211/62, 63; 135/16, 118; 248/156, 533, 530, 545

[56] **References Cited**

U.S. PATENT DOCUMENTS

D. 325,678	4/1992	Niles	D6/417
D. 364,286	11/1995	Loadholtz	D6/417
2,877,828	3/1959	Barnette, Jr.	248/533
3,823,785	7/1974	Toliver	248/156 X

4,874,149	10/1989	Miceli	248/530
5,349,775	9/1994	Mondares	248/530 X
5,396,743	3/1995	Bellette	248/545 X

Primary Examiner—Carmen H. Vales-Lado

[57] **CLAIM**

The ornamental design for a ground inserted umbrella support, as shown and described.

DESCRIPTION

FIG. 1 is a front elevational view of a ground inserted umbrella support showing my new design;
 FIG. 2 is a rear elevational view thereof;
 FIG. 3 is a left elevational view with the right side being a mirror image thereof;
 FIG. 4 is a top plan view thereof;
 FIG. 5 is a bottom plan view thereof; and,
 FIG. 6 is a front elevational view with an umbrella shown in broken lines for illustrative purposes only and forms no part of the claimed design.

1 Claim, 2 Drawing Sheets

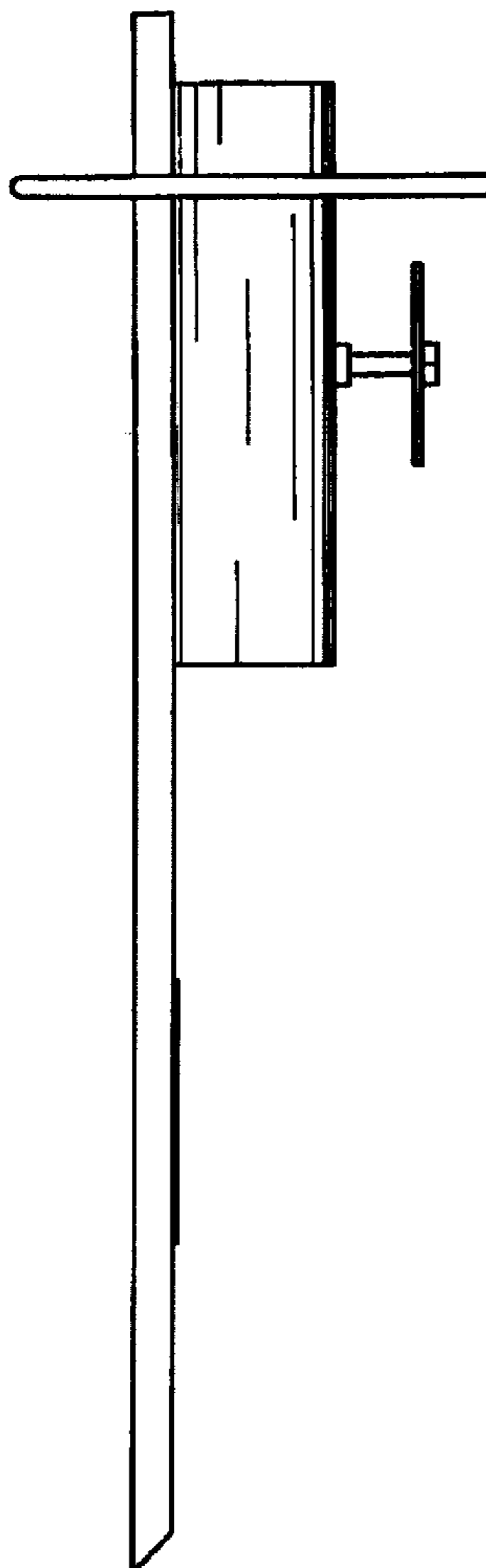
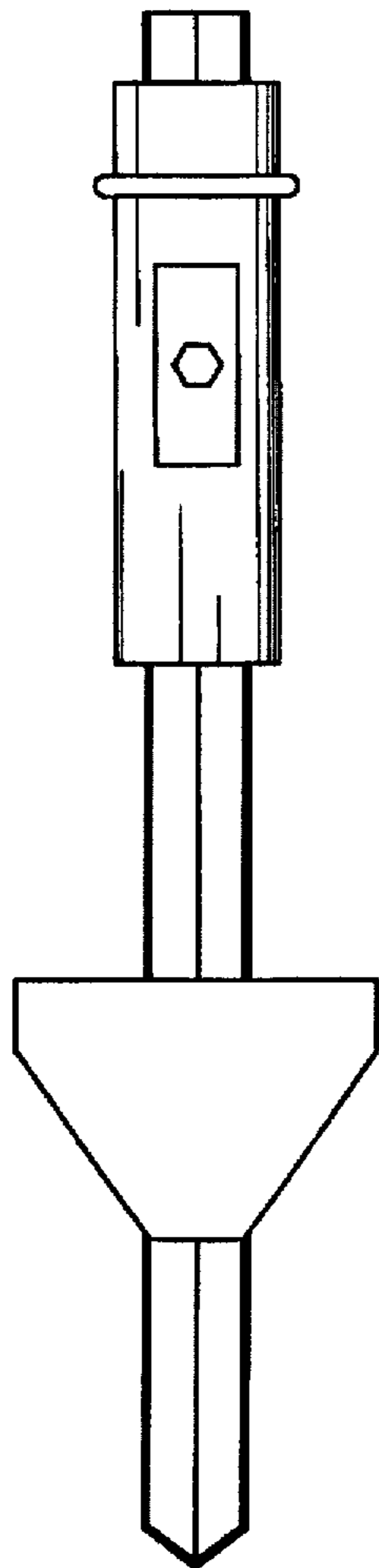

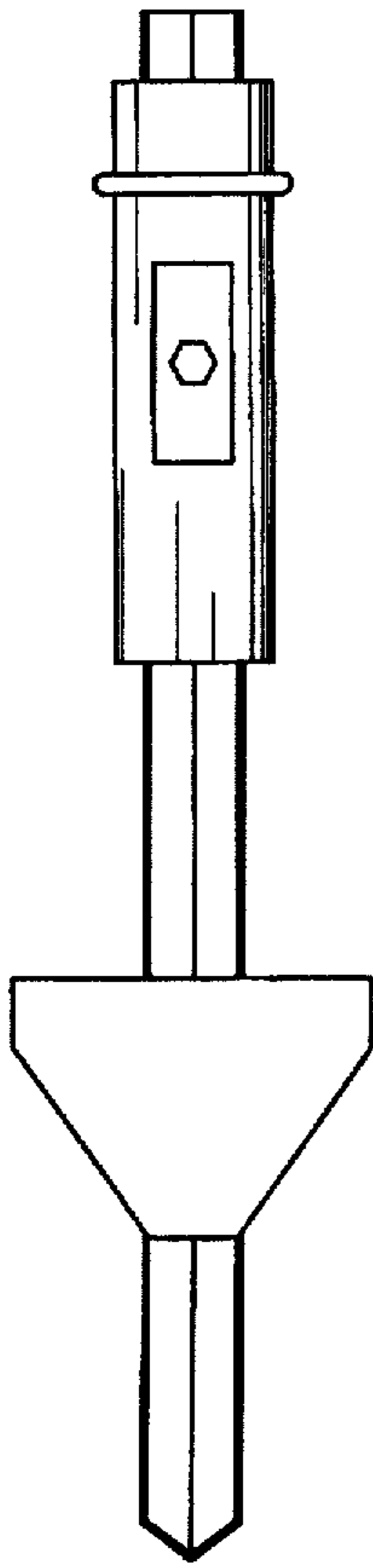

FIGURE 1

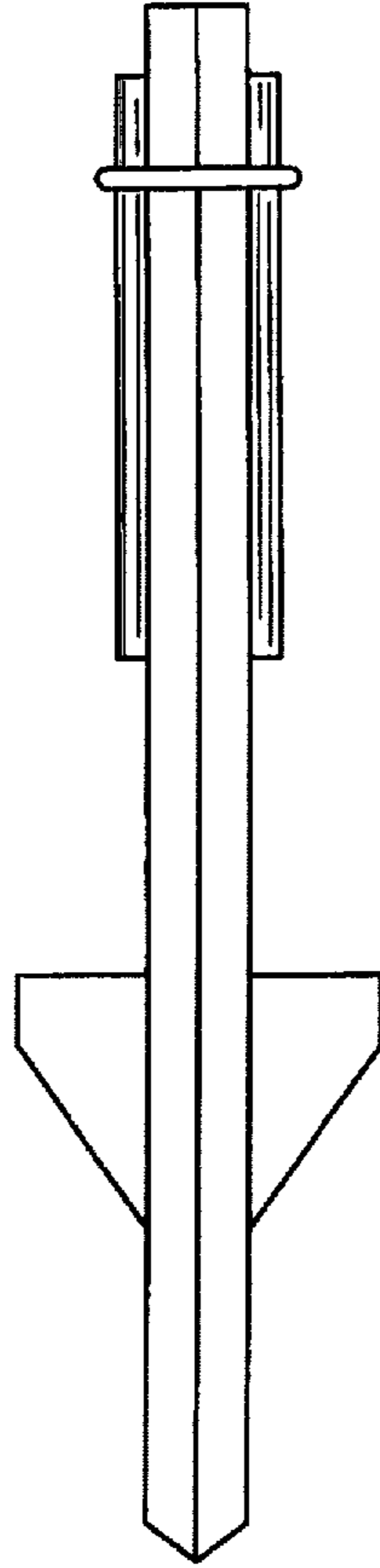

FIGURE 2

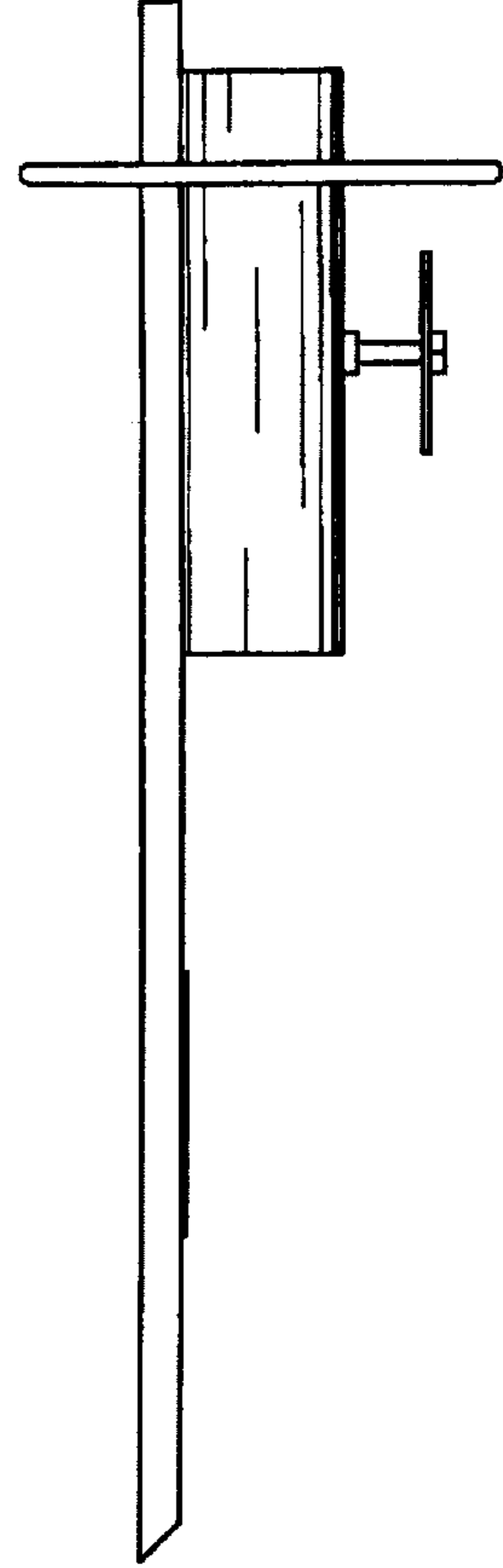

FIGURE 3

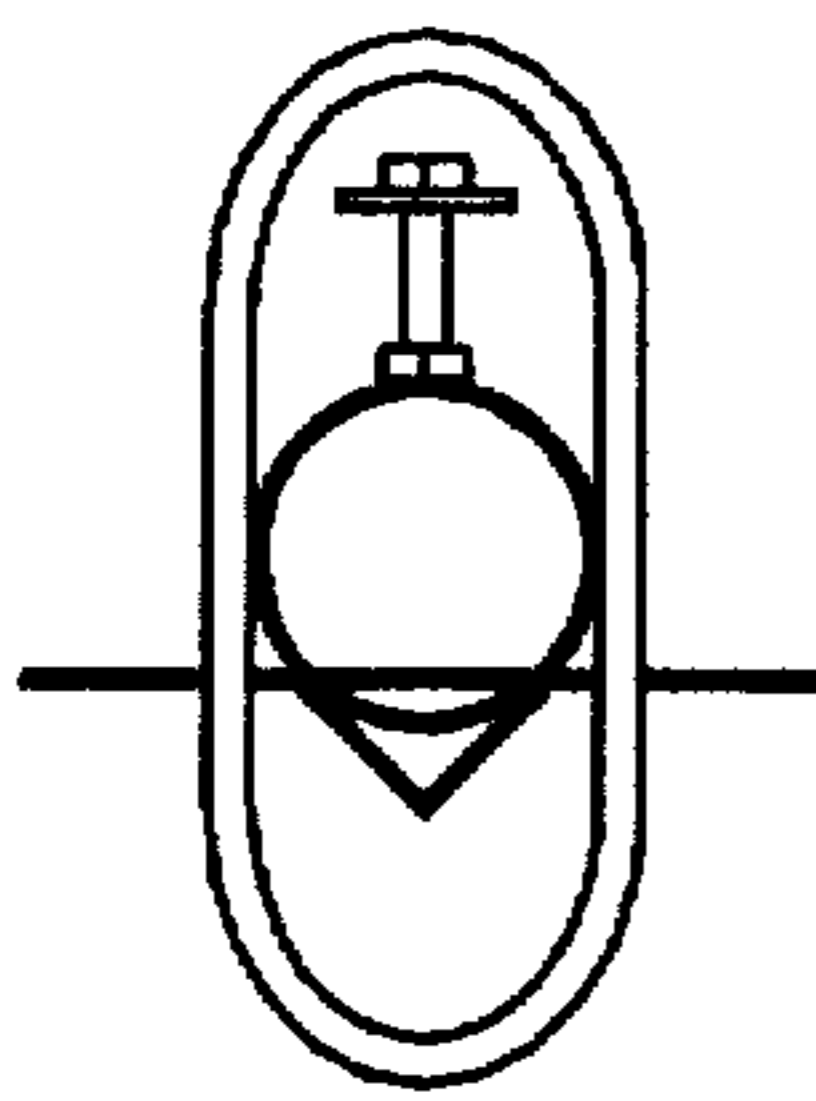

FIGURE 4

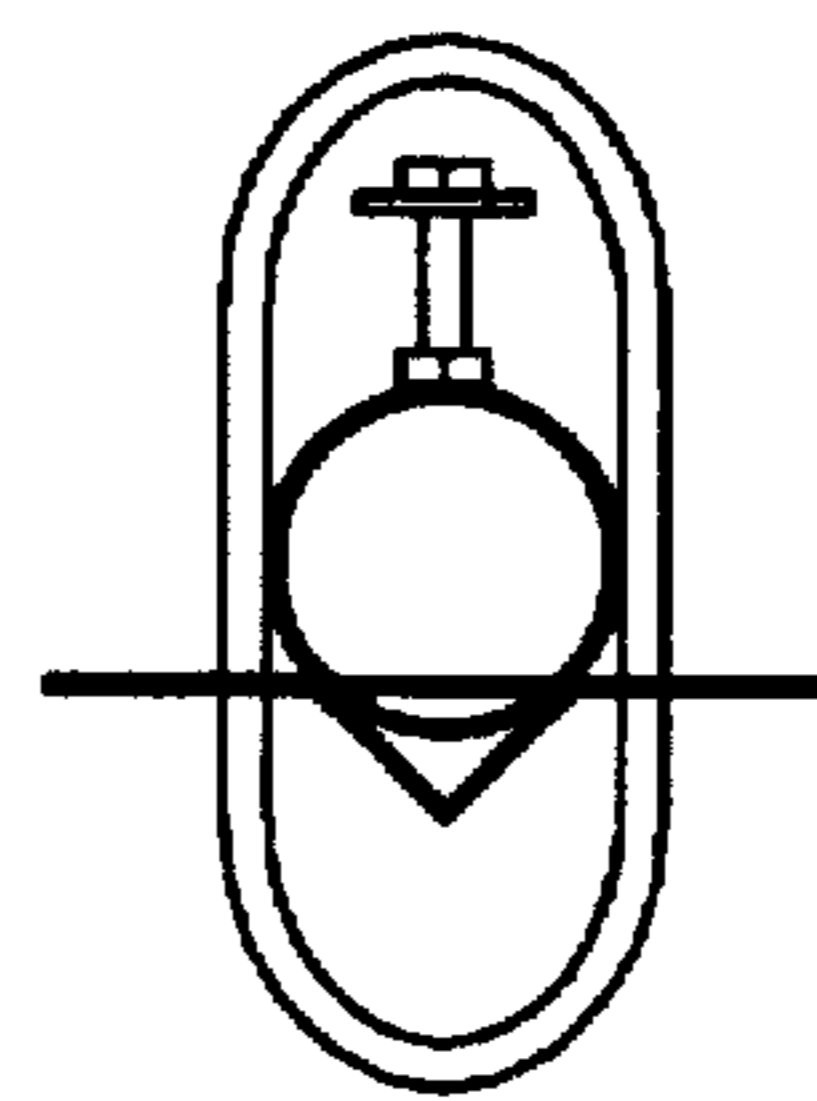

FIGURE 5

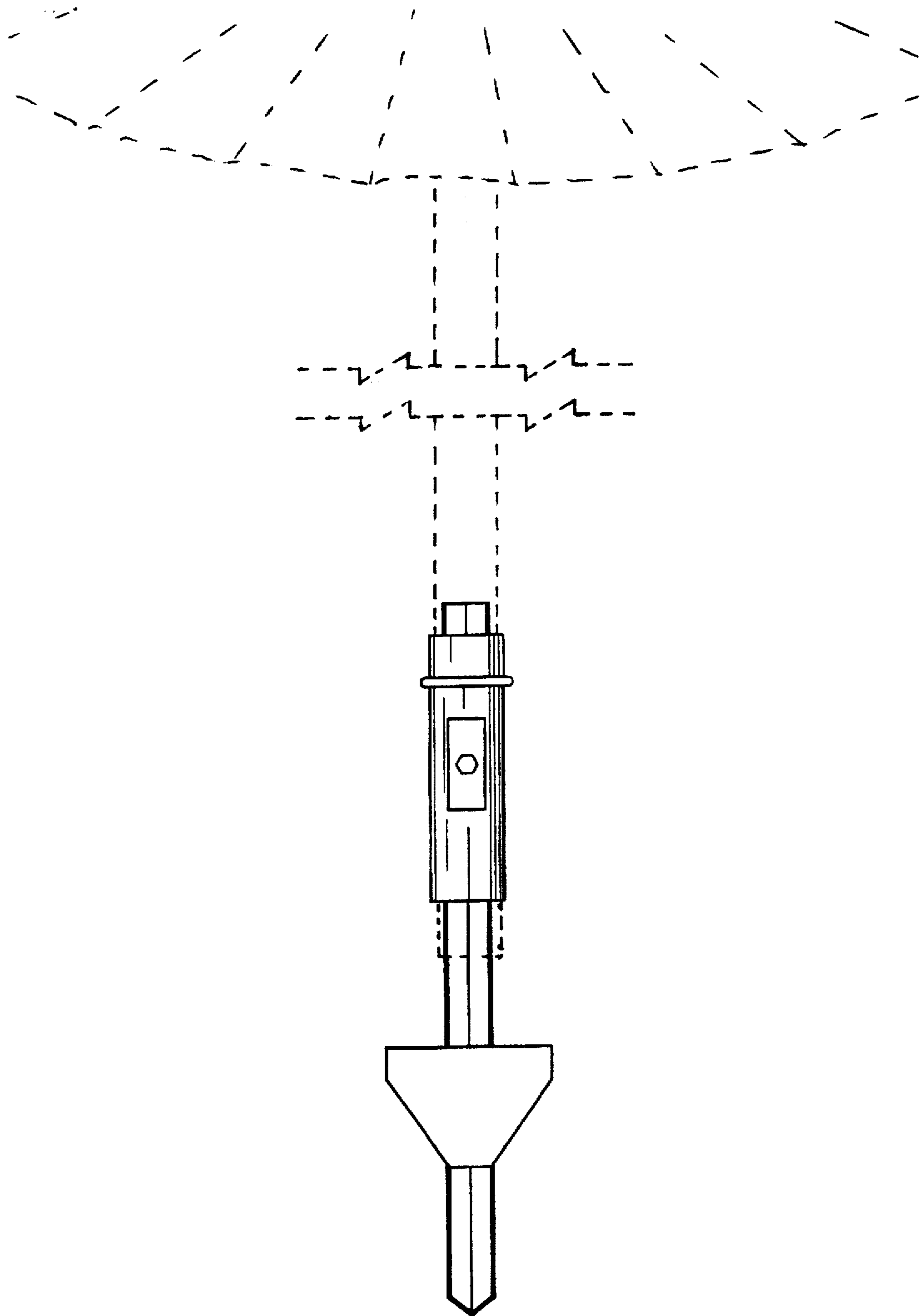

FIGURE 6