



US00D386264S

# United States Patent [19]

[11] Patent Number: **Des. 386,264**

Stillwell et al.

[45] Date of Patent: **\*\*Nov. 11, 1997**

## [54] ROOF TOP FOR BOX WINDOWS

## OTHER PUBLICATIONS

[76] Inventors: **Mark E. Stillwell**, 371 Greendale Way, Redwood City, Calif. 94062; **Michael R. O'Connor**, 1546 Notre Dame Ave., Belmont, Calif. 94002

Deco-Roof advertising, Jan., 1994.

*Primary Examiner*—Doris Clark  
*Attorney, Agent, or Firm*—Feix & Feix

[\*\*] Term: **14 Years**

## [57] CLAIM

[21] Appl. No.: **56,812**

The ornamental design for a roof top for box windows, as shown and described.

[22] Filed: **Jul. 9, 1996**

## DESCRIPTION

[51] LOC (6) Cl. .... **25-02**

[52] U.S. Cl. .... **D25/57; D25/57**

[58] Field of Search ..... D25/57, 52, 139-141;  
52/73-74, 90.1-90.2, 201

FIG. 1 is a front perspective view of the roof top for box windows of the present invention;

FIG. 2 is a rear perspective view thereof;

FIG. 3 is a top plan view thereof;

FIG. 4 is a bottom plan view thereof;

FIG. 5 is a left side elevational view thereof, the right side elevational view being a mirror image;

FIG. 6 is a front elevational view thereof; and,

FIG. 7 is a rear elevational view thereof.

The broken lines showing the box window is for illustrative purposes only and forms no part of the claimed design.

## [56] References Cited

### U.S. PATENT DOCUMENTS

D. 134,337	11/1942	Cutshall .	
D. 331,468	12/1992	Hirabayashi et al. ....	D25/52
D. 359,131	6/1995	Stillwell et al. ....	D25/57
D. 359,132	6/1995	Stillwell et al. ....	D25/57
D. 359,564	6/1995	Stillwell et al. ....	D25/57
2,862,260	12/1958	Bottom .....	D25/57
4,439,963	4/1984	Feiss .....	52/201
5,001,875	3/1991	Cacioppo .....	52/201

**1 Claim, 1 Drawing Sheet**

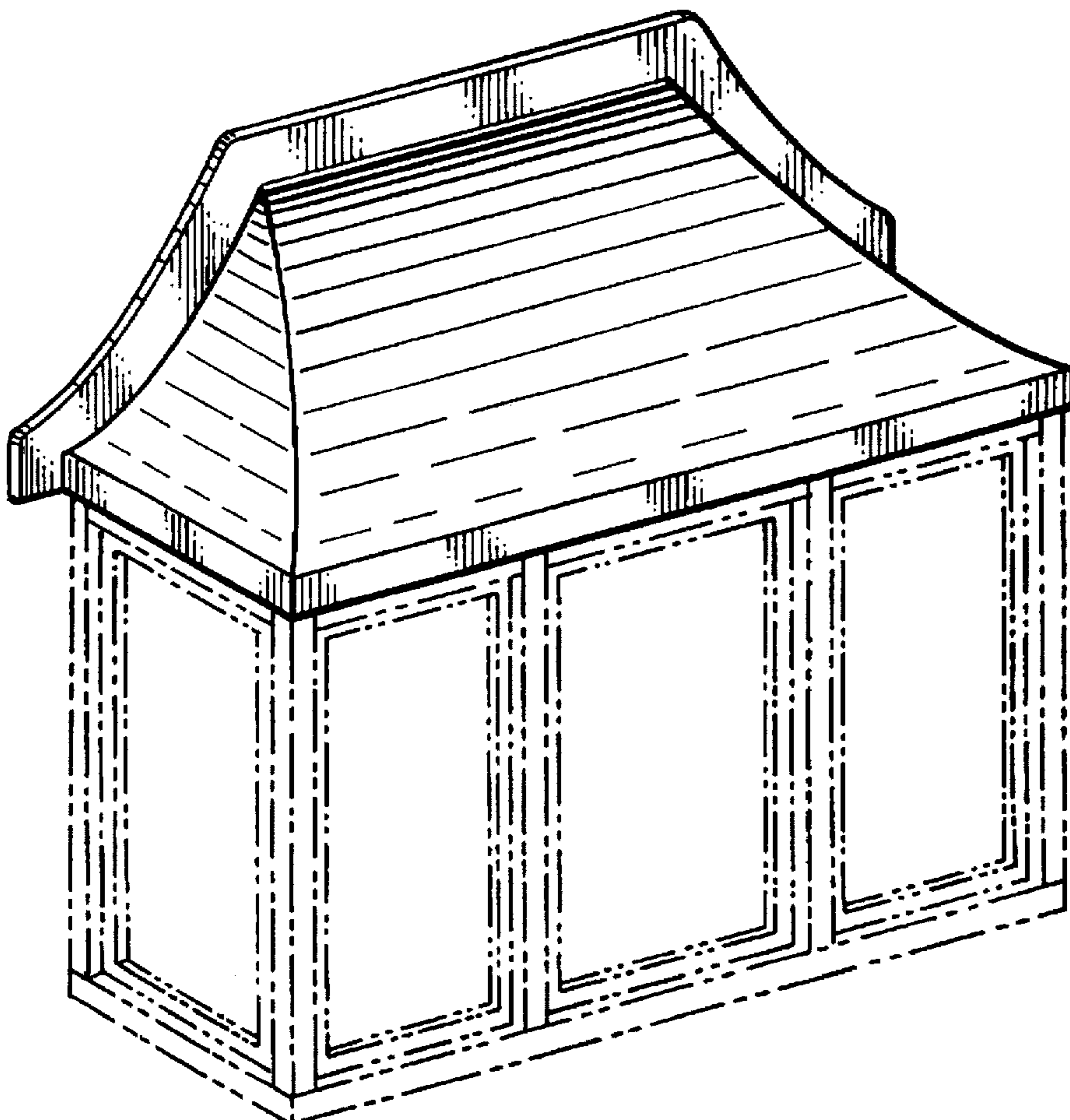

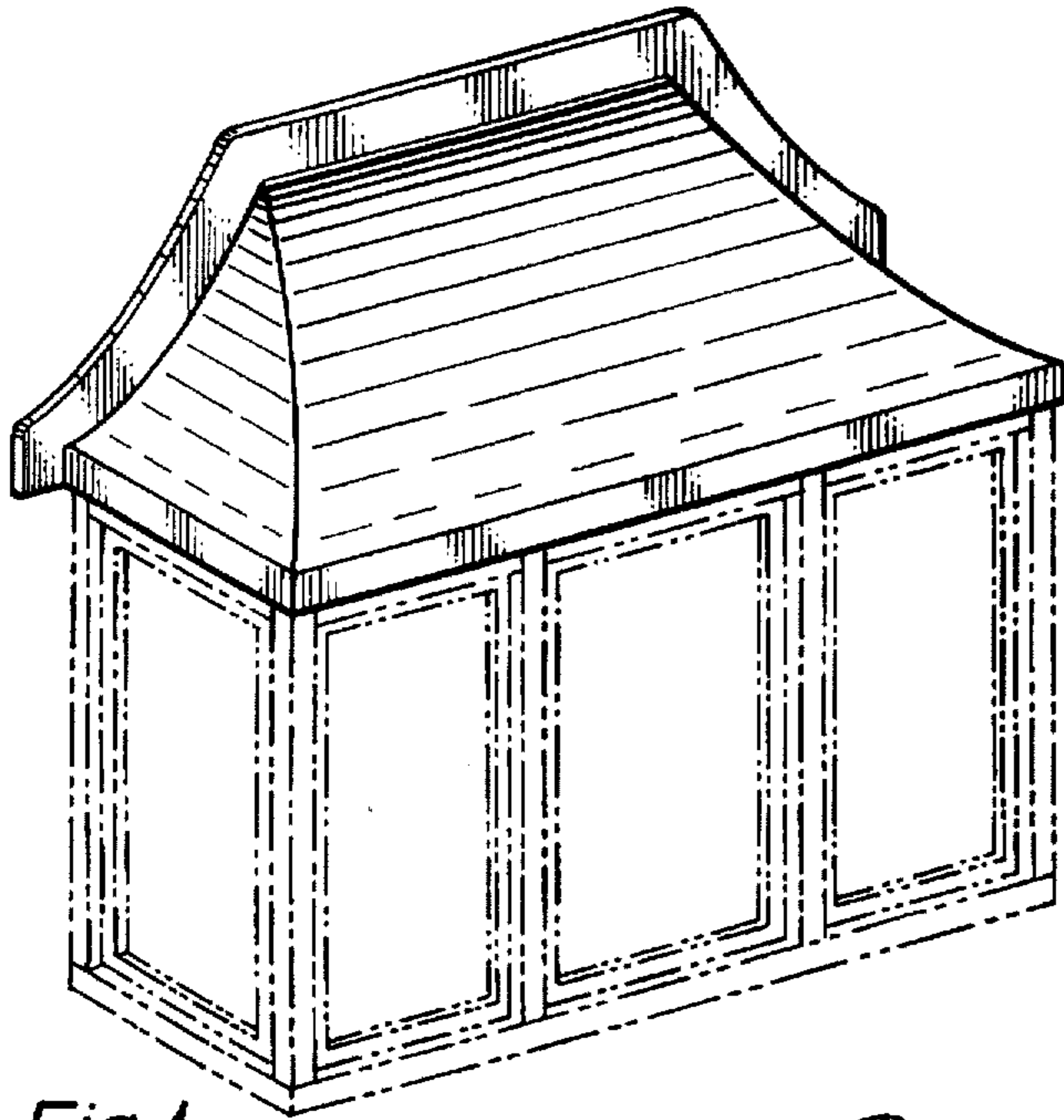

Fig. 1

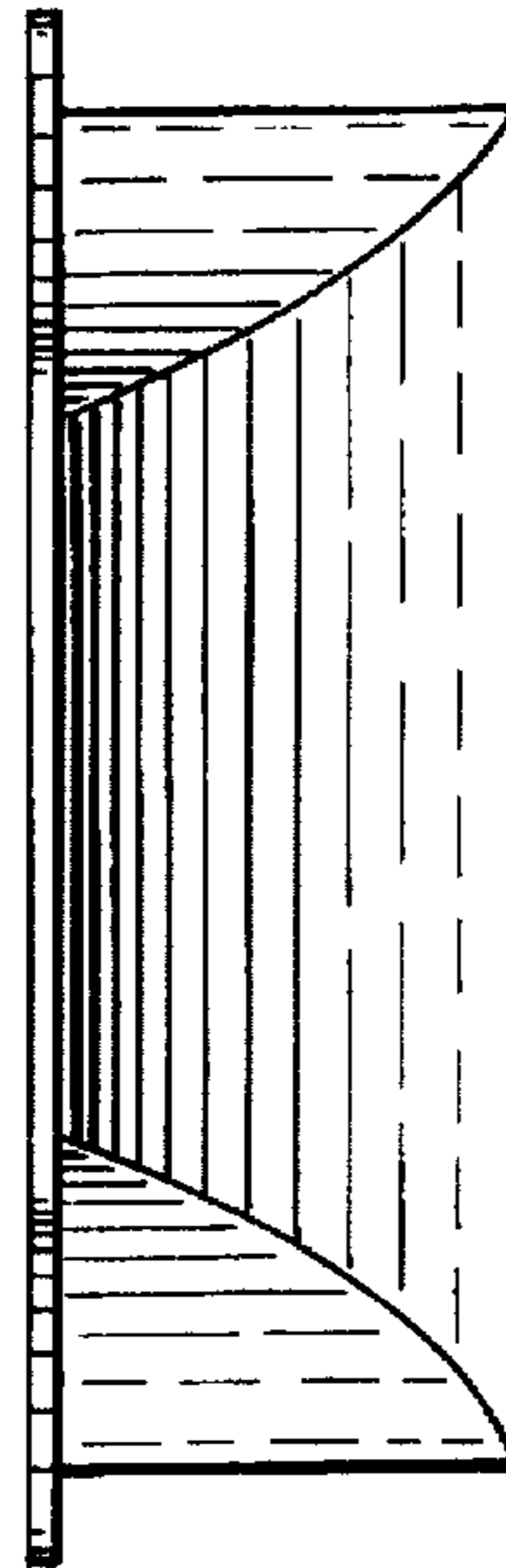

Fig. 3

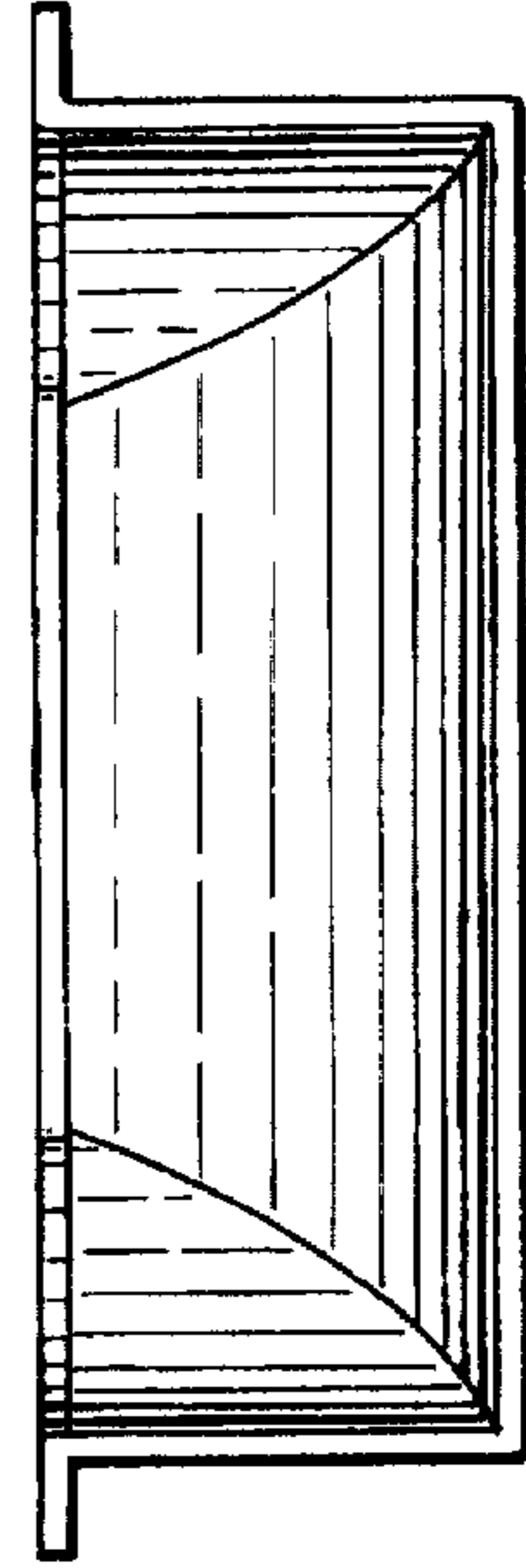

Fig. 4

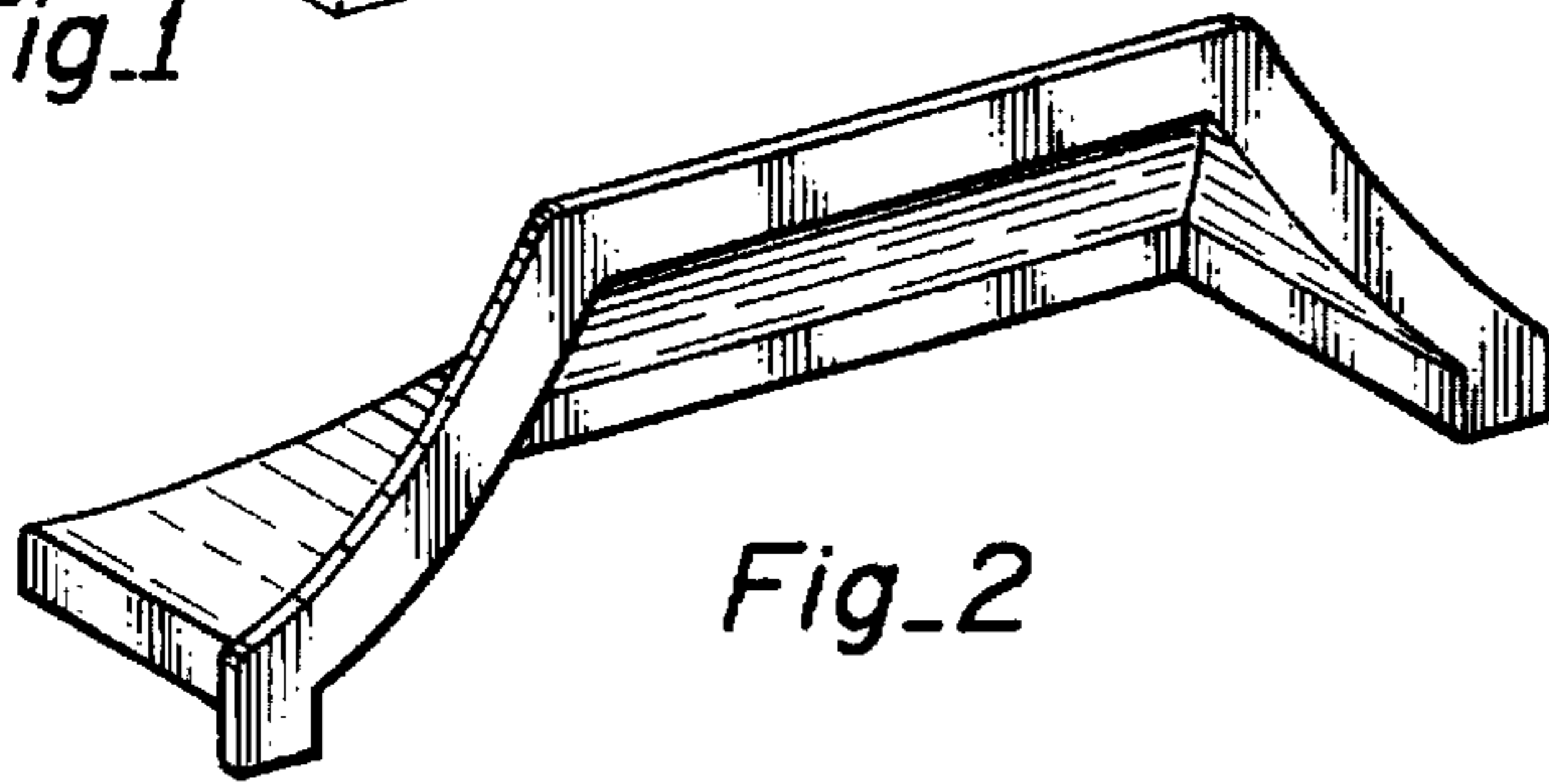

Fig. 2

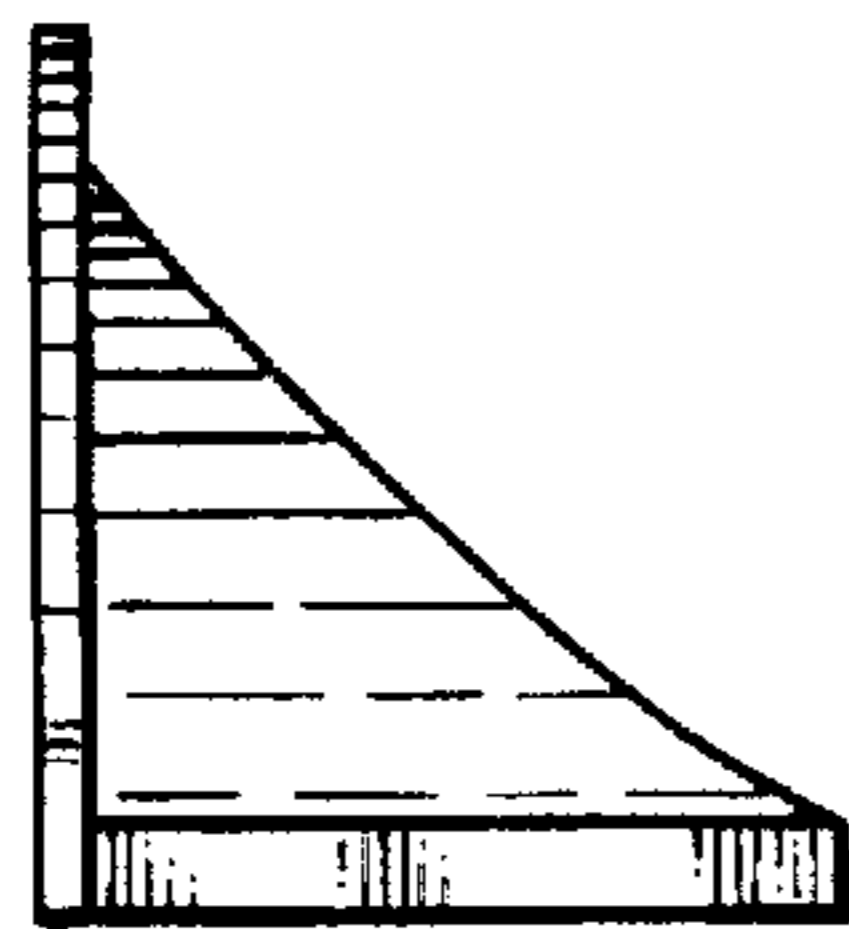

Fig. 5

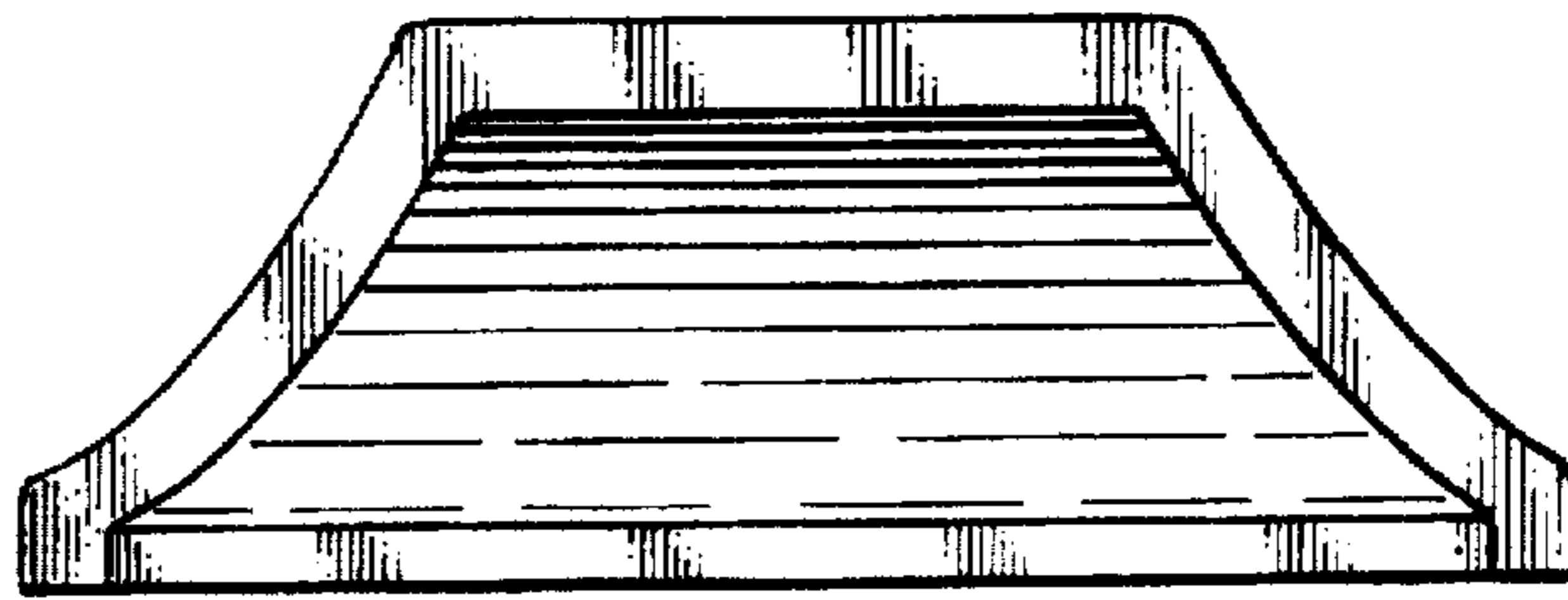

Fig. 6

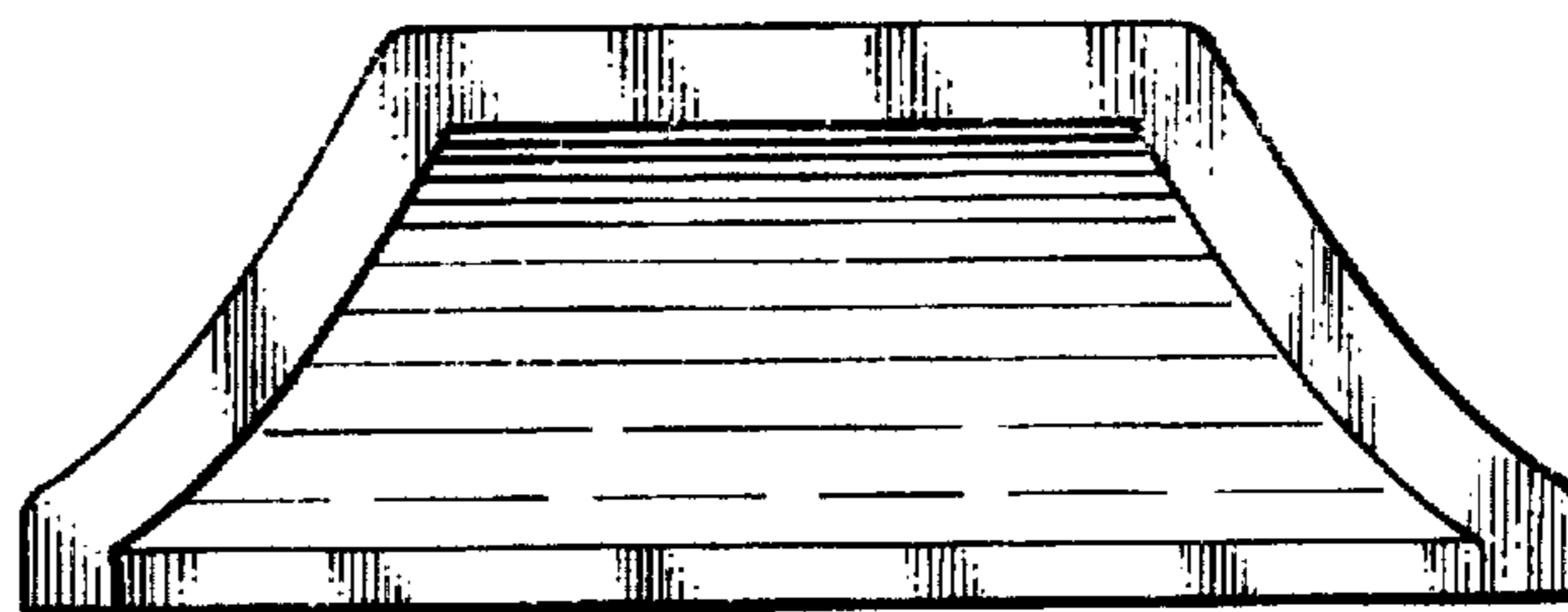

Fig. 7