



US00D386225S

United States Patent [19] Chen

[11] Patent Number: Des. 386,225
[45] Date of Patent: **Nov. 11, 1997

[54] EXERCISER

5,232,425 8/1993 Miller et al. 482/140
5,372,558 12/1994 Perry et al. 482/140

[76] Inventor: Ping Chen, No. 29, Nan-Mei St.,
Taichung City, Taiwan

Primary Examiner—Philip S. Hyder
Attorney, Agent, or Firm—Ladas & Parry

[**] Term: 14 Years

[57] CLAIM

[21] Appl. No.: 56,573

The ornamental design for an exerciser, as shown and described.

[22] Filed: Jul. 2, 1996

DESCRIPTION

[51] LOC (6) Cl. 21-02

[52] U.S. Cl. D21/191; D21/198

[58] Field of Search D21/191, 195,
D21/198; 482/140, 121, 122, 123, 124,
126, 128, 131

FIG. 1 is a perspective view of exerciser showing my new design;

FIG. 2 is a front elevational view thereof;

FIG. 3 is a rear elevational view thereof;

FIG. 4 is a left side elevational view thereof;

FIG. 5 is a right side elevational view thereof;

FIG. 6 is a top plan view thereof;

FIG. 7 is a bottom plan view thereof; and,

FIG. 8 is a left side elevational view thereof, wherein the broken line showing of the person and chair are for illustrative purposes only and form no part of the claimed design.

[56] References Cited

U.S. PATENT DOCUMENTS

4,834,366	5/1989	Hotchkiss	482/128
5,046,726	9/1991	Van Straaten	482/128
5,050,875	9/1991	Lewkovich	482/128
5,122,107	6/1992	Gardner	482/140
5,160,304	11/1992	Van Der Hoeven	482/140
5,224,914	7/1993	Friedman	482/140

1 Claim, 6 Drawing Sheets

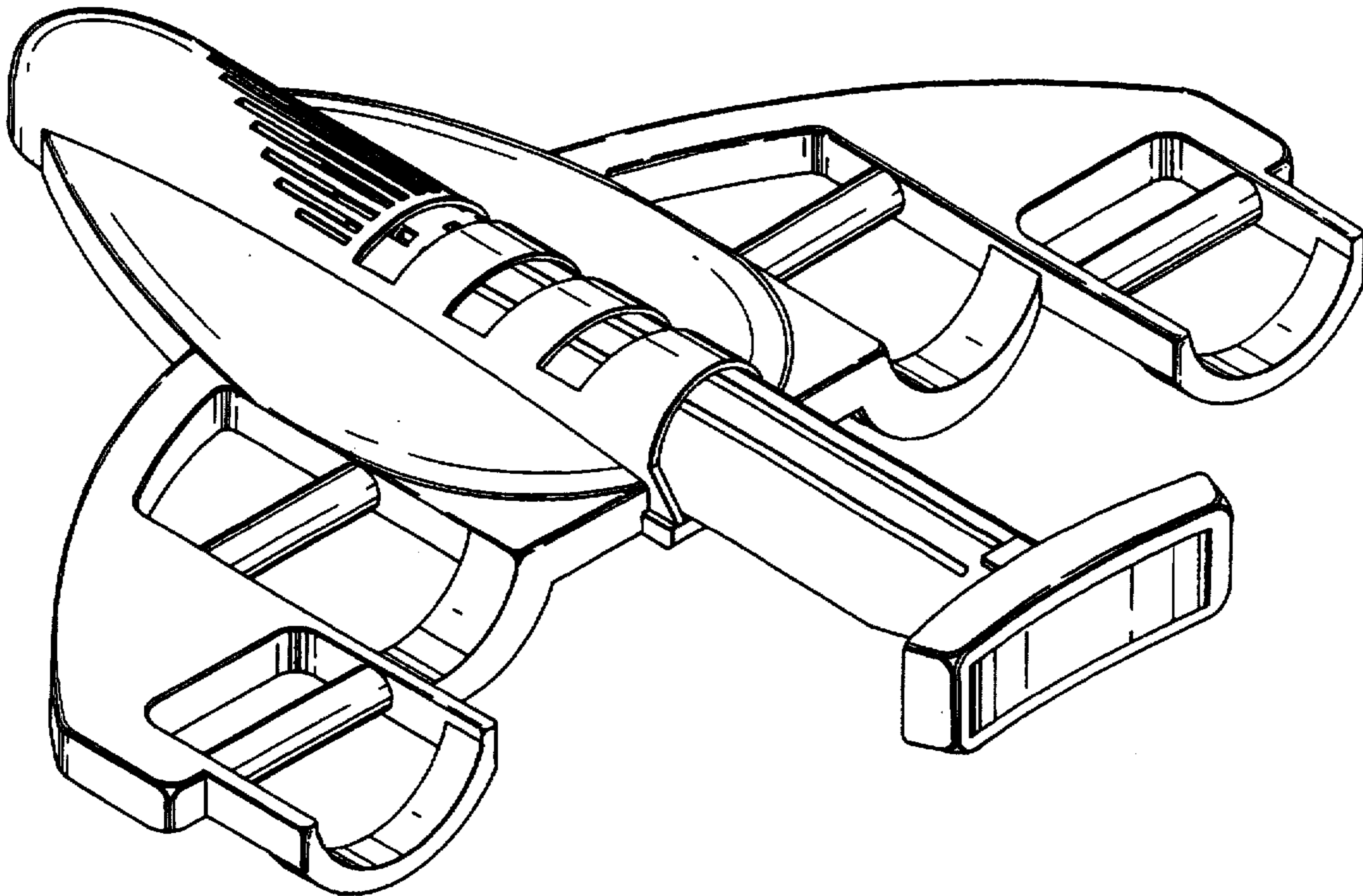

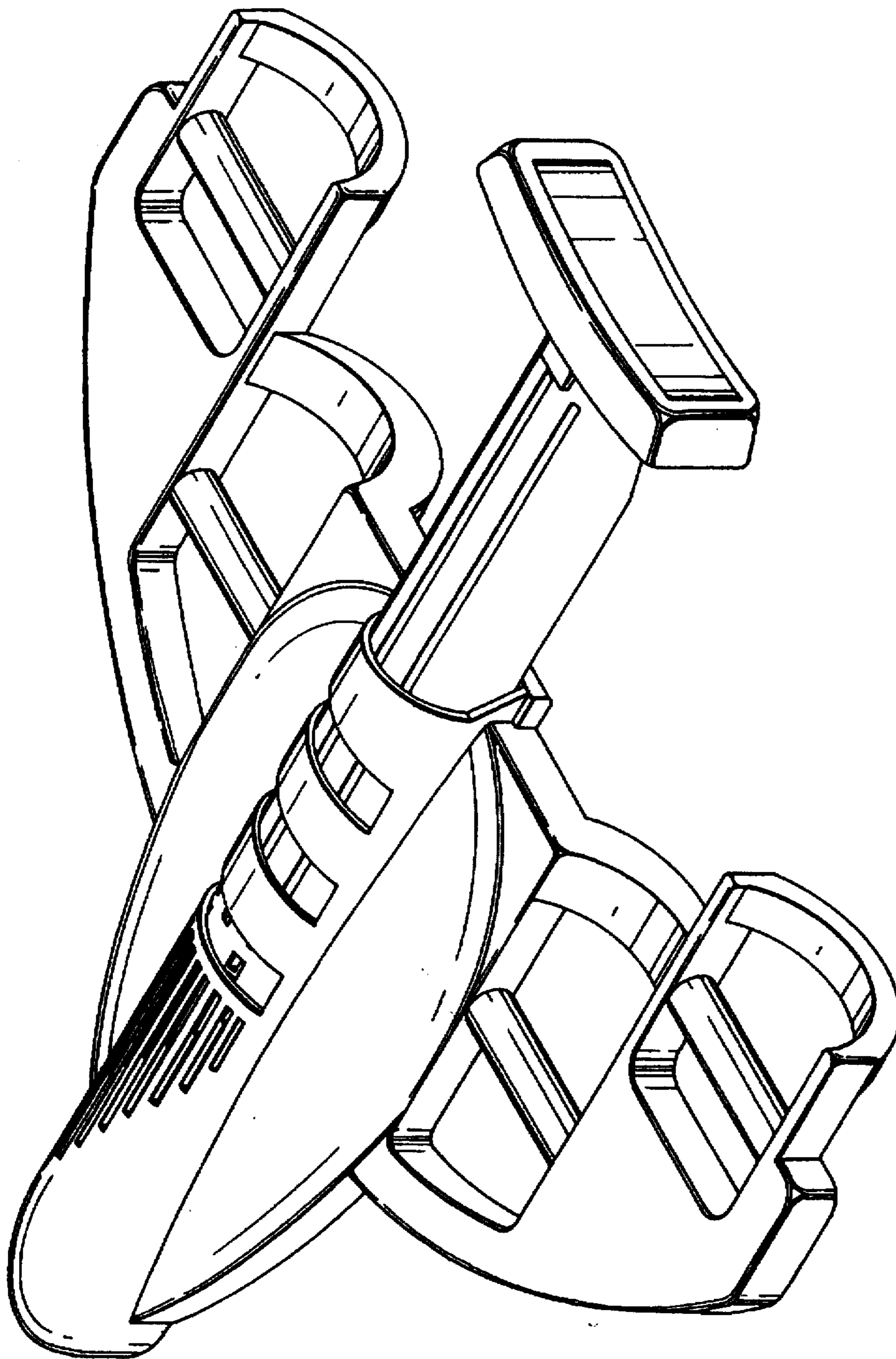

FIG. 1

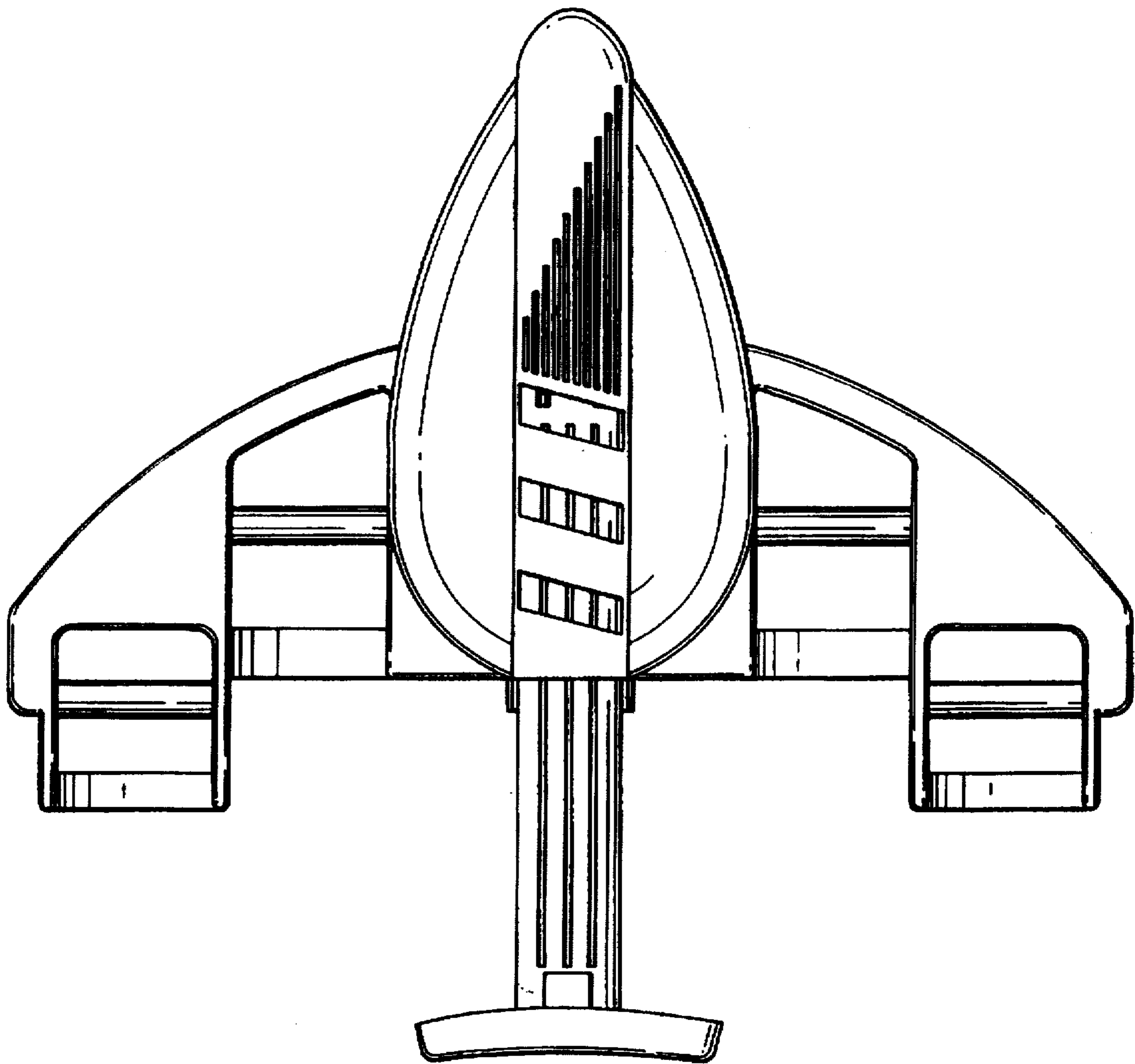

FIG. 2

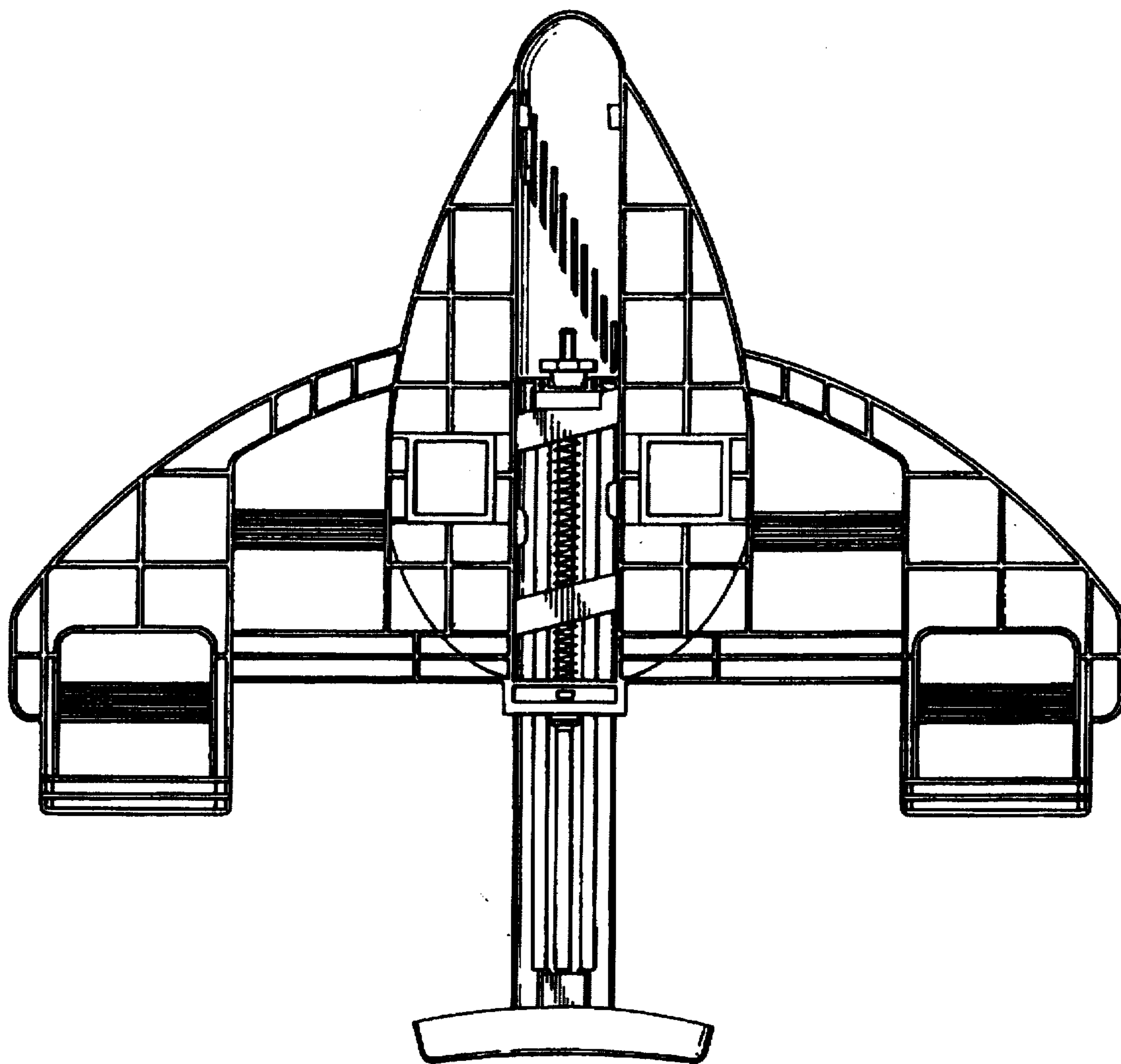

FIG. 3

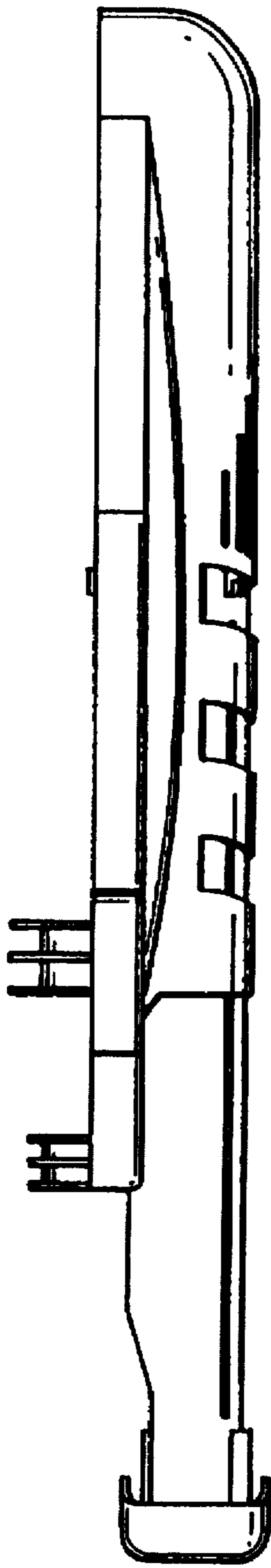

FIG. 4

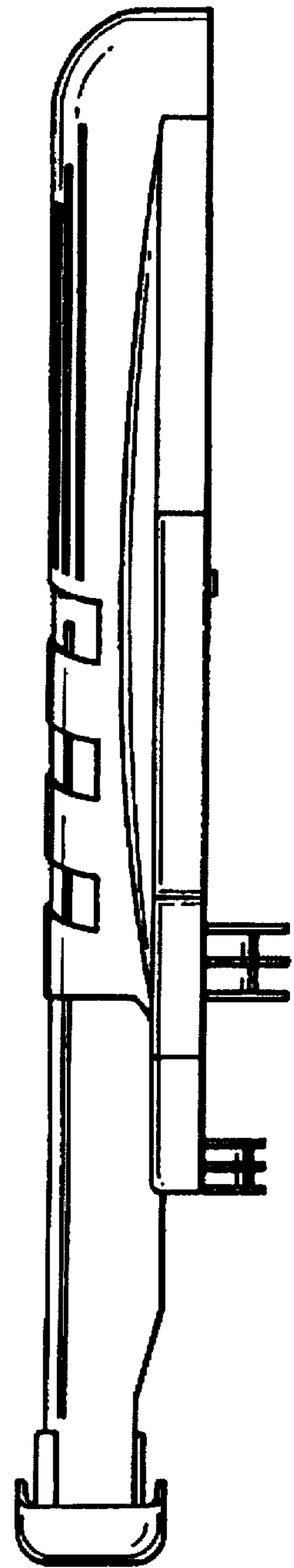

FIG. 5

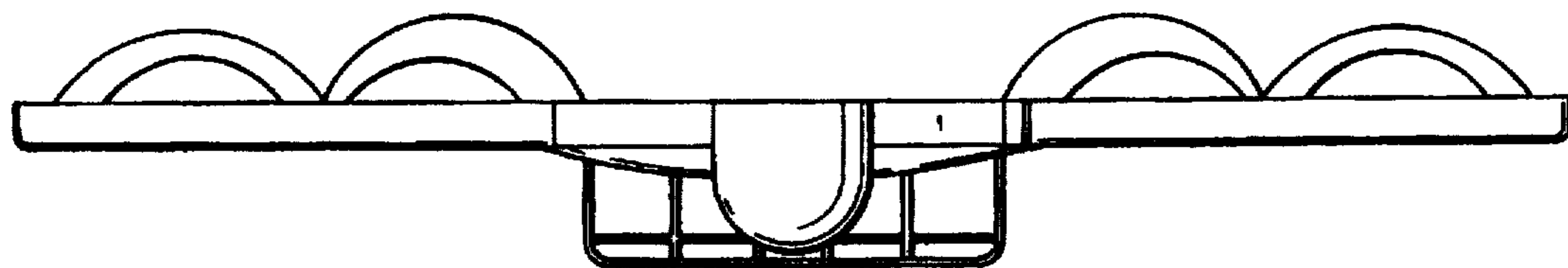

FIG. 6

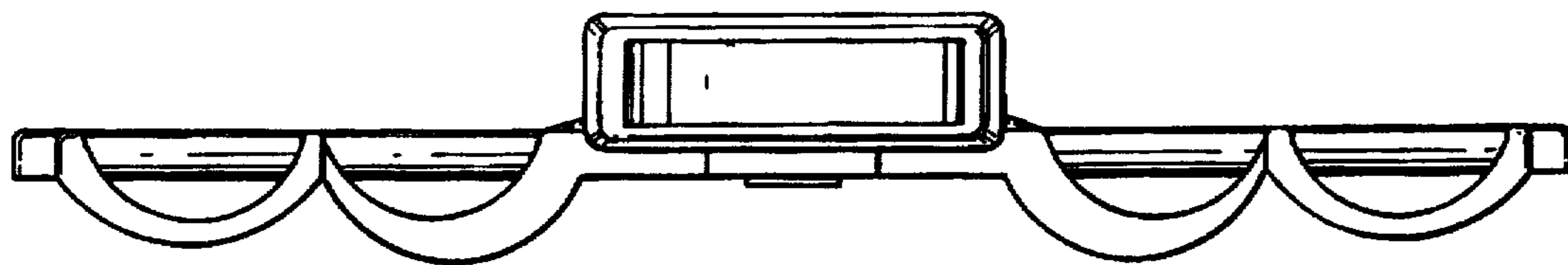

FIG. 7

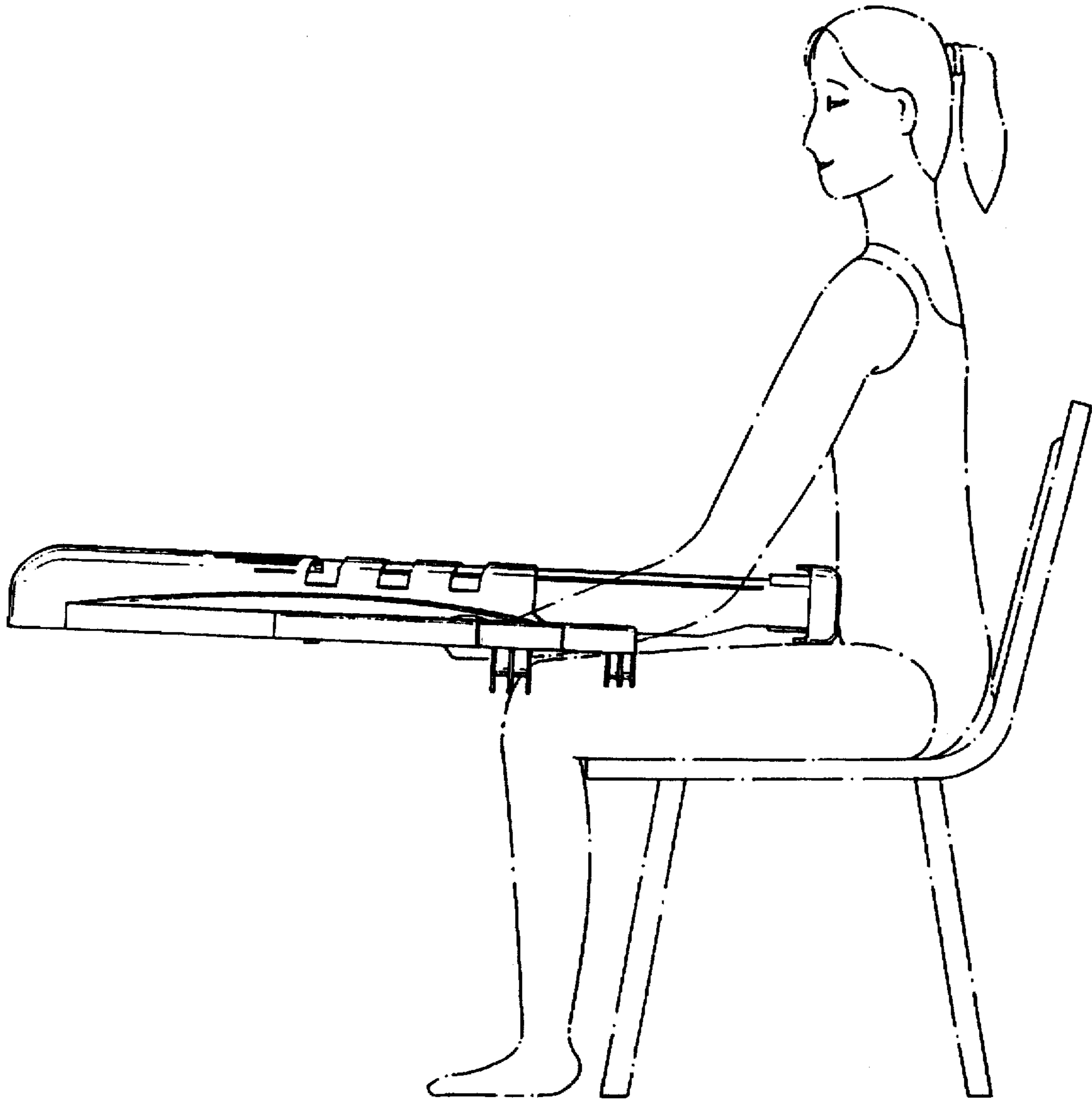

FIG. 8