



US00D386217S

United States Patent [19]
Okumura

[11] **Patent Number:** **Des. 386,217**
[45] **Date of Patent:** ****Nov. 11, 1997**

[54] **SIMULATION SHOOTING GAME MACHINE**
[75] **Inventor:** **Yutaka Okumura, Tokyo, Japan**
[73] **Assignee:** **Sega Enterprises, Ltd., Tokyo, Japan**
[**] **Term:** **14 Years**

2,845,270 7/1958 Durant 463/49
3,690,380 9/1972 Yokoi 463/51 X
4,123,059 10/1978 Guibas 273/356
4,215,867 8/1980 Natwick 273/357
5,439,230 8/1995 Mendes, Jr. 463/51 X

[21] **Appl. No.:** **58,562**
[22] **Filed:** **Aug. 19, 1996**

OTHER PUBLICATIONS

Vending Times, Mar. 1976, p. 52.
Vending Times, Dec. 1975, p. 62.

[30] **Foreign Application Priority Data**
Feb. 20, 1996 [JP] Japan 8-4245

Primary Examiner—Prabhakar G. Deshmukh
Attorney, Agent, or Firm—Michael N. Meller

[51] **LOC (6) Cl.** **21-01**
[52] **U.S. Cl.** **D21/13; D21/11**
[58] **Field of Search** **D21/1, 5, 11, 13,**
D21/147, 240; 463/1, 30, 31, 35, 46, 47,
51, 52; 273/355, 356, 357, 405

[57] **CLAIM**

The ornamental design for a simulation shooting game machine, as shown and described.

[56] **References Cited**

DESCRIPTION

FIG. 1 is a front view of a simulation shooting game machine showing my new design;
FIG. 2 is a rear view thereof;
FIG. 3 is a top view thereof;
FIG. 4 is a bottom view thereof;
FIG. 5 is a right side view thereof; and,
FIG. 6 is a left side view thereof.

U.S. PATENT DOCUMENTS

D. 242,566 11/1976 Green D21/13
D. 253,001 9/1979 Huang D21/13
D. 330,050 10/1992 Sato et al. D21/240 X
2,520,281 8/1950 Heide 463/49 X

1 Claim, 4 Drawing Sheets

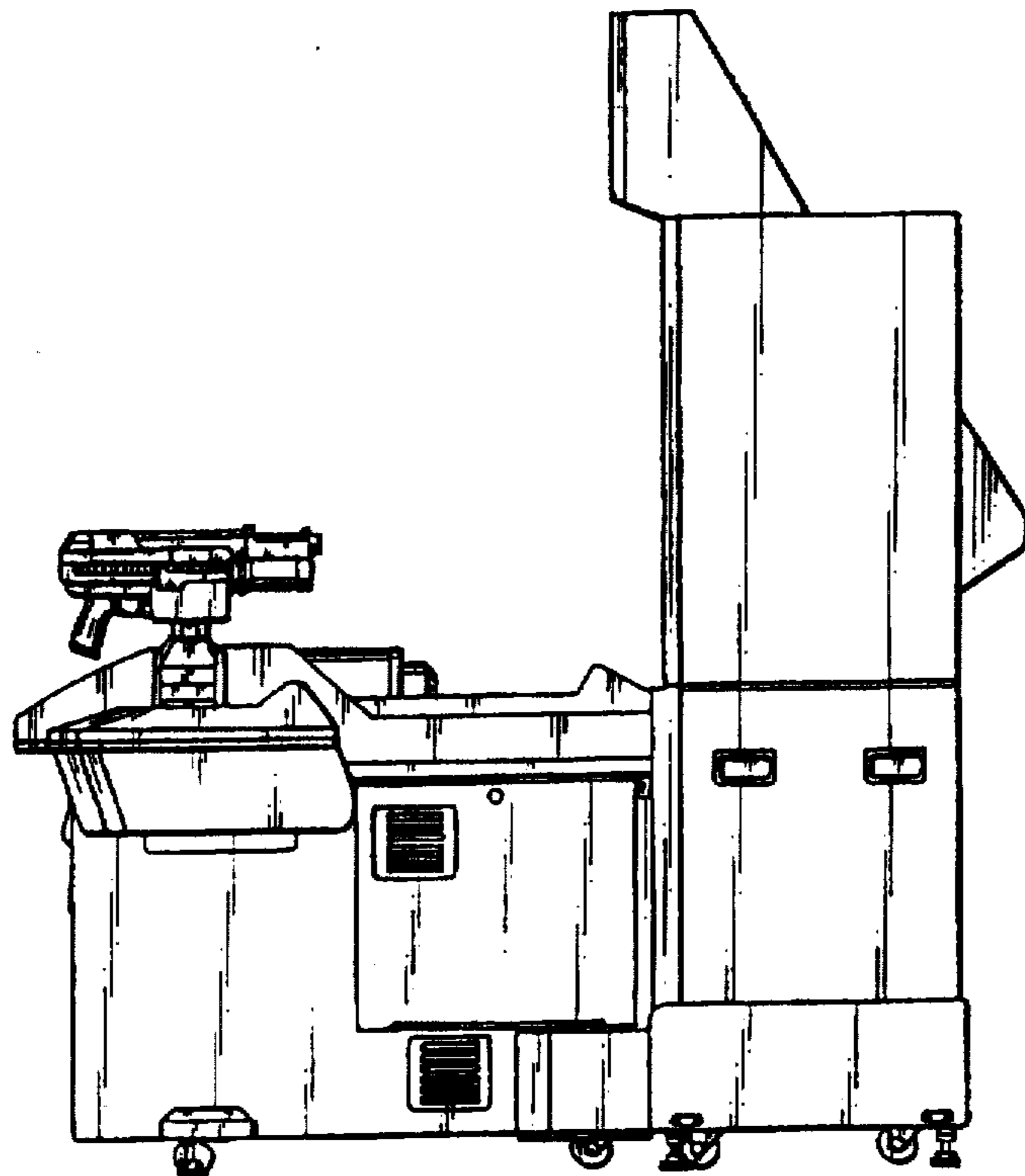
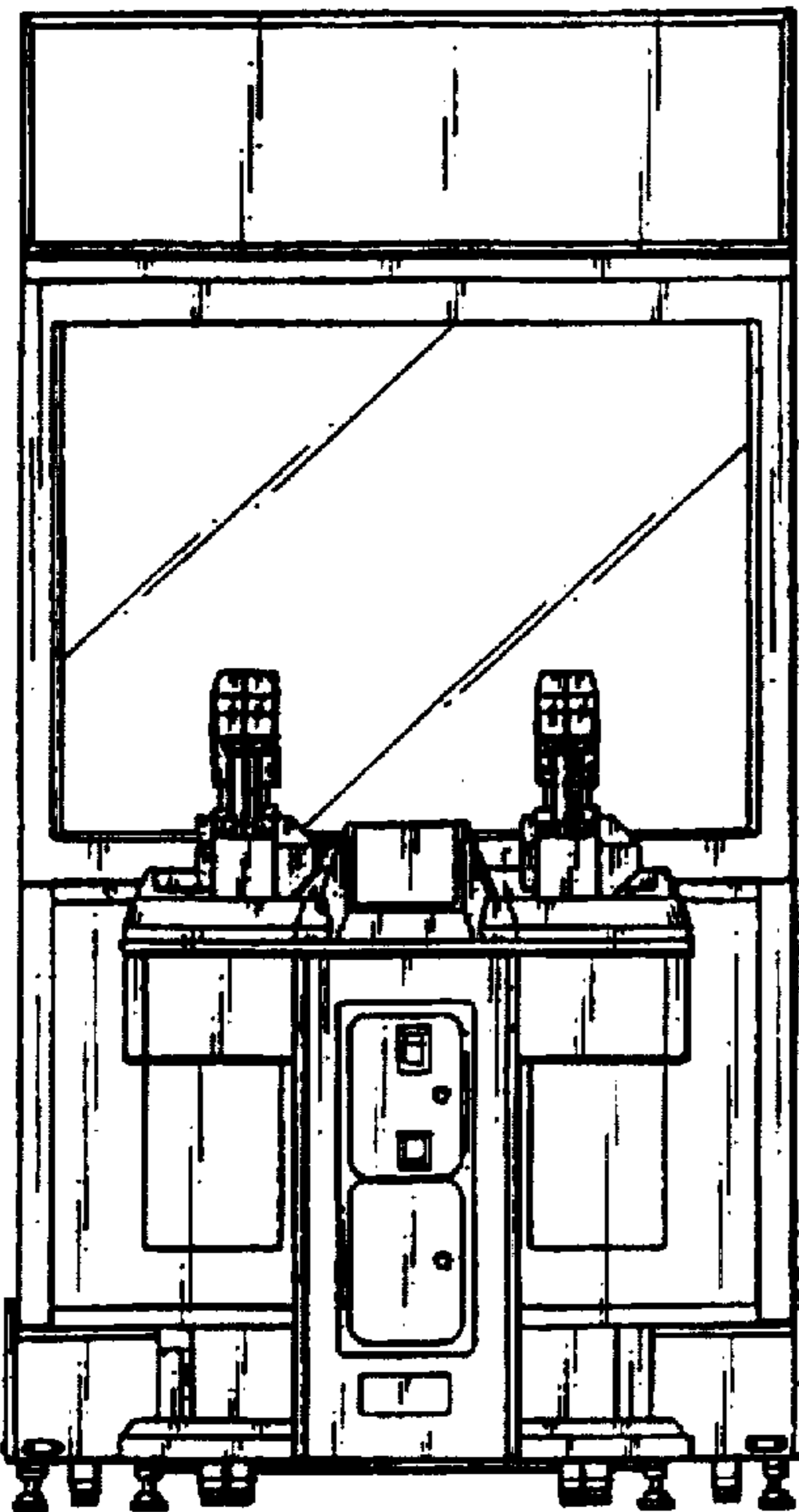

FIG.1

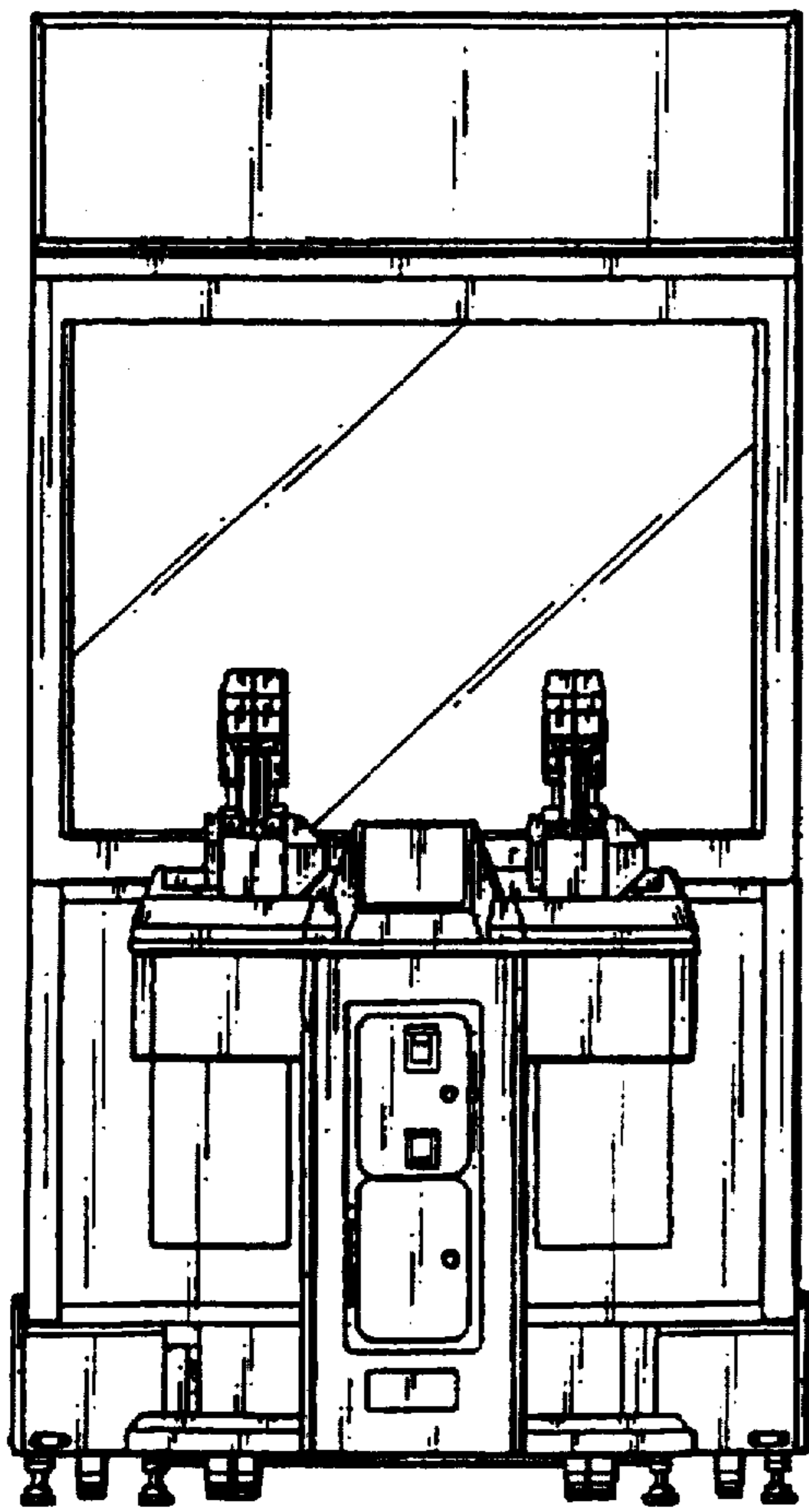

FIG. 2

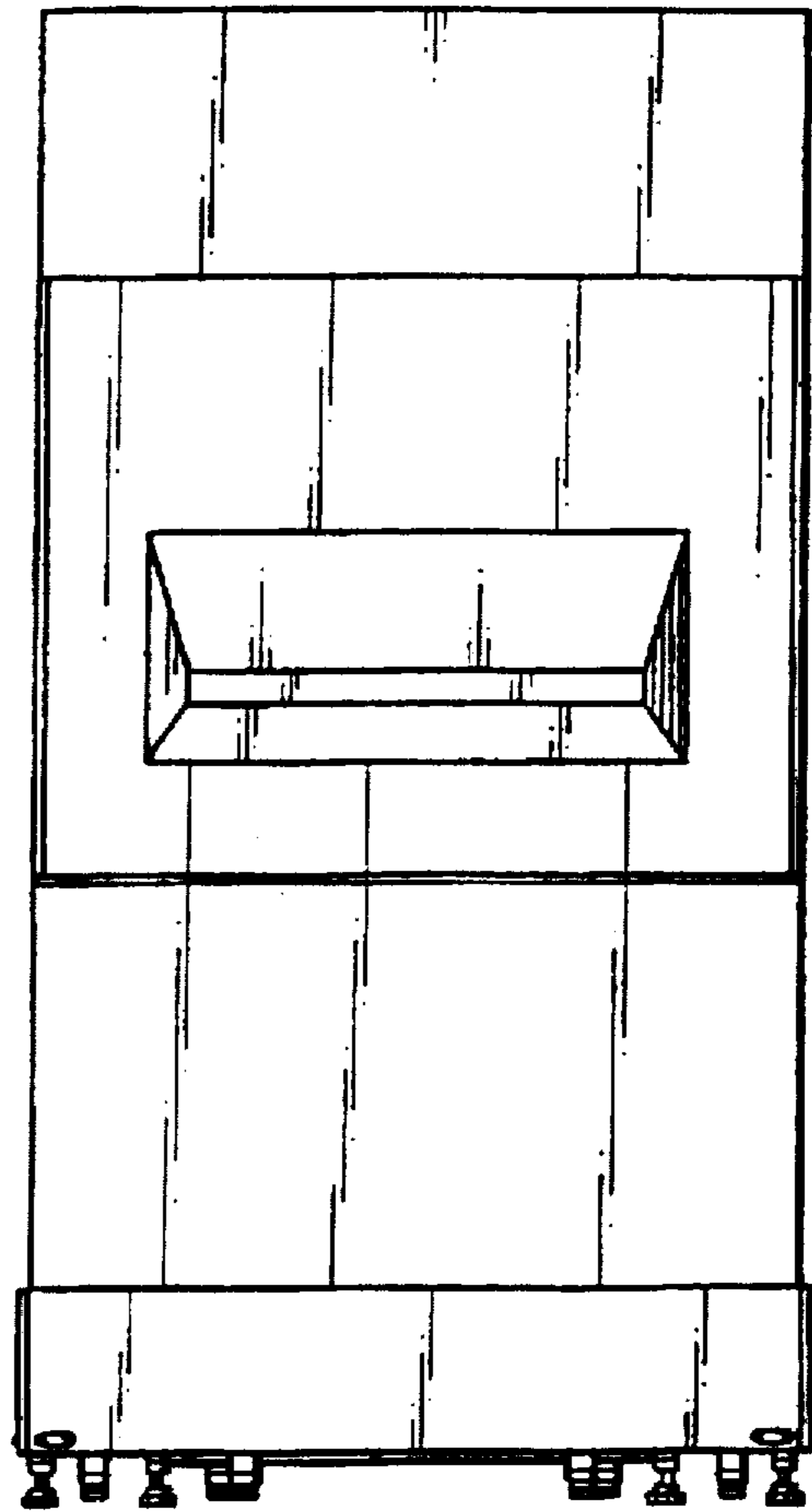

FIG. 3

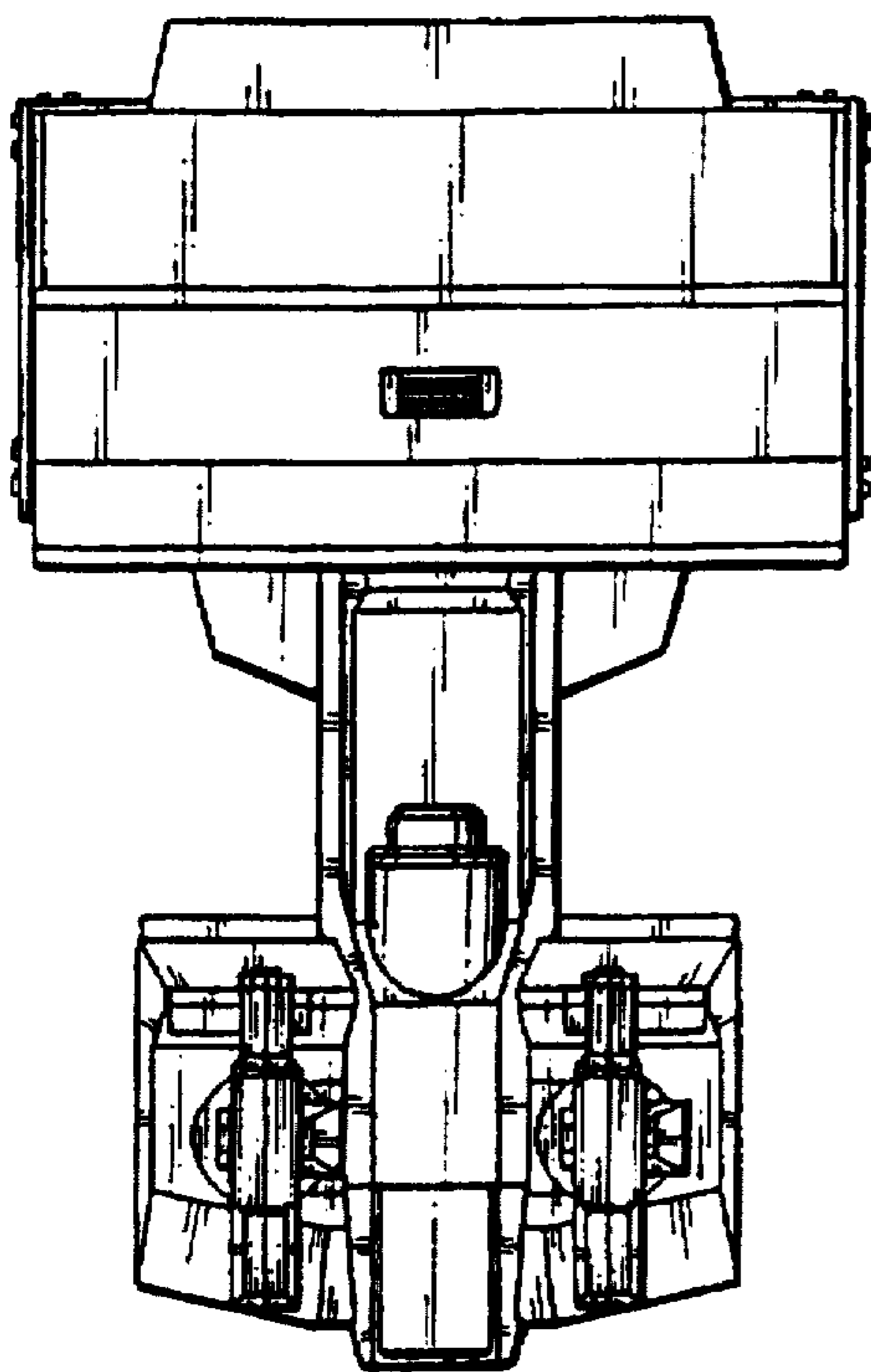

FIG. 4

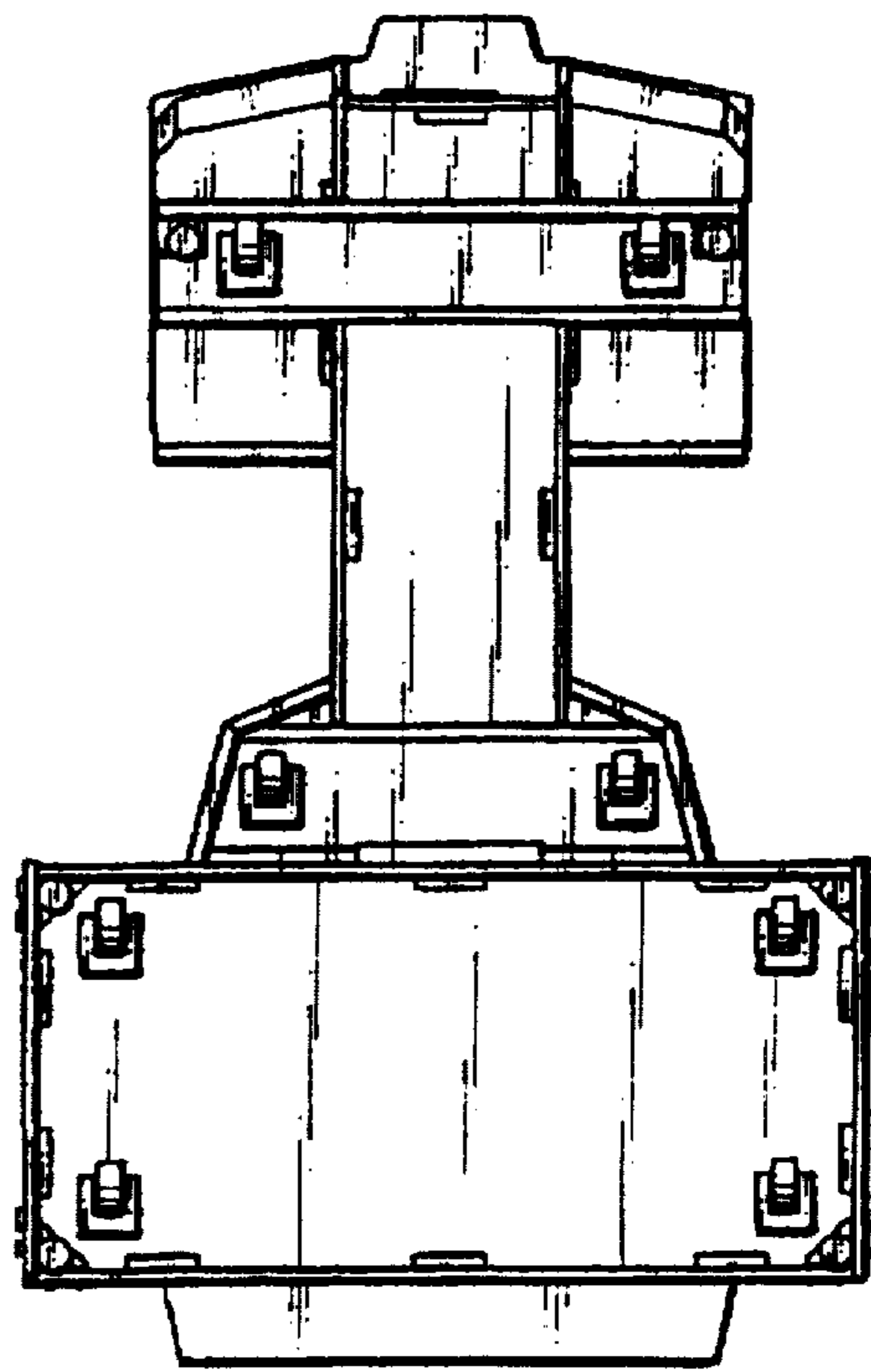

FIG. 5

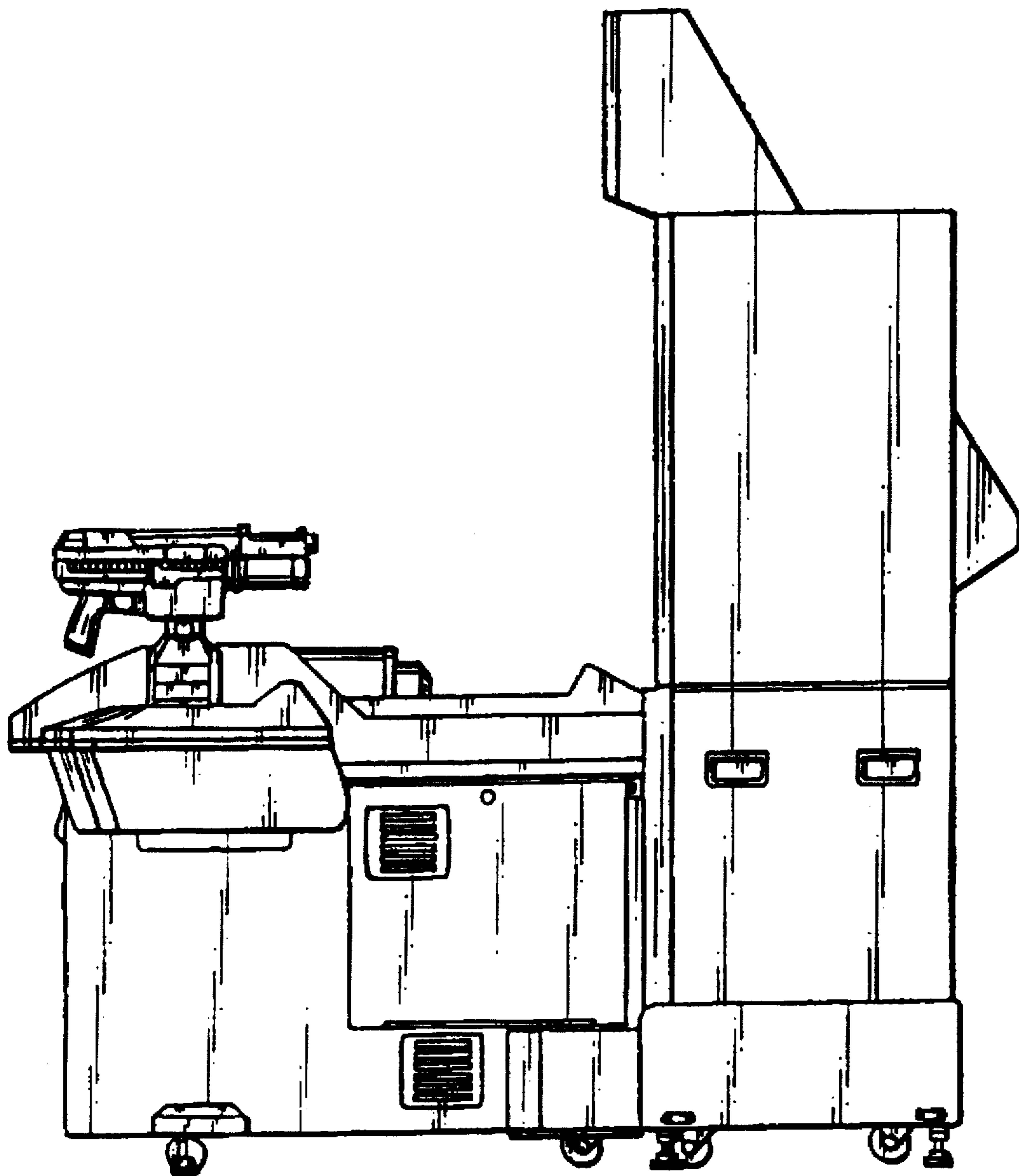

FIG. 6

