



US00D386172S

# United States Patent [19]

[11] Patent Number: Des. 386,172

Kawauchi et al.

[45] Date of Patent: \*\*Nov. 11, 1997

## [54] ADJUSTABLE COMPUTER KEYBOARD

[75] Inventors: **Masahiko Kawauchi**, San Jose; **Shigetoshi Amano**, Sunnyvale; **J. Scott Petermann**, San Jose; **Thomas Overthun**, San Francisco, all of Calif.

[73] Assignee: **Alps Electric (U.S.A.), Inc.**, San Jose, Calif.

[\*\*] Term: **14 Years**

[21] Appl. No.: **58,079**

[22] Filed: **Aug. 7, 1996**

[51] LOC (6) Cl. .... **14-02**

[52] U.S. Cl. .... **D14/115**

[58] Field of Search ..... D14/100, 101, D14/106, 115; D18/1, 2, 7; 235/145 A, 145 R; 200/5 A, 5 R, 6 A, 6 R; 345/168, 160; 341/22, 23; 364/708.1; 400/472, 479, 484-486

## [56] References Cited

### U.S. PATENT DOCUMENTS

D. 338,000	8/1993	Aurigema	.....	D14/115
D. 362,235	9/1995	Franzen	.....	D14/100
D. 362,434	9/1995	Abell, Jr. et al.	.....	D14/115
D. 370,476	6/1996	Dalesky	.....	D14/115

Primary Examiner—Freda Nunn

Attorney, Agent, or Firm—Guy W. Shoup; Patrick T. Bever

## [57] CLAIM

The ornamental design for an adjustable computer keyboard, as shown and described.

## DESCRIPTION

FIG. 1 is a top front and side perspective view of an adjustable computer keyboard showing our new design; FIG. 2 is a top front and side perspective view thereof showing a second arrangement wherein a bifurcated QWERTY keyboard portion is spaced apart from a numerical keypad portion; FIG. 3 is a front view of the bifurcated QWERTY keyboard portion thereof shown separately for clarity of illustration only; FIG. 4 is a right side view thereof; FIG. 5 is a rear view thereof; FIG. 6 is a left side view thereof; FIG. 7 is a top plan view thereof; FIG. 8 is a bottom plan view thereof; FIG. 9 is a front view of the numerical keypad portion thereof shown separately for clarity of illustration only; FIG. 10 is a right side view thereof; FIG. 11 is a rear view thereof; FIG. 12 is a left side view thereof; FIG. 13 is a top plan view thereof; and, FIG. 14 is a bottom plan view thereof.

The broken lines are shown in the views for illustrative purposes only and form no part of the claimed design and the cord is shown broken away to show an indeterminate length.

1 Claim, 7 Drawing Sheets

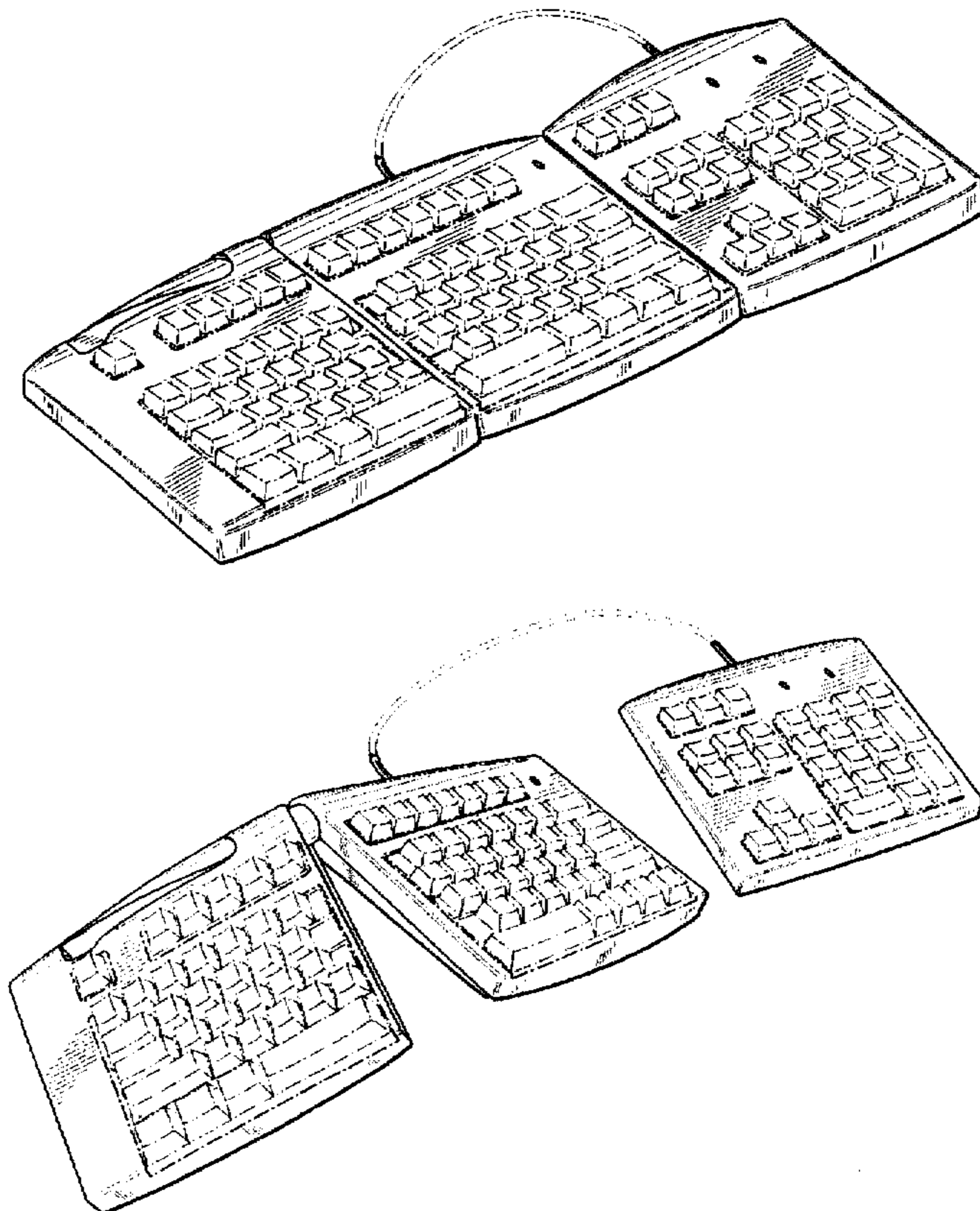

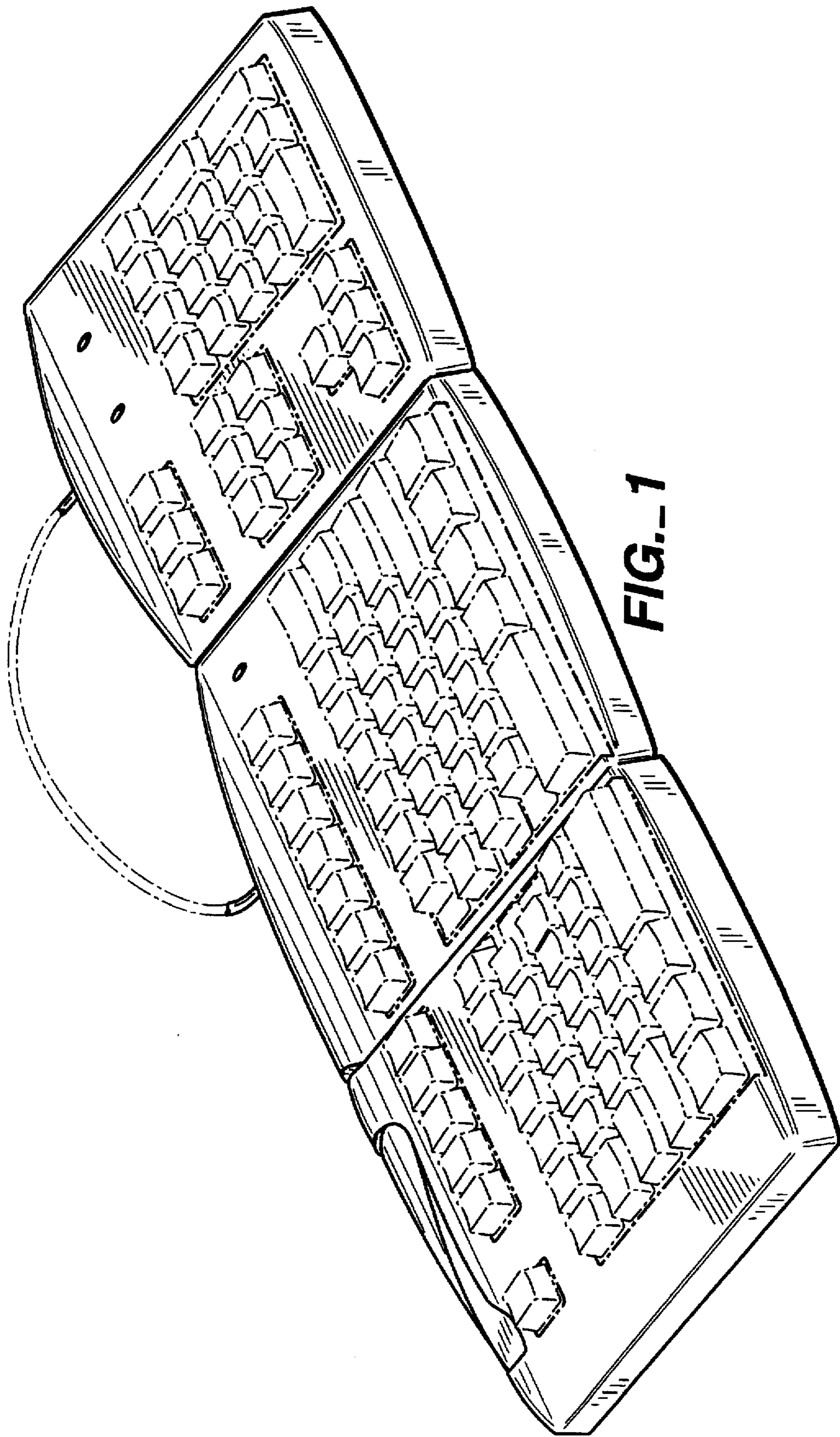

FIG. 1

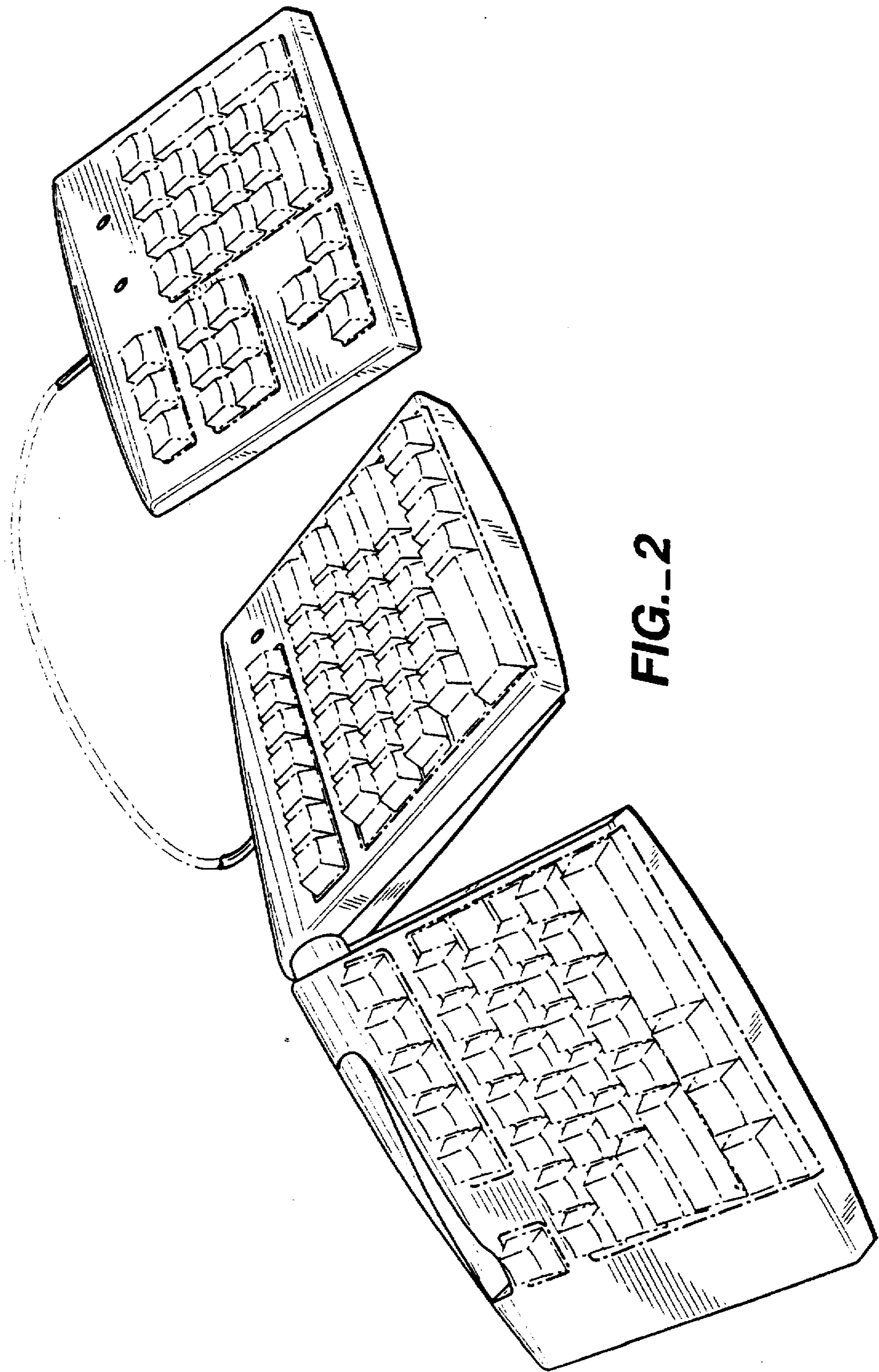

FIG.-2

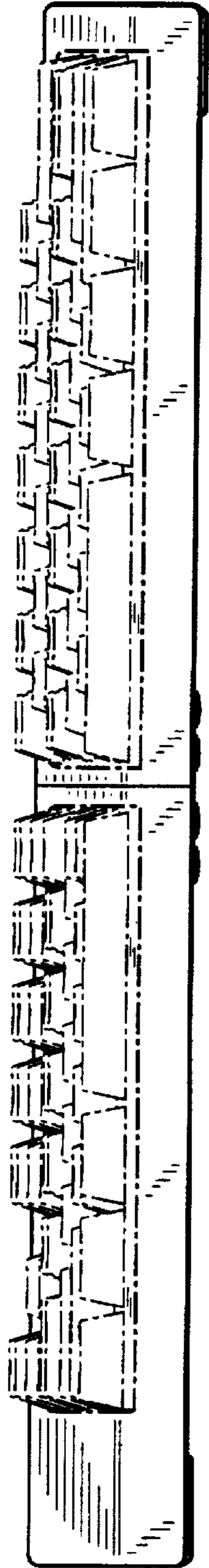

FIG. 3

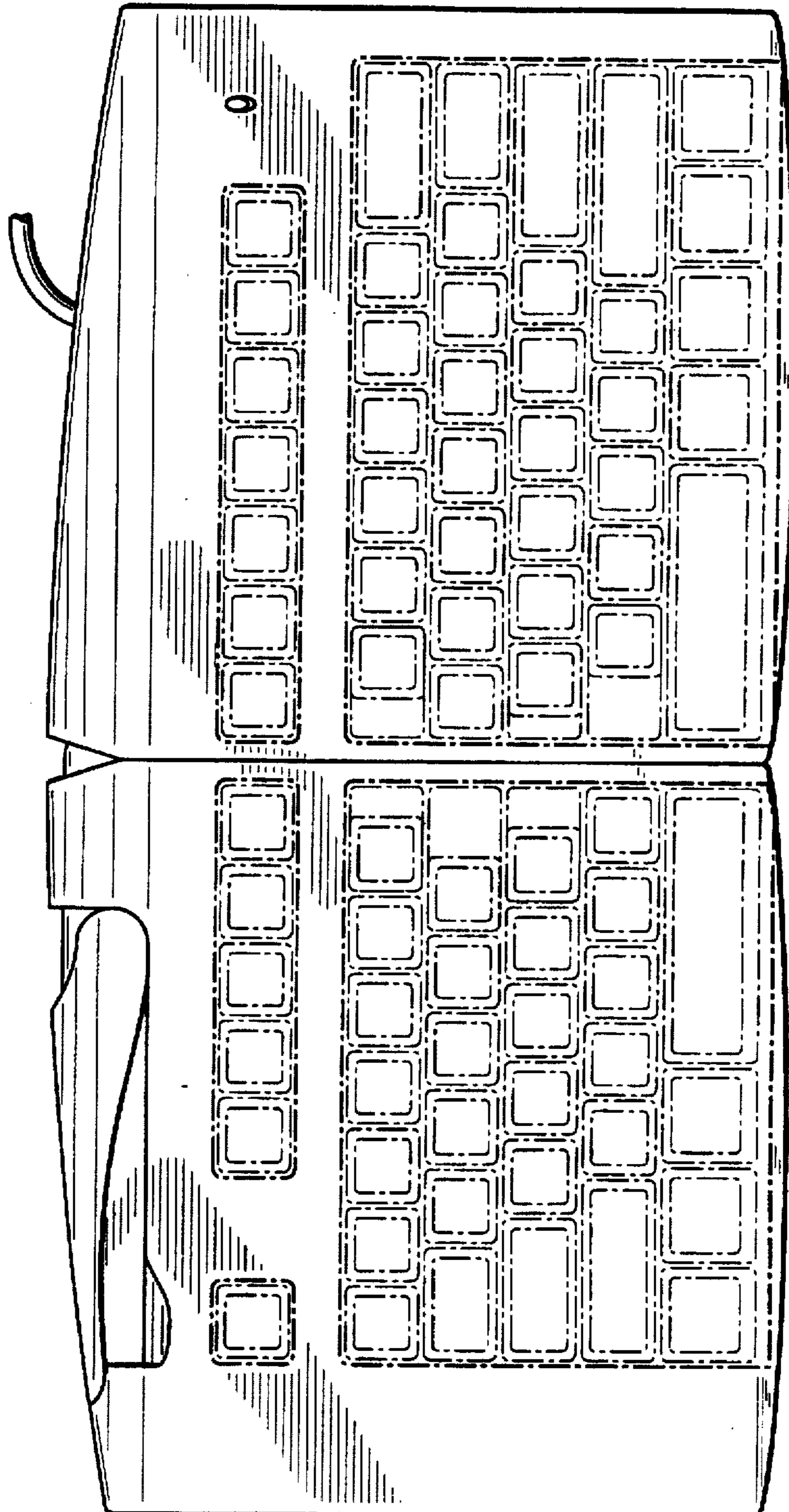
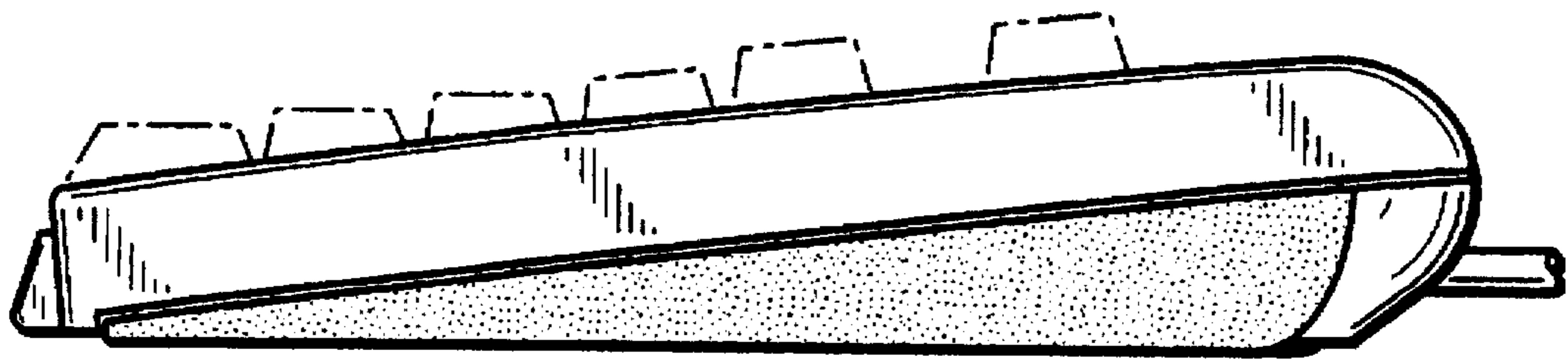
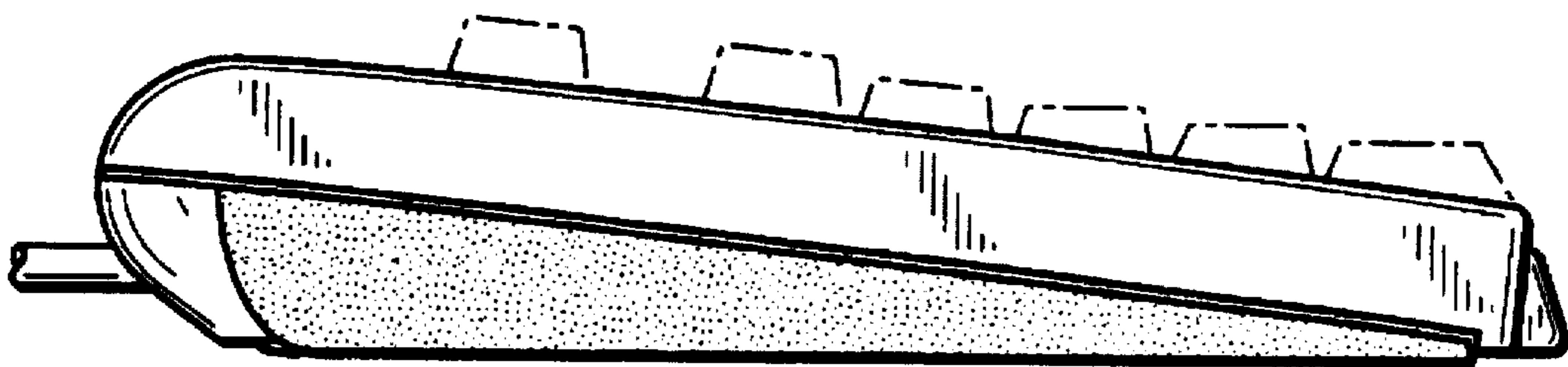

FIG. 7



**FIG.\_4**



**FIG.\_6**

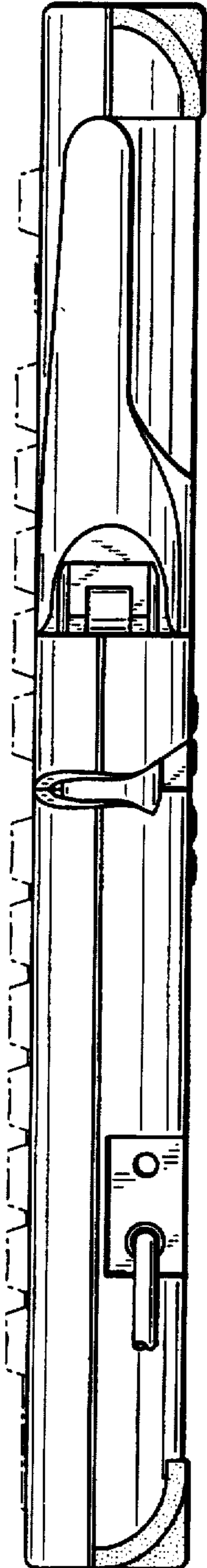

**FIG. 5**

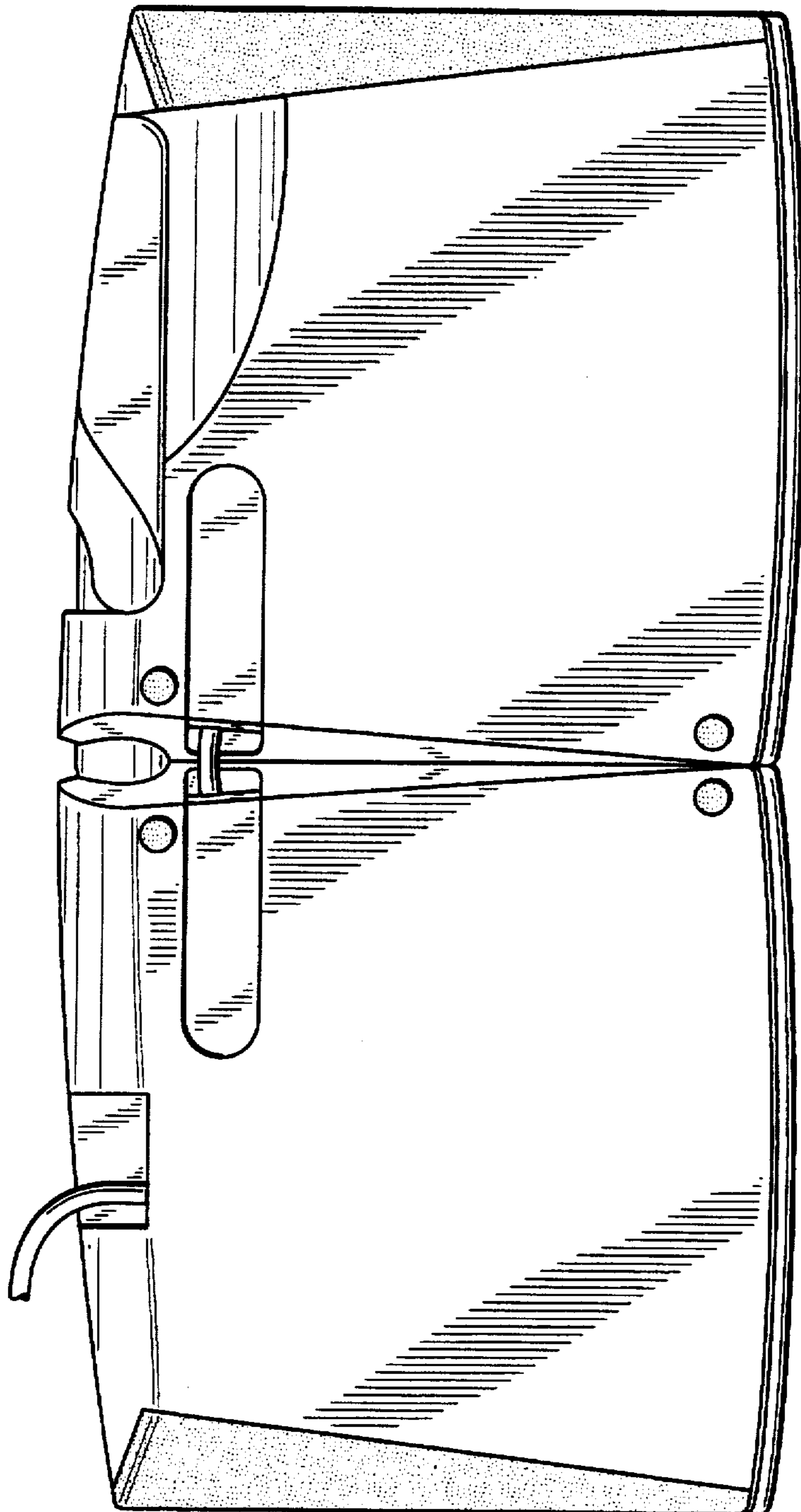

**FIG. 8**

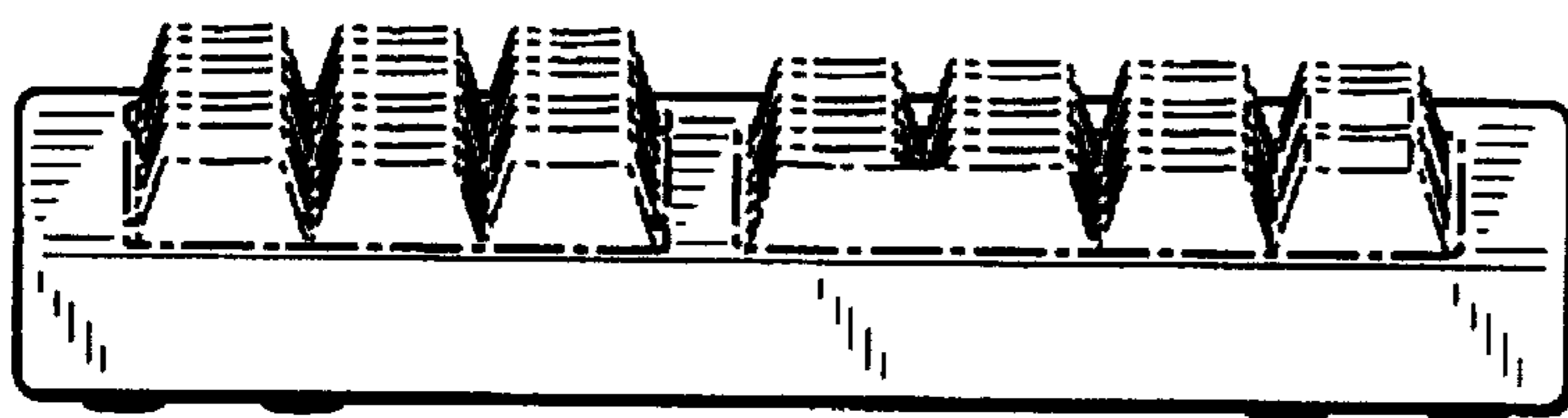

**FIG. 9**

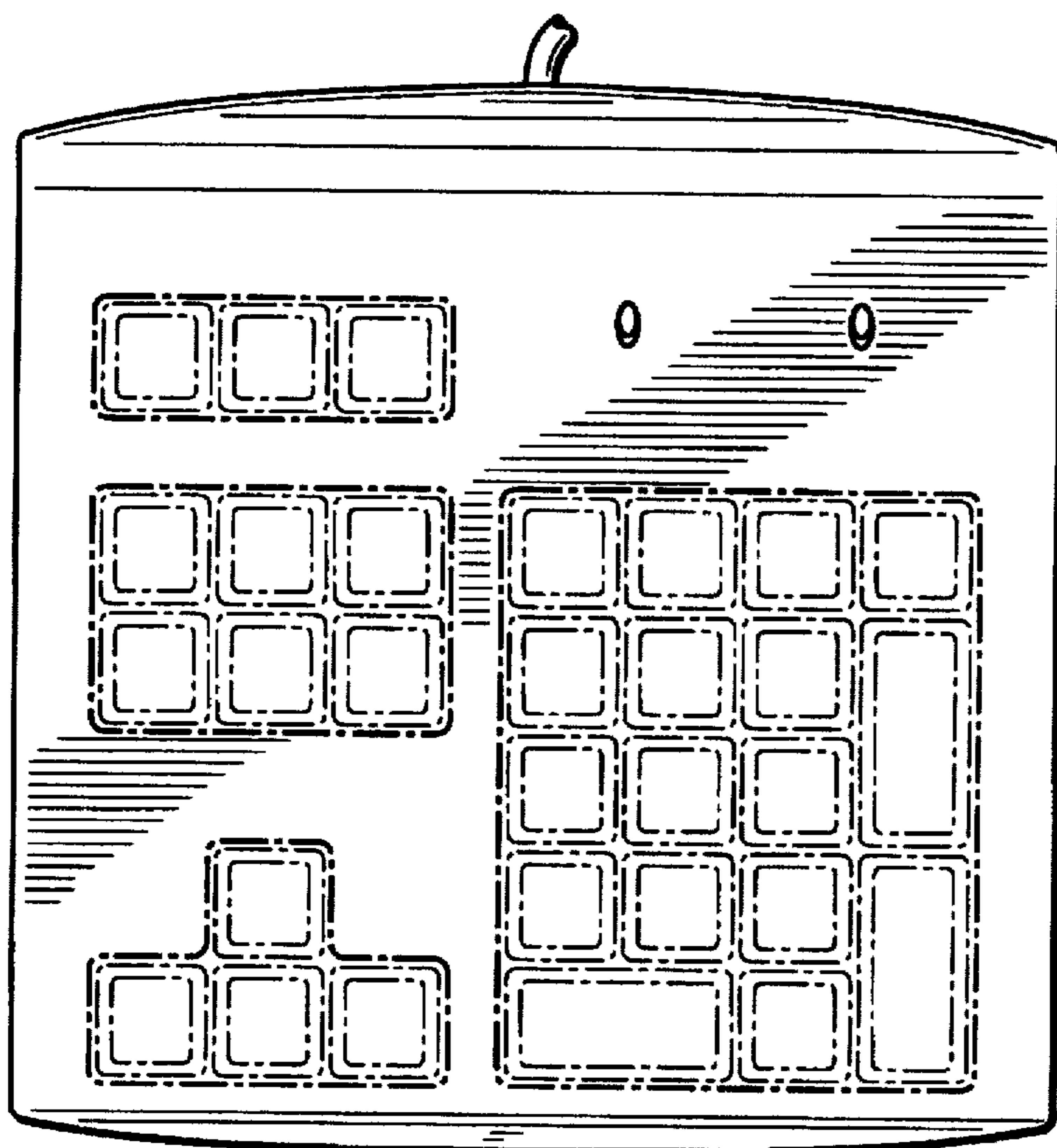

**FIG. 13**

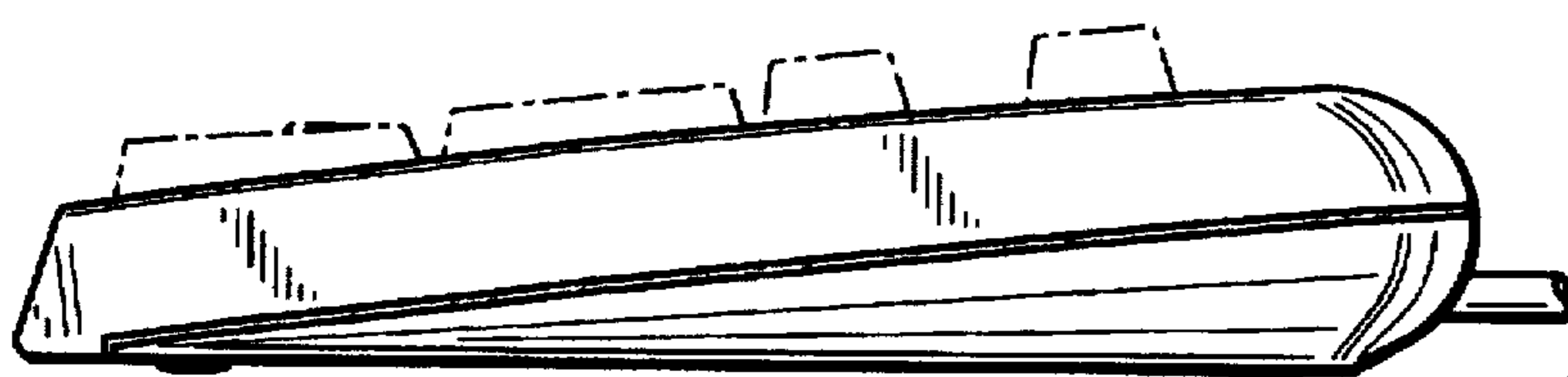

**FIG. 10**

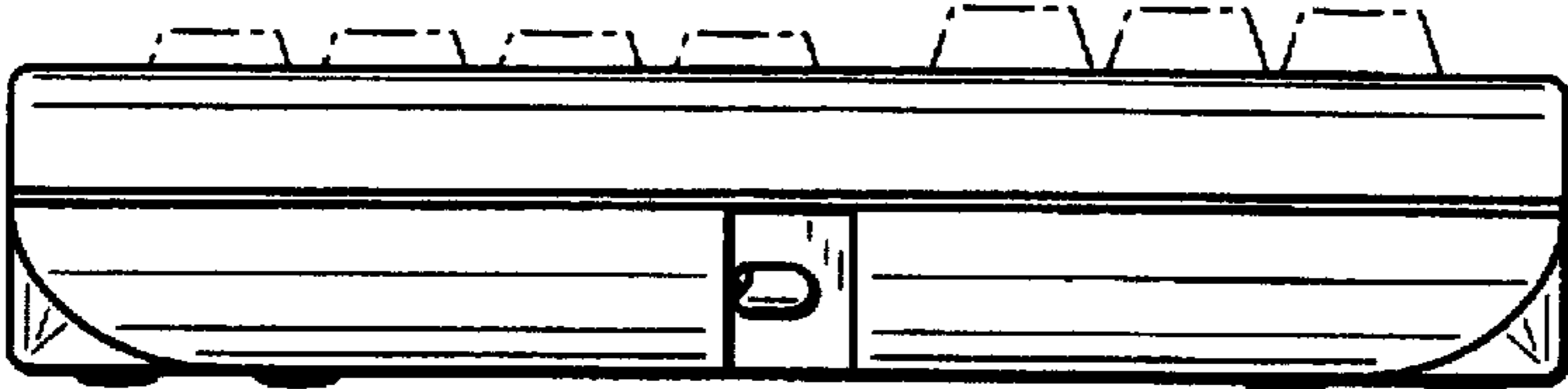

**FIG.\_11**

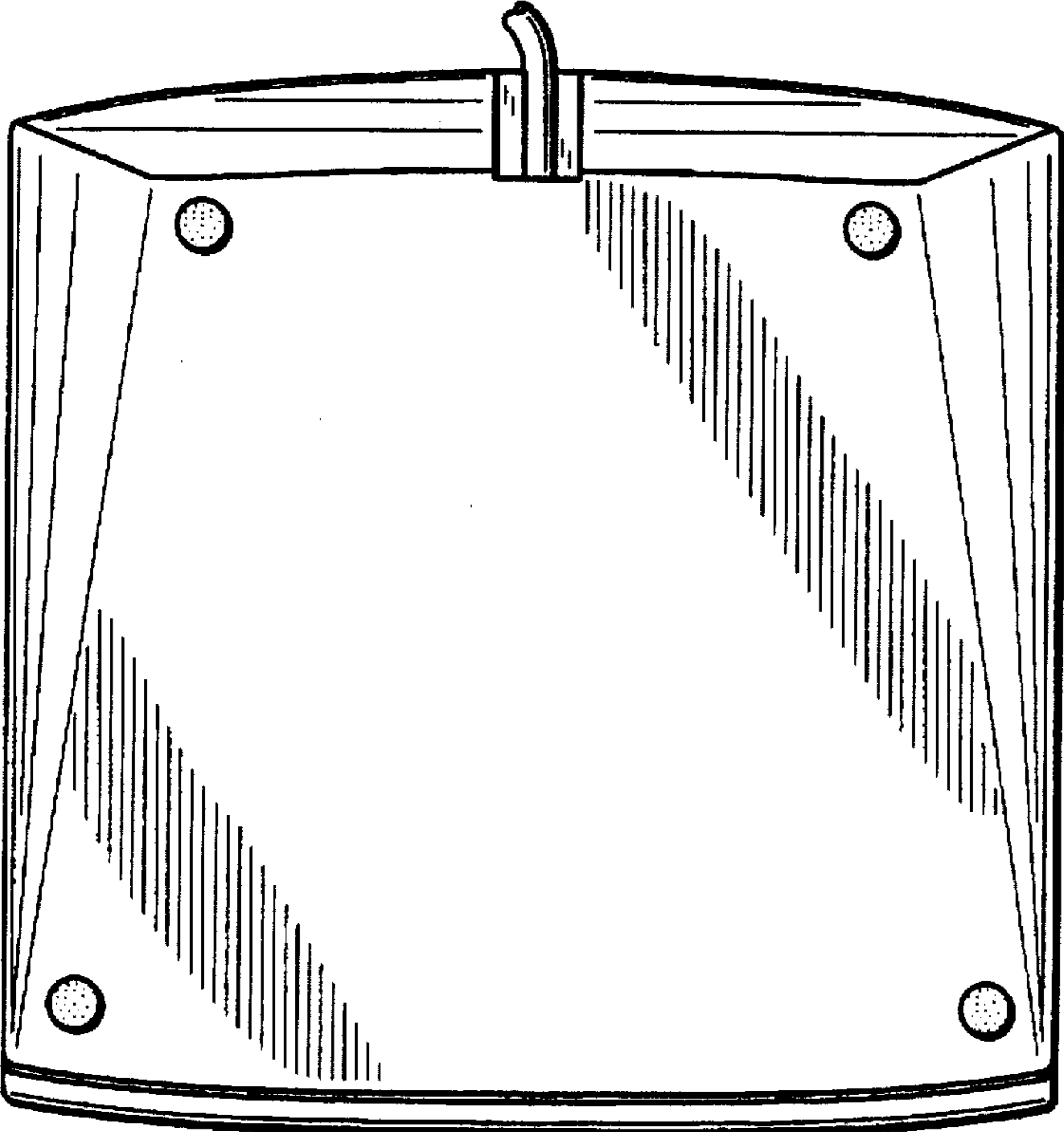

**FIG.\_14**

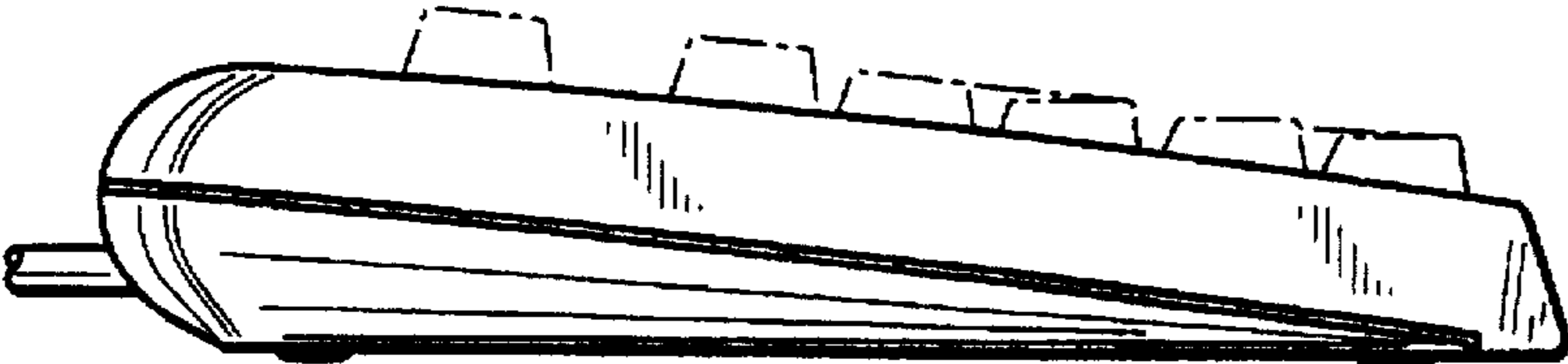

**FIG.\_12**