



US00D386153S

United States Patent [19]
Crump et al.

[11] **Patent Number: Des. 386,153**
[45] **Date of Patent: **Nov. 11, 1997**

[54] **PERSONAL COMPUTER MEDIA CONSOLE**

[75] **Inventors: Dwayne Thomas Crump, Apex;**
Robert Edward Steinbugler, Raleigh;
John David Swansey, Durham, all of
N.C.

[73] **Assignee: International Business Machines**
Corporation, Armonk, N.Y.

[**] **Term: 14 Years**

[21] **Appl. No.: 57,628**

[22] **Filed: Jul. 29, 1996**

[51] **LOC (6) Cl. 14-02**

[52] **U.S. Cl. D14/100; D14/109**

[58] **Field of Search D14/100, 102,**
D14/107-109; D6/432, 436, 445, 448; D13/162,
184, 199; 312/208.1, 254, 292; 360/99.12;
361/690-696, 683

[56] **References Cited**

U.S. PATENT DOCUMENTS

| | | | |
|------------|--------|----------------------|---------|
| D. 296,554 | 7/1988 | Shiozawa et al. | D14/109 |
| D. 358,140 | 5/1995 | Takasu et al. | D14/109 |
| D. 371,545 | 7/1996 | Ojeda | D14/107 |

Primary Examiner—Freda Nunn
Attorney, Agent, or Firm—Anthony N. Magistrale

[57] **CLAIM**

The ornamental design for a personal computer media console, as shown and described.

DESCRIPTION

FIG. 1 is a right, front, and top perspective view of the personal computer media console, showing our new design; FIG. 2 is a front elevational view thereof; FIG. 3 is a rear elevational view thereof; FIG. 4 is a top plan view thereof; FIG. 5 is a right side elevational view thereof; FIG. 6 is a left side elevational view thereof; FIG. 7 is a right, front, and top perspective view of the personal computer media console with the drive housing in the open position; FIG. 8 is a front elevational view of the personal computer media console of FIG. 7; FIG. 9 is a rear elevational view of the personal computer media console of FIG. 7; FIG. 10 is a right side elevational view of the personal computer media console of FIG. 7; FIG. 11 is a left side elevational view of the personal computer media console of FIG. 7; FIG. 12 is a top plan view of the personal computer media console of FIG. 7; and, FIG. 13 is bottom plan view of the personal computer media console.

1 Claim, 10 Drawing Sheets

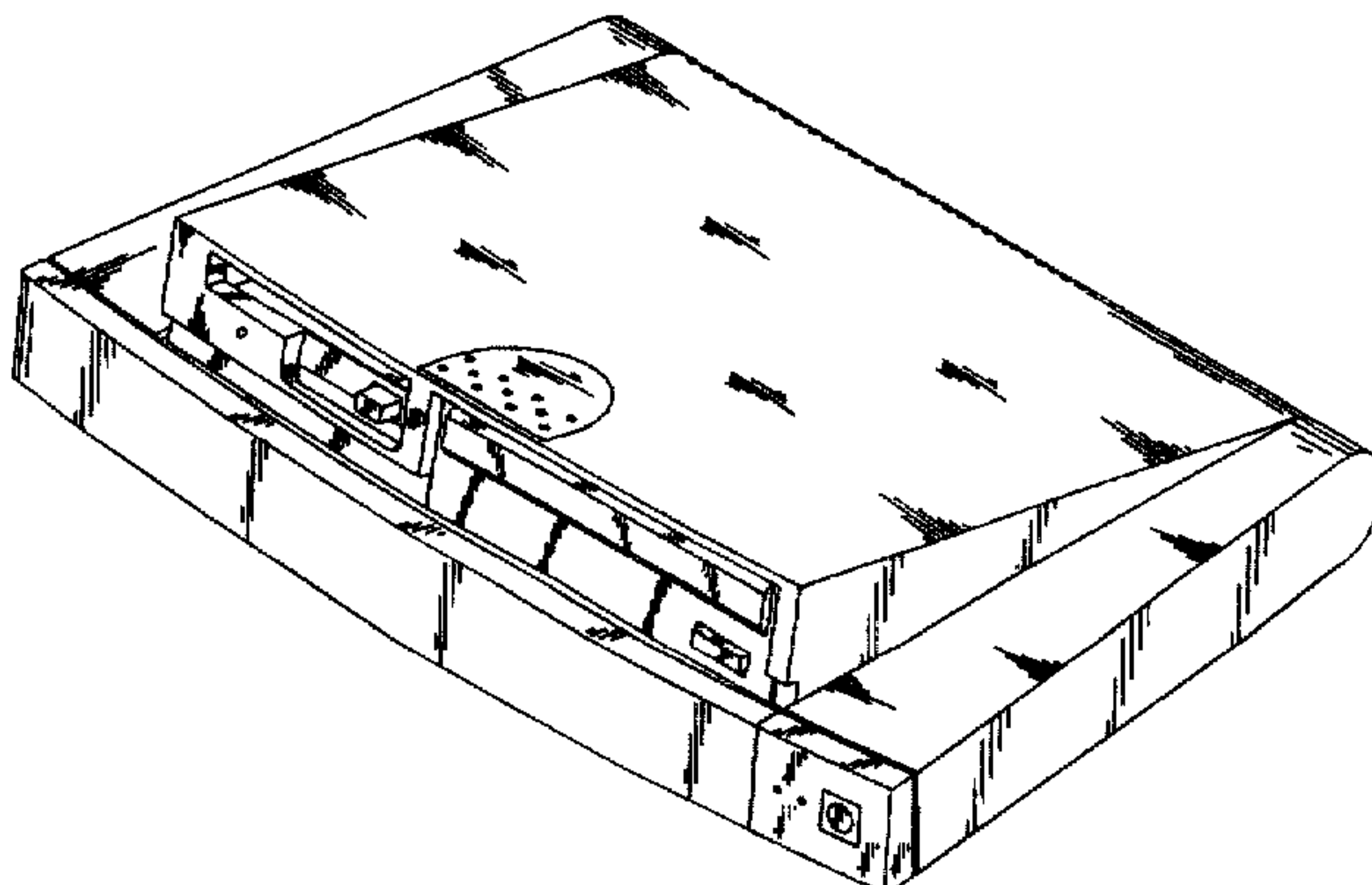
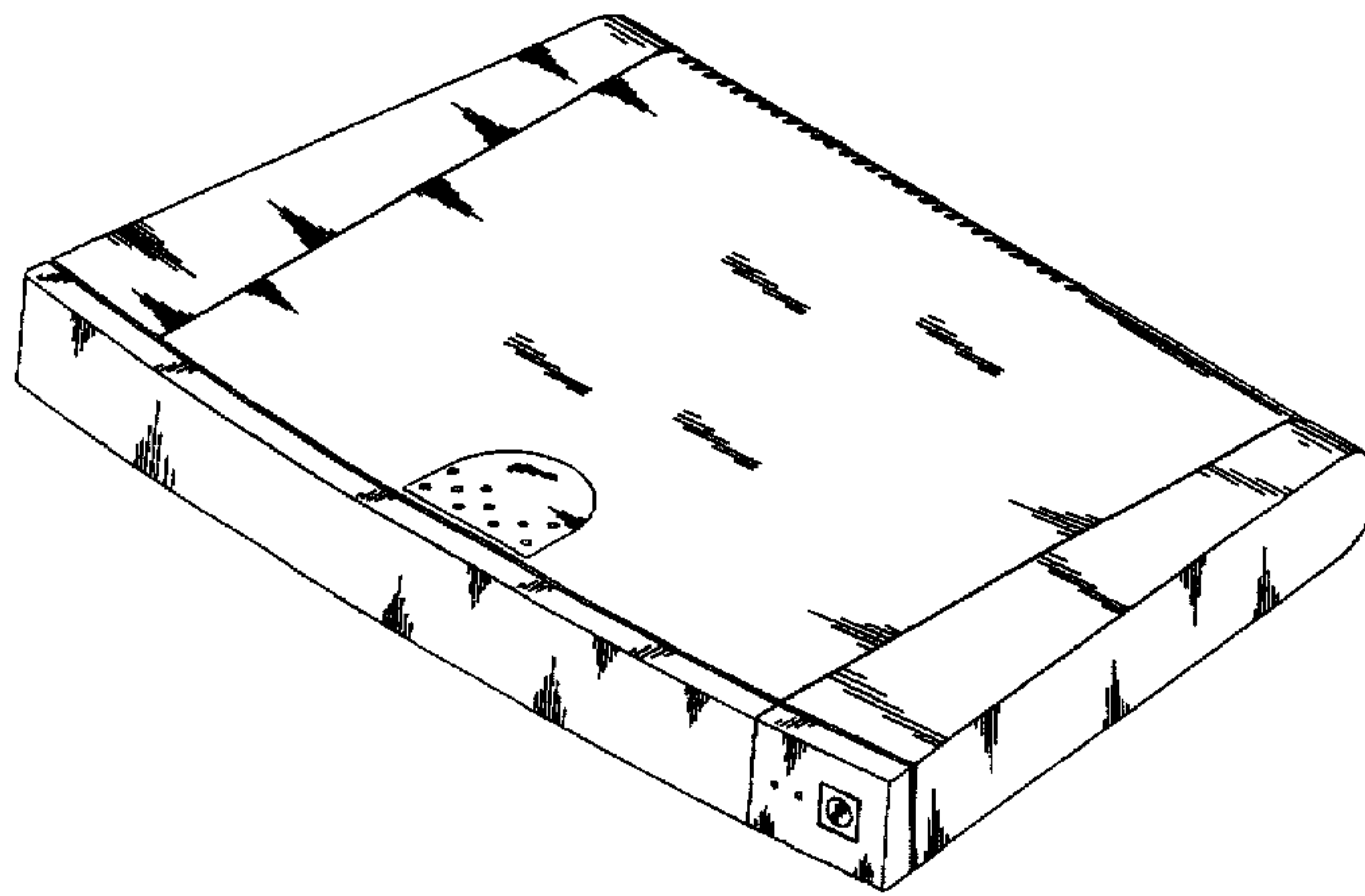

FIG. 1

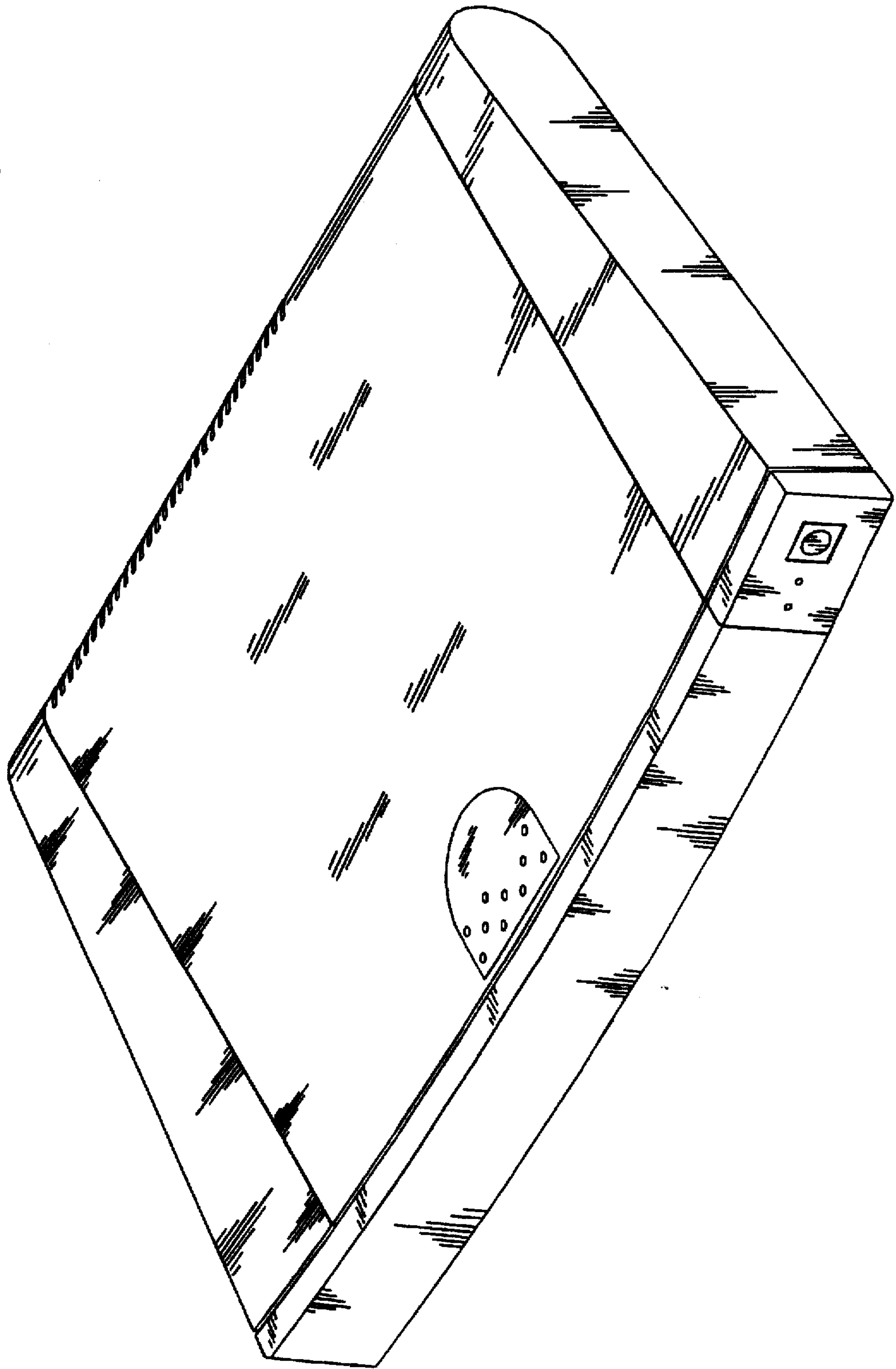

FIG. 2

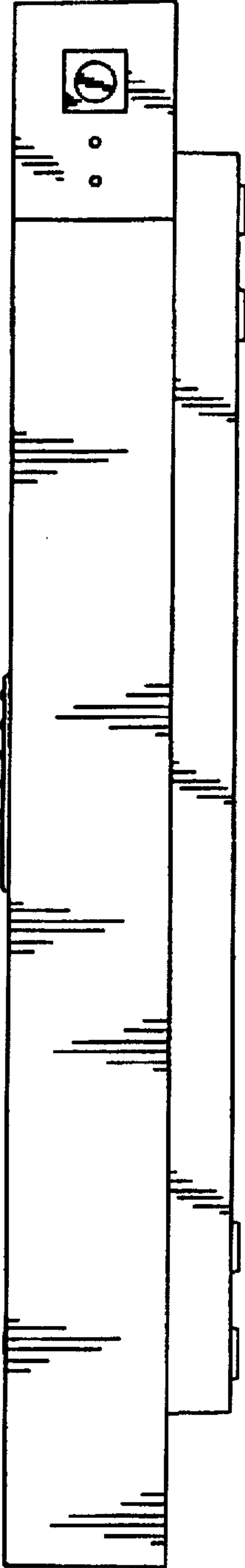

FIG. 3

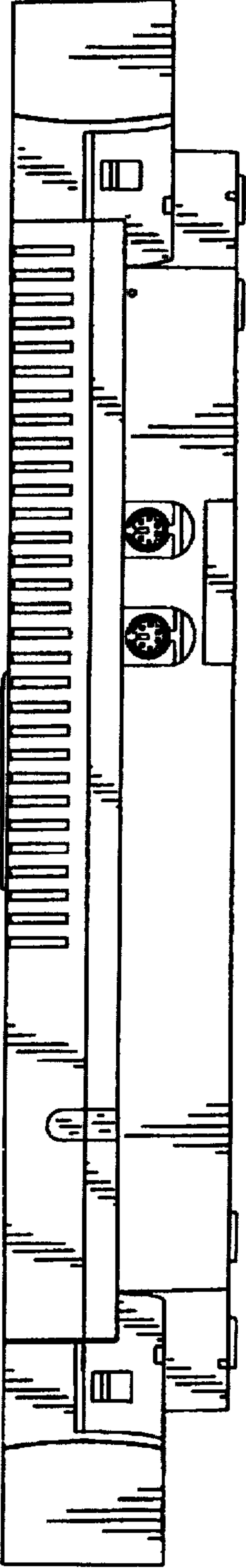

FIG. 4

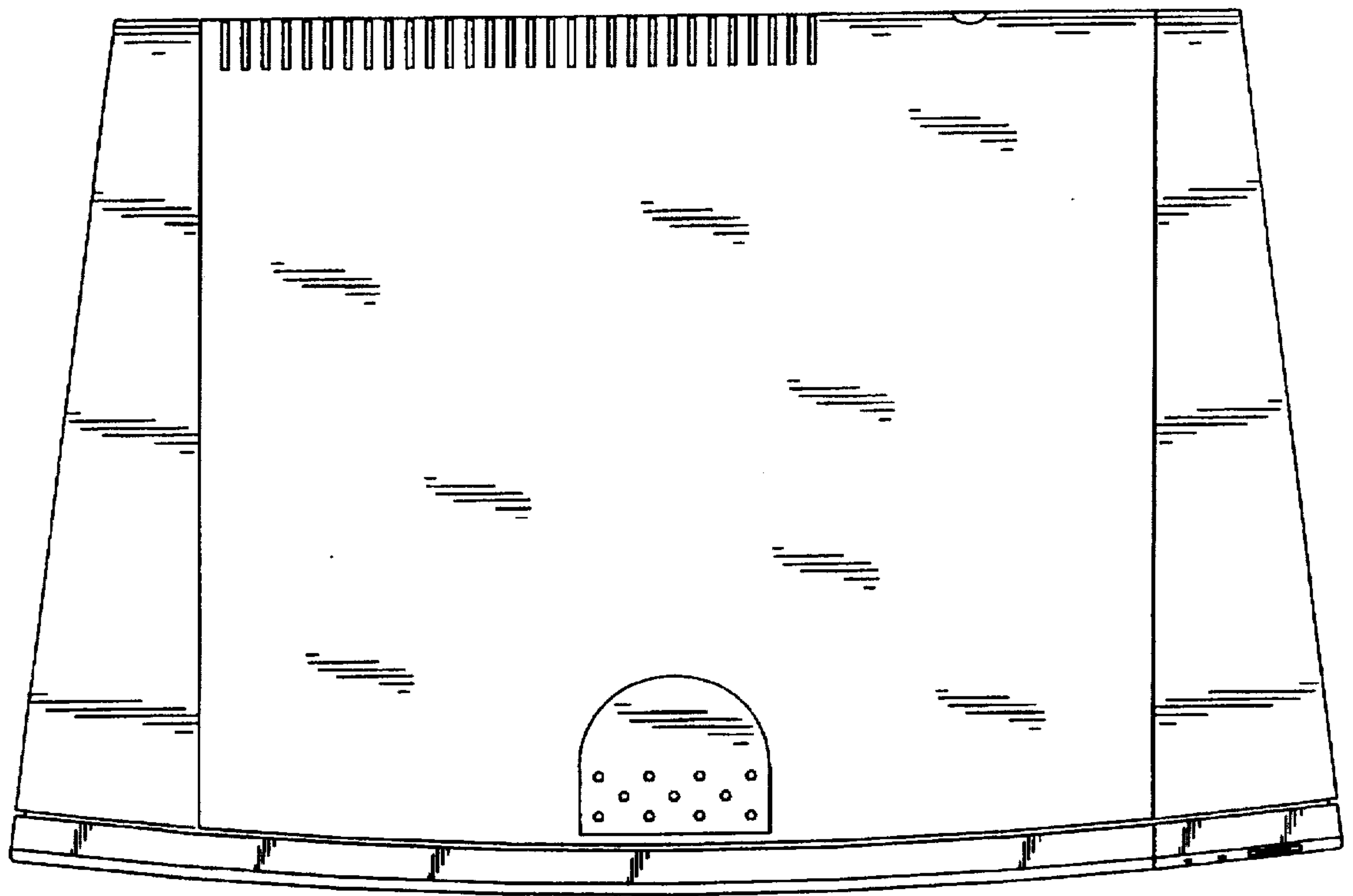

FIG. 5

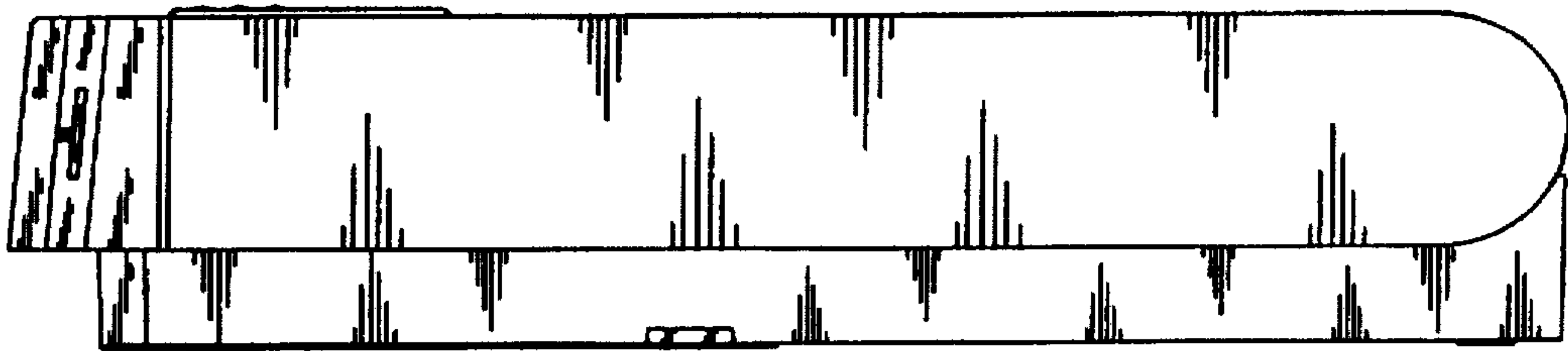

FIG. 6

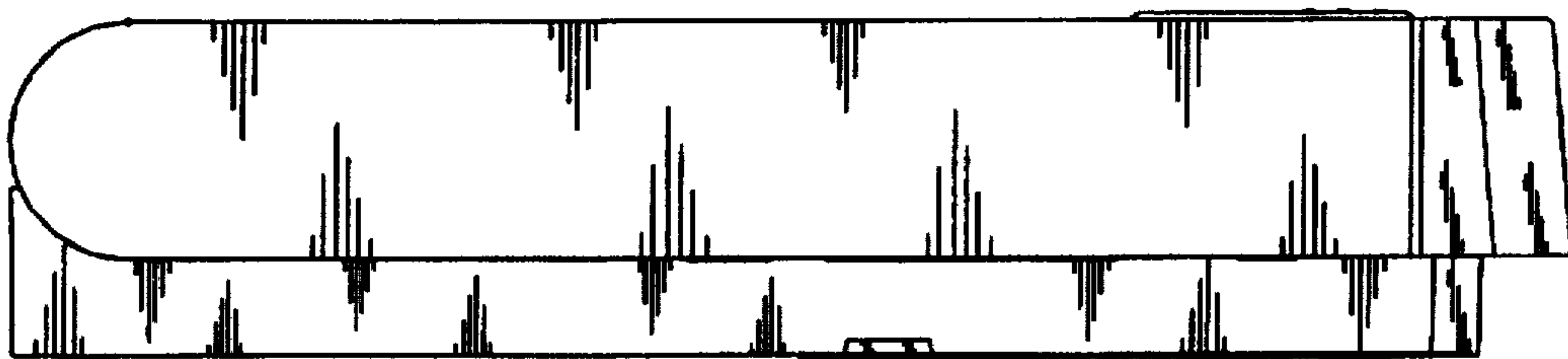

FIG. 7

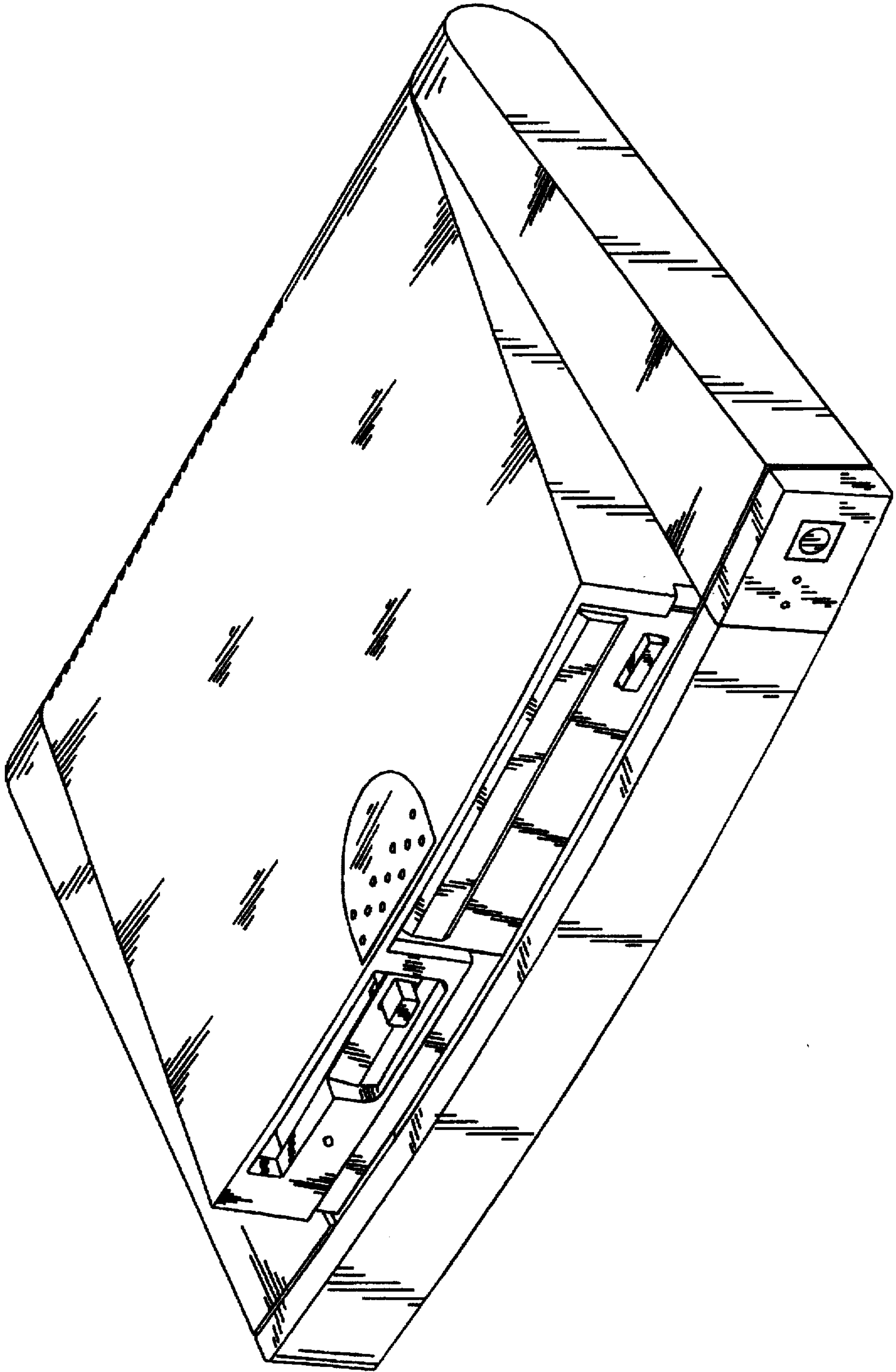

FIG. 8

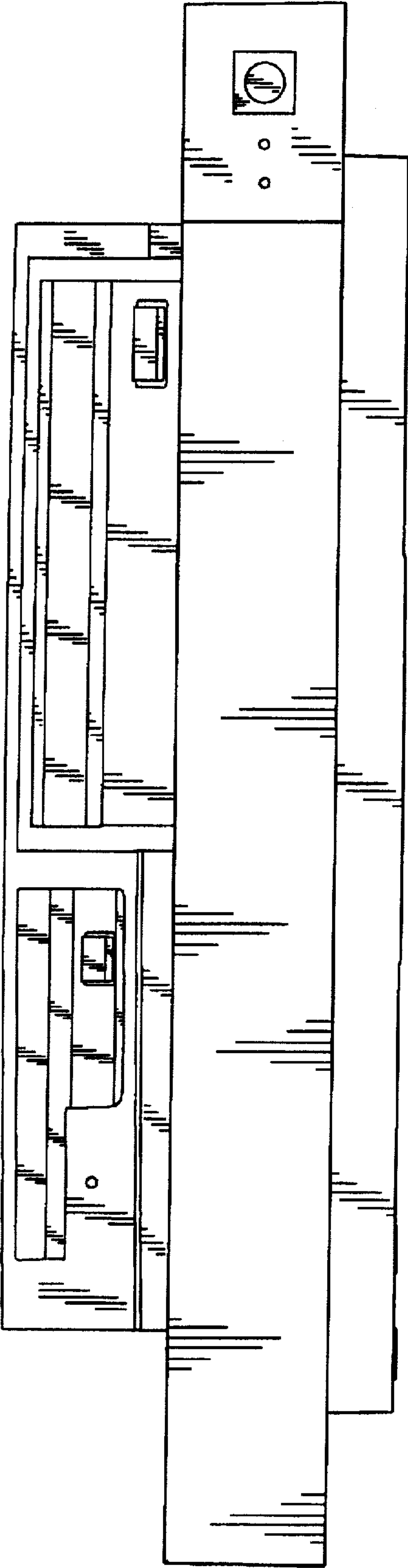

FIG. 9

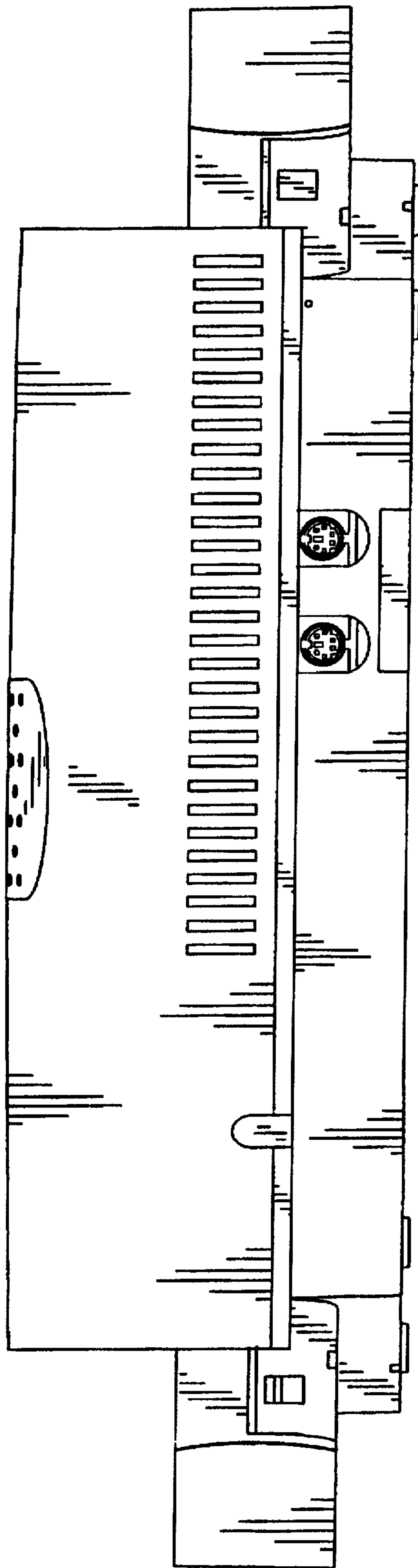

FIG. 10

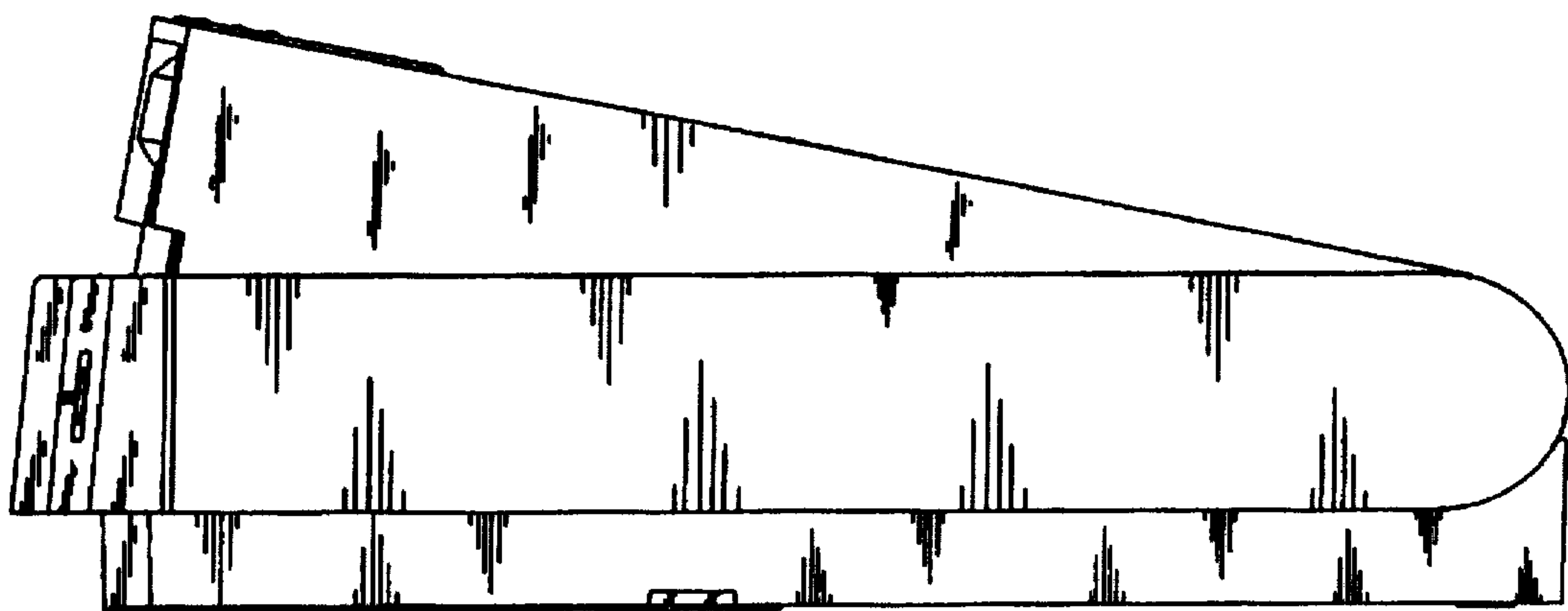

FIG. 11

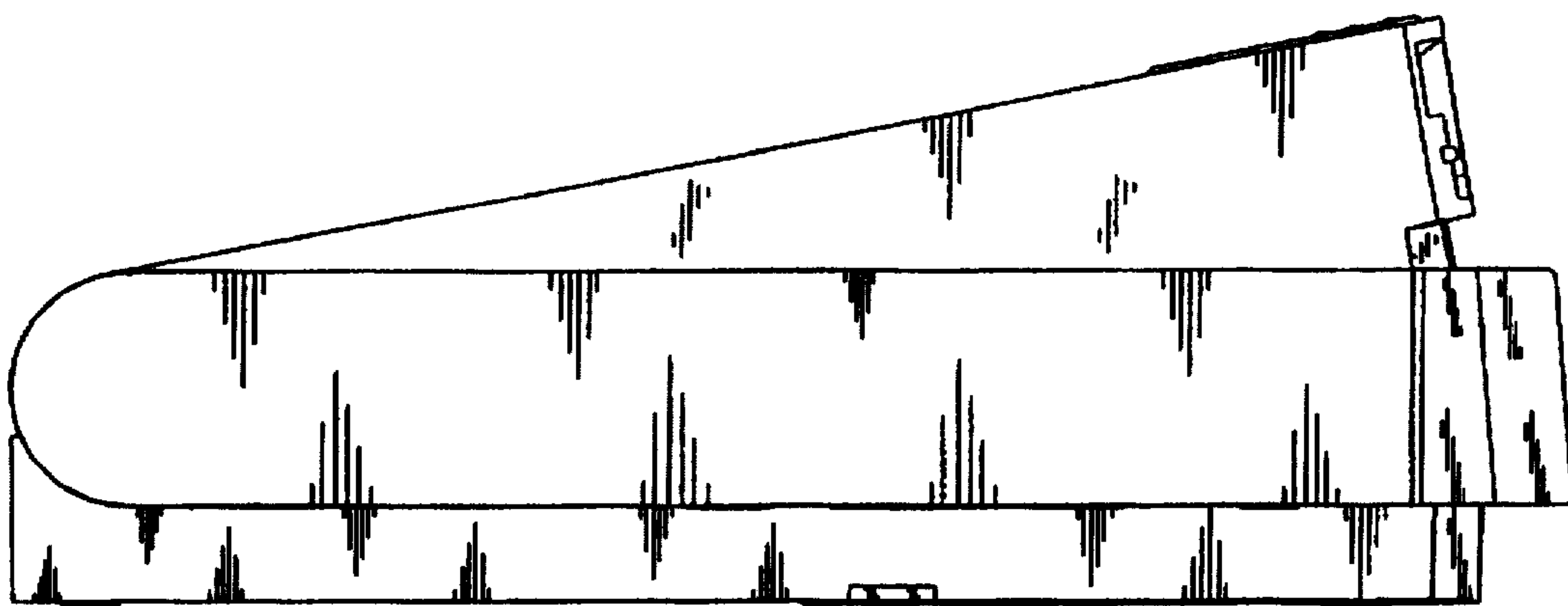

FIG. 12

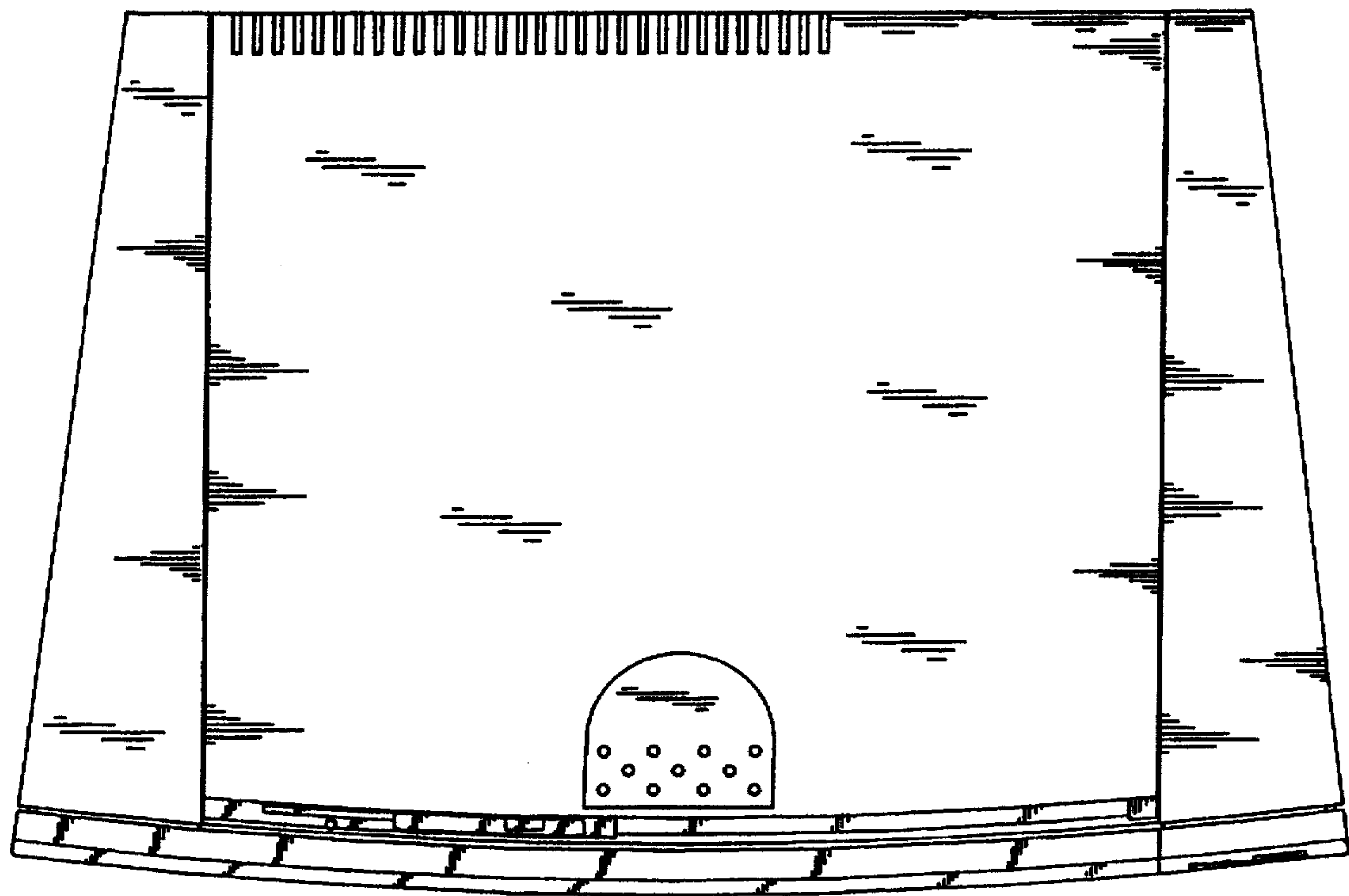

FIG. 13

