

US00D386056S

United States Patent [19]
Streeter

[11] **Patent Number: Des. 386,056**
[45] **Date of Patent: **Nov. 11, 1997**

[54] **HOLDER FOR A HANGER TYPE FASTENER**

[76] **Inventor: Lawrence Streeter, P.O. Box 8653,
Benton Harbor, Mich. 49022**

[**] **Term: 14 Years**

[21] **Appl. No.: 53,547**

[22] **Filed: Apr. 24, 1996**

[51] **LOC (6) Cl. 08-01**

[52] **U.S. Cl. D8/70**

[58] **Field of Search D8/70, 71; D15/140;
279/62, 140, 902, 142, 143, 144, 145**

[56] **References Cited**

U.S. PATENT DOCUMENTS

D. 245,395	8/1977	Cognevich	D8/70
D. 270,032	8/1983	Mayo	D8/70
D. 319,764	9/1991	McCord, Jr.	D8/70
3,744,807	7/1973	Spires et al.	279/145
5,191,666	3/1993	Corbin	279/145 X

Primary Examiner—Antoine Duval Davis
Attorney, Agent, or Firm—Baker & Daniels

[57] **CLAIM**

The ornamental design for a holder for a hanger type fastener, as shown and described.

DESCRIPTION

FIG. 1 is a left side perspective view of a holder for a hanger type fastener showing my new design;
FIG. 2 is a top plan view thereof, the bottom plan view being a mirror image;
FIG. 3 is a front end view thereof;
FIG. 4 is a rear end view thereof; and
FIG. 5 is a right side view thereof, the left side view being a mirror image;
FIG. 6 is a right side perspective view of a holder for a hanger type fastener showing another embodiment of my new design;
FIG. 7 is a top plan view thereof, the bottom plan view being a mirror image;
FIG. 8 is a front end view thereof;
FIG. 9 is a rear end view thereof; and,
FIG. 10 is a right side view thereof, the left side view forming a mirror image.

1 Claim, 2 Drawing Sheets

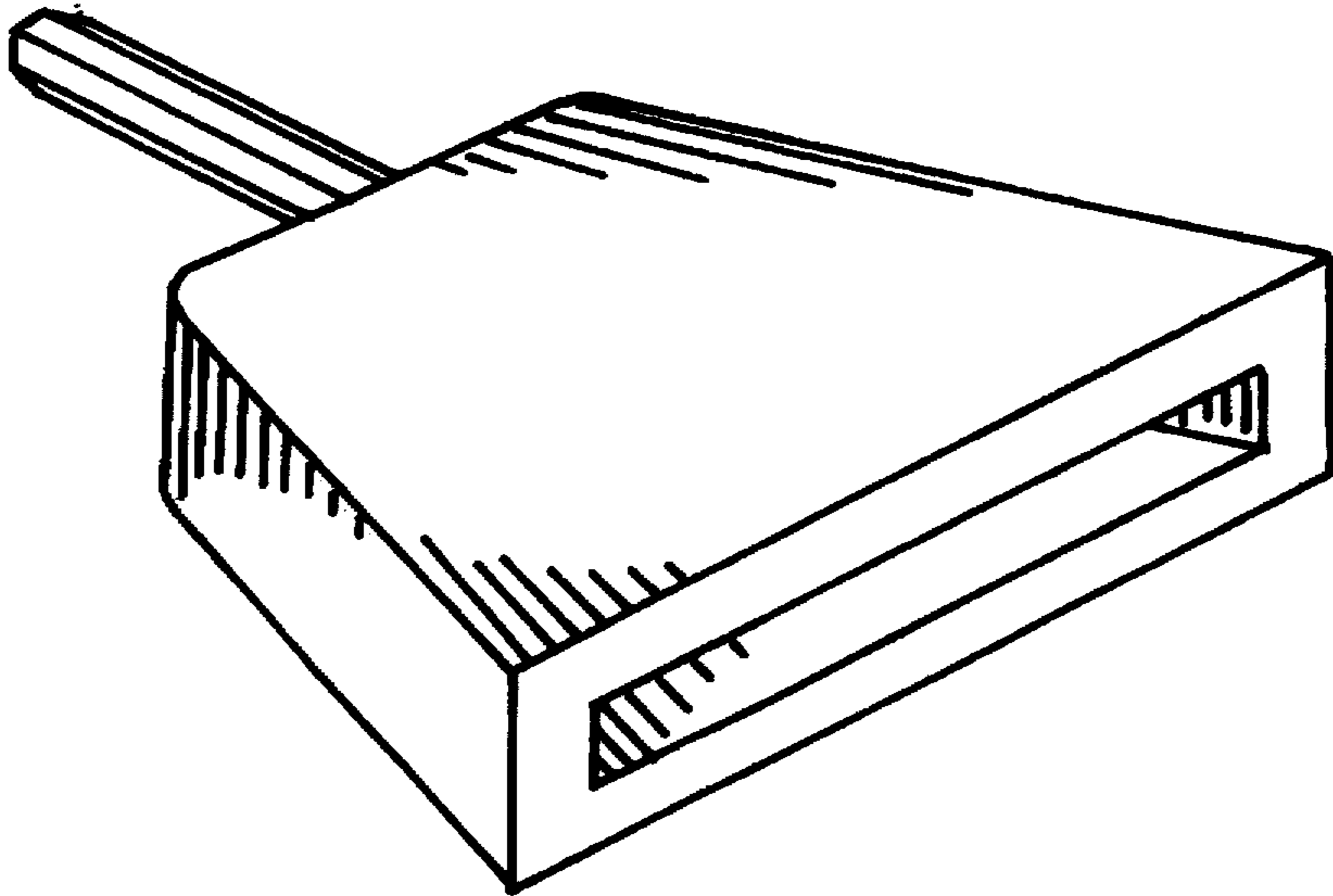

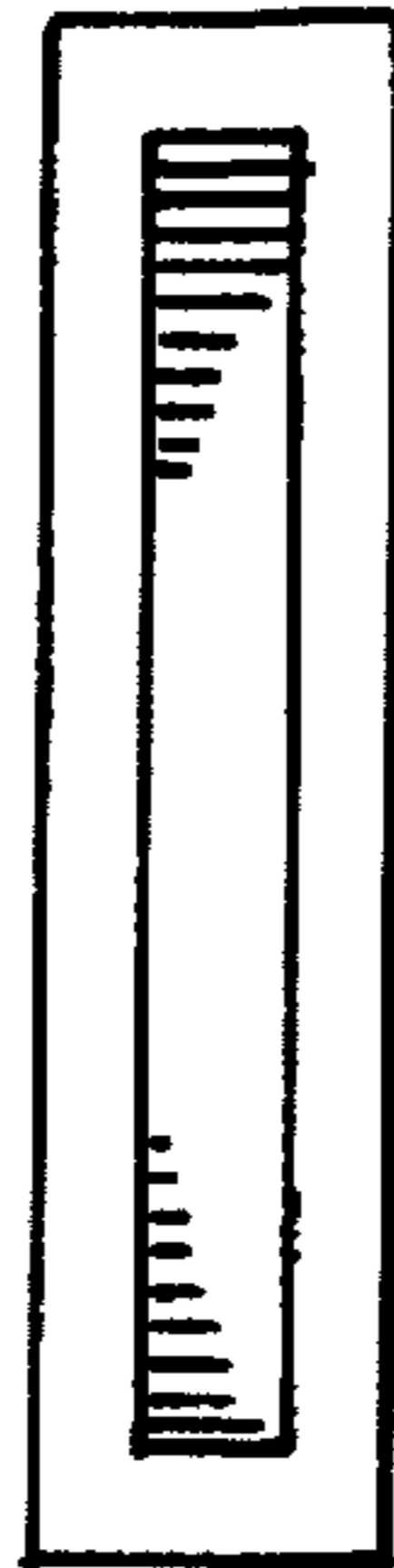
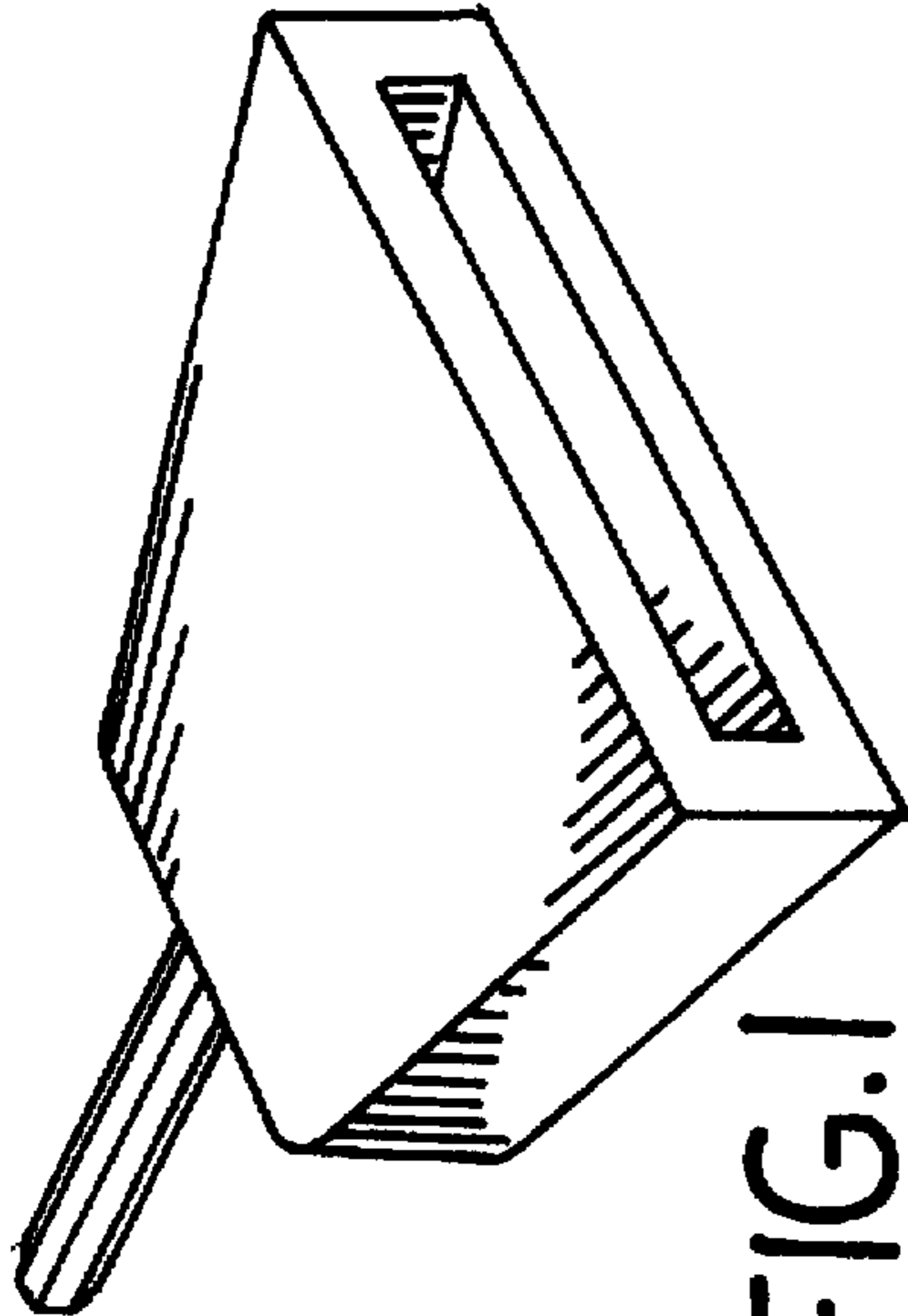
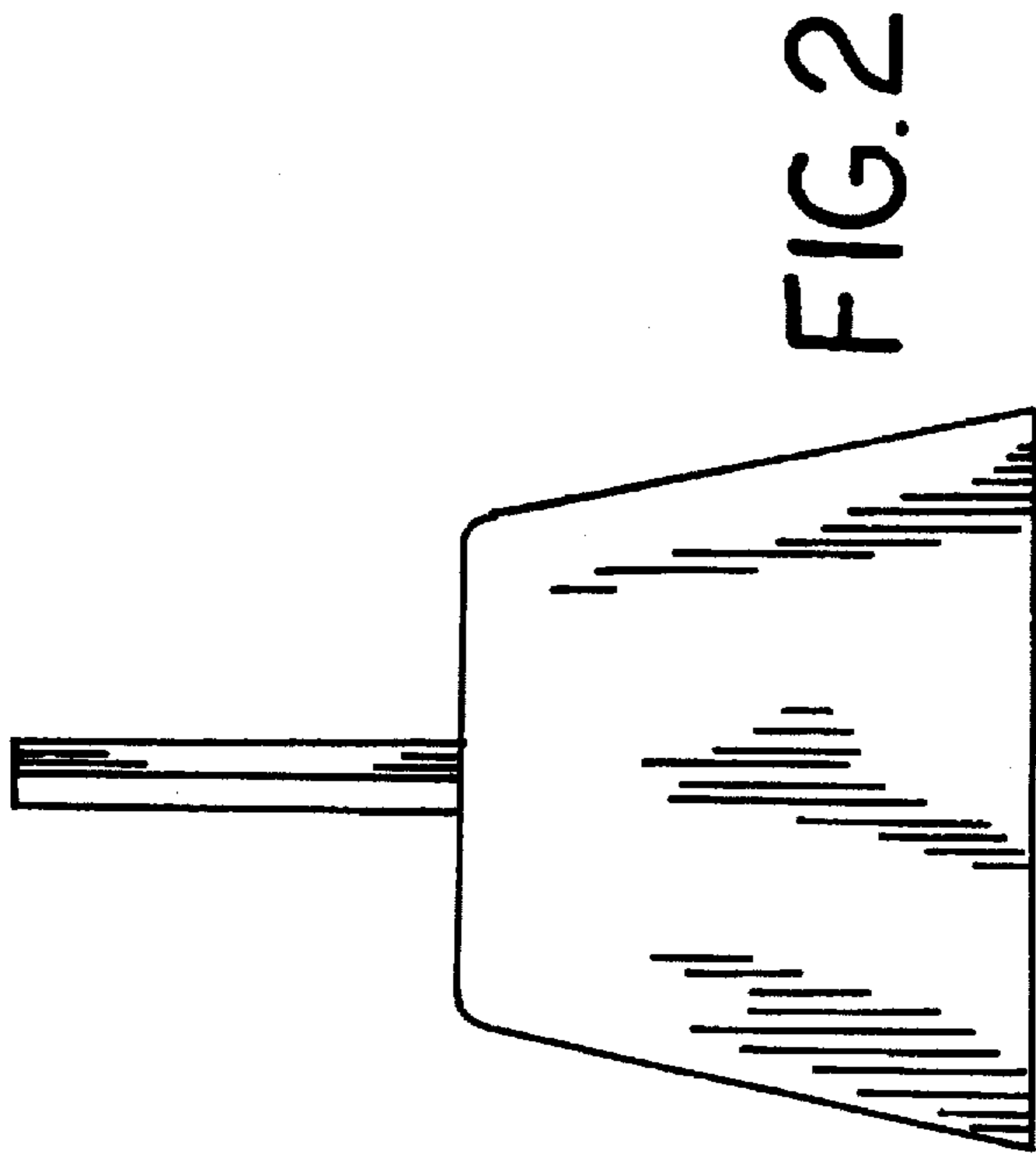

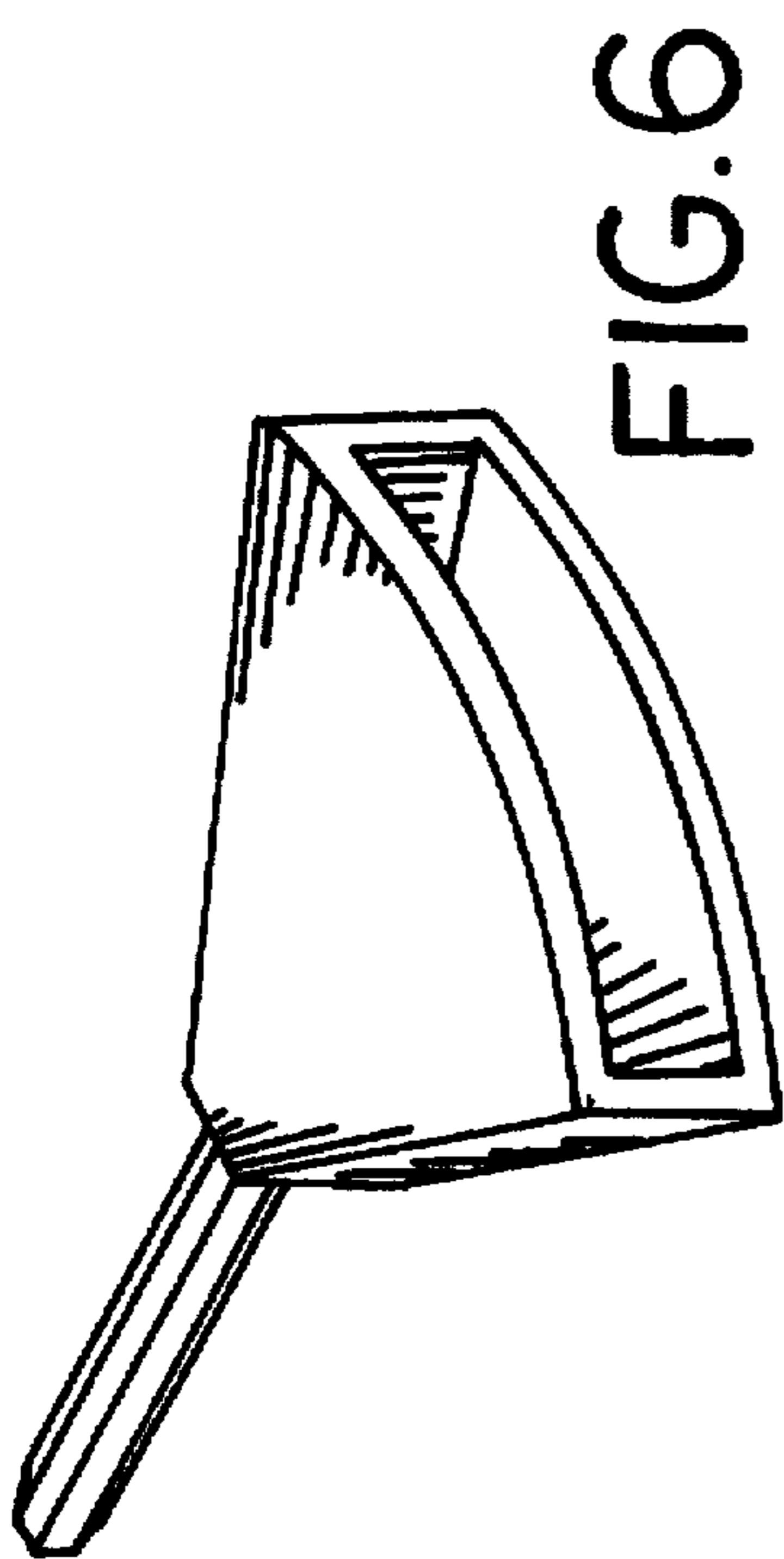

FIG. 6

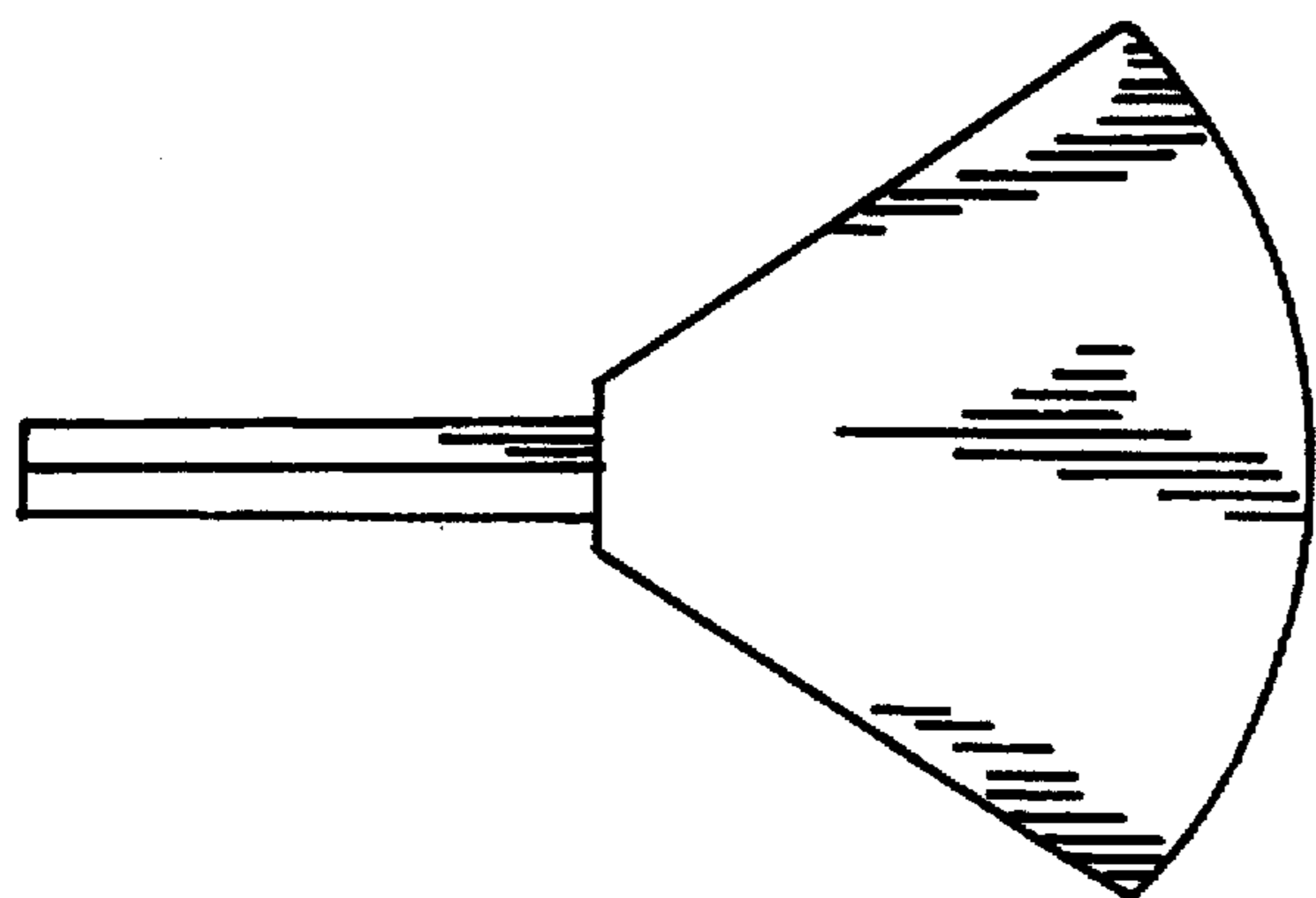

FIG. 7



FIG. 8



FIG. 10



FIG. 9