



US00D386000S

United States Patent [19] Cretinon

[11] Patent Number: **Des. 386,000**

[45] Date of Patent: ****Nov. 11, 1997**

[54] **SPORT BOOT COLLAR**

[75] Inventor: **Fredéric Cretinon, Poisy, France**

[73] Assignee: **Salomon S.A., Annecy, France**

[**] Term: **14 Years**

[21] Appl. No.: **42,055**

[22] Filed: **Jul. 31, 1995**

[30] **Foreign Application Priority Data**

Jan. 30, 1995 [FR] France DM/031 932

[51] LOC (6) Cl. **02-07**

[52] U.S. Cl. **D2/978; D2/911; D2/946; D2/901**

[58] Field of Search D21/226; D2/902, D2/911, 946, 969, 970, 978, 973, 976; 36/50.1, 50.5, 89, 114, 120, 101

[56] **References Cited**

U.S. PATENT DOCUMENTS

D. 327,360 6/1992 Graham D2/902

D. 344,119	2/1994	Johnson et al.	D21/226
3,259,950	7/1966	Jewel	36/50.5 X
5,177,884	1/1993	Rullier	36/89 X
5,327,620	7/1994	Chen	36/50.1 X

Primary Examiner—Dominic Simone
Attorney, Agent, or Firm—Pollock, Vande Sande & Priddy

[57] **CLAIM**

The ornamental design for a sport boot collar, as shown and described.

DESCRIPTION

FIG. 1 is a right side view of the sport boot collar of applicant's design;
FIG. 2 is a left side view thereof;
FIG. 3 is a perspective view thereof;
FIG. 4 is a front elevation thereof;
FIG. 5 is a rear elevation thereof;
FIG. 6 is a top plan view thereof; and,
FIG. 7 is a bottom plan view thereof.

1 Claim, 4 Drawing Sheets

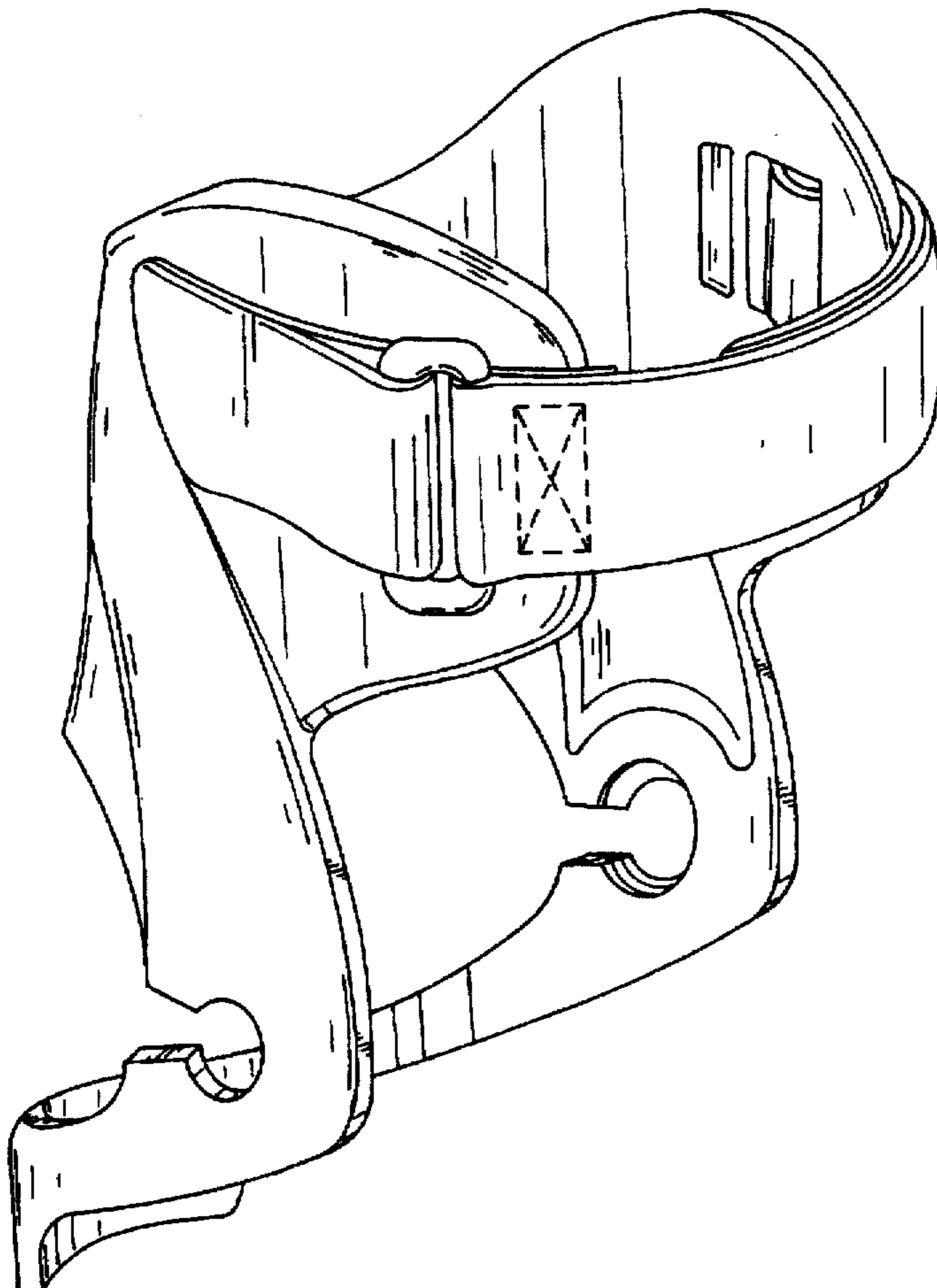

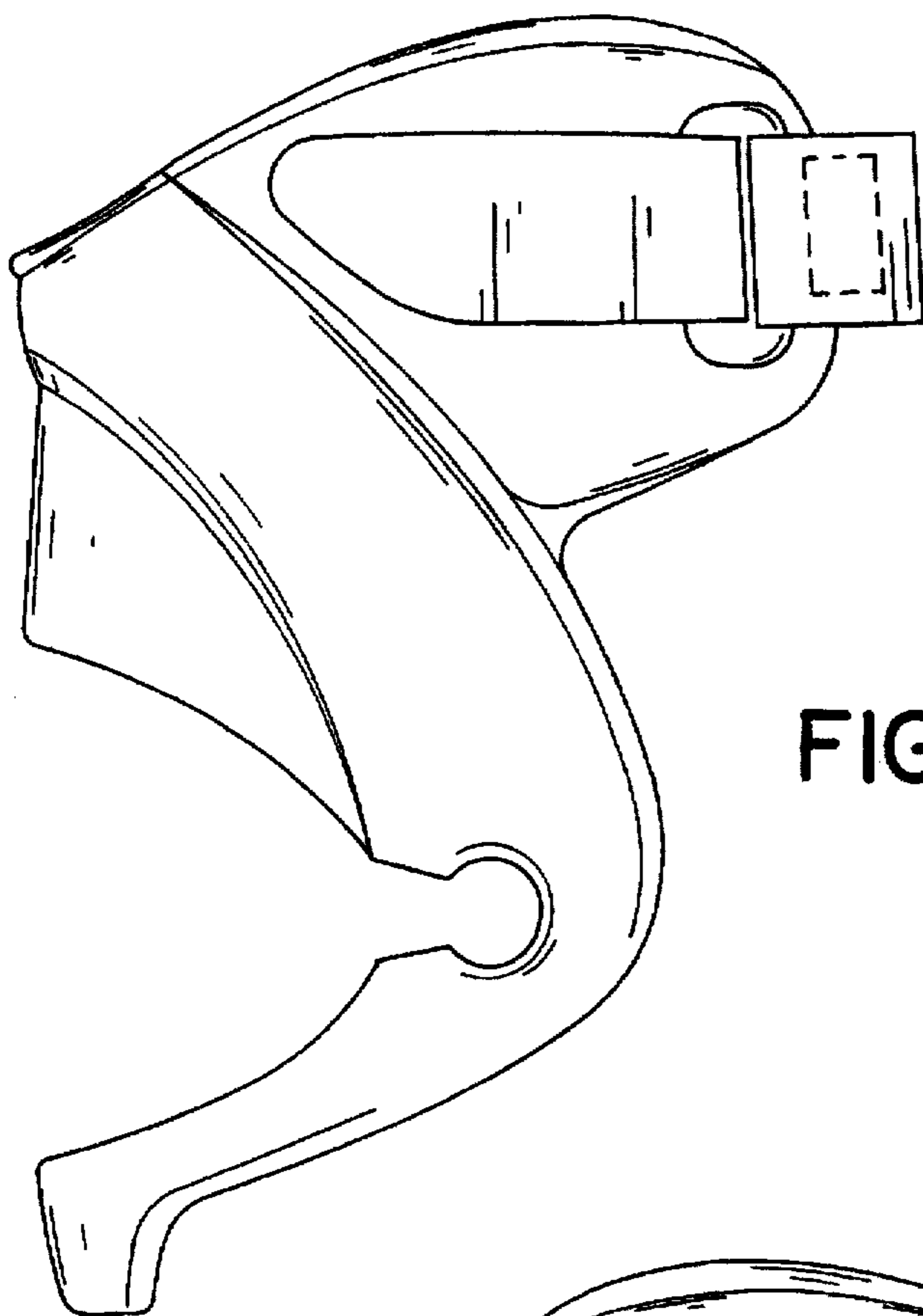

FIG. 1

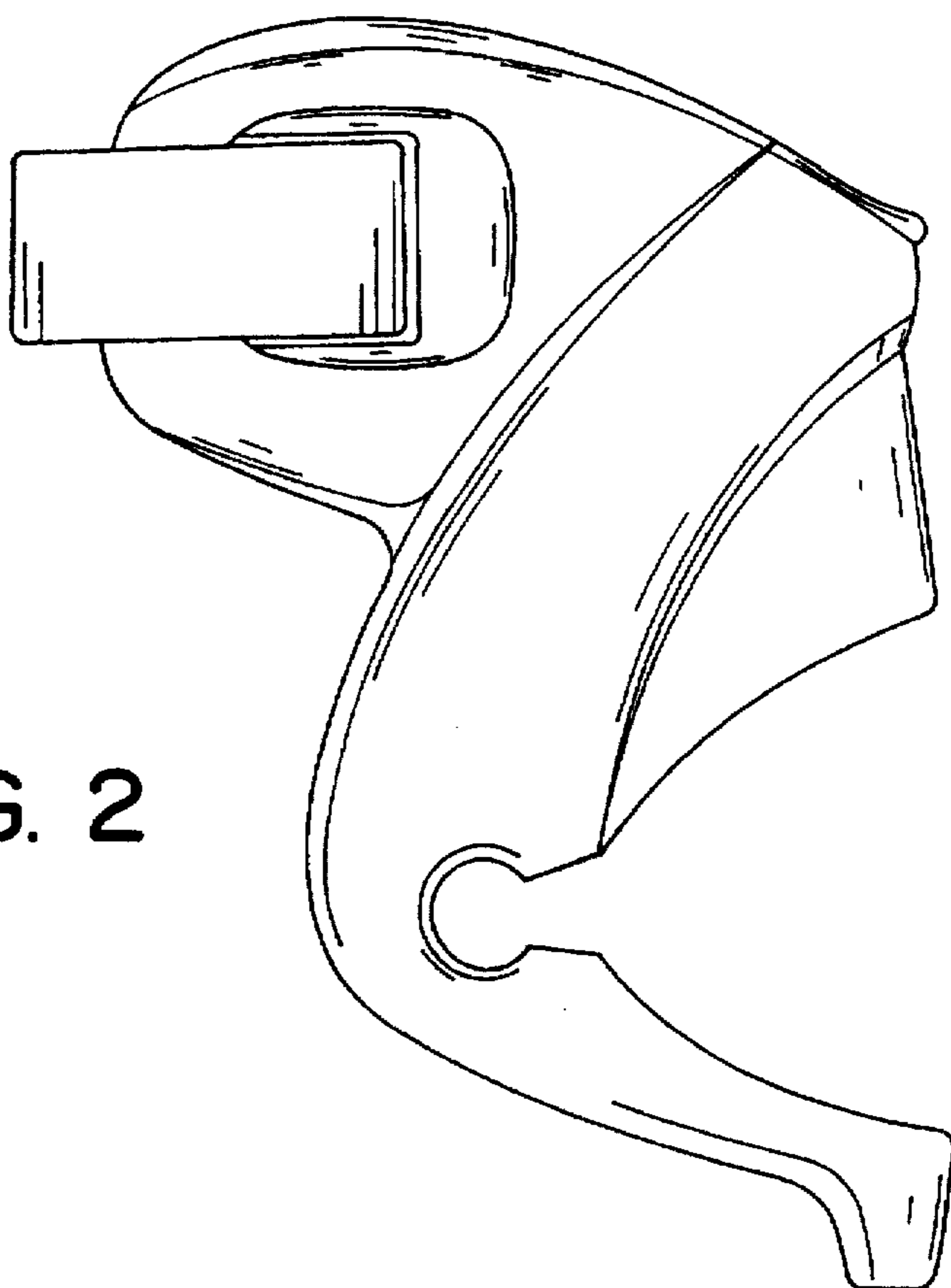

FIG. 2

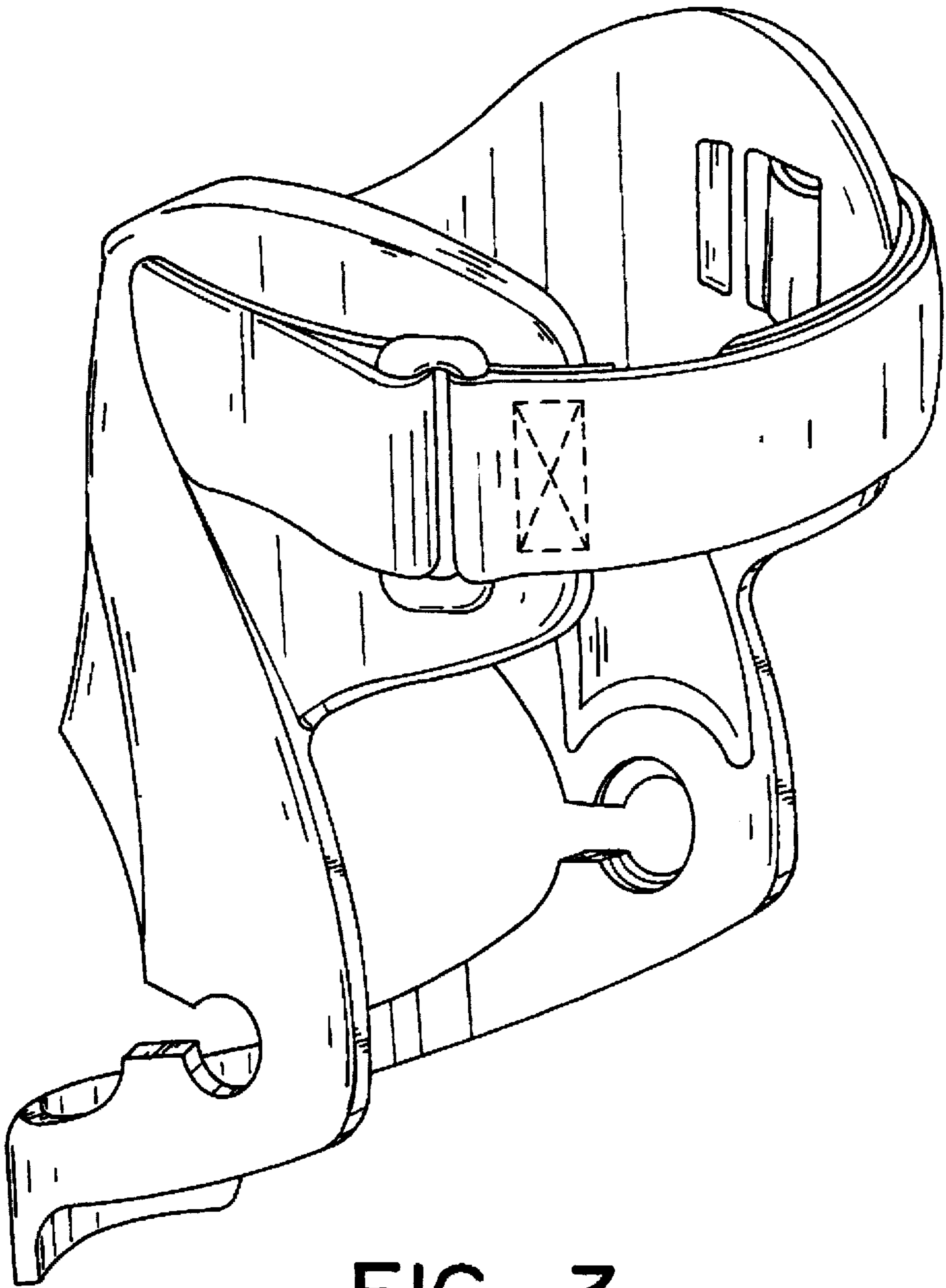

FIG. 3

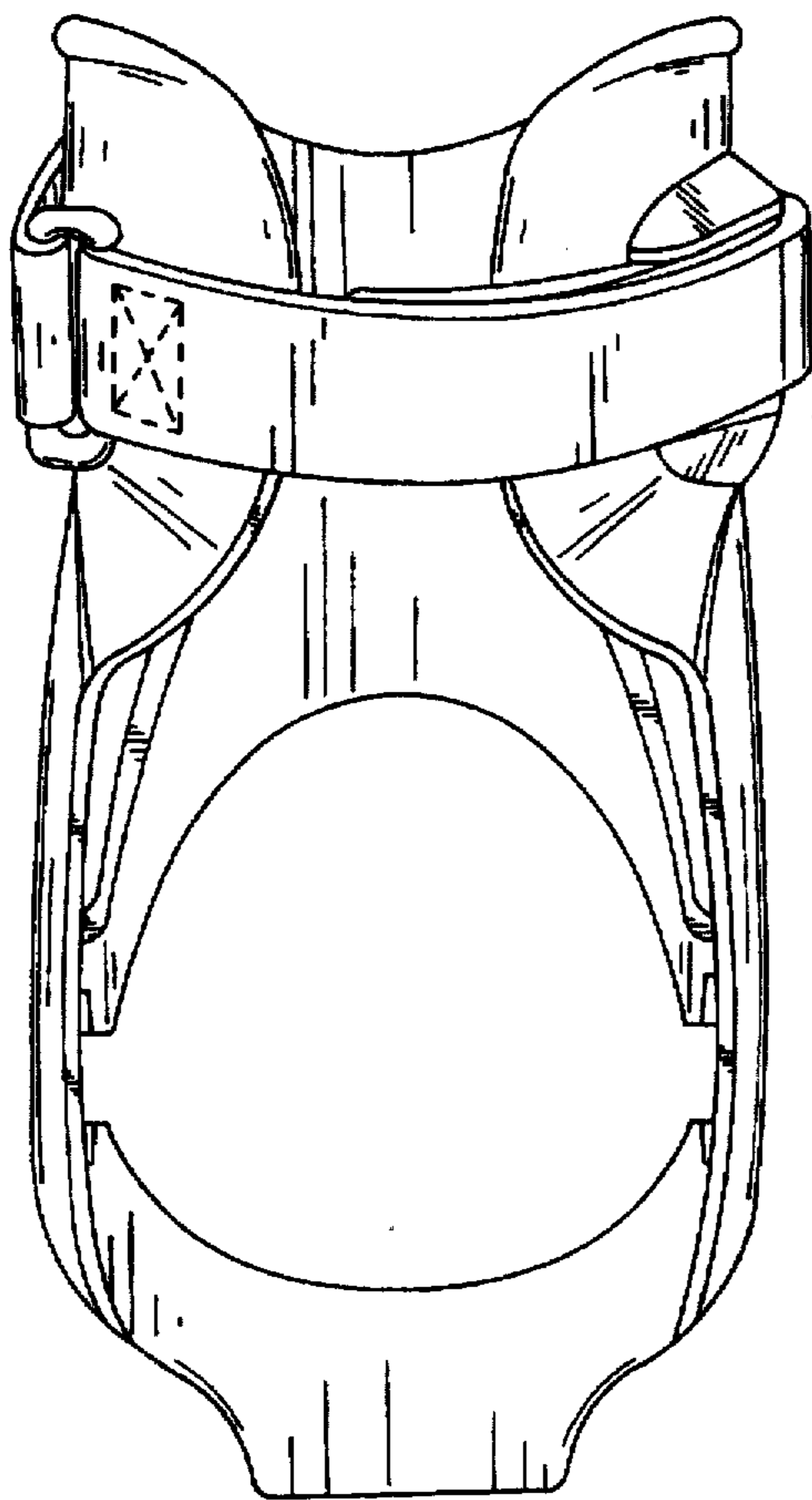

FIG. 4

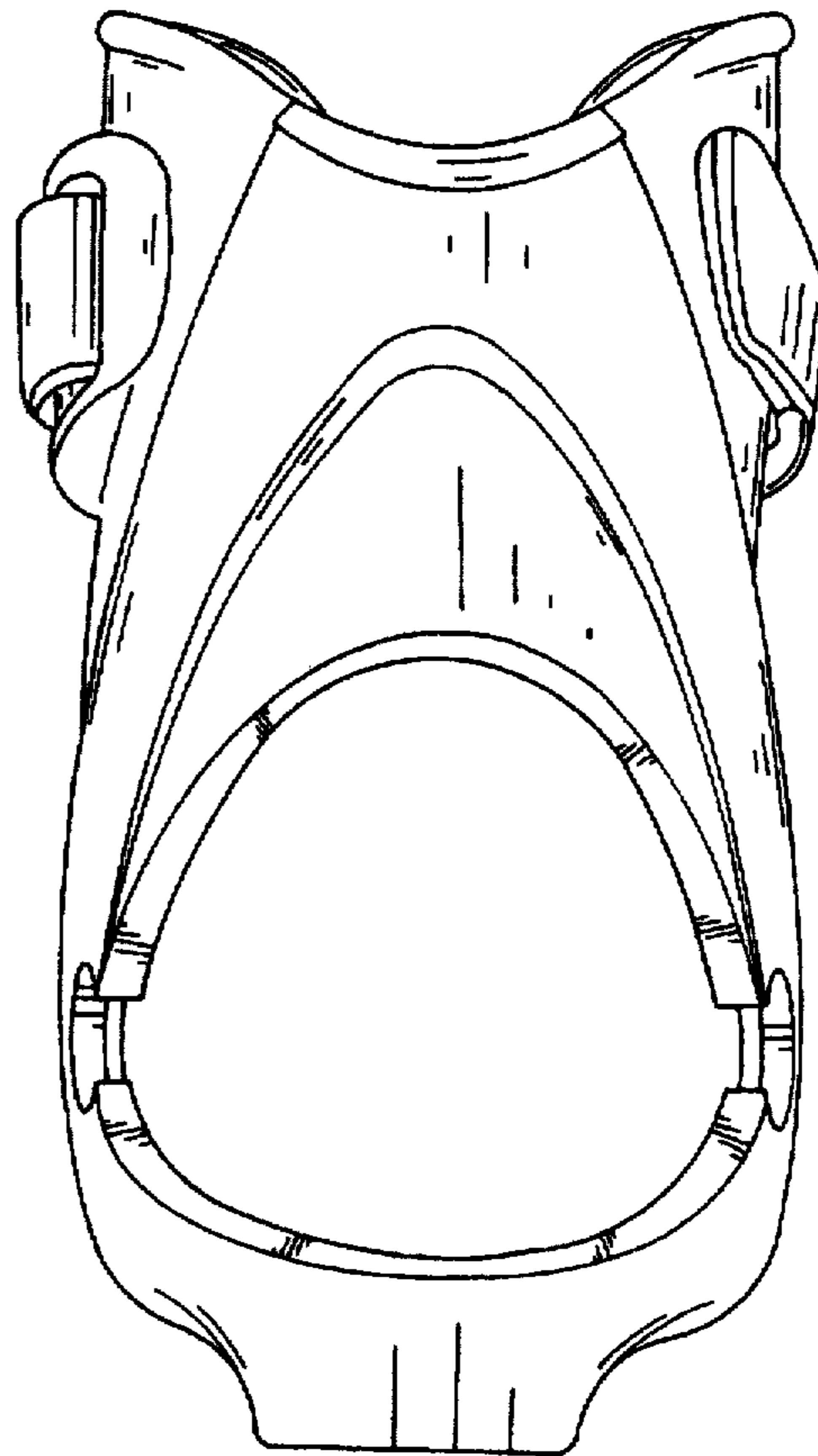

FIG. 5

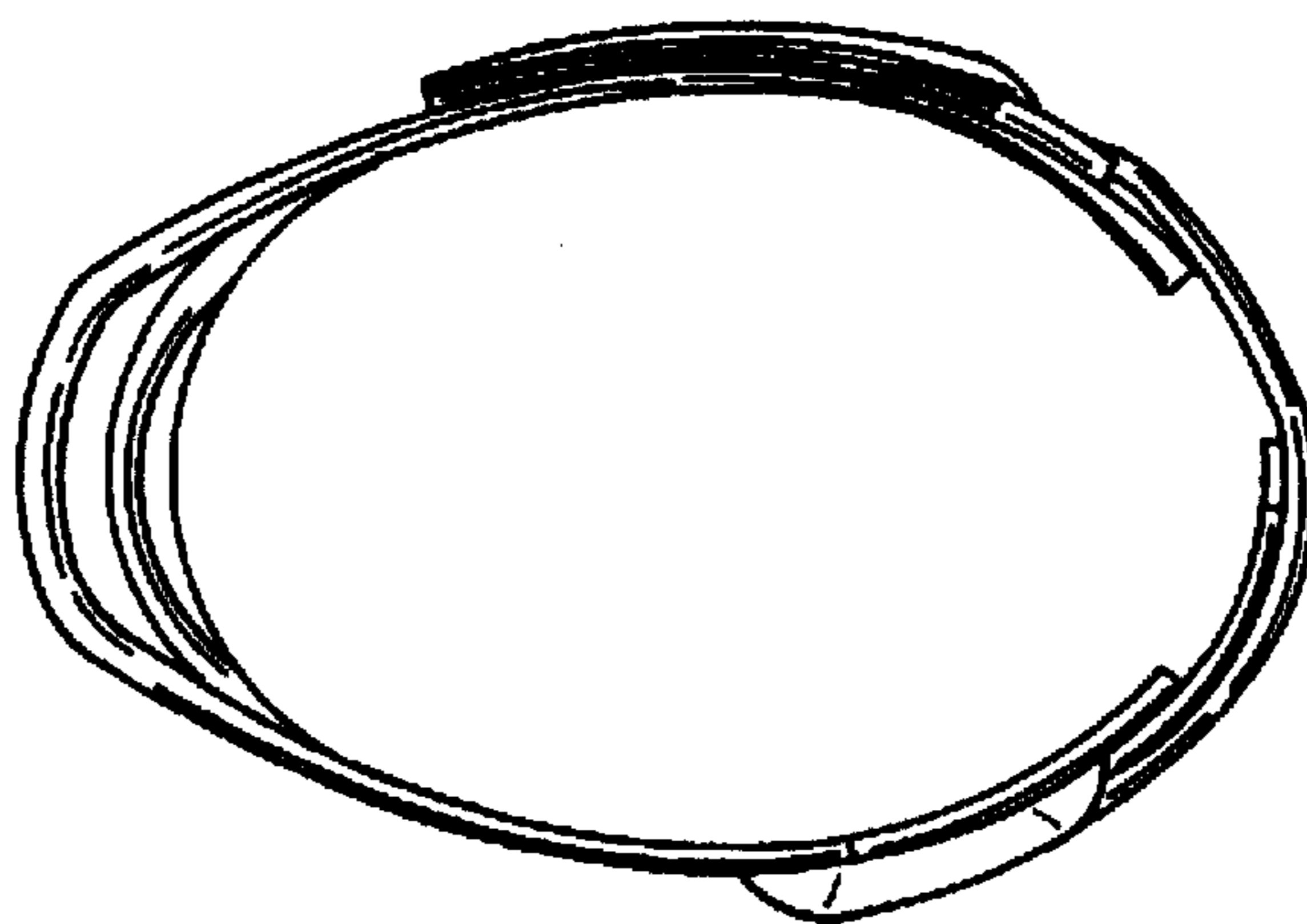

FIG. 6

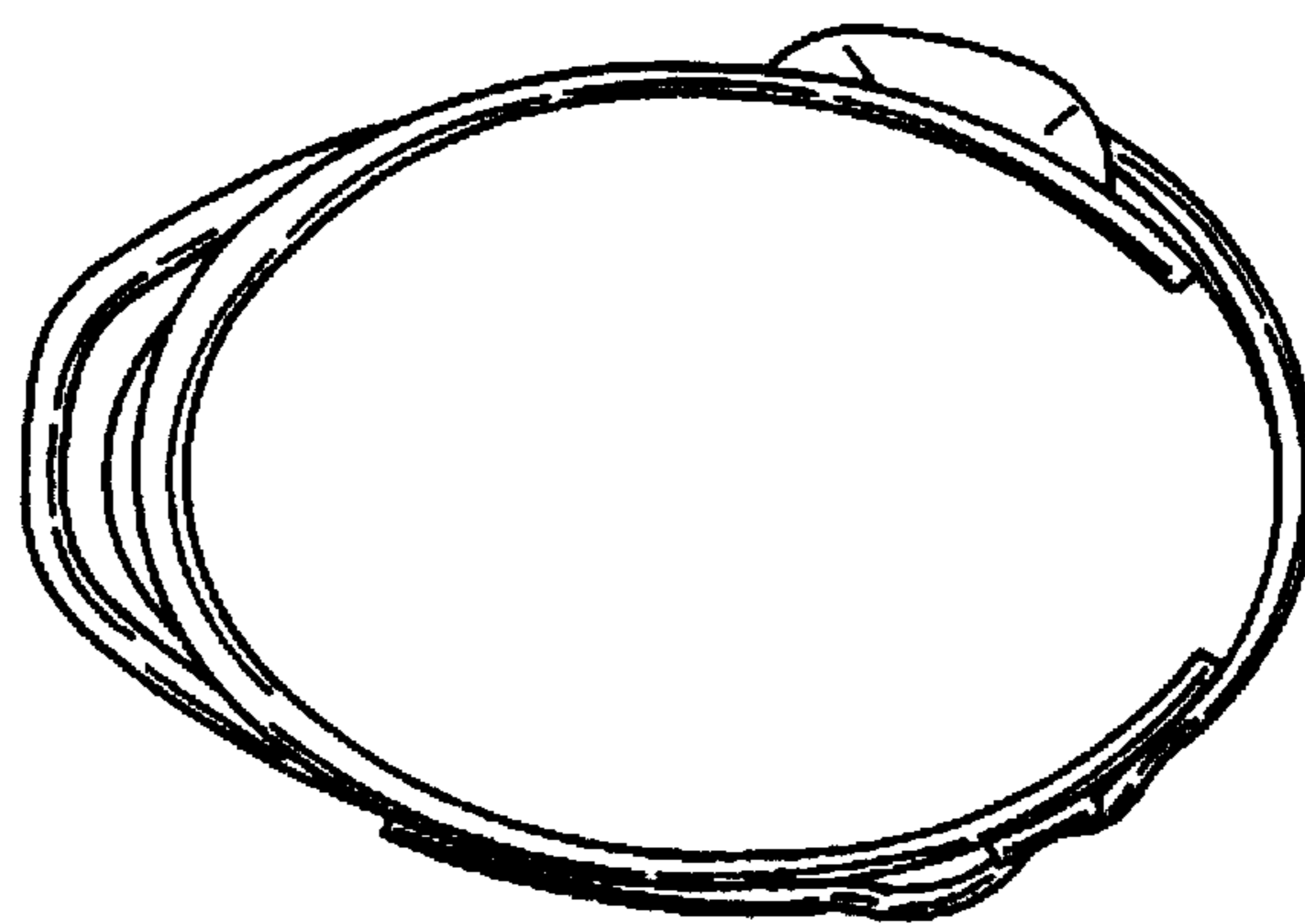

FIG. 7