



US00D385963S

United States Patent [19]

Hansson

[11] Patent Number: **Des. 385,963**

[45] Date of Patent: ****Nov. 4, 1997**

[54] **FEMURAL OSSEOIMPLANT**

[75] Inventor: **Henrik Hansson, Linköping, Sweden**

[73] Assignee: **Collux AB, Malmo, Sweden**

[**] Term: **14 Years**

[21] Appl. No.: **27,441**

[22] Filed: **Aug. 22, 1994**

[30] **Foreign Application Priority Data**

Feb. 21, 1994 [SE] Sweden 94-0425

[51] LOC (6) Cl. **24-03**

[52] U.S. Cl. **D24/155**

[58] Field of Search D24/155; 623/23,
623/65, 67-69, 71, 73

[56] **References Cited**

U.S. PATENT DOCUMENTS

2,526,959	10/1950	Lorenzo	128/92
2,612,159	6/1952	Collison	128/92
2,702,543	2/1955	Pugh et al.	128/92
2,801,631	8/1957	Chamley	128/92
3,374,786	3/1968	Callender, Jr.	128/92
3,400,711	9/1968	Hux et al.	128/92
3,547,114	12/1970	Haboush	128/92
3,782,374	1/1974	Fischer	128/92 BB
3,900,025	8/1975	Barnes, Jr.	128/92 D
3,987,499	10/1976	Scharbach et al.	3/1.91
3,996,931	12/1976	Callender, Jr.	128/92 BA
4,095,591	6/1978	Graham, Jr. et al.	128/92 BB
4,236,512	12/1980	Aginsky	606/68
4,379,451	4/1983	Getscher	128/92 CA
4,438,762	3/1984	Kyle	128/92 BB
4,441,492	4/1984	Rydell et al.	128/92 EB
4,628,923	12/1986	Medoff	128/92 YU
4,776,330	10/1988	Chapman et al.	128/92 YY
4,973,332	11/1990	Kummer	606/65
5,190,544	3/1993	Chapman et al.	606/71
5,484,439	1/1996	Olson et al.	606/71 X

FOREIGN PATENT DOCUMENTS

2149943 3/1973 France .

918531 9/1954 Germany .
1812973 4/1993 U.S.S.R. 606/71

OTHER PUBLICATIONS

"Massie Sliding Nail", Zimmer, Warsaw IN. 1981, Catalog, p. B170.

Primary Examiner—Stella Reid
Attorney, Agent, or Firm—Ladas & Parry

[57] **CLAIM**

The ornamental design for a femoral osseointegration, as shown and described.

DESCRIPTION

FIG. 1 is a left side elevational view of a femoral osseointegration, showing my new design, in assembled condition; FIG. 2 is a right side elevational view thereof; FIG. 3 is a bottom plan view thereof; FIG. 4 is a top plan view thereof; FIG. 5 is a left end elevational view thereof; FIG. 6 is a right end elevational view thereof; FIG. 7 is a bottom plan view showing an angle member and a holder of the implant in separated condition; FIG. 8 is a top plan view of the separated angle member and holder; FIG. 9 is a left end elevational view of the separated angle member and holder; FIG. 10 is a right end elevational view of the separated angle member and holder; FIG. 11 is a left side elevational view of the separated angle member and holder; FIG. 12 is a right side elevational view of the separated angle member and holder; FIG. 13 is a top, left perspective view showing the separated angle member and holder; FIG. 14 is a bottom, front perspective view of the holder; and, FIG. 15 is a top perspective view of the femoral osseointegration in assembled condition.

1 Claim, 12 Drawing Sheets

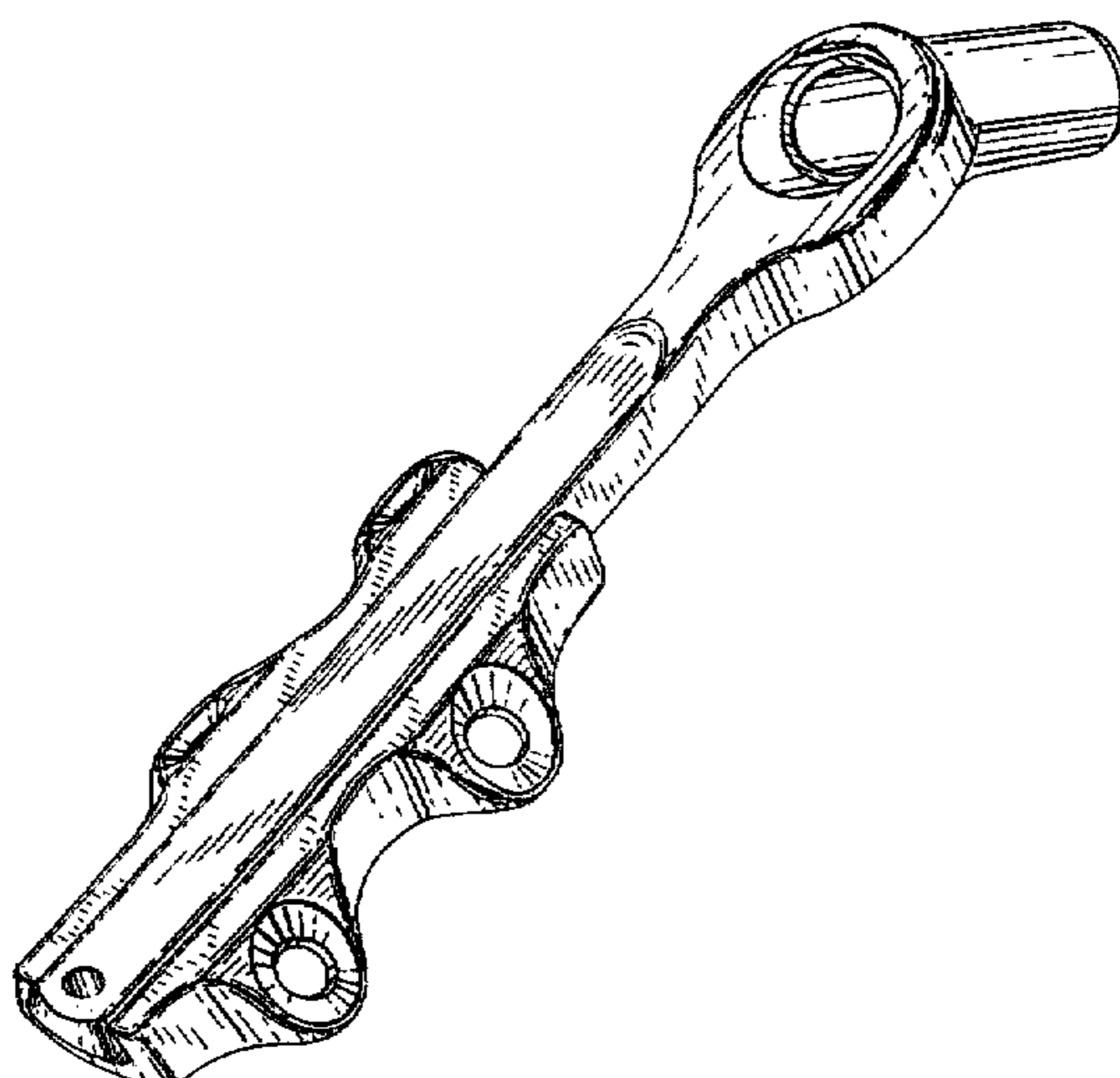

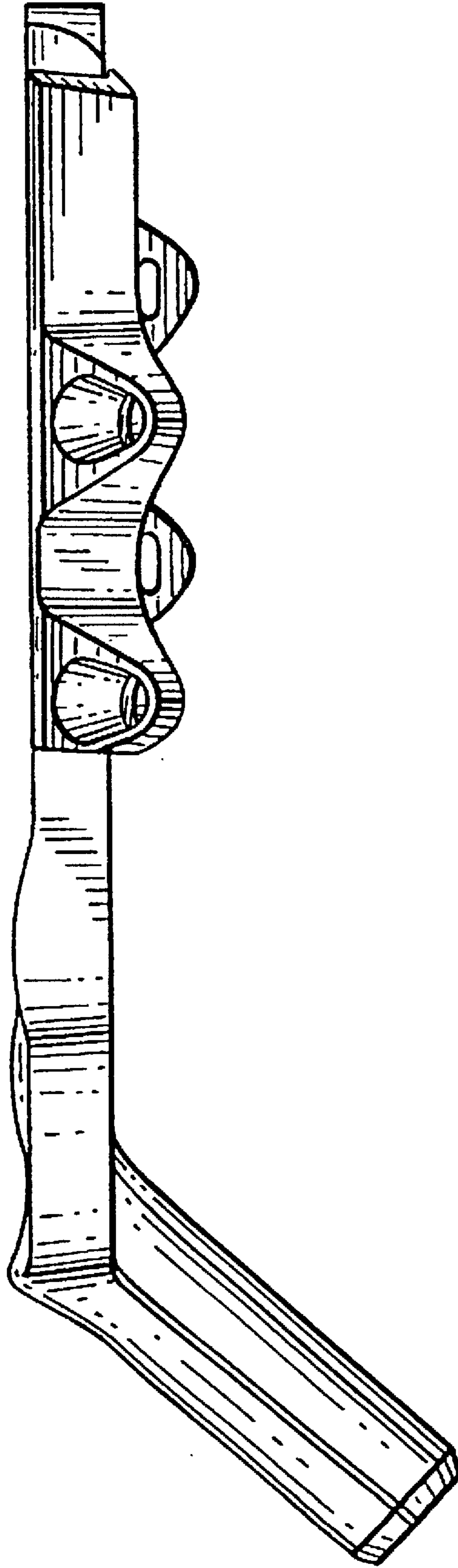

FIG. 1

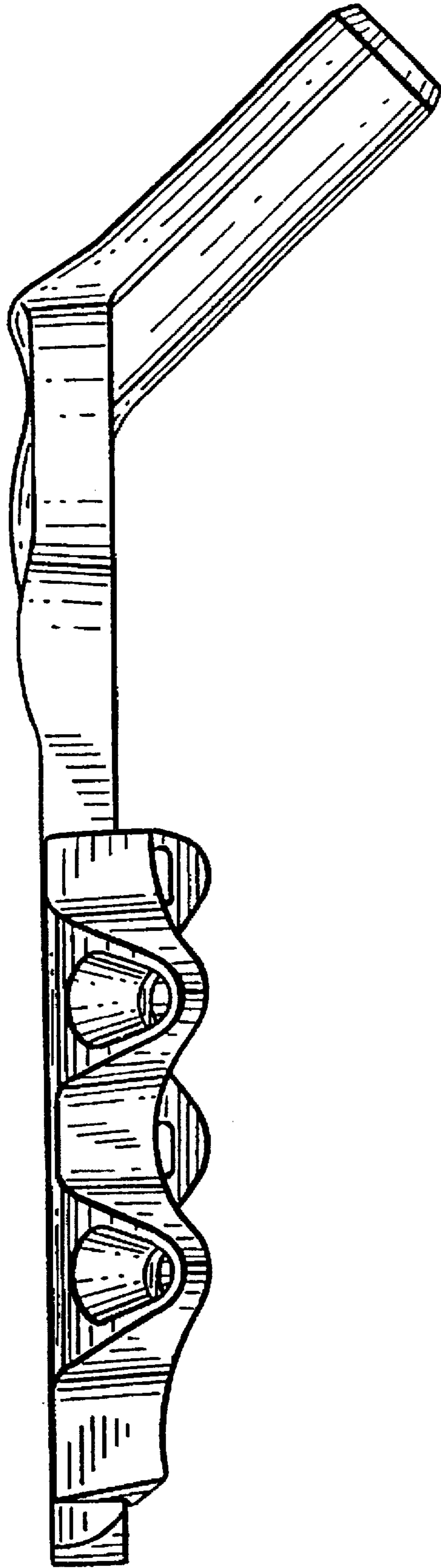

FIG. 2

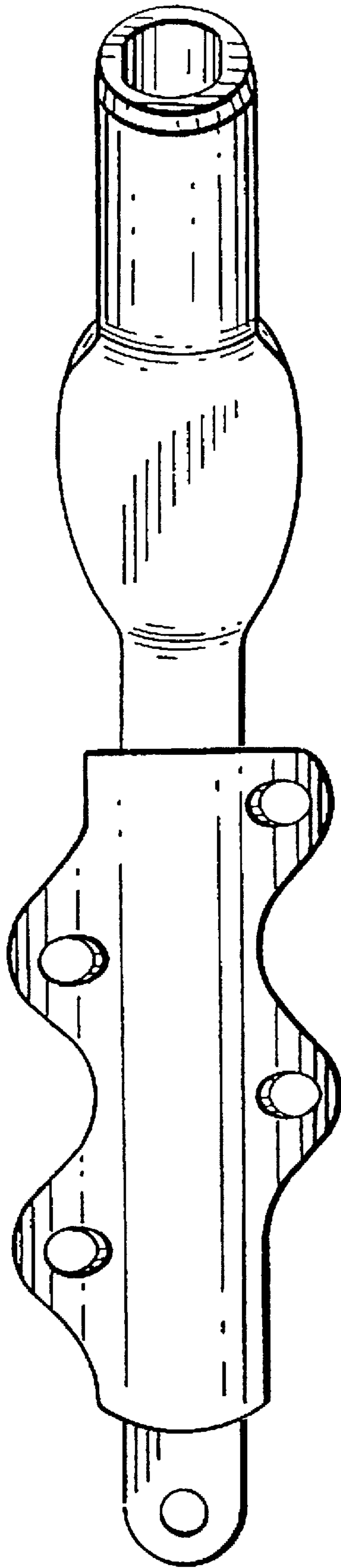

FIG. 3

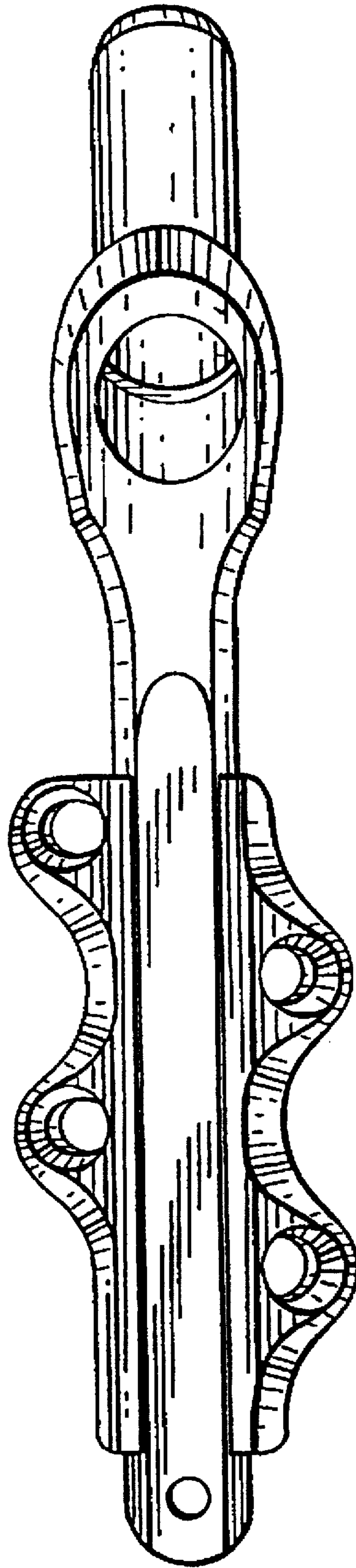

FIG. 4

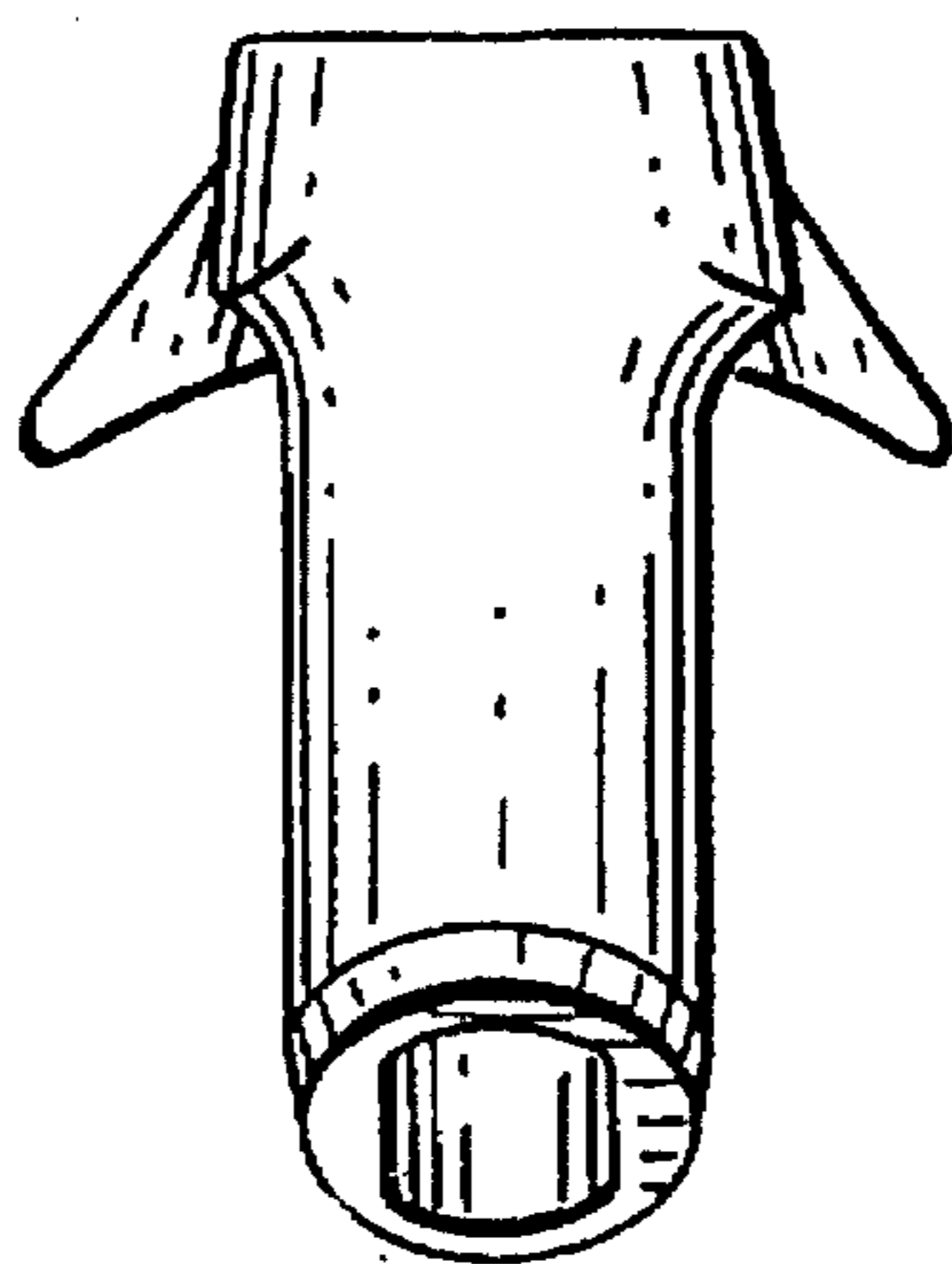

FIG. 5

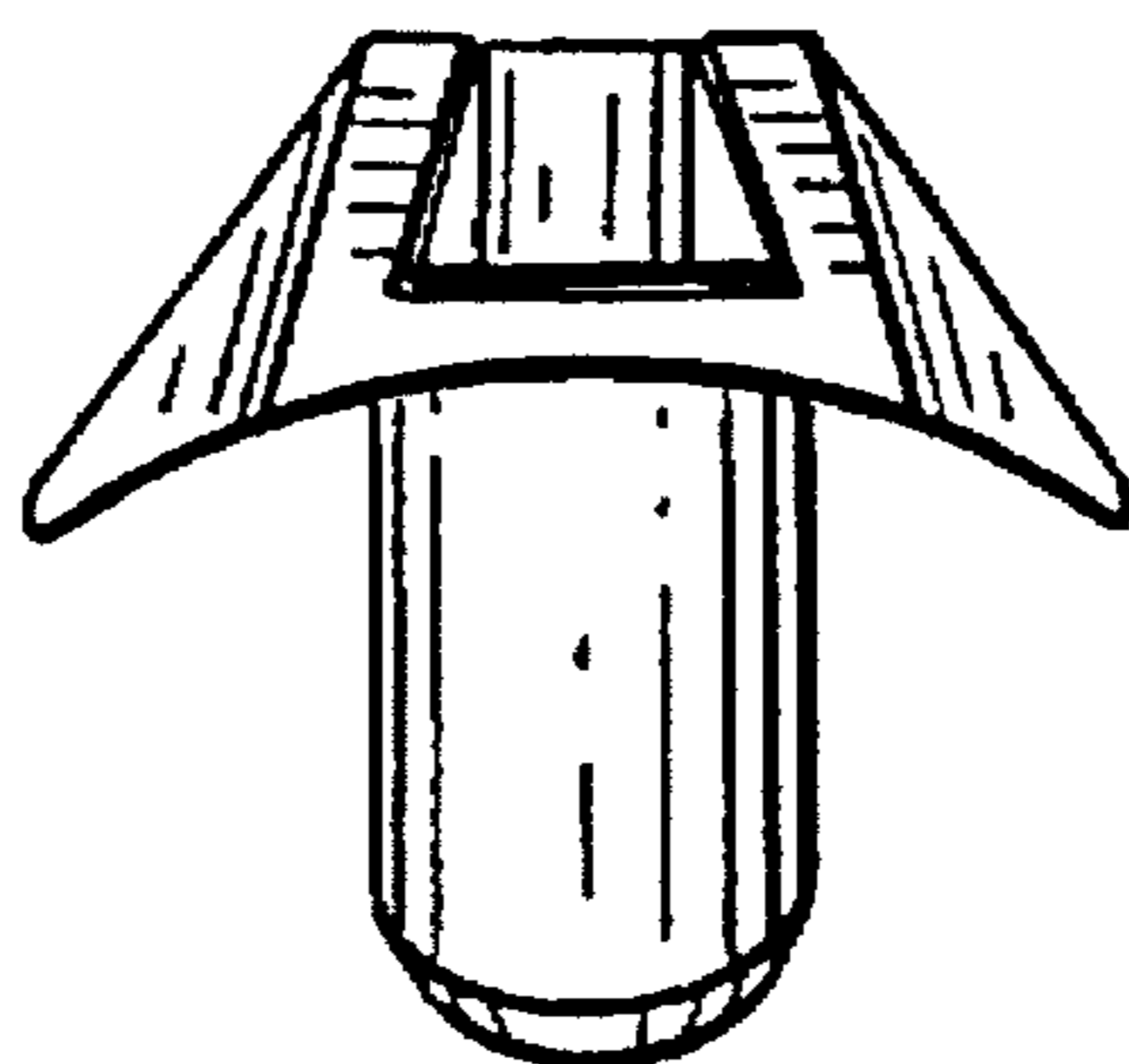

FIG. 6

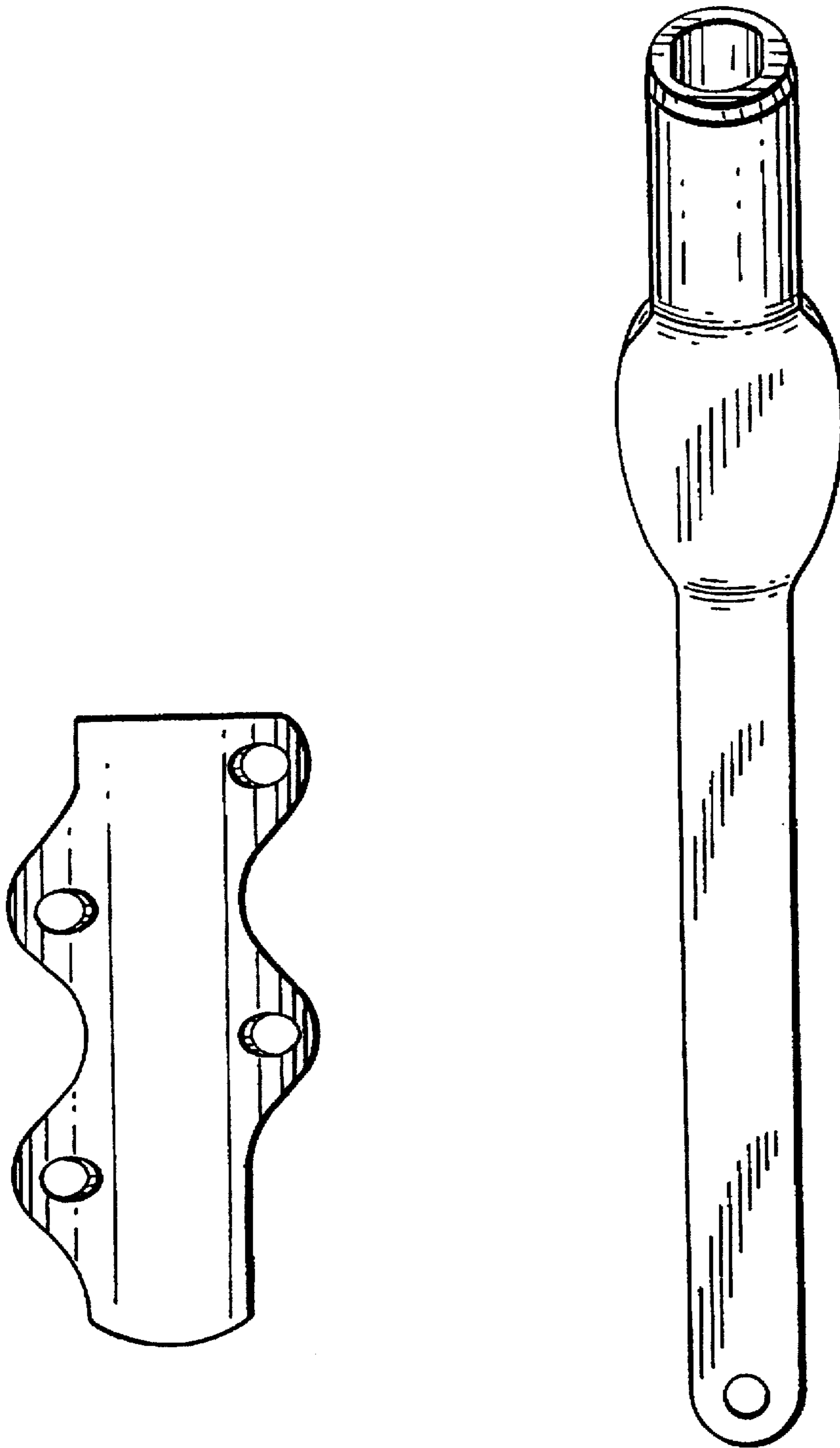

FIG. 7

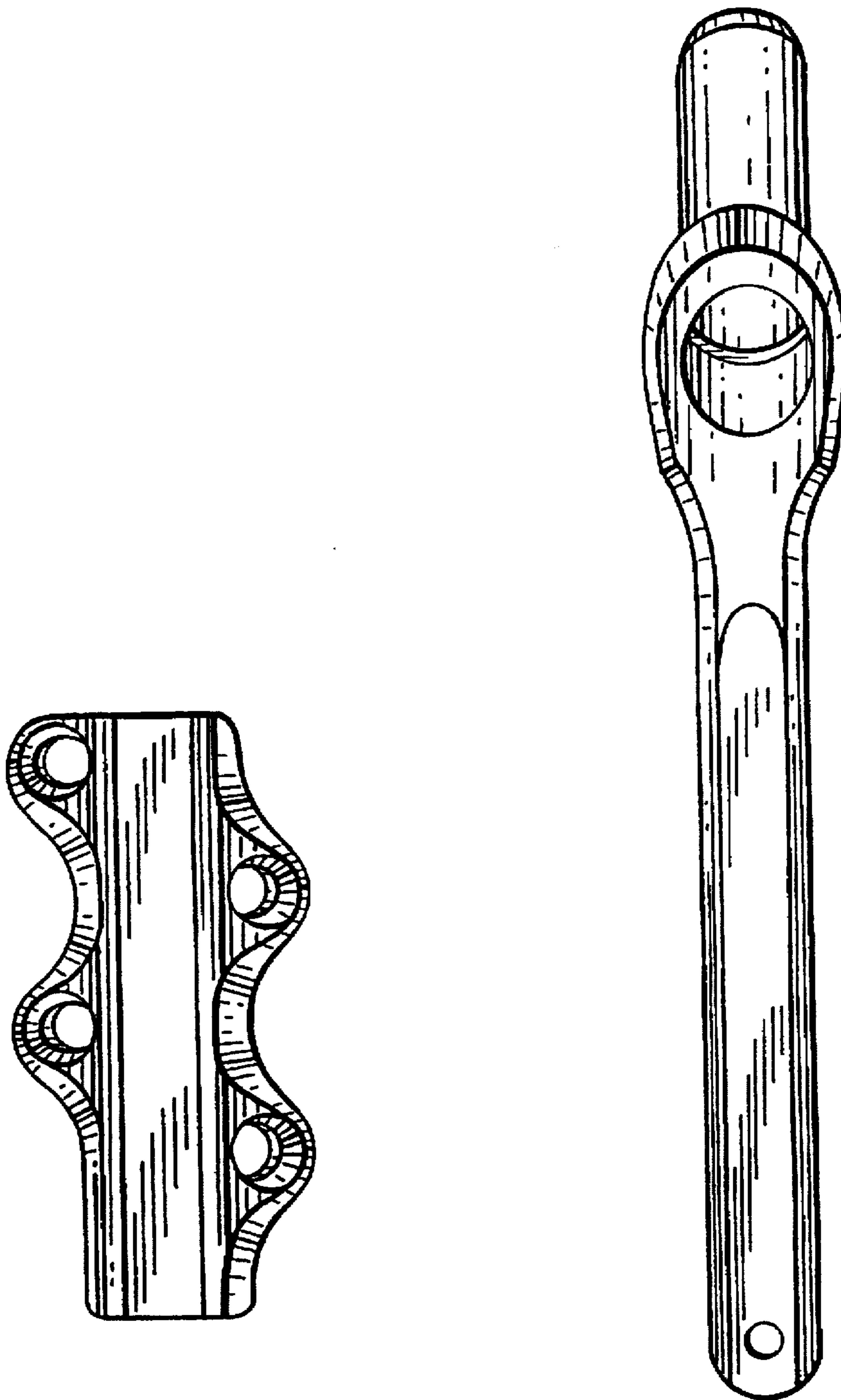

FIG. 8

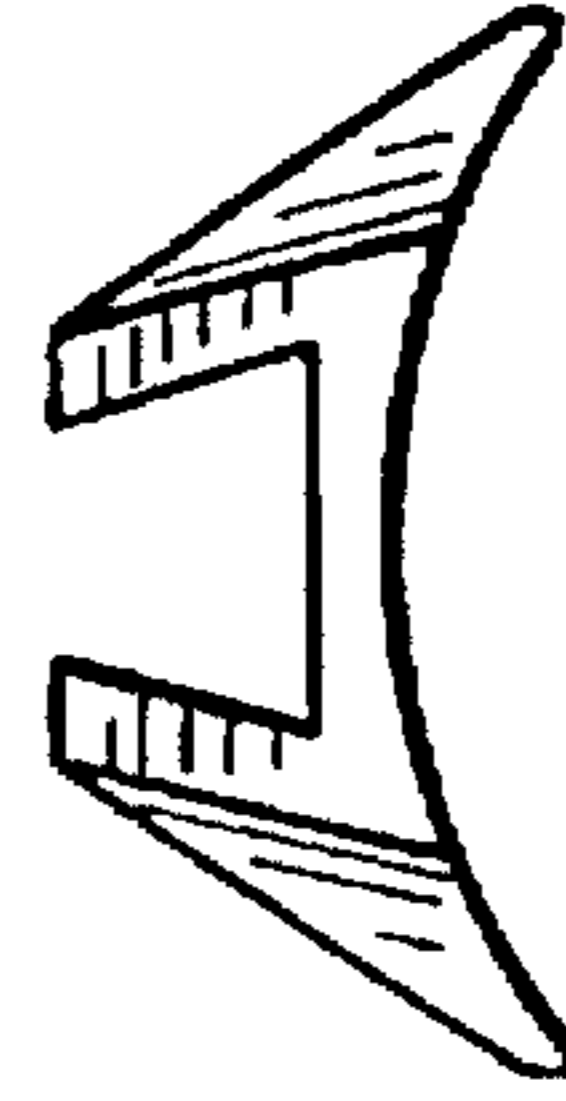
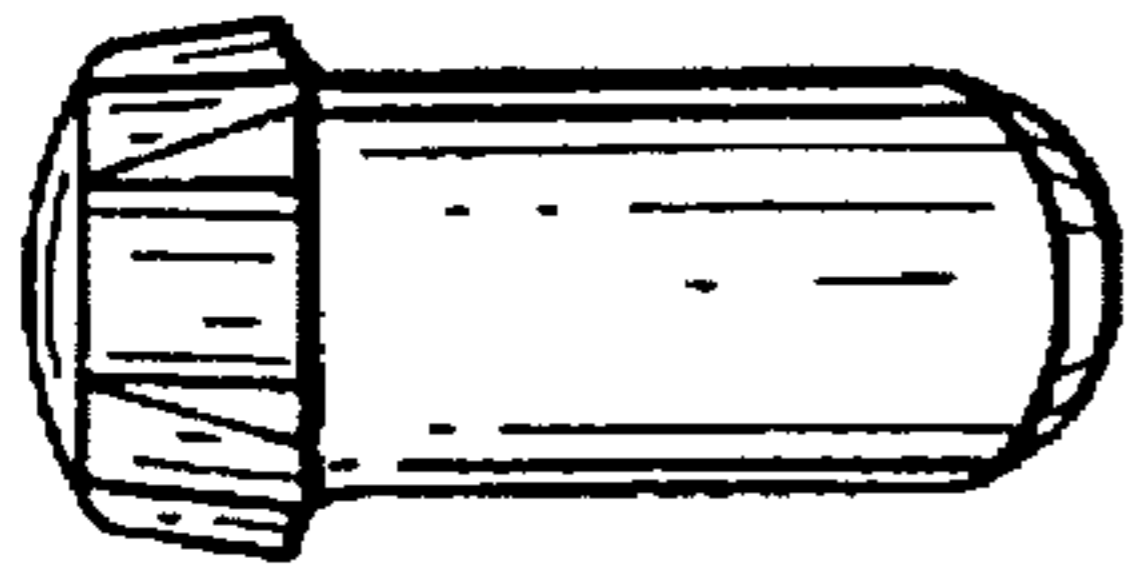

FIG. 10

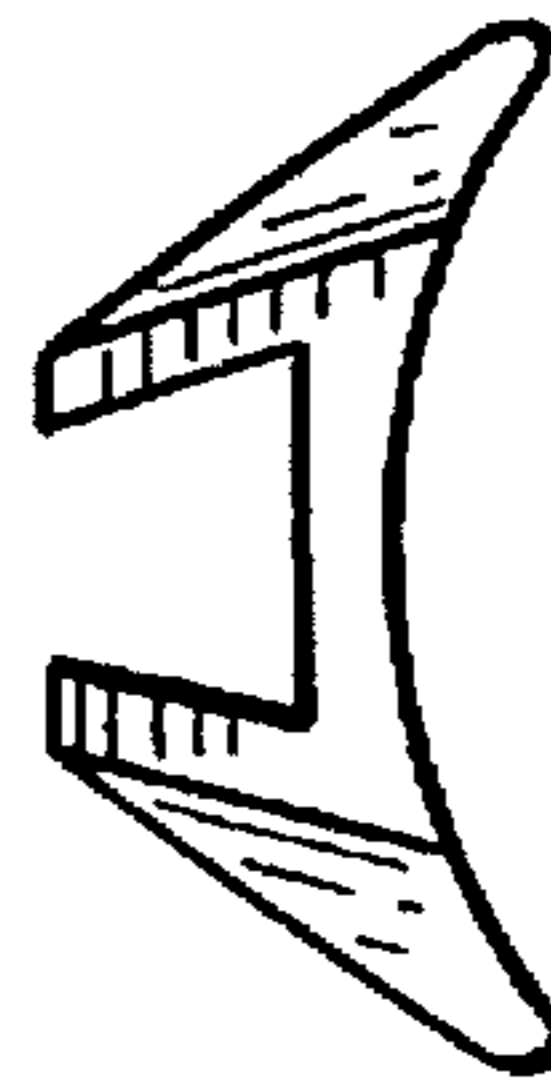
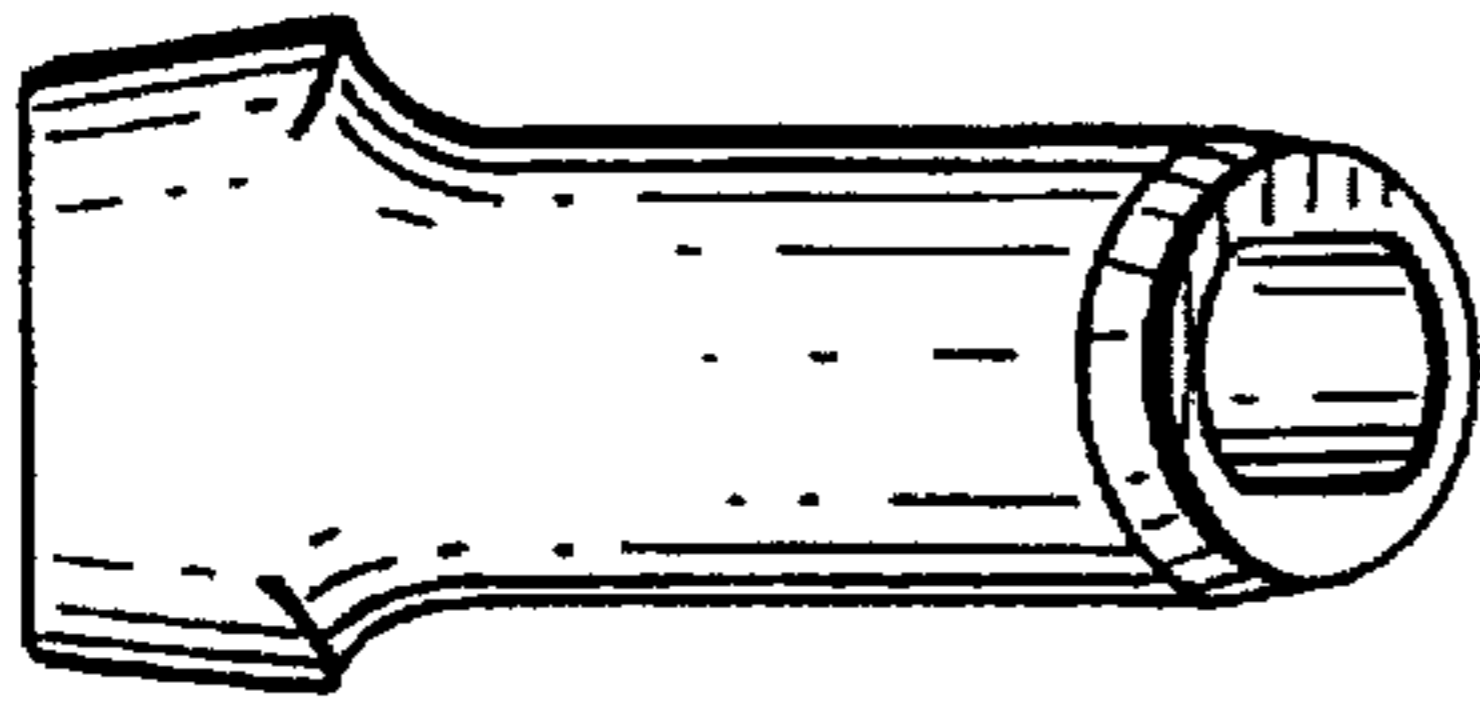
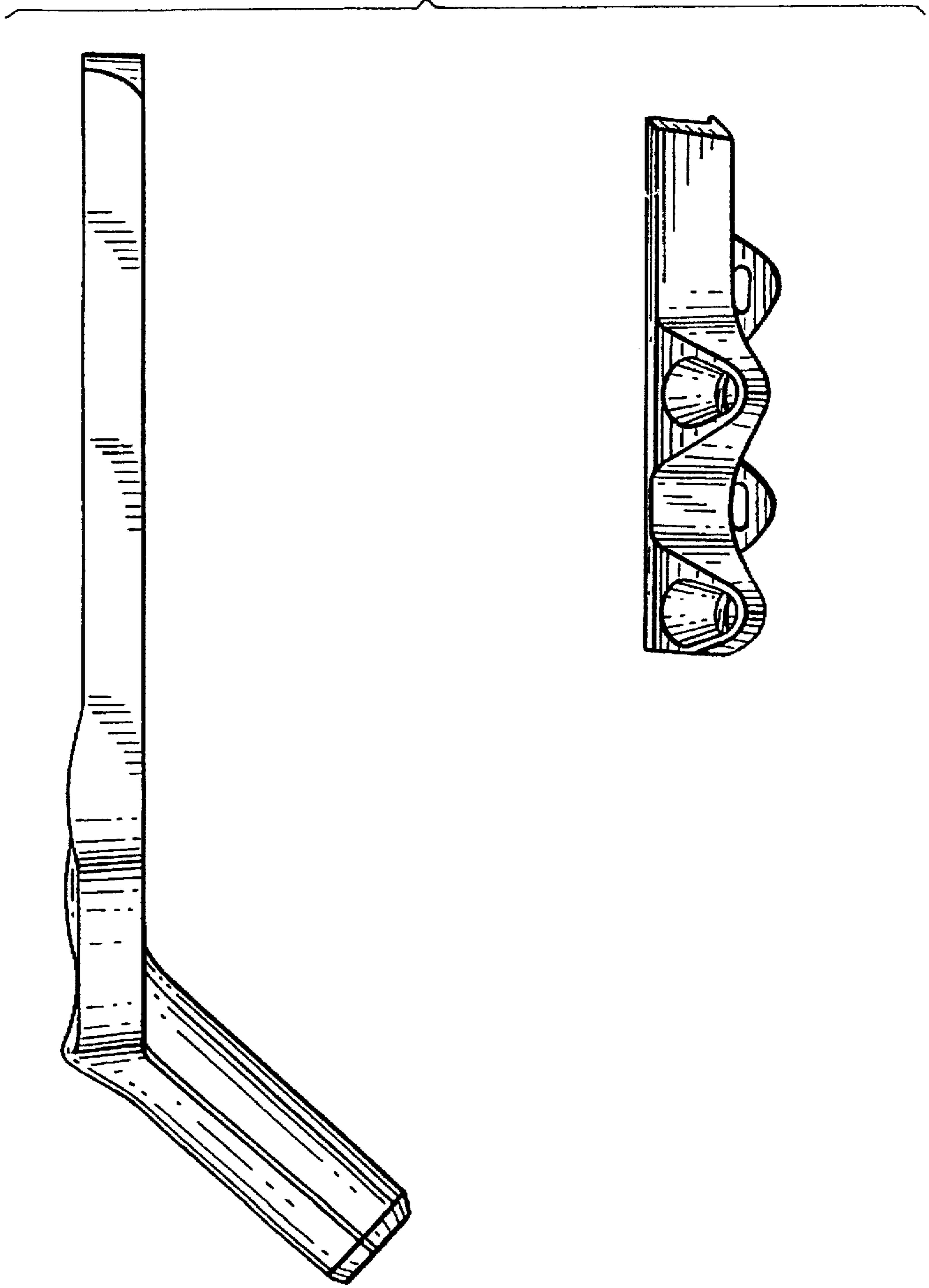

FIG. 9

FIG. 11



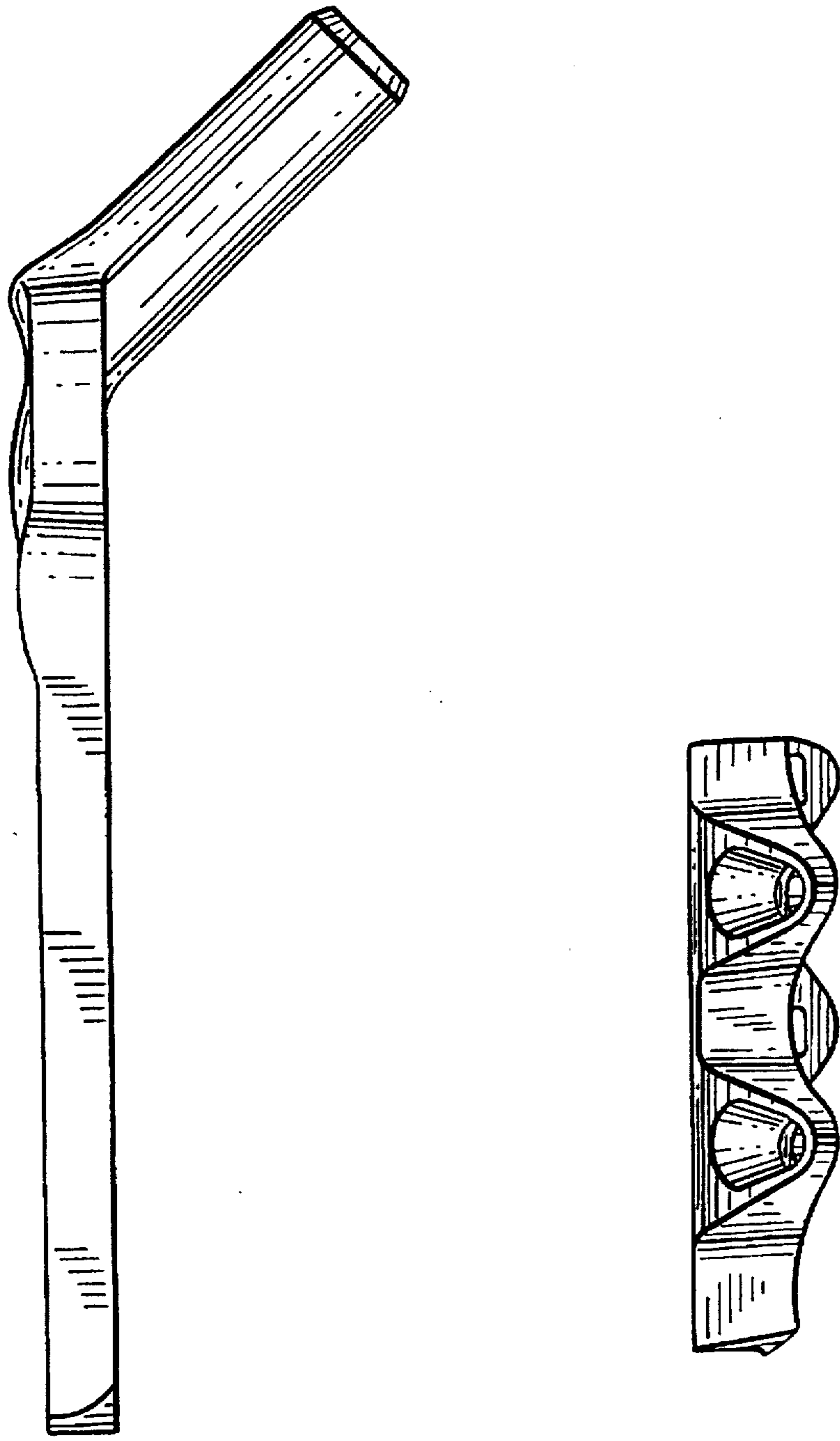

FIG. 12

FIG. 13

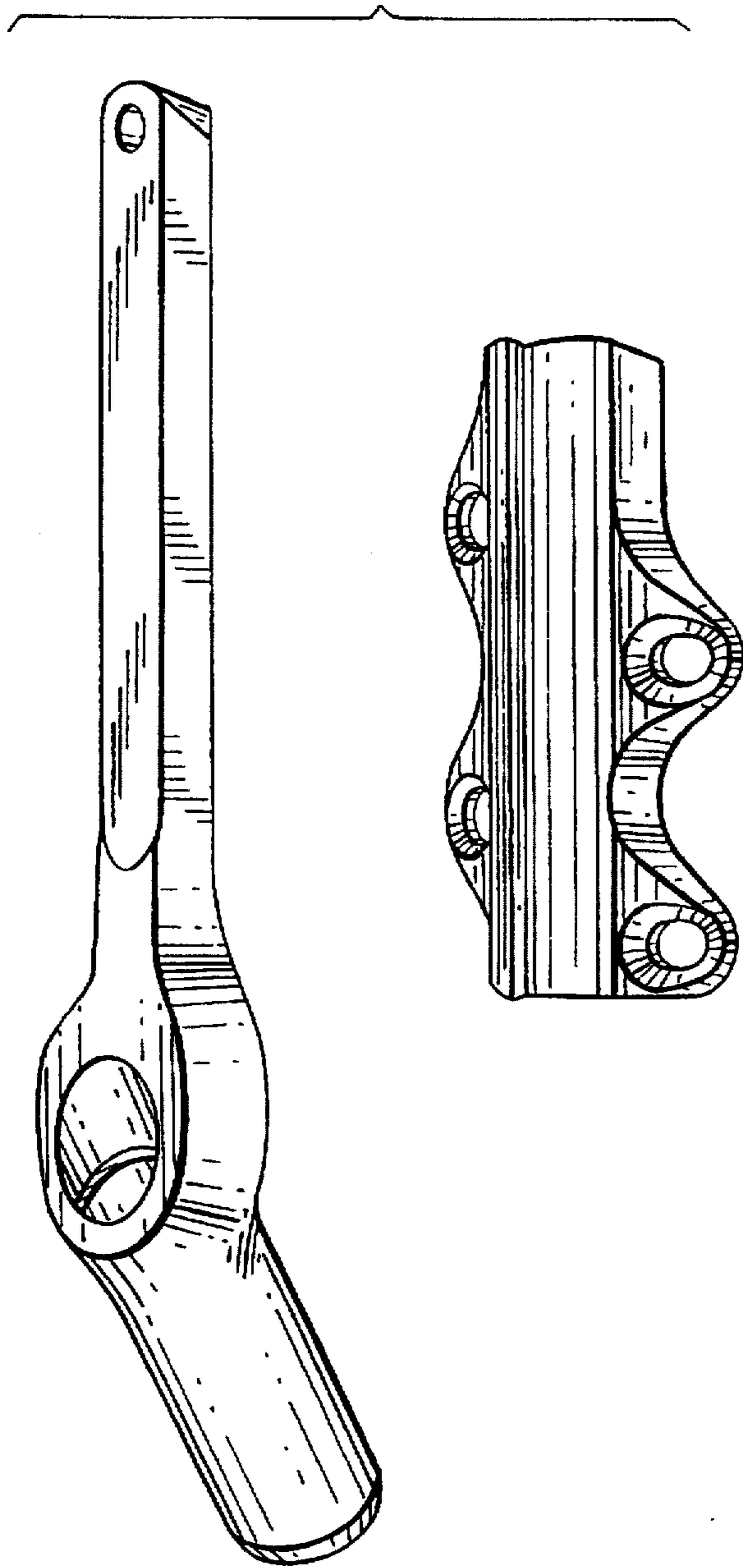
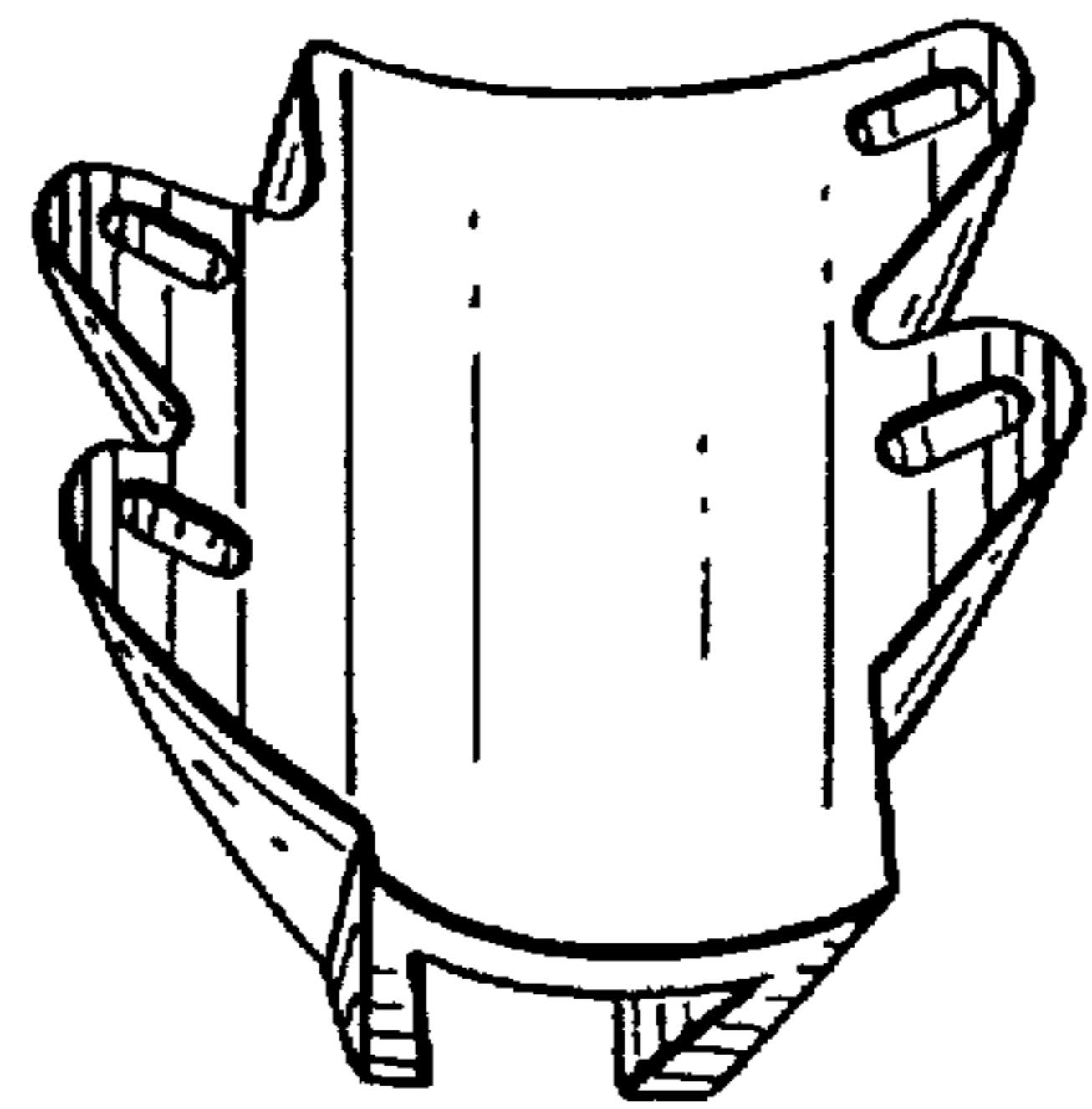

FIG. 14



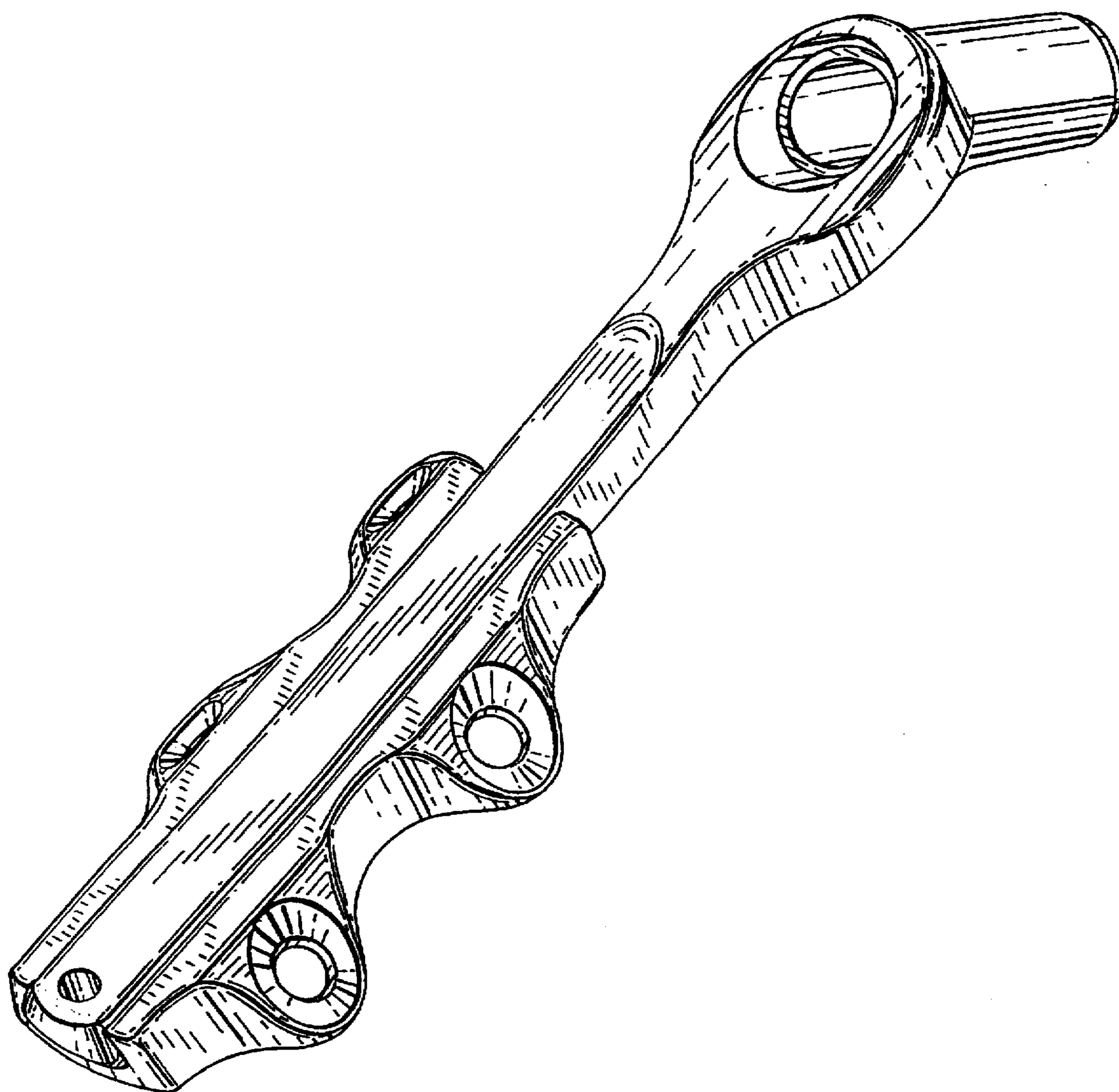

FIG. 15