

US00D385958S

United States Patent [19]

Higashino et al.

[11] Patent Number: **Des. 385,958**

[45] Date of Patent: ****Nov. 4, 1997**

[54] **BAFFLE PLATE OF AN OIL MIST FILTER**

[75] Inventors: **Toshihiro Higashino; Takashi Takato,**
both of Osaka, Japan

[73] Assignee: **Kuraco Limited,** Osaka, Japan

[**] Term: **14 Years**

[21] Appl. No.: **43,227**

[22] Filed: **Aug. 30, 1995**

[51] LOC (6) Cl. **23-04**

[52] U.S. Cl. **D23/365**

[58] Field of Search **D23/365, 209;**
34/166; 210/171; 165/159, 162, 131; 55/459.1;
96/189

[56] **References Cited**

U.S. PATENT DOCUMENTS

4,263,025 4/1981 Godare 96/189
5,227,077 7/1993 Shea 96/189 X

Primary Examiner—Holly Baynham

Attorney, Agent, or Firm—Nikaido, Marmelstein, Murray & Oram LLP

[57] **CLAIM**

The ornamental design for a baffle plate of an oil mist filter, as shown and described.

DESCRIPTION

FIG. 1 is a front view of the baffle plate showing our new design;

FIG. 2 is a rear view of the baffle plate;

FIG. 3 is a left-hand side view of the baffle plate;

FIG. 4 is a right-hand side view thereof;

FIG. 5 is a top plan view with the bottom plan view being a mirror image; and,

FIG. 6 is a reduced, environmental perspective view thereof with a broken line showing of an oil mist filter being for illustrative purposes only and forming no part of the claimed design.

The baffle plate is shown broken away in FIGS. 1-4 for ease of illustration.

1 Claim, 3 Drawing Sheets

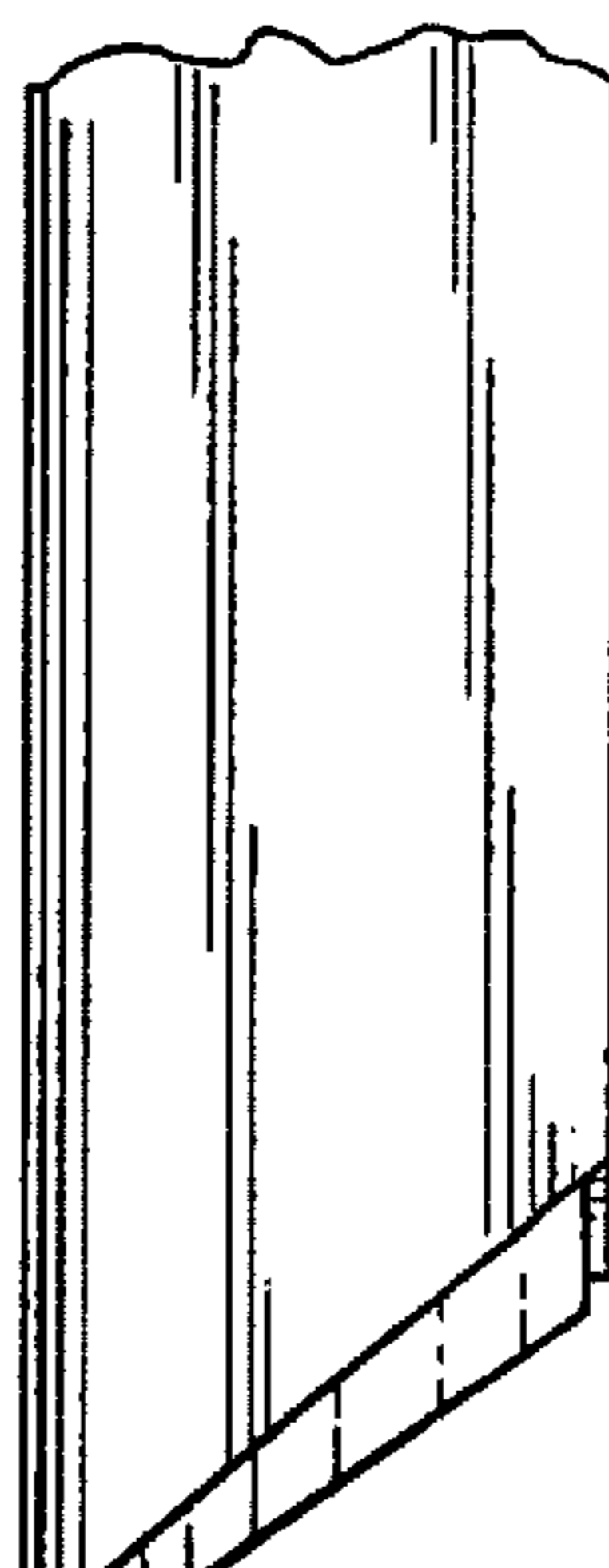
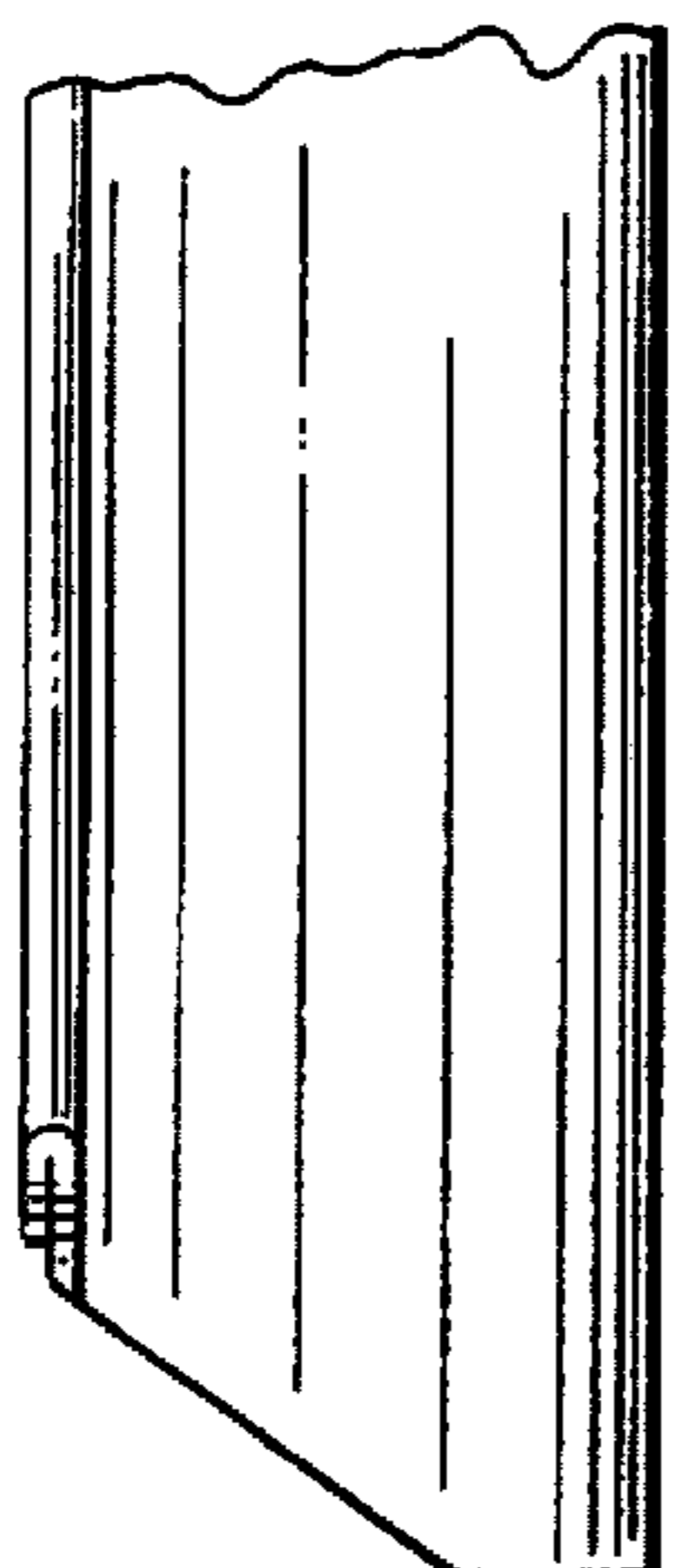
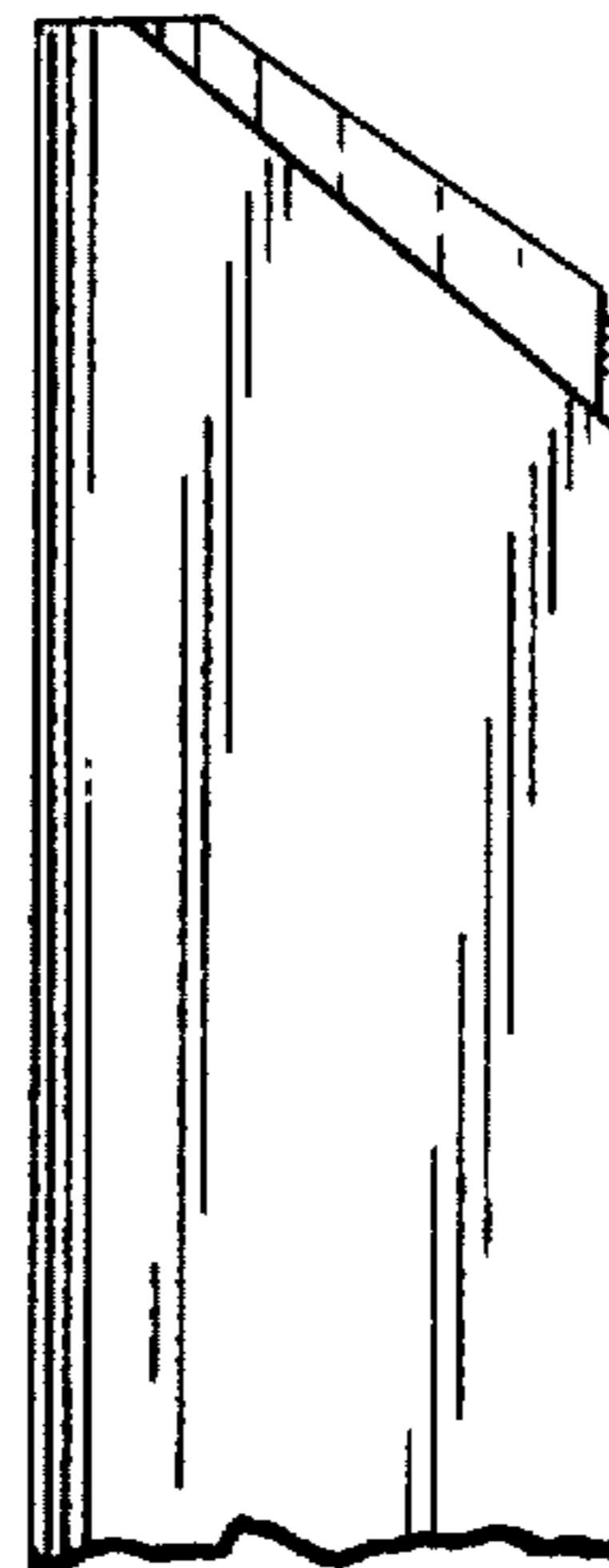
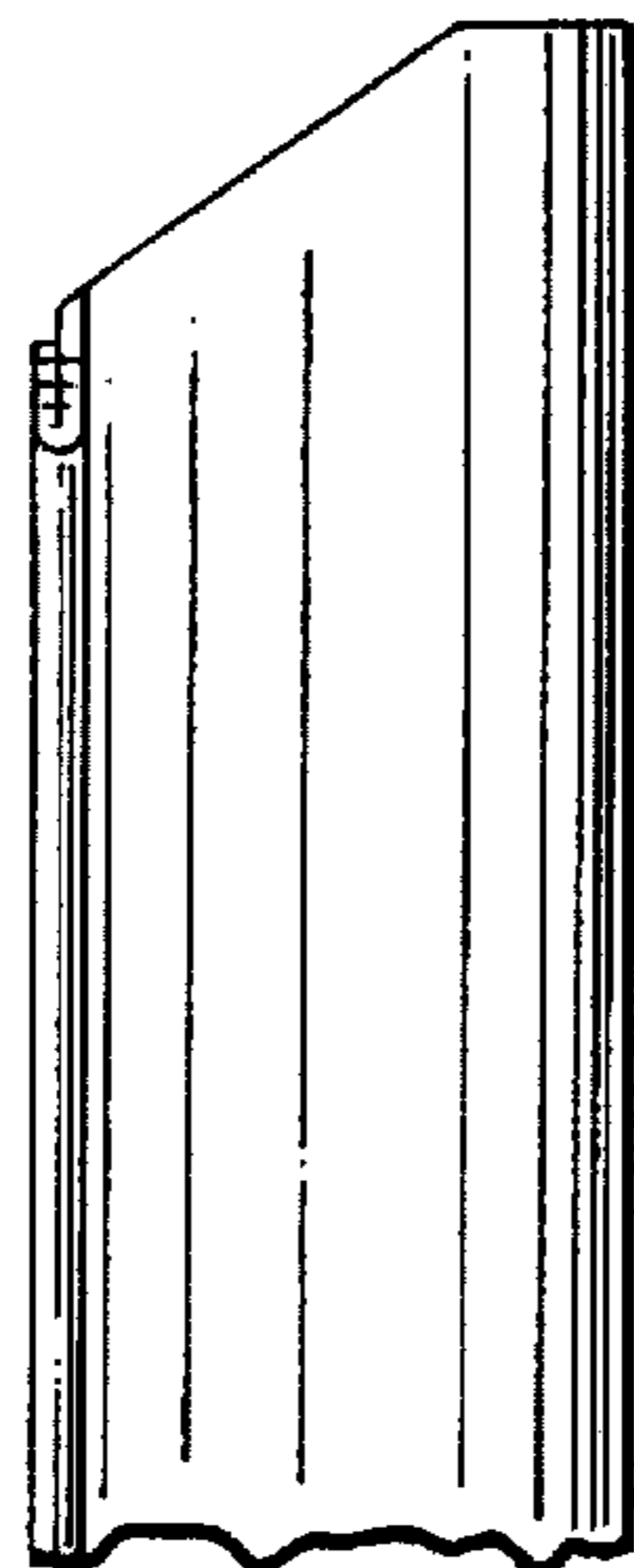

FIG. 1

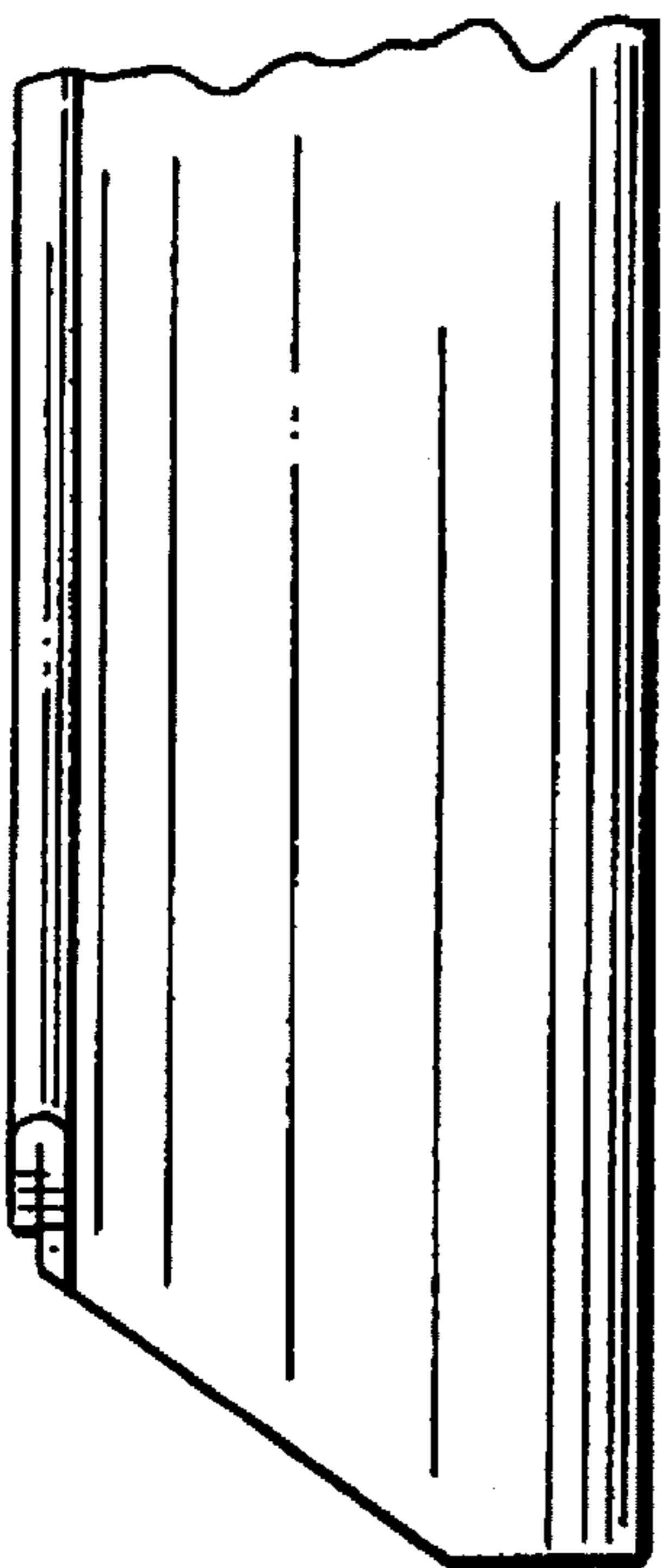
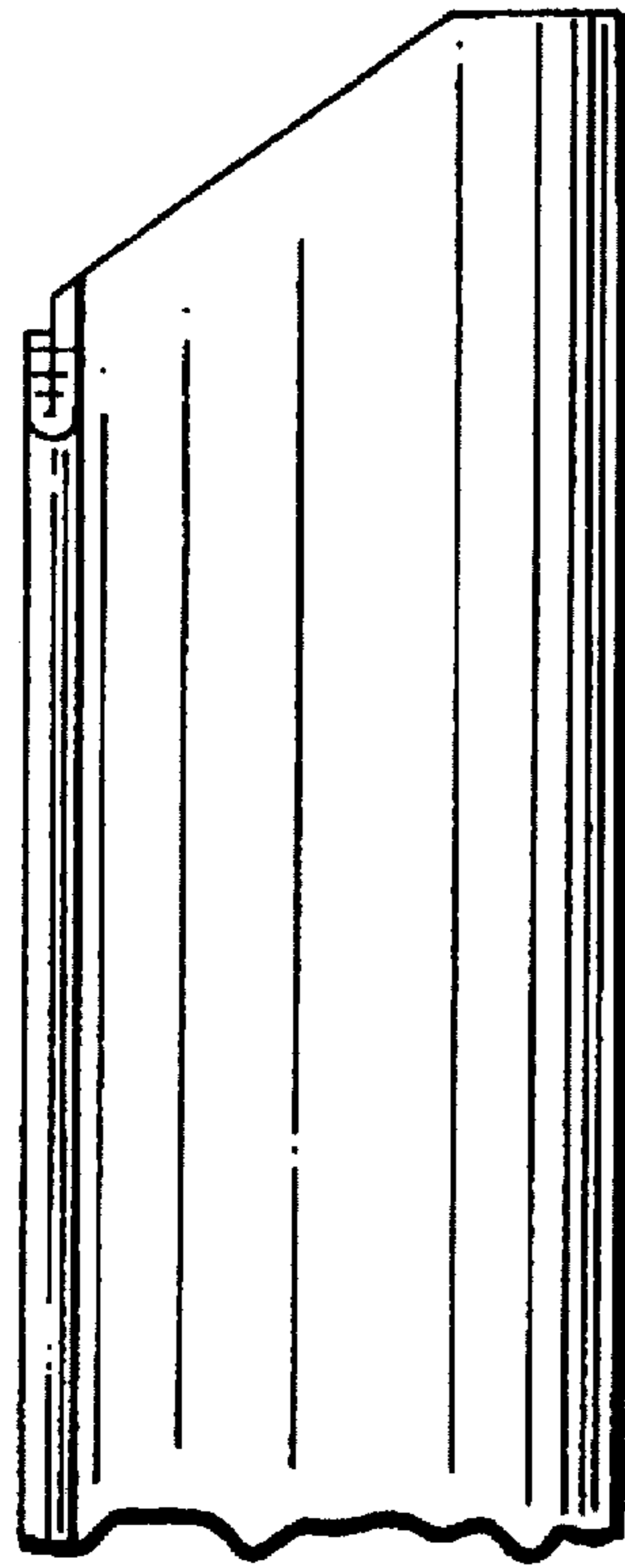

FIG. 2

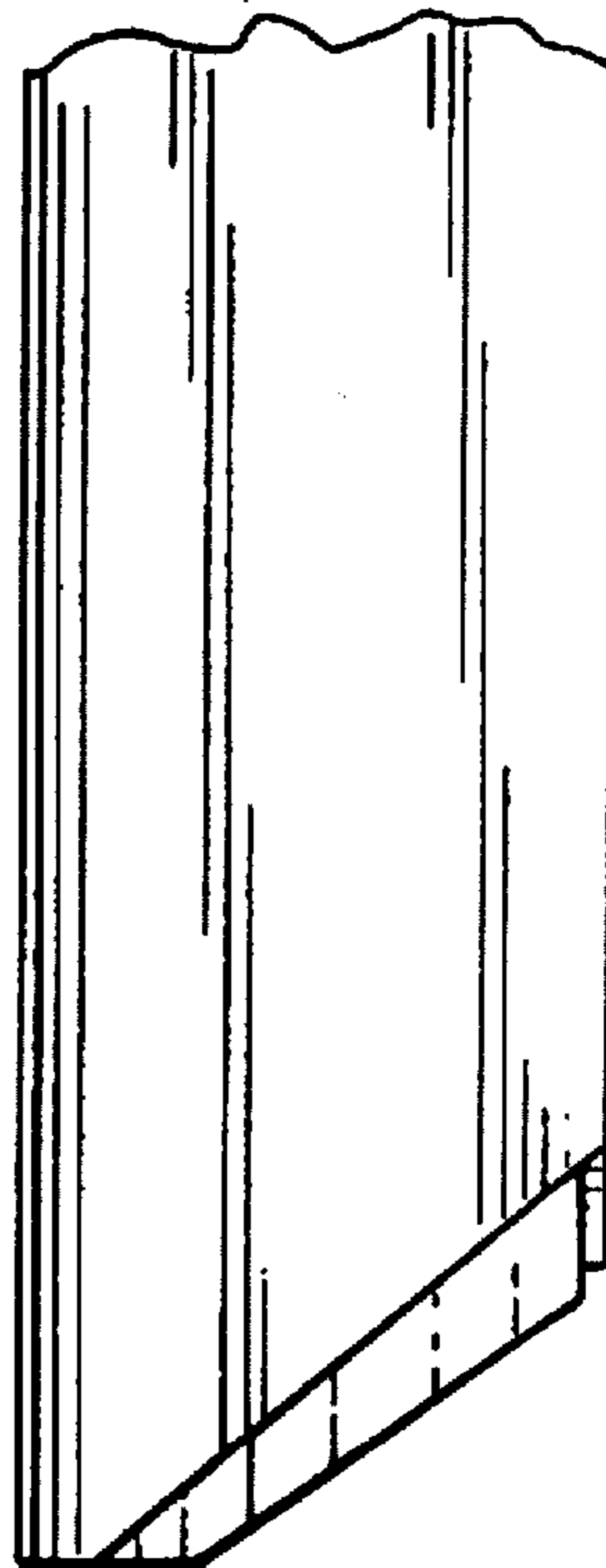
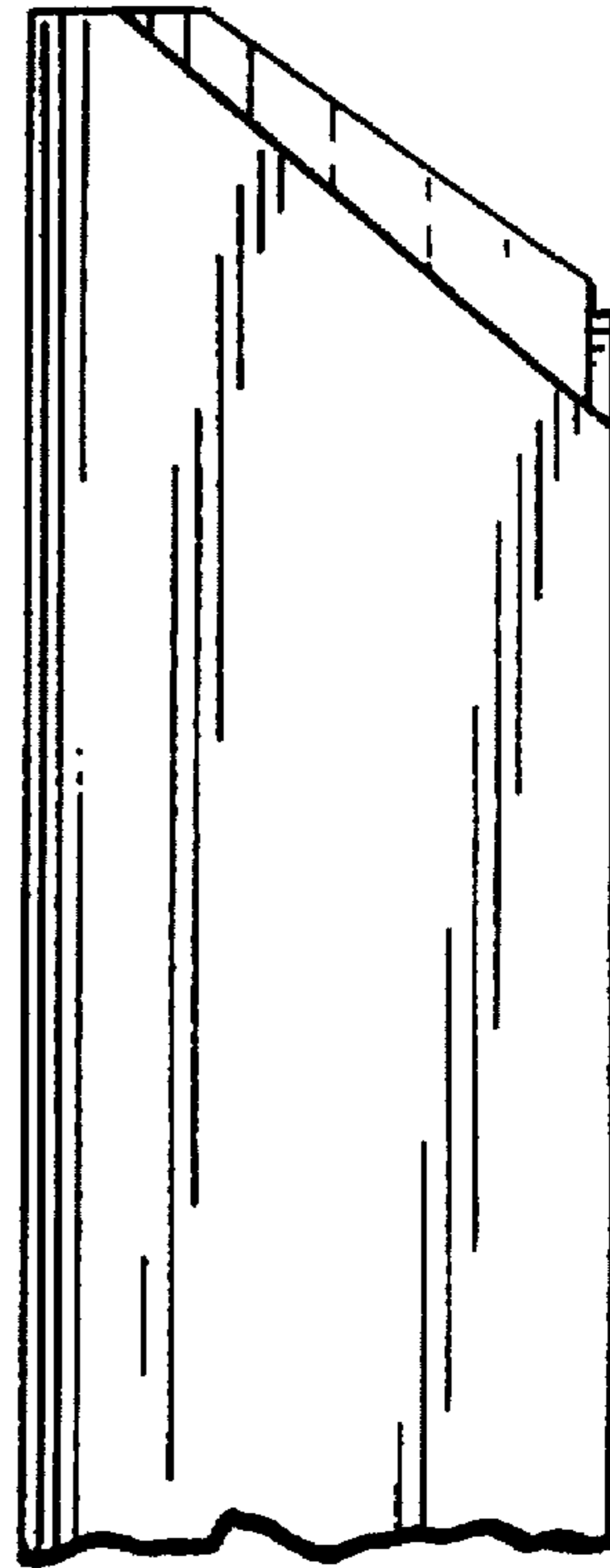

FIG. 3

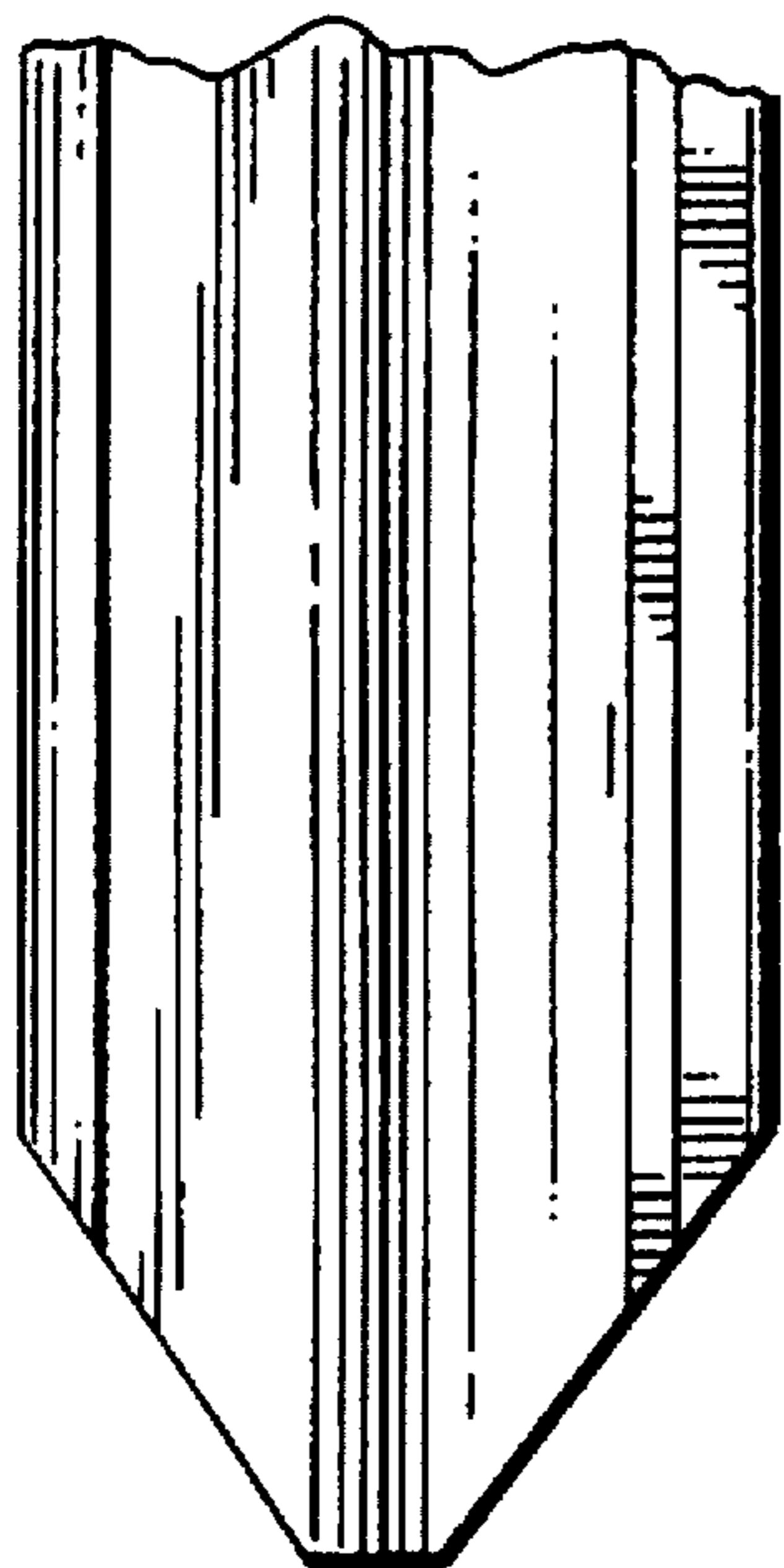
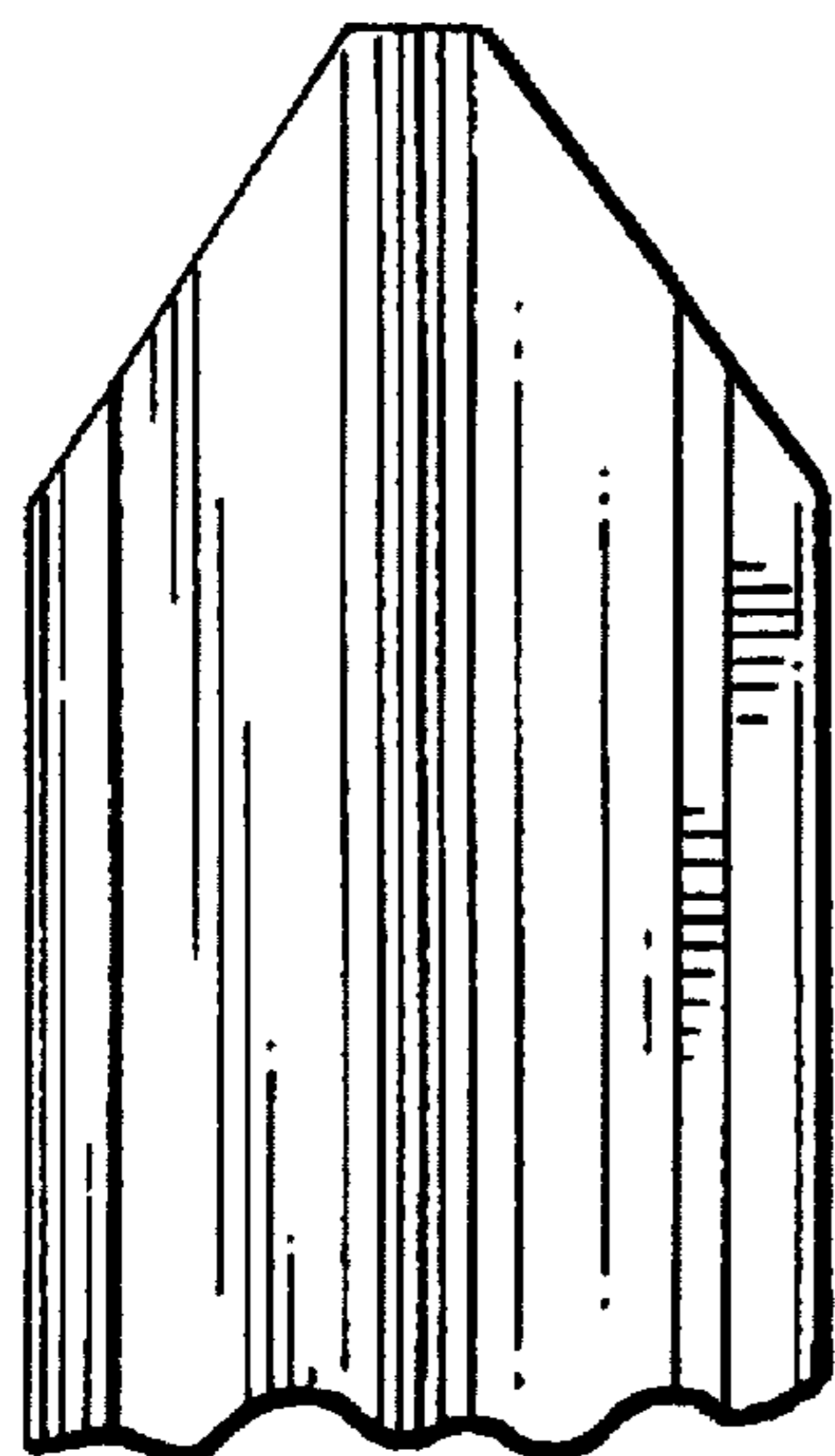

FIG. 4

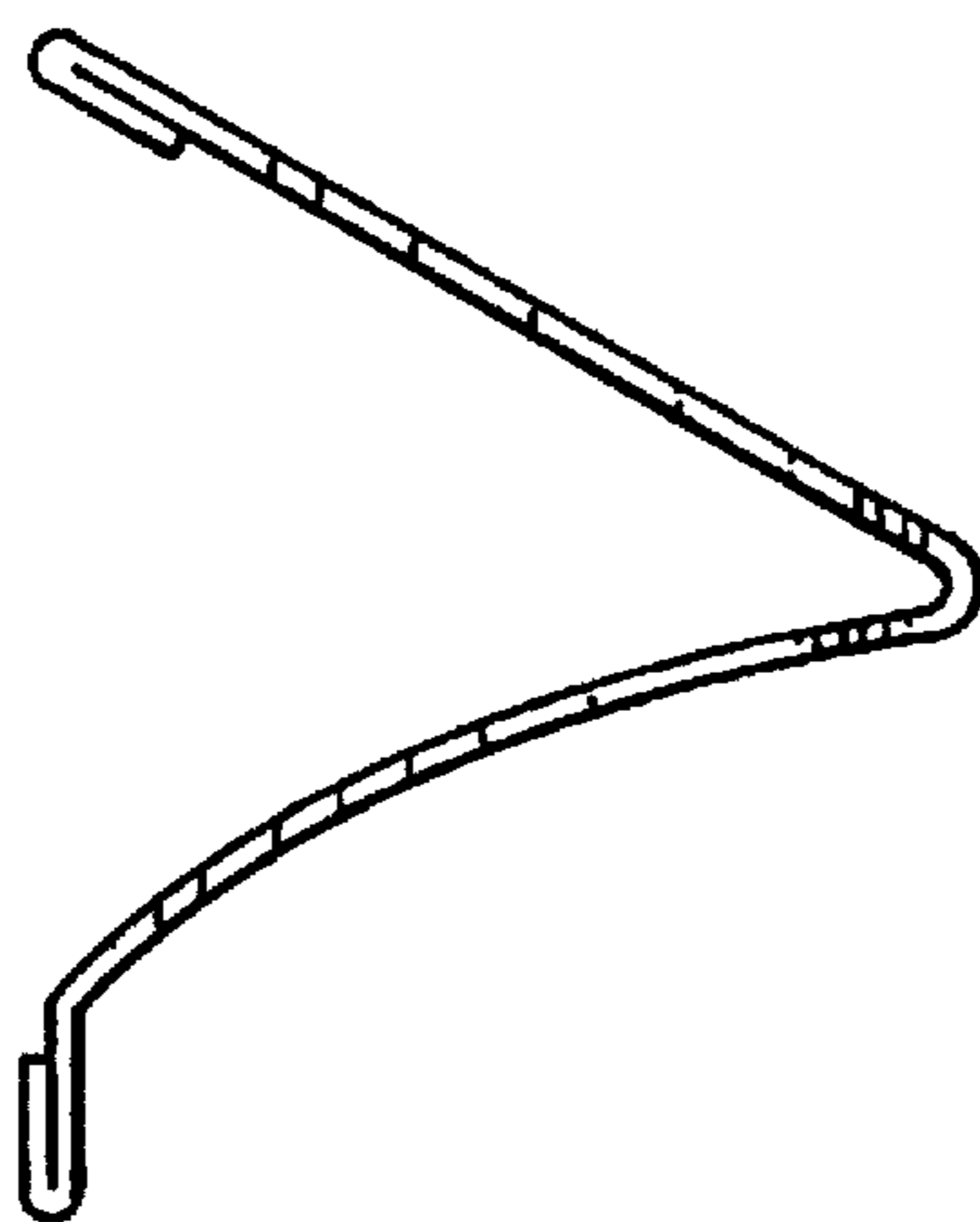
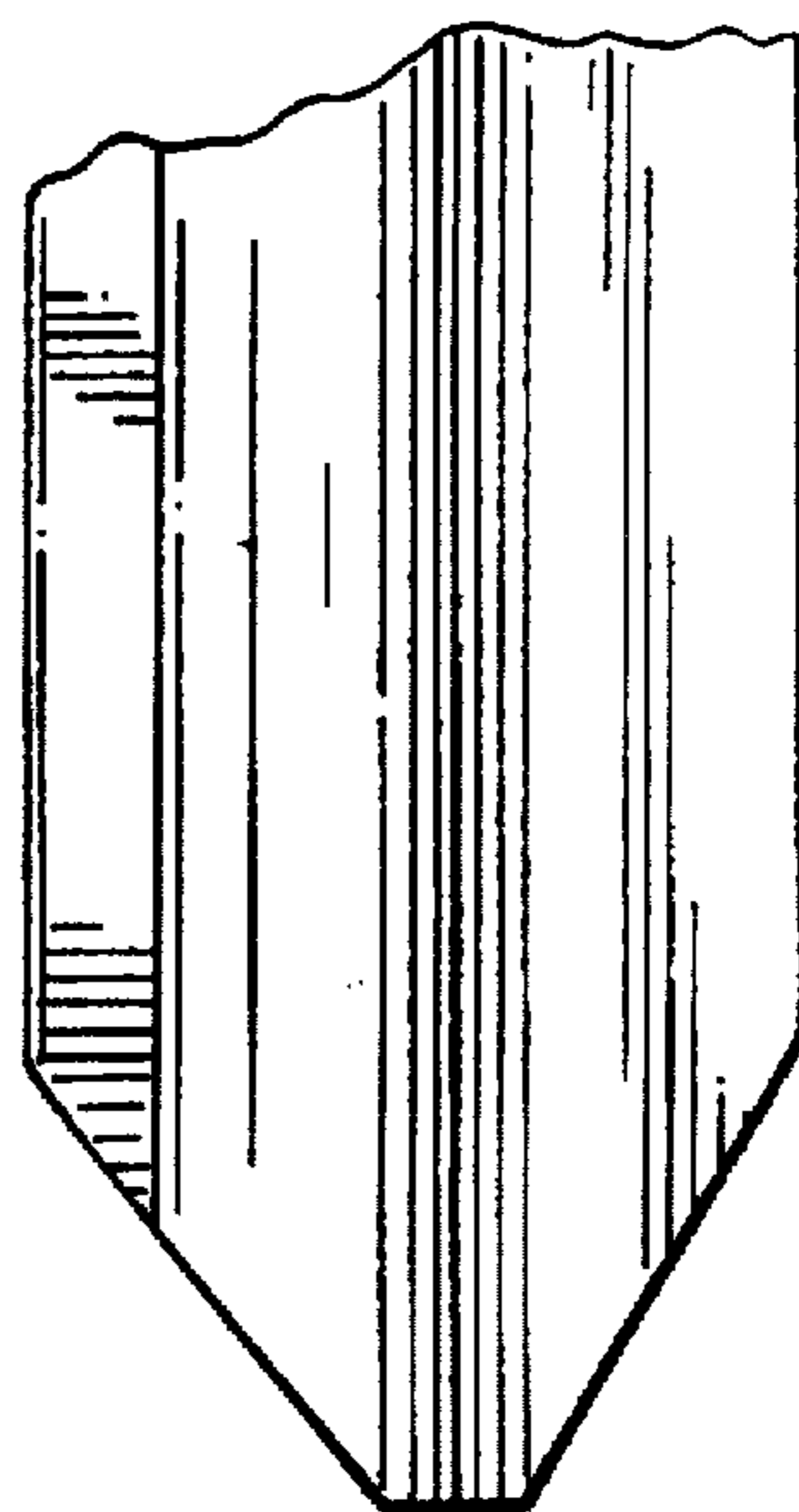
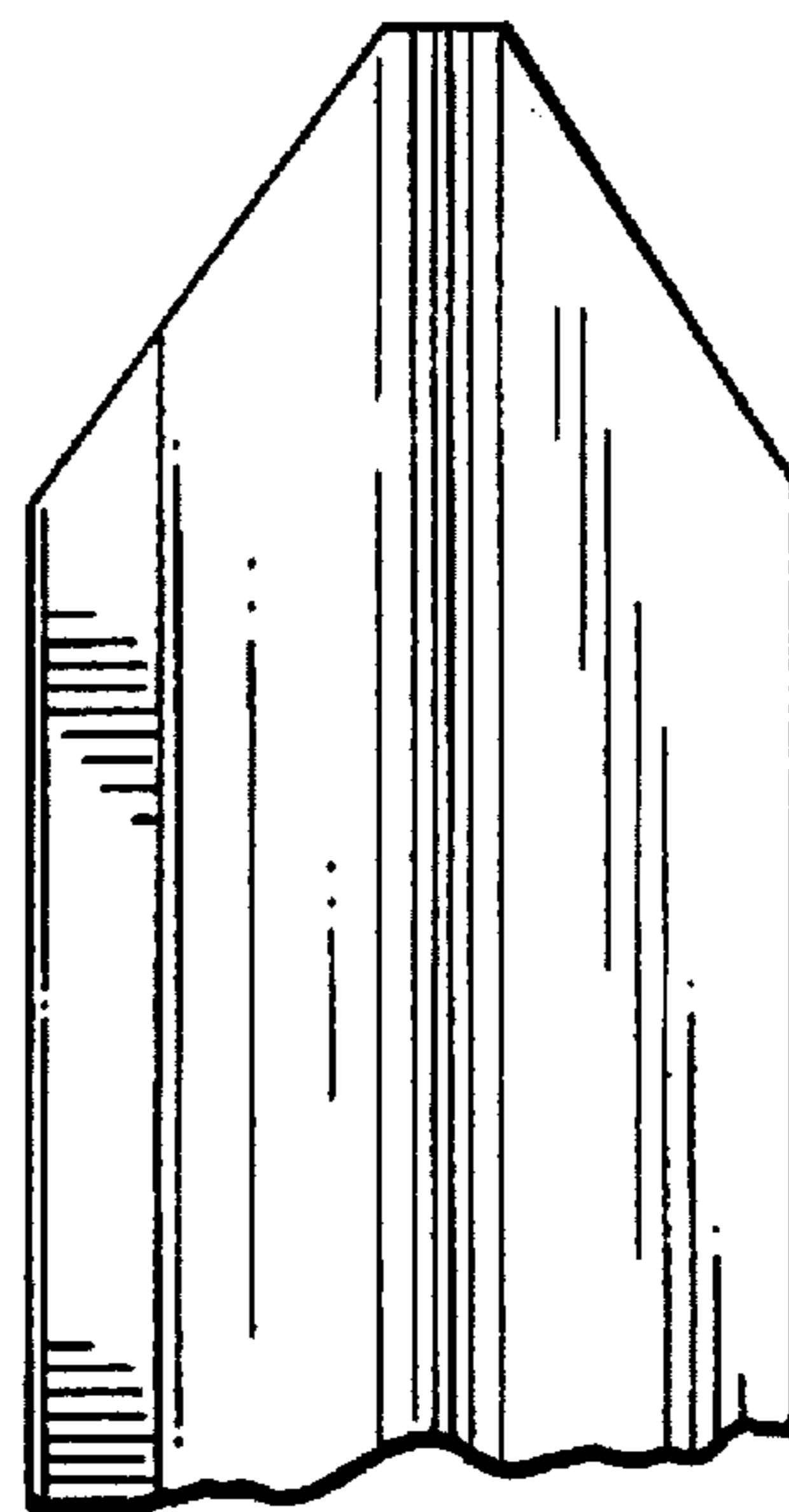

FIG. 5

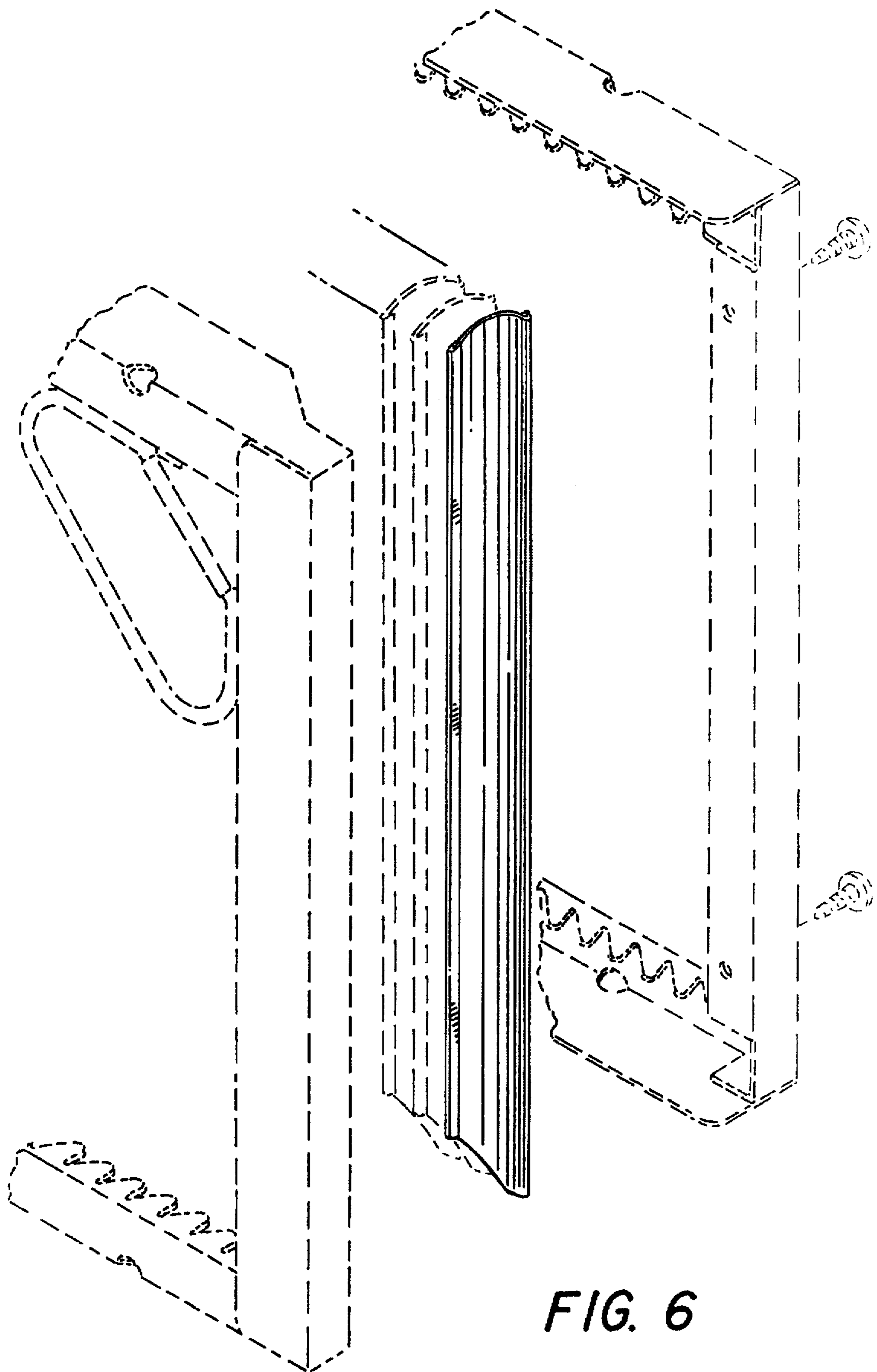

FIG. 6