



US00D385955S

United States Patent [19]

Hundley et al.

[11] Patent Number: **Des. 385,955**

[45] Date of Patent: ****Nov. 4, 1997**

[54] **HANDLE FOR A PLUMBING FITTING**

[75] Inventors: **Jill E. Hundley; Mary J. Reid**, both of Sheboygan, Wis.

[73] Assignee: **Kohler Co.**, Kohler, Wis.

[**] Term: **14 Years**

[21] Appl. No.: **49,421**

[22] Filed: **Jan. 24, 1996**

[51] LOC (6) Cl. **23-01**

[52] U.S. Cl. **D23/212**

[58] Field of Search **D23/241-243, D23/250-254; D8/300, 303, 306, 307, 308, 338; 16/117, 118, 119, 121, 126**

[56] **References Cited**

U.S. PATENT DOCUMENTS

D. 271,561	11/1983	Valli	D8/308
D. 300,719	4/1989	Rhoades et al.	D8/308
D. 345,901	4/1994	Poitasek et al.	D8/308
D. 348,509	7/1994	Bollenbacher	D6/550
D. 355,578	2/1995	Mark et al.	D8/308

OTHER PUBLICATIONS

Undated photo of a corkscrew, admitted prior art.
Undated Harden catalog ad, p. 25, showing a "56 Series" faucet handle escutcheon, admitted prior art.
1989 WICO catalog ad showing "Retro" faucet handle escutcheon.

Primary Examiner—Stella Reid

Assistant Examiner—Eric Watterson
Attorney, Agent, or Firm—Quarles & Brady

[57] **CLAIM**

The ornamental design for a handle for a plumbing fitting, as shown and described.

DESCRIPTION

FIG. 1 is a right, top, front perspective view of embodying our new design;
FIG. 2 is a front elevational view thereof;
FIG. 3 is a rear elevational view thereof;
FIG. 4 is a left side elevational view thereof;
FIG. 5 is a right side elevational view thereof;
FIG. 6 is a top plan view thereof;
FIG. 7 is a left, top, front perspective view of a second embodiment which is essentially identical to the first embodiment but for the clock-wise screw of the handle;
FIG. 8 is a left side elevational view thereof;
FIG. 9 is a top plan view thereof;
FIG. 10 is a right, top, front perspective view of a third embodiment;
FIG. 11 is a front elevational view thereof;
FIG. 12 is a rear elevational view thereof;
FIG. 13 is a left side elevational view thereof;
FIG. 14 is a right side elevational view thereof;
FIG. 15 is a top plan view thereof;
FIG. 16 is a left, top, front perspective view of a fourth embodiment which is essentially identical to the third embodiment but for the clock-wise screw of the handle;
FIG. 17 is a left side elevational view thereof; and,
FIG. 18 is a top plan view thereof.

1 Claim, 6 Drawing Sheets

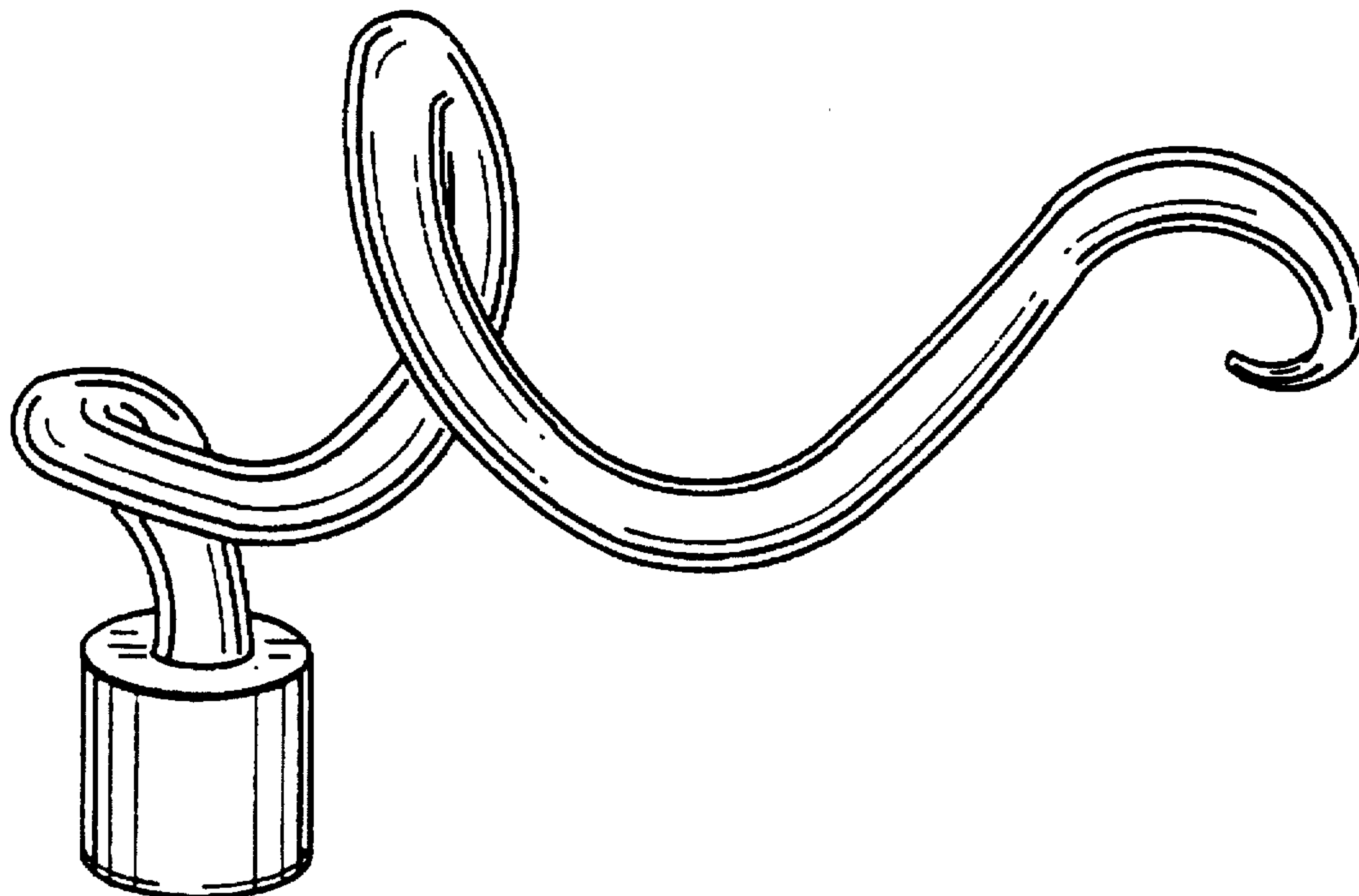

FIG. 1

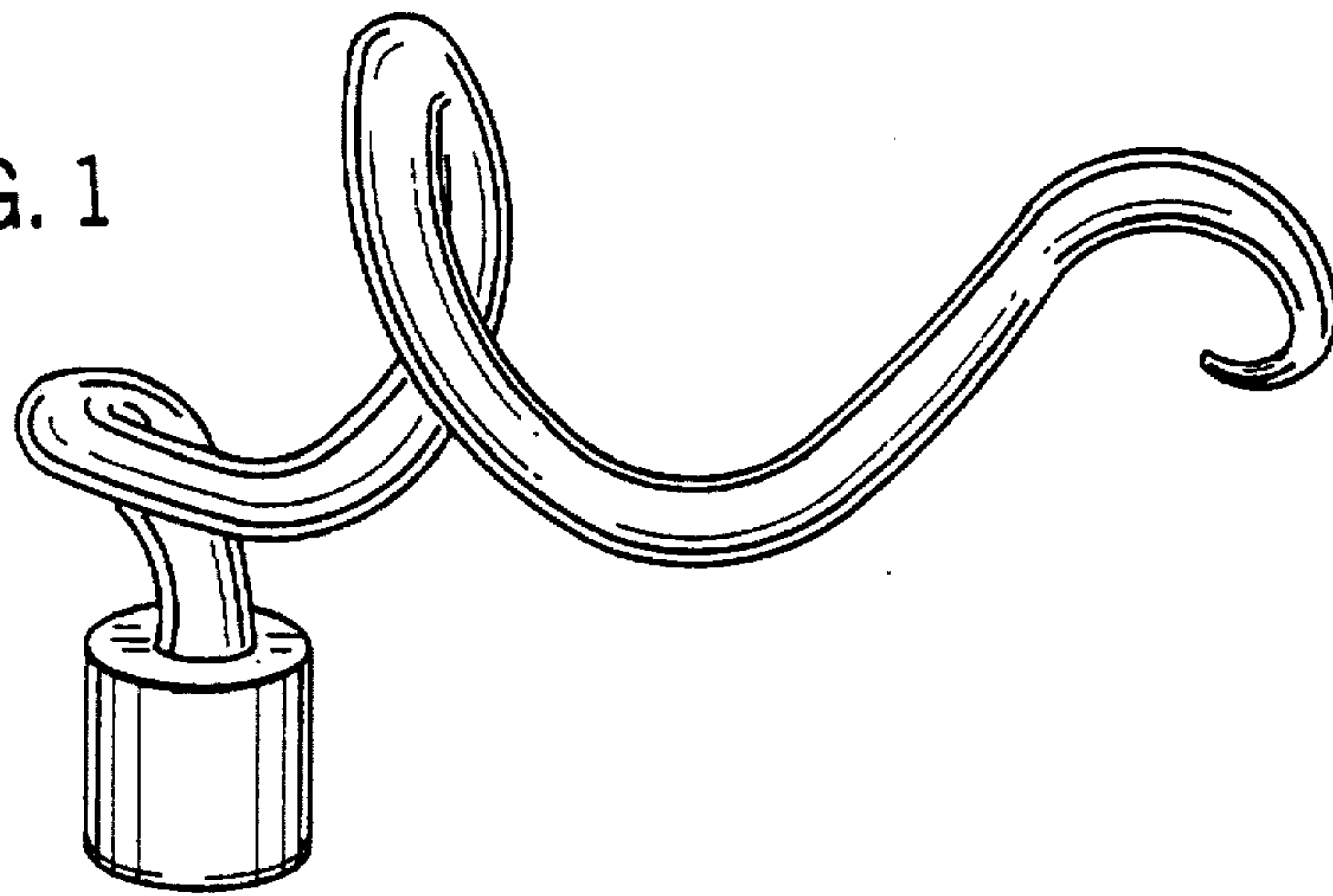

FIG. 2

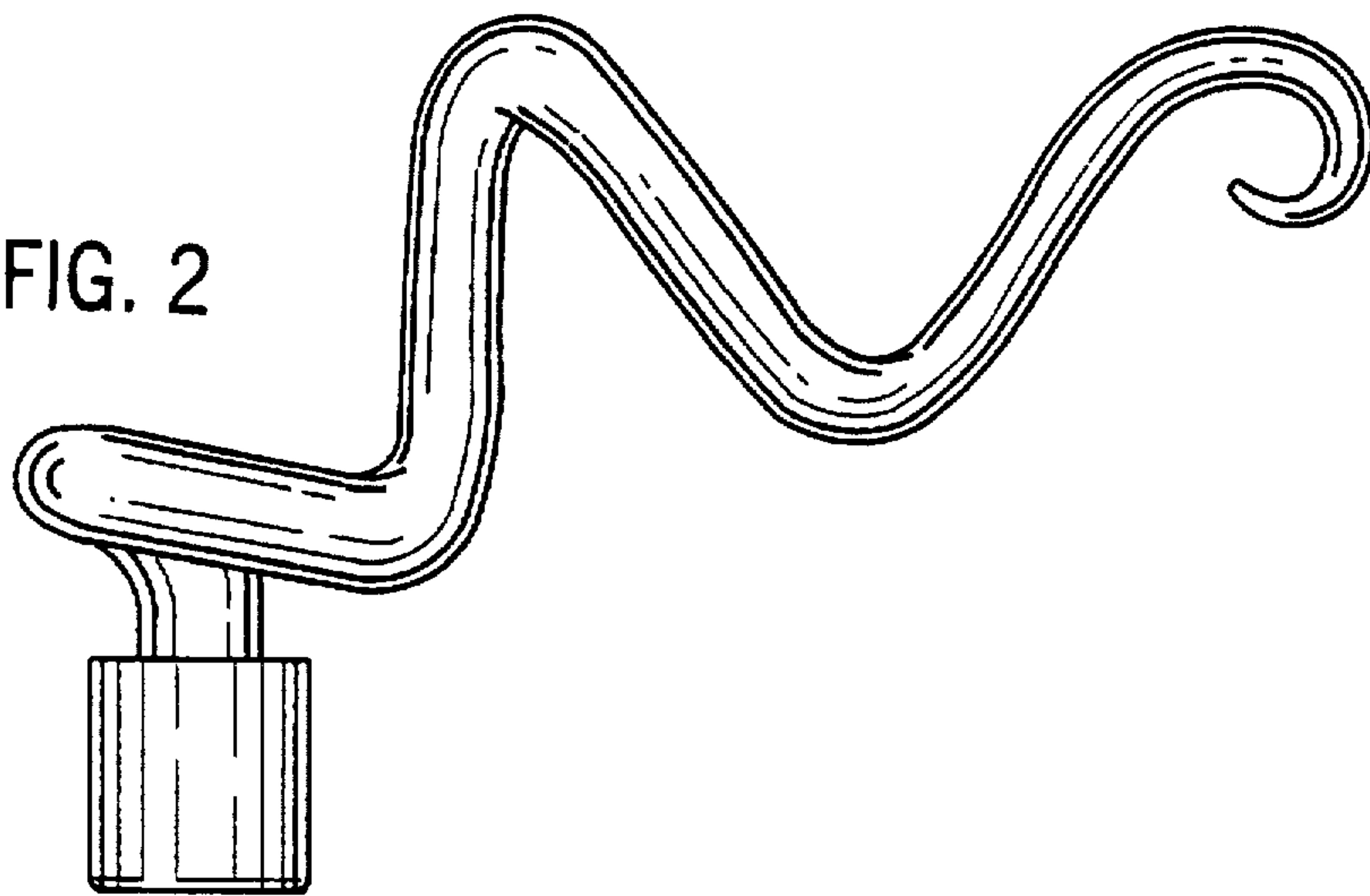

FIG. 3

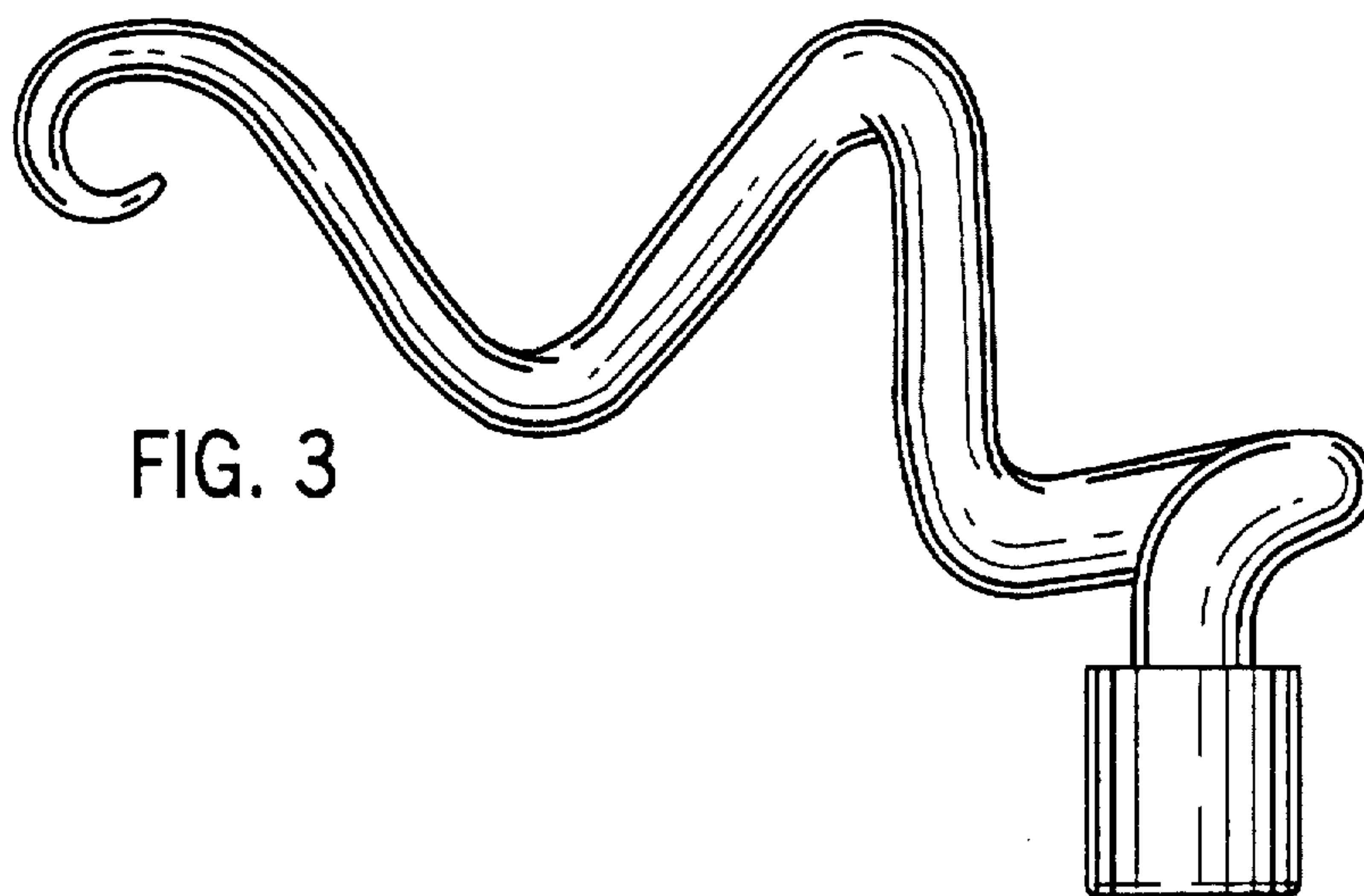

FIG. 4

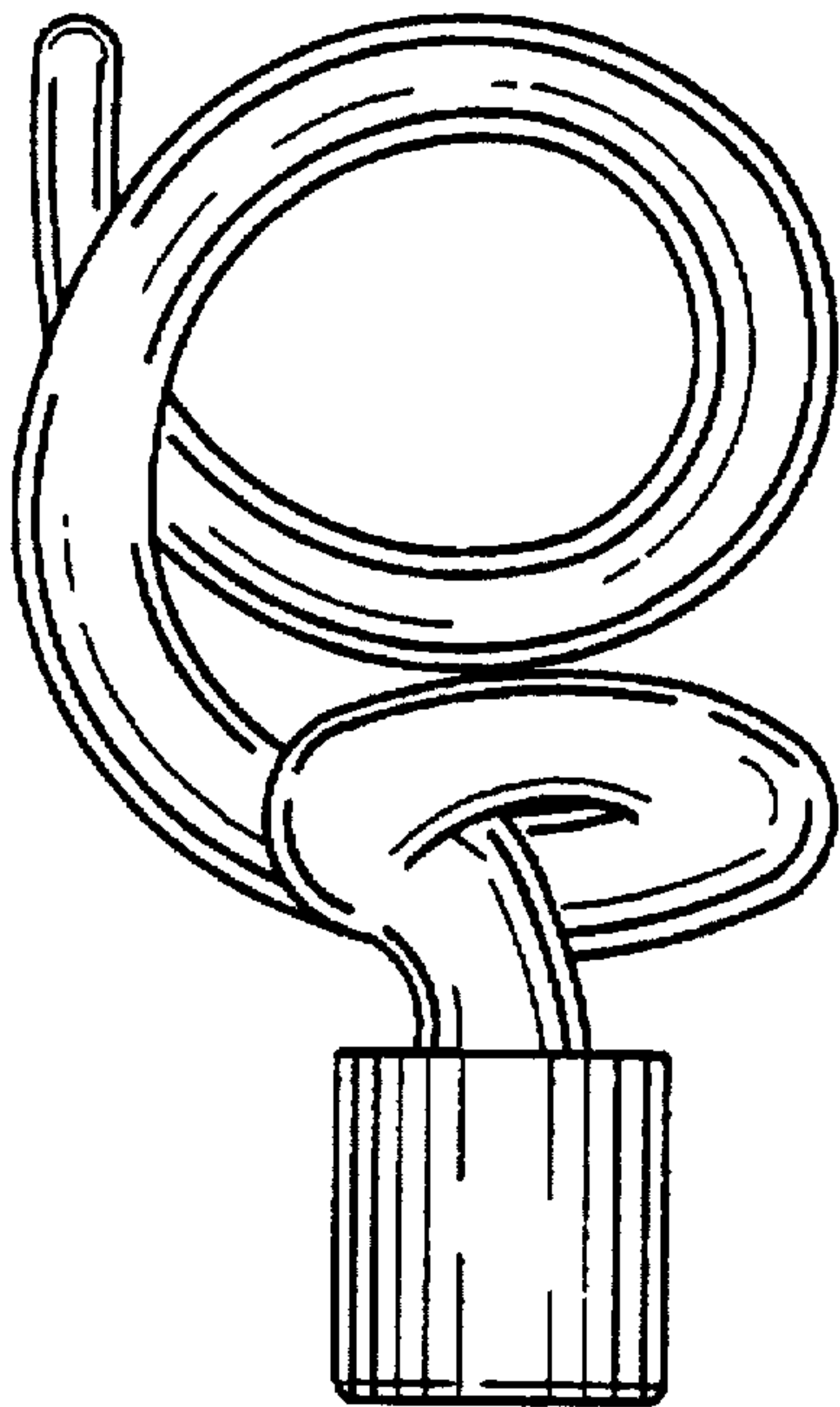

FIG. 5

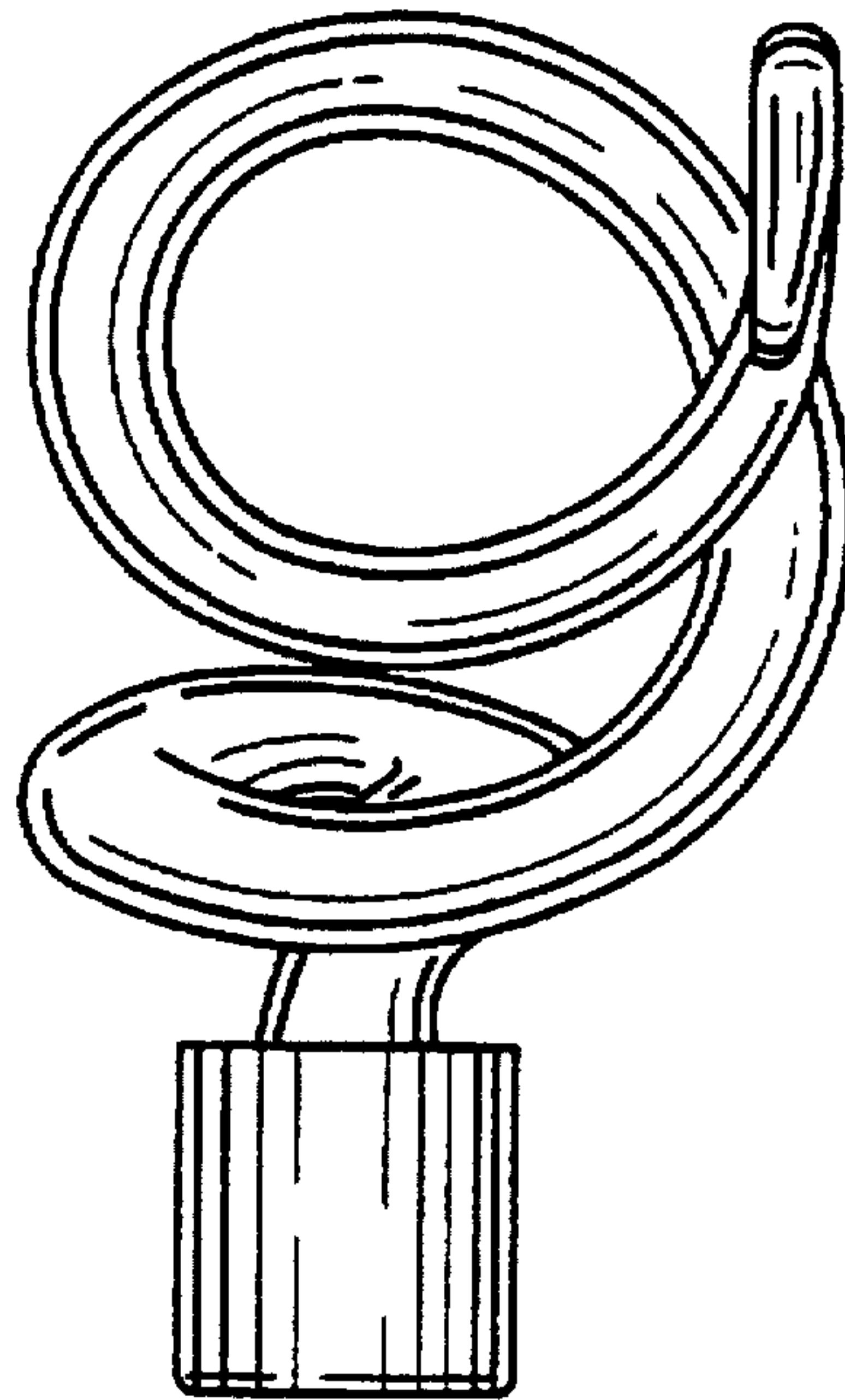
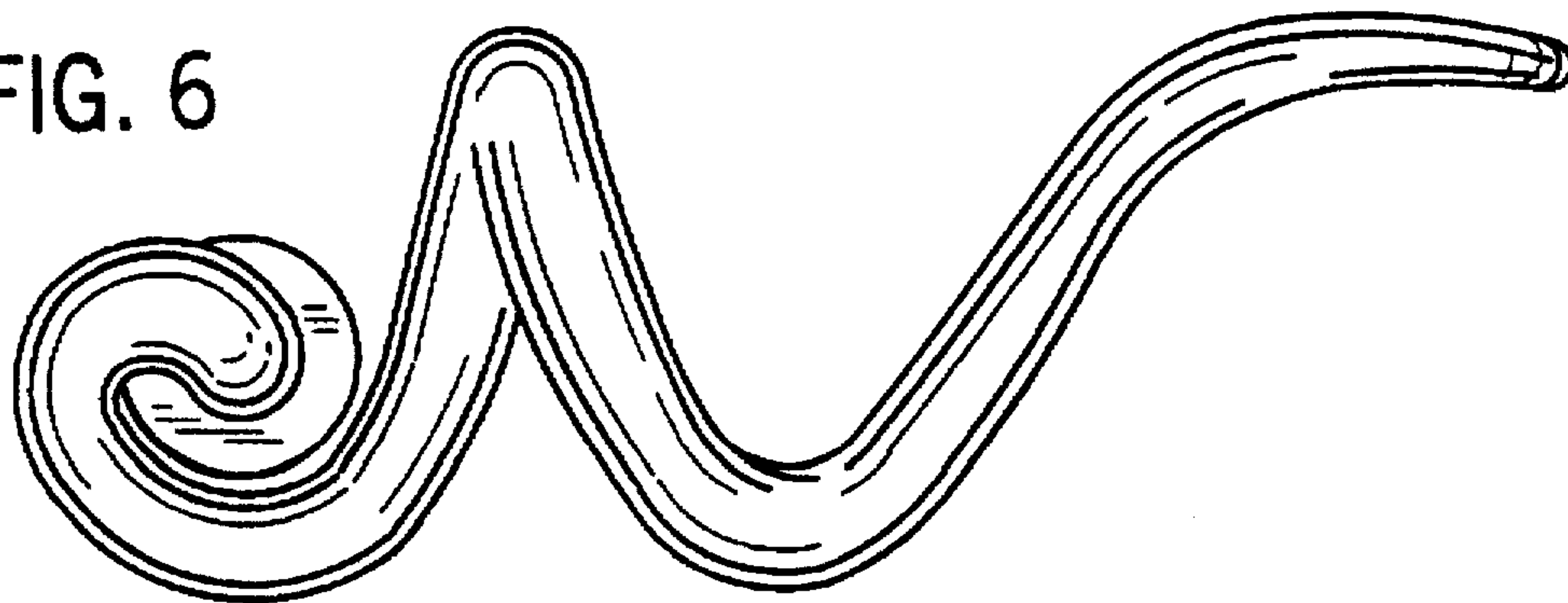

FIG. 6



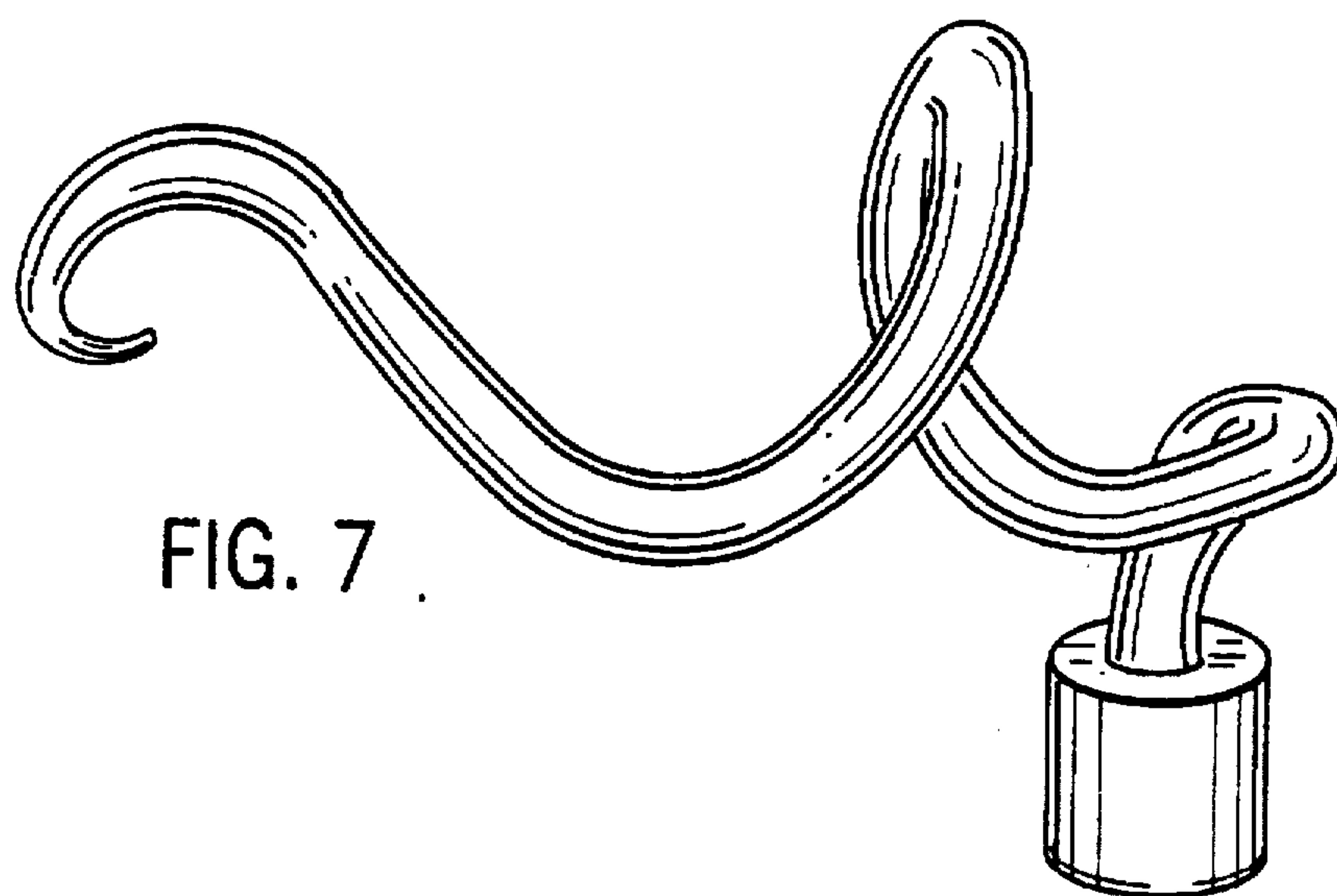

FIG. 7 .

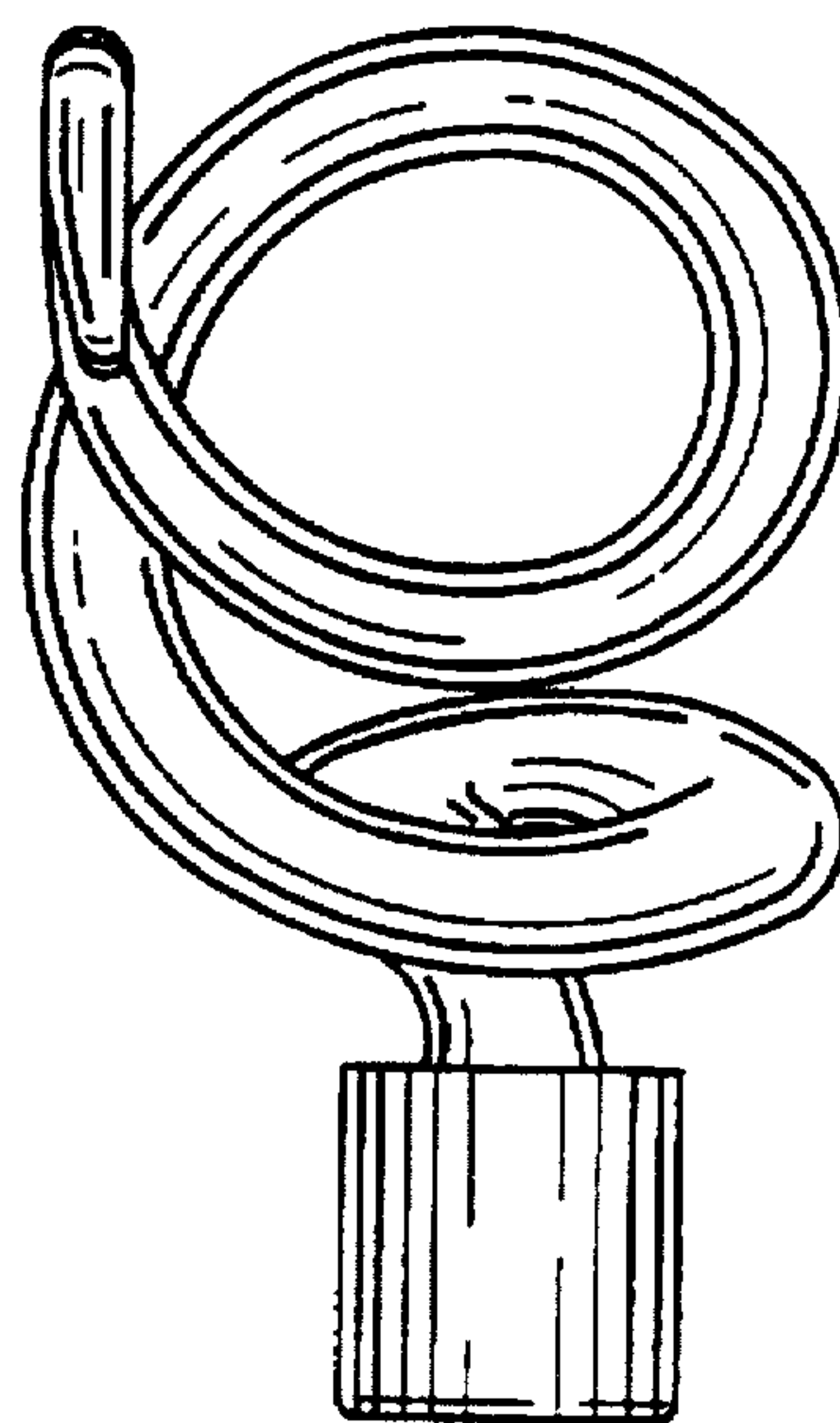

FIG. 8

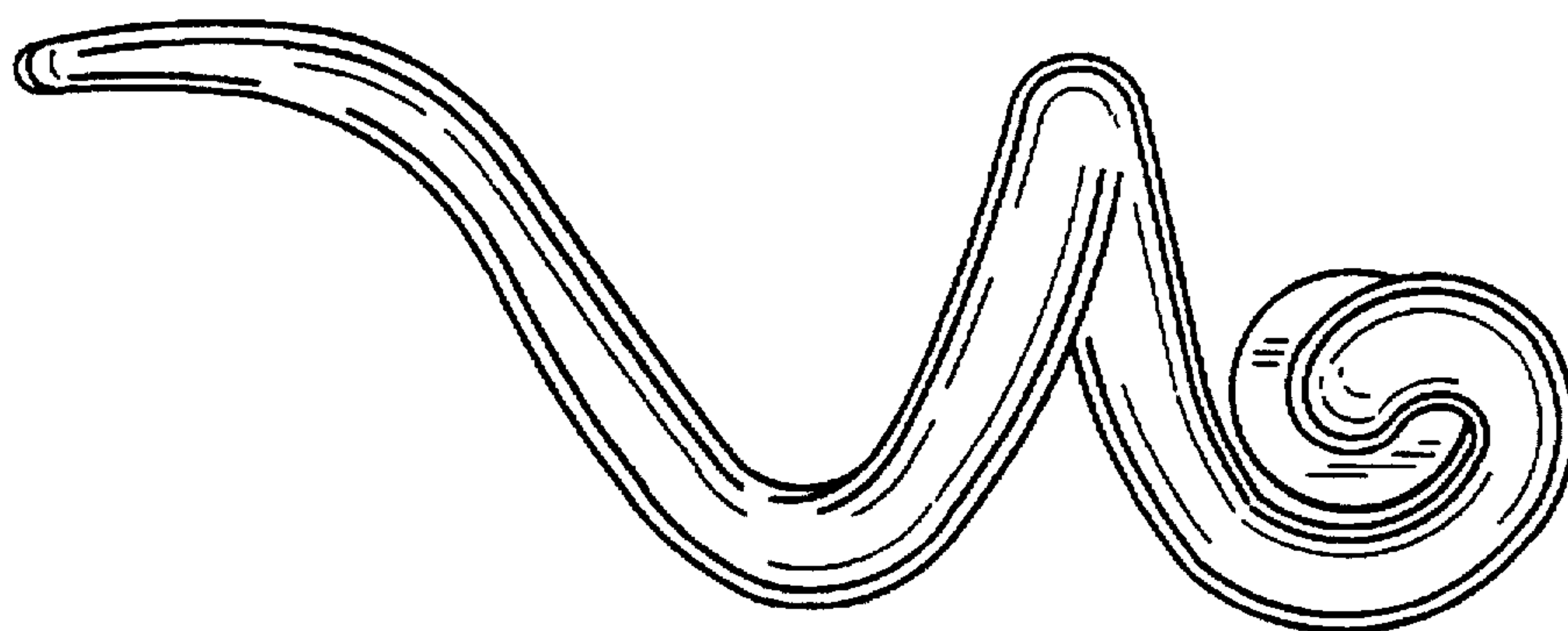

FIG. 9

FIG. 10

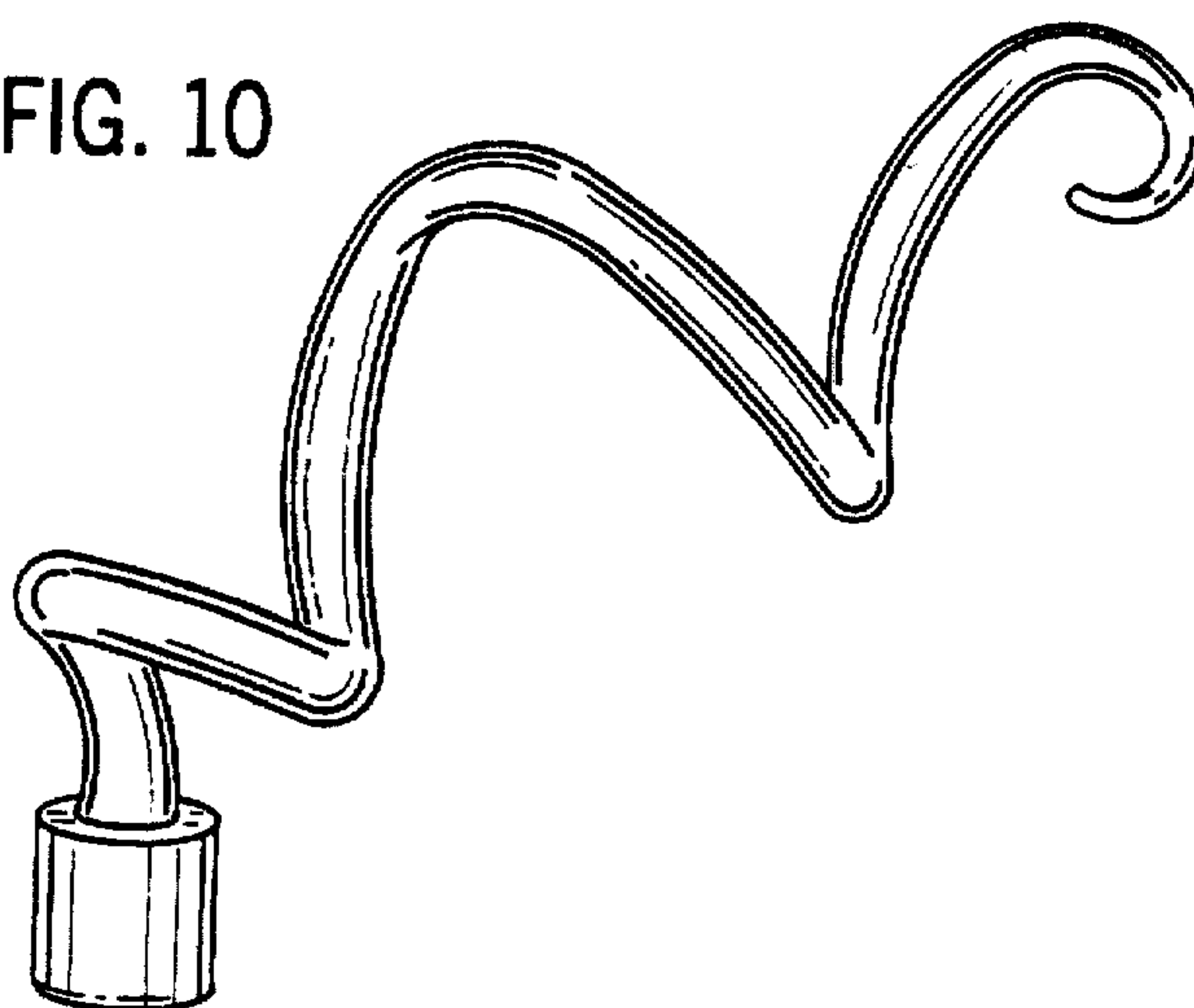

FIG. 11

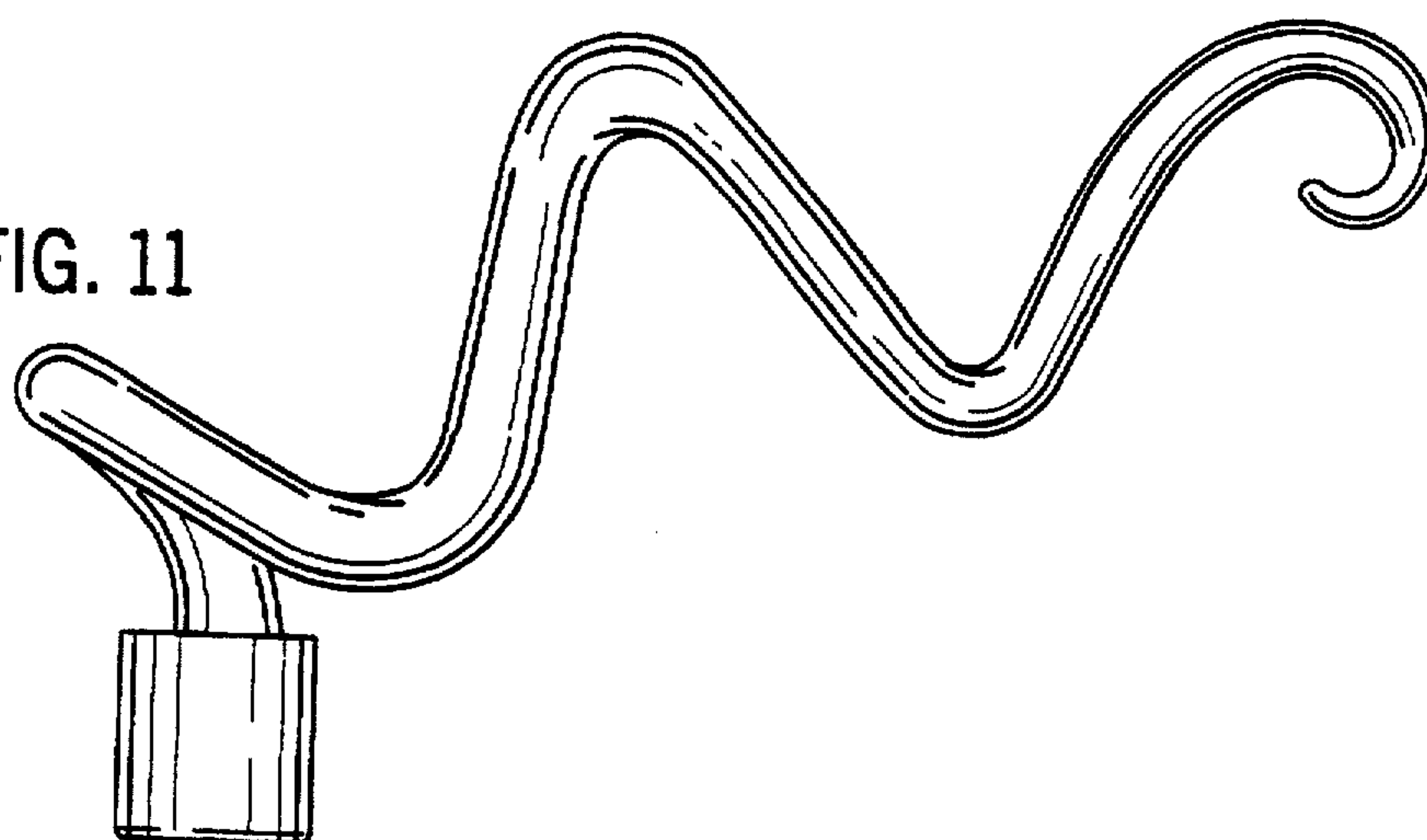

FIG. 12

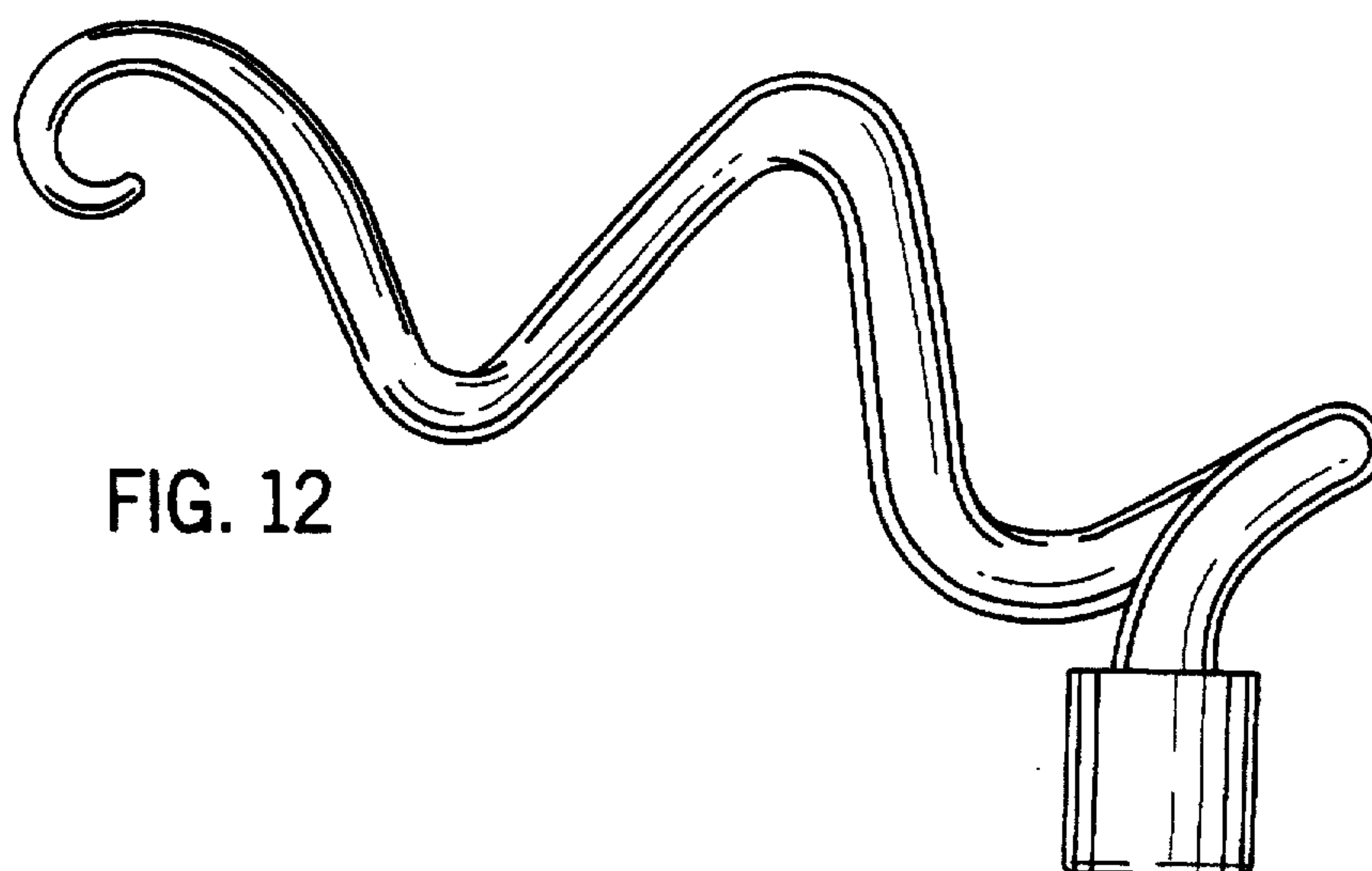

FIG. 13

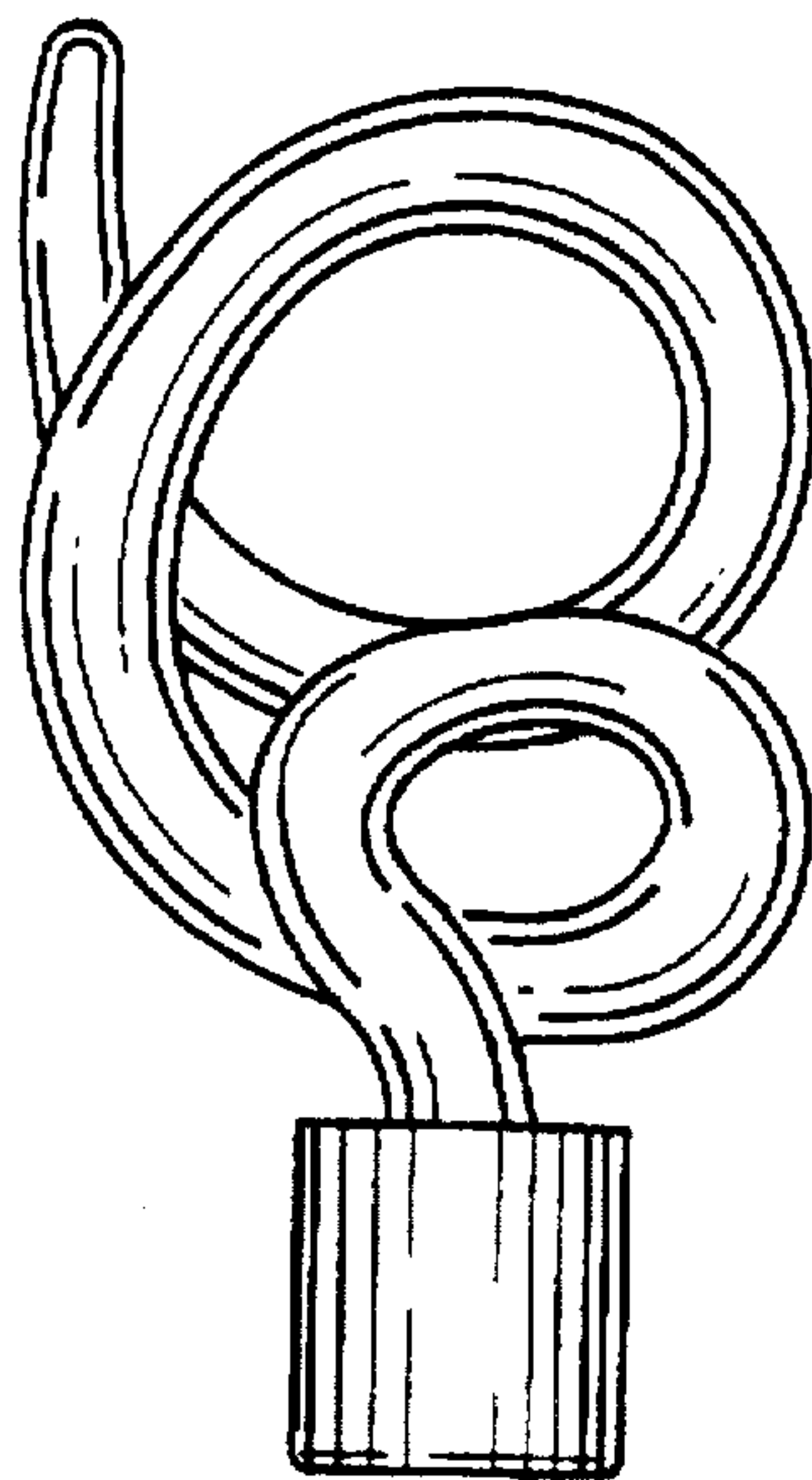

FIG. 14

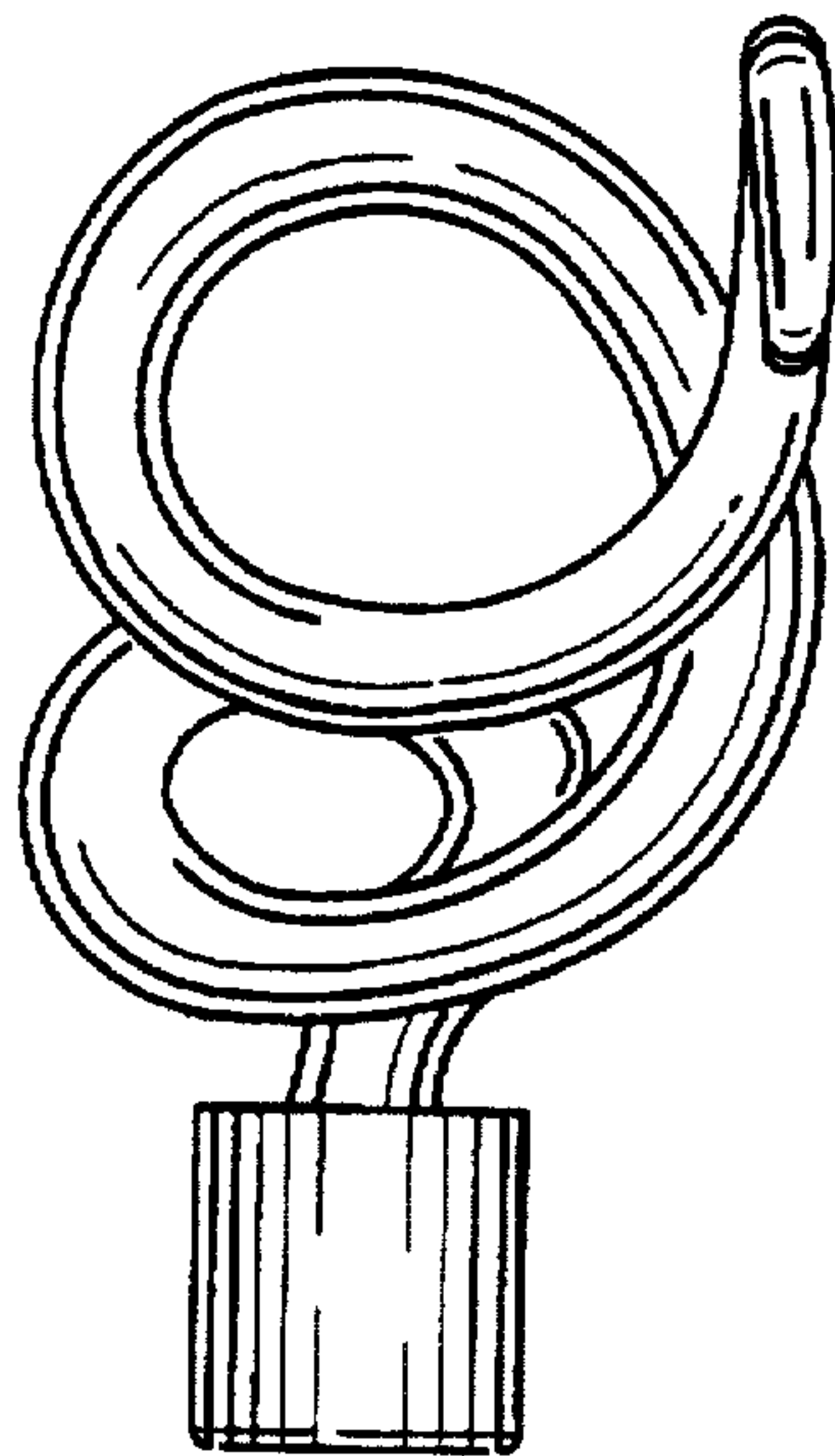

FIG. 15

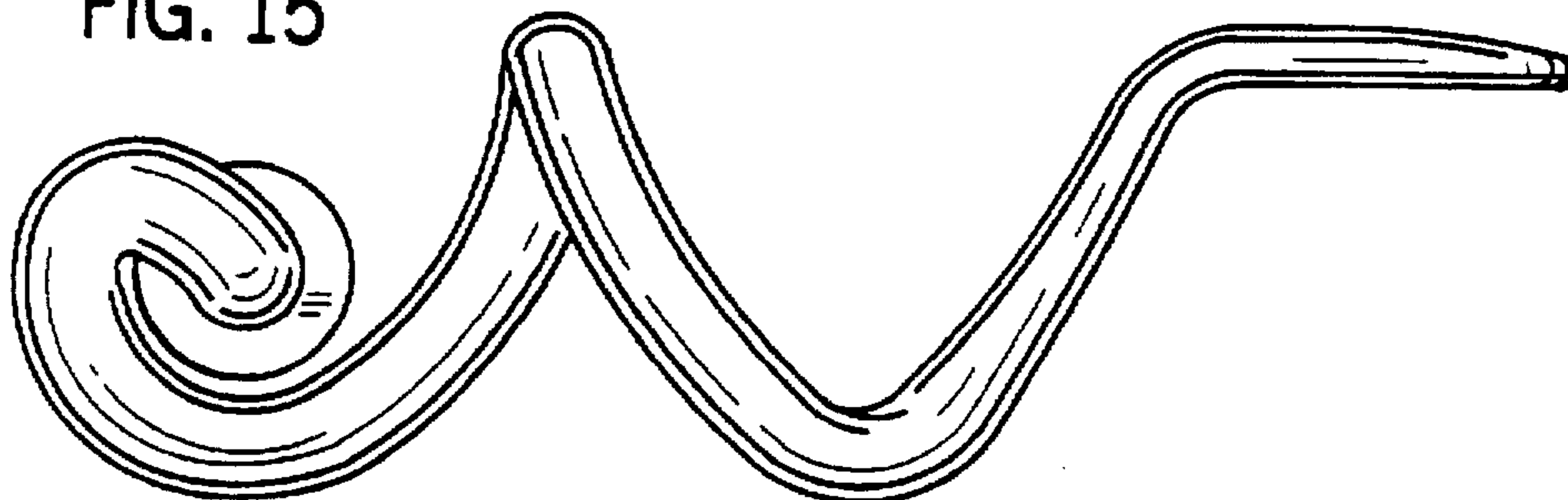

FIG. 16

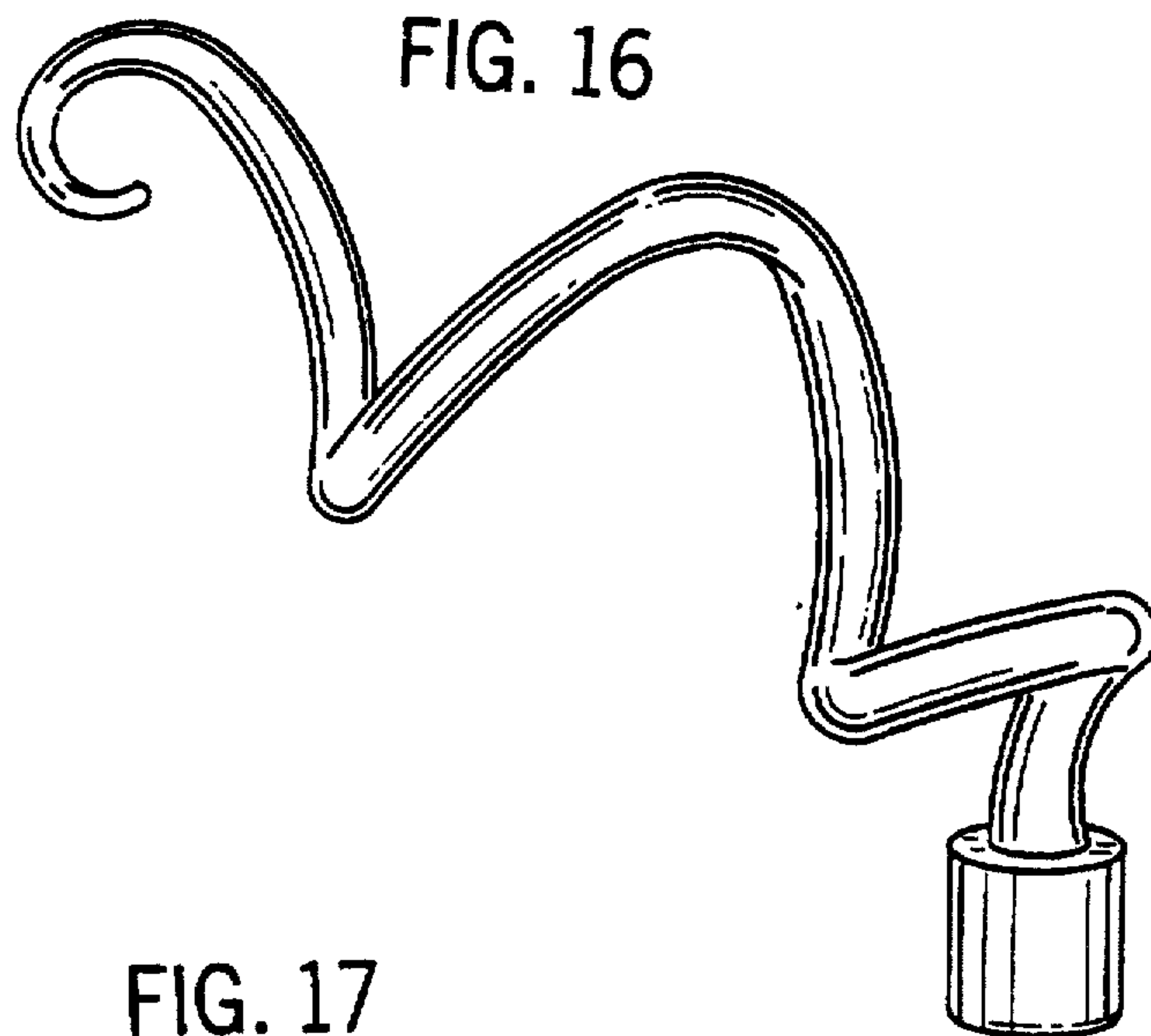

FIG. 17

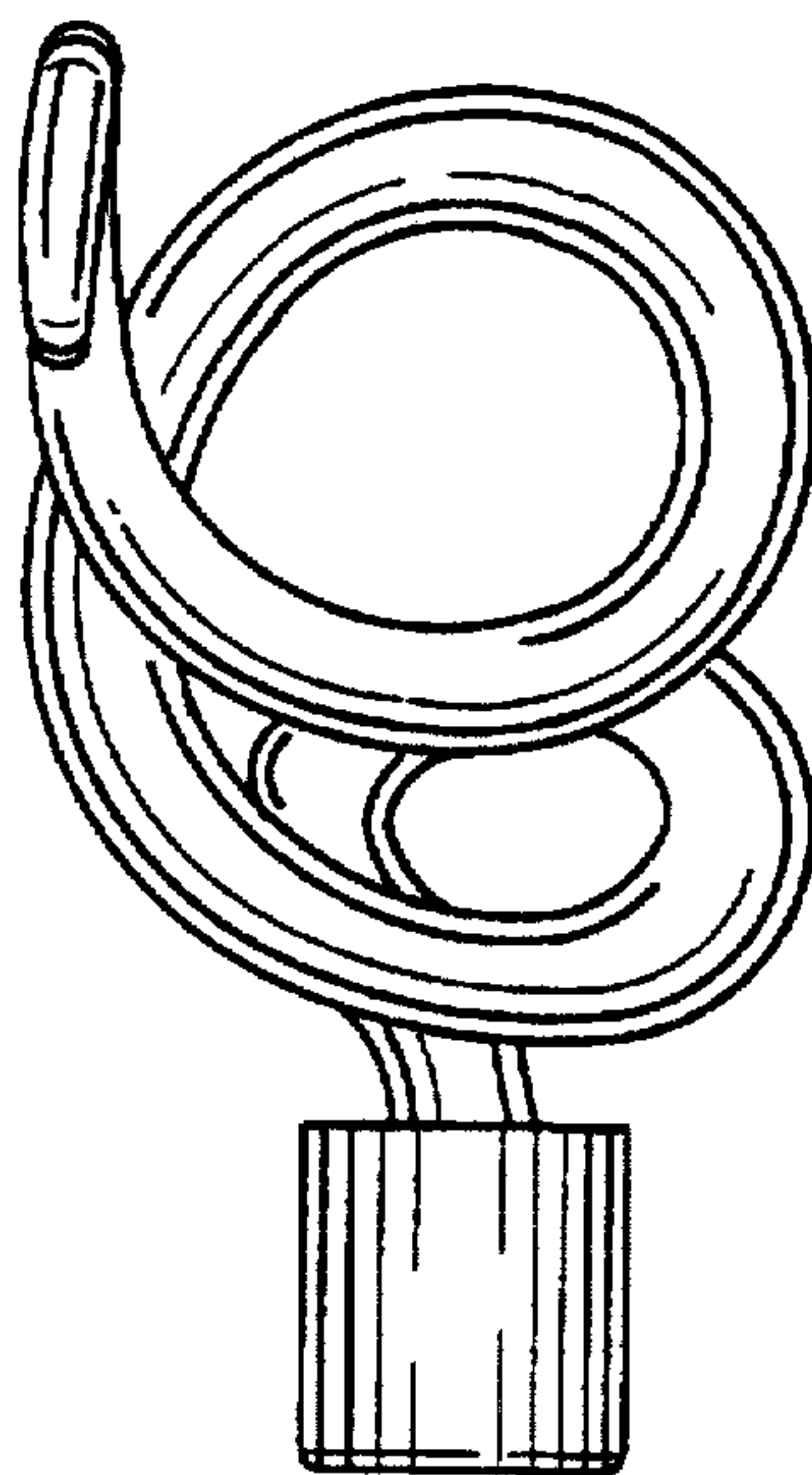
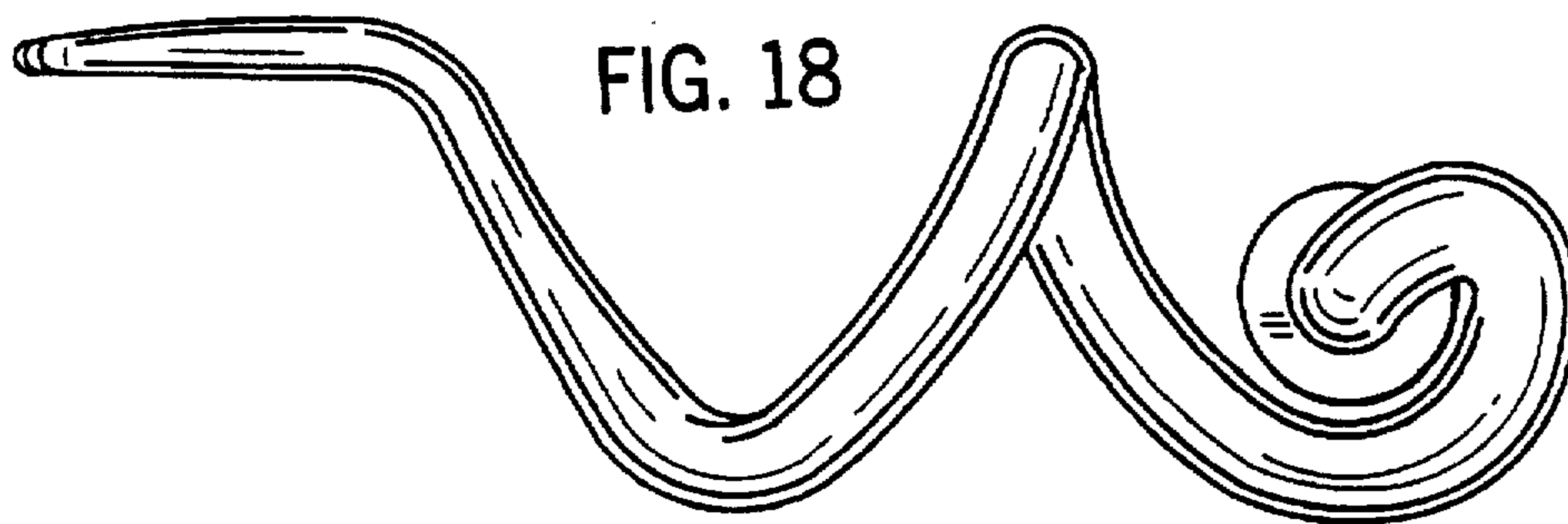

FIG. 18



UNITED STATES PATENT AND TRADEMARK OFFICE
CERTIFICATE OF CORRECTION

PATENT NO. : D385,955
DATED : November 4, 1997
INVENTOR(S) : Jill E. Hundley, et al.

It is certified that error appears in the above-identified patent and that said Letters Patent is hereby corrected as shown below:

On the title page, item [56],

"Poitasek et al." should read --Fojtasek et al.--

On the title page, under item [57],

The Fig. 1 description should read:

--Fig. 1 is a right, top, front perspective view of a handle for a plumbing fitting embodying our new design;--

Signed and Sealed this
Thirty-first Day of March, 1998

Attest:



BRUCE LEHMAN

Attesting Officer

Commissioner of Patents and Trademarks