



US00D385947S

# United States Patent [19]

Dow et al.

[11] Patent Number: **Des. 385,947**

[45] Date of Patent: **\*\*Nov. 4, 1997**

[54] **HAND HELD SHOWER HEAD**

[75] Inventors: **Ann M. Dow, Elmhurst; Joseph E. Ford, Cary; Donald N. Jursich, Chicago, all of Ill.; Raymond Chan, Tsuen Wan, Hong Kong**

[73] Assignee: **Sunbeam Products, Inc., Delray Beach, Fla.**

[\*\*] Term: **14 Years**

[21] Appl. No.: **48,874**

[22] Filed: **Jan. 11, 1996**

[51] LOC (6) Cl. .... **23-01**

[52] U.S. Cl. .... **D23/223**

[58] Field of Search ..... D23/213, 223-226, D23/229, 230; 239/525, 559, 556, 548, 459, 460, 394

[56] **References Cited**

**U.S. PATENT DOCUMENTS**

- D. 295,437 4/1988 Fabian .
- D. 327,729 7/1992 Rogers ..... D23/223
- D. 339,627 9/1993 Klose ..... D23/223

- D. 347,477 5/1994 Dow et al. .... D23/223
- D. 348,720 7/1994 Haug et al. .
- D. 349,557 8/1994 Huen ..... D23/223
- D. 349,947 8/1994 Hing-Wah ..... D23/223
- 4,674,687 6/1987 Smith et al. .
- 5,215,258 6/1993 Jursich ..... 239/394

*Primary Examiner*—Alan P. Douglas  
*Assistant Examiner*—Robin V. Taylor  
*Attorney, Agent, or Firm*—Michael J. Kline

[57] **CLAIM**

The ornamental design for a hand held shower head, as shown and described.

**DESCRIPTION**

FIG. 1 is a front perspective view of a hand held shower head showing our new design;  
FIG. 2 is a front elevational view thereof;  
FIG. 3 is a rear elevational view thereof;  
FIG. 4 is a top plan view thereof;  
FIG. 5 is a bottom plan view thereof;  
FIG. 6 is a left elevational view thereof;  
FIG. 7 is a right elevational view thereof; and,  
FIG. 8-10 are alternative face designs for the shower head as disclosed in FIGS. 1-7.

**1 Claim, 6 Drawing Sheets**

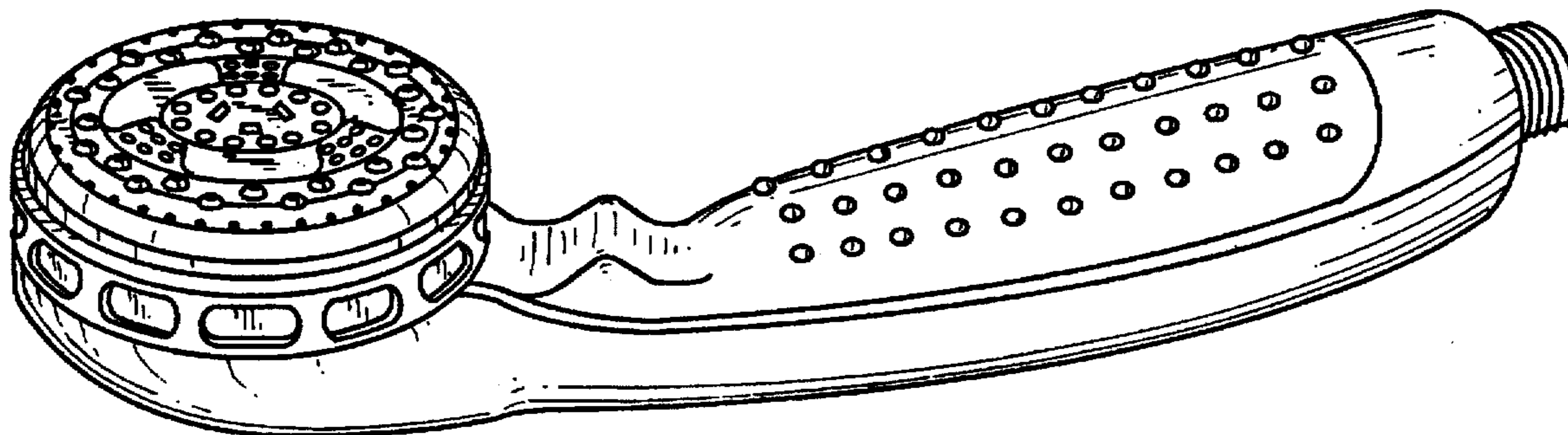

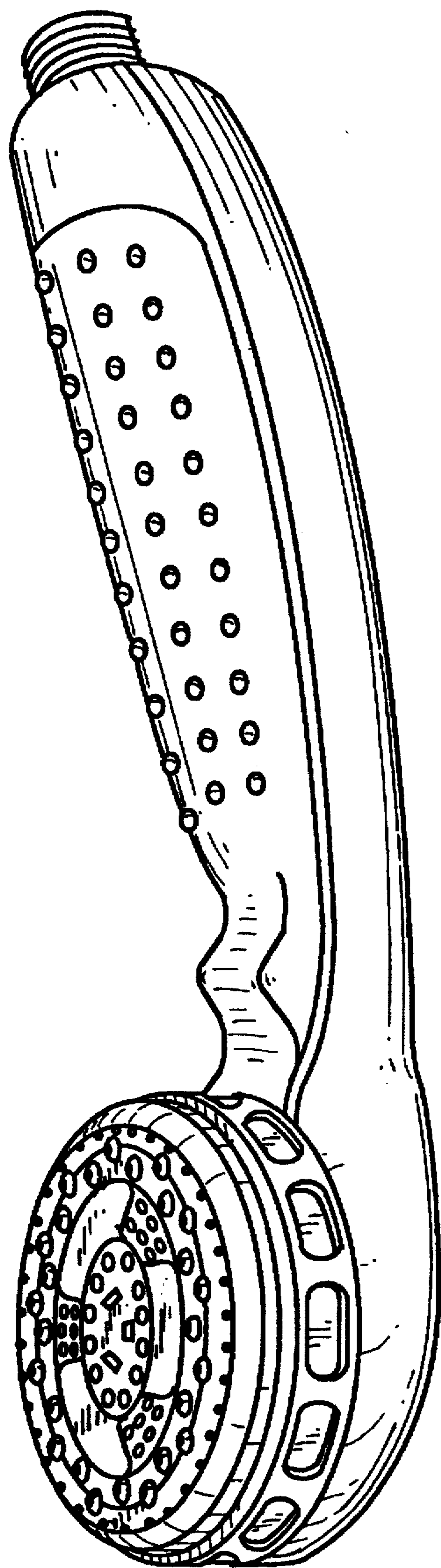

FIG. 1

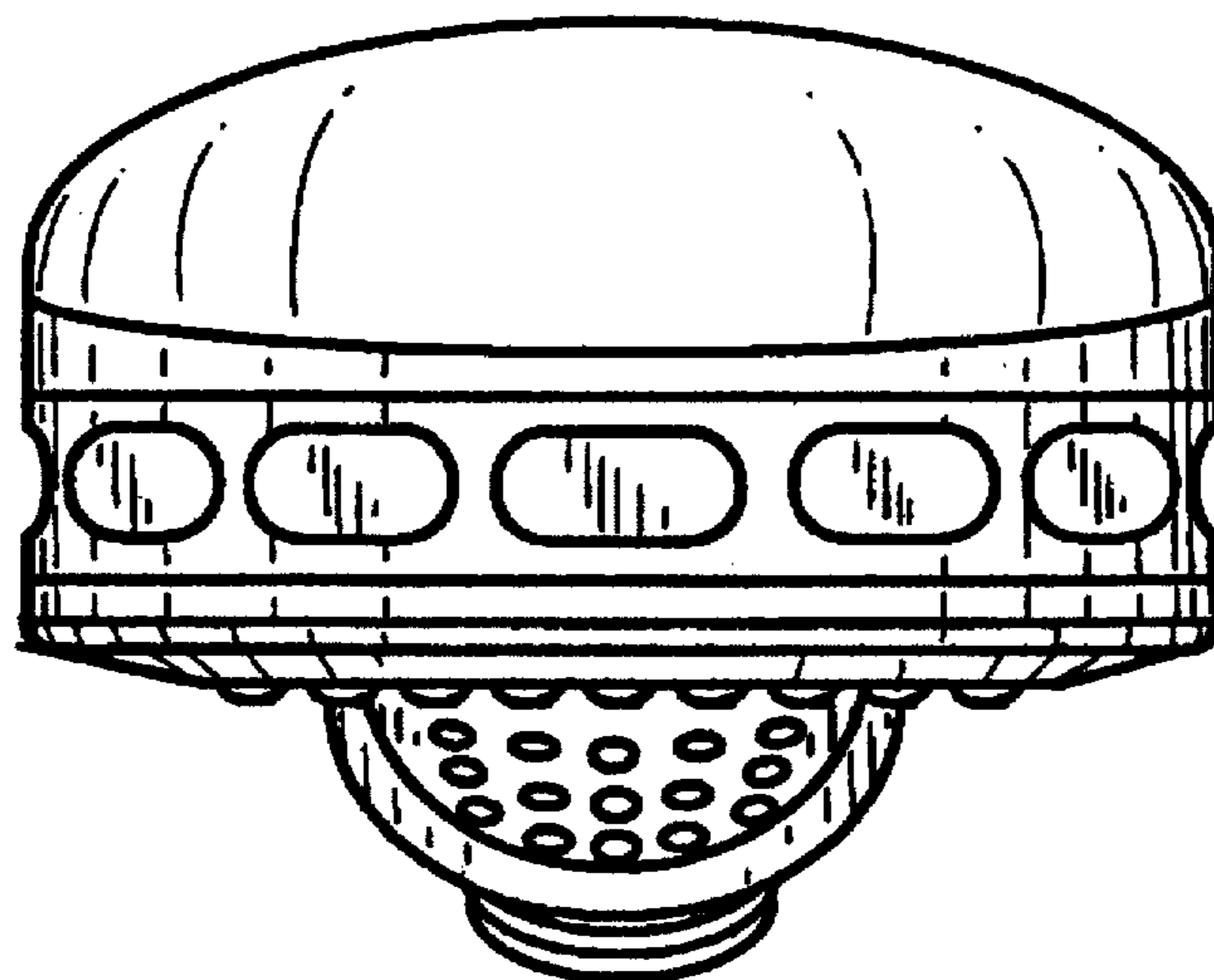

FIG. 2

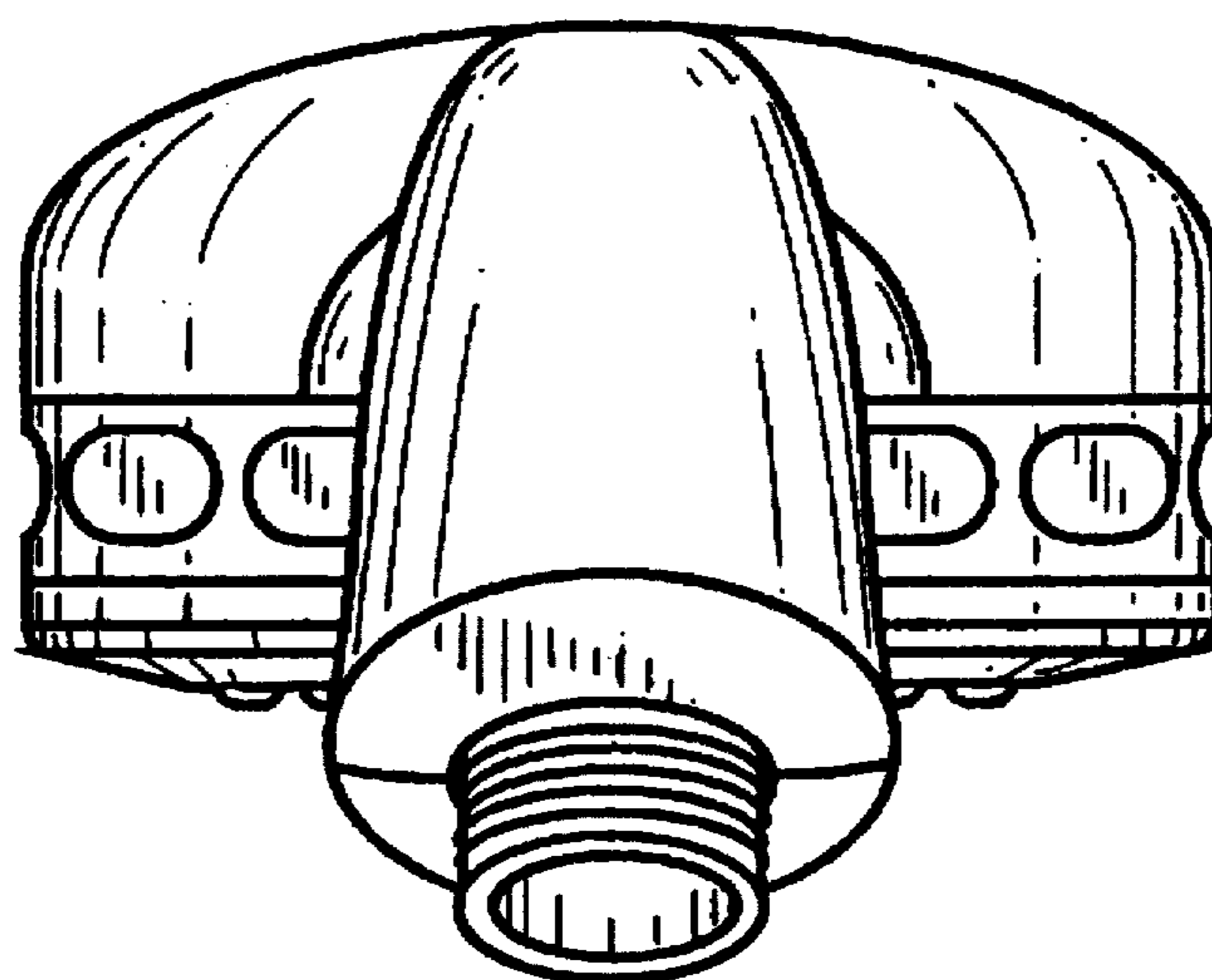

FIG. 3

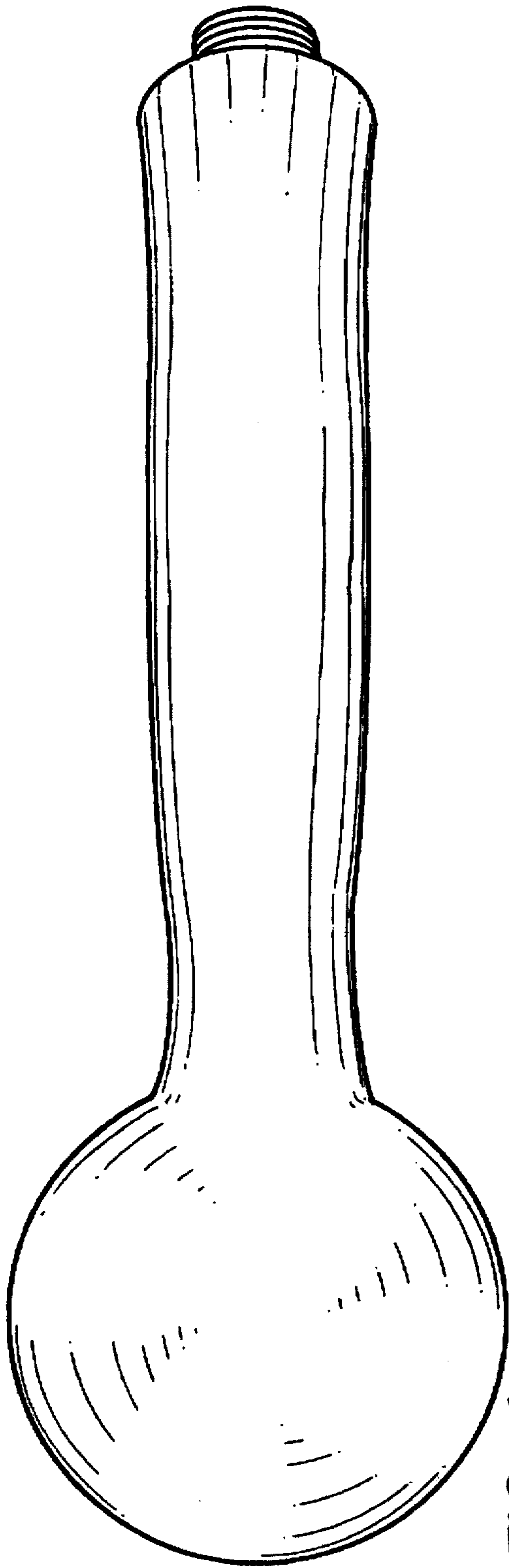

FIG. 4

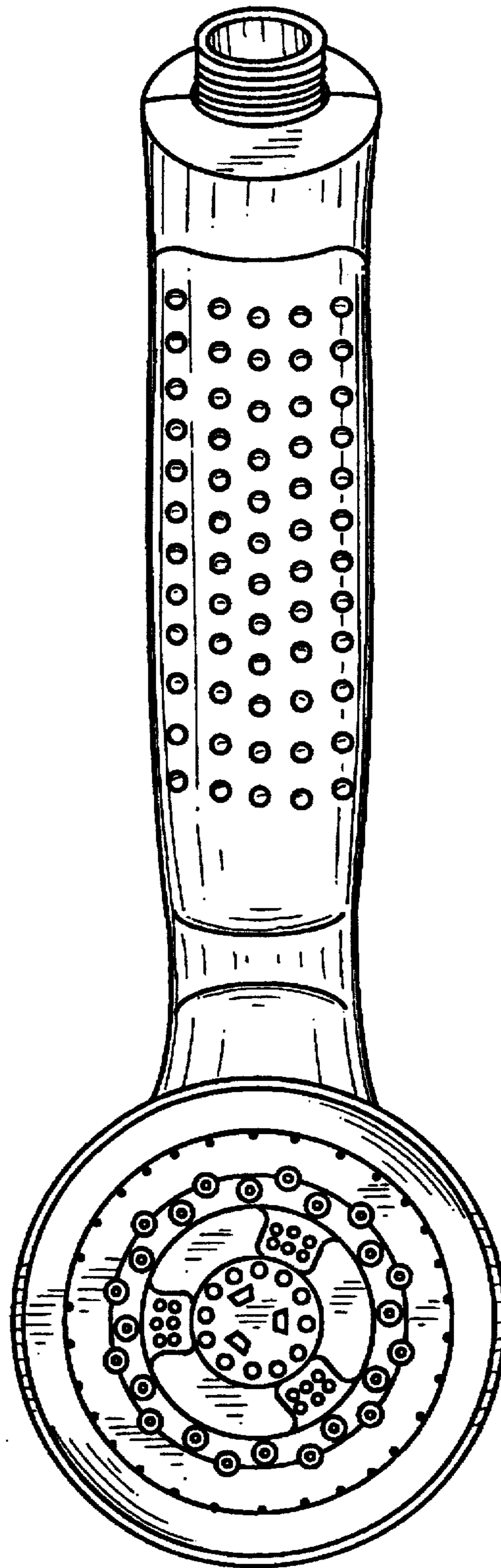

FIG. 5



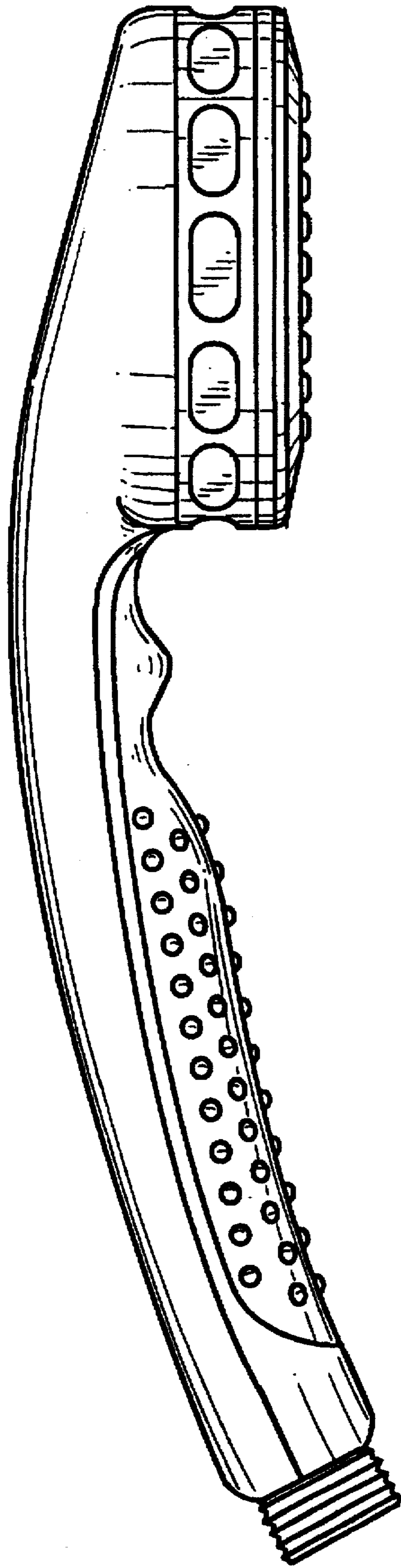

FIG. 6

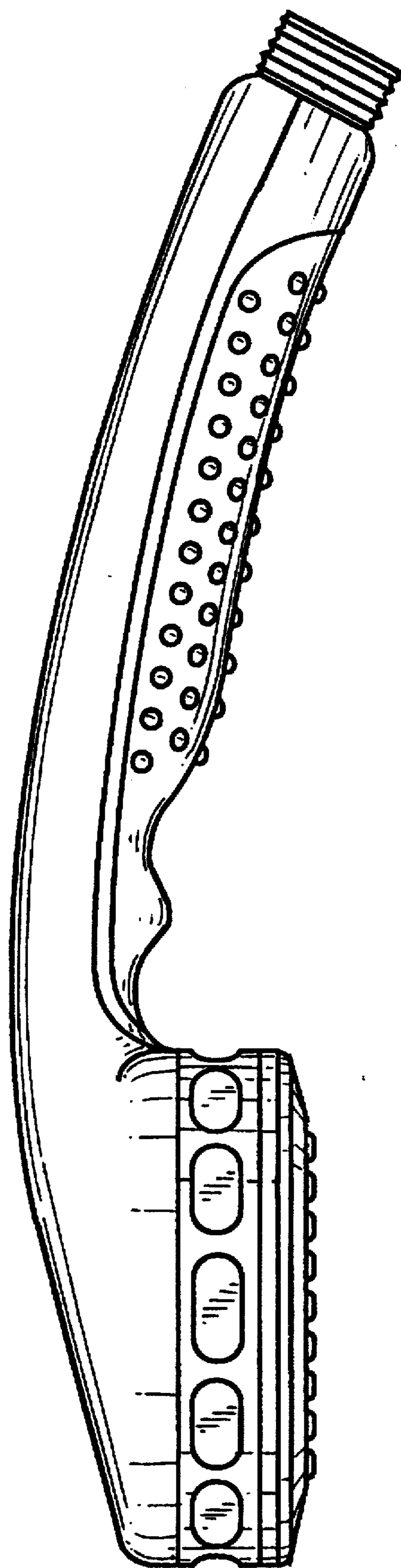

FIG. 7

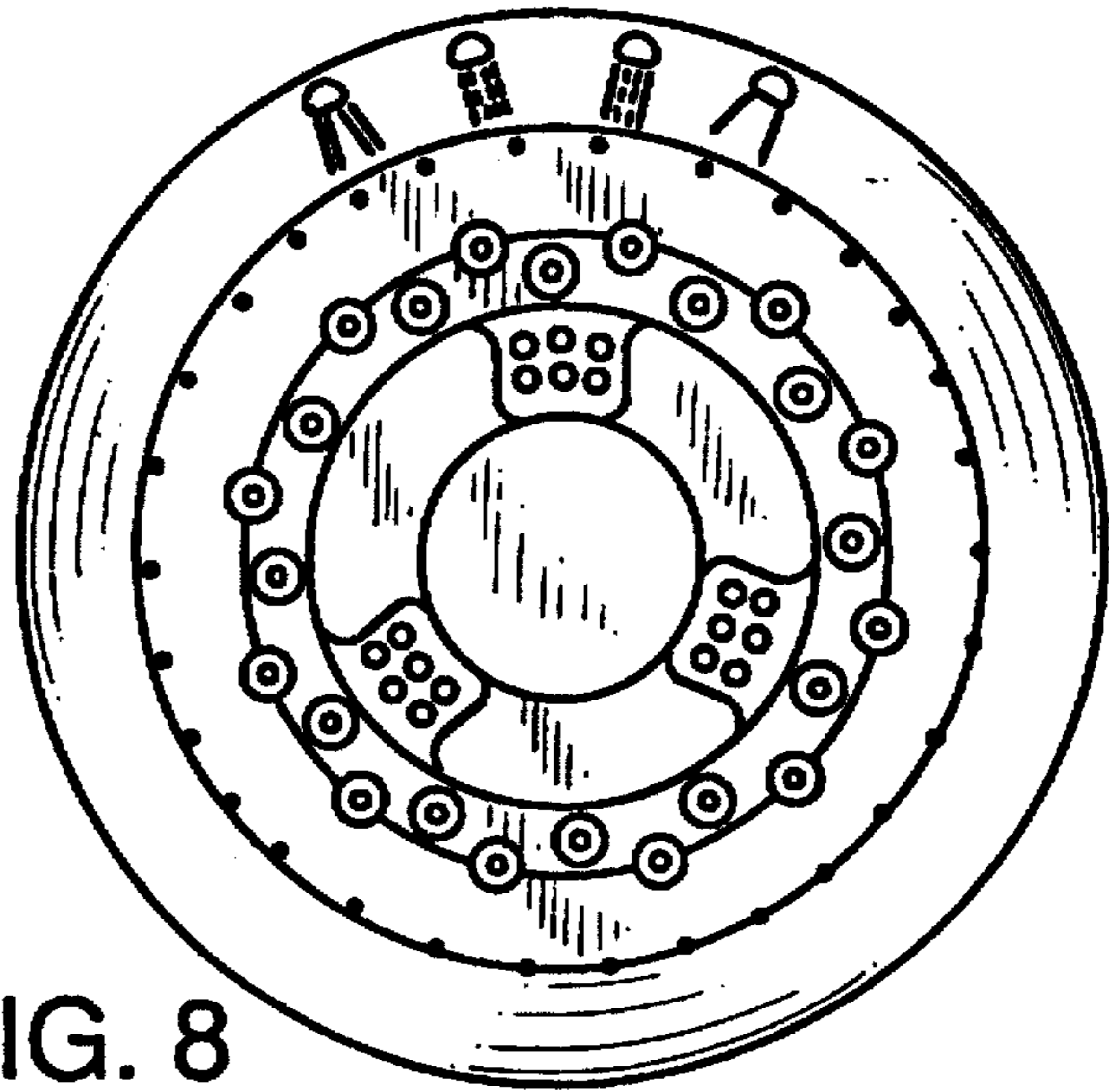

FIG. 8

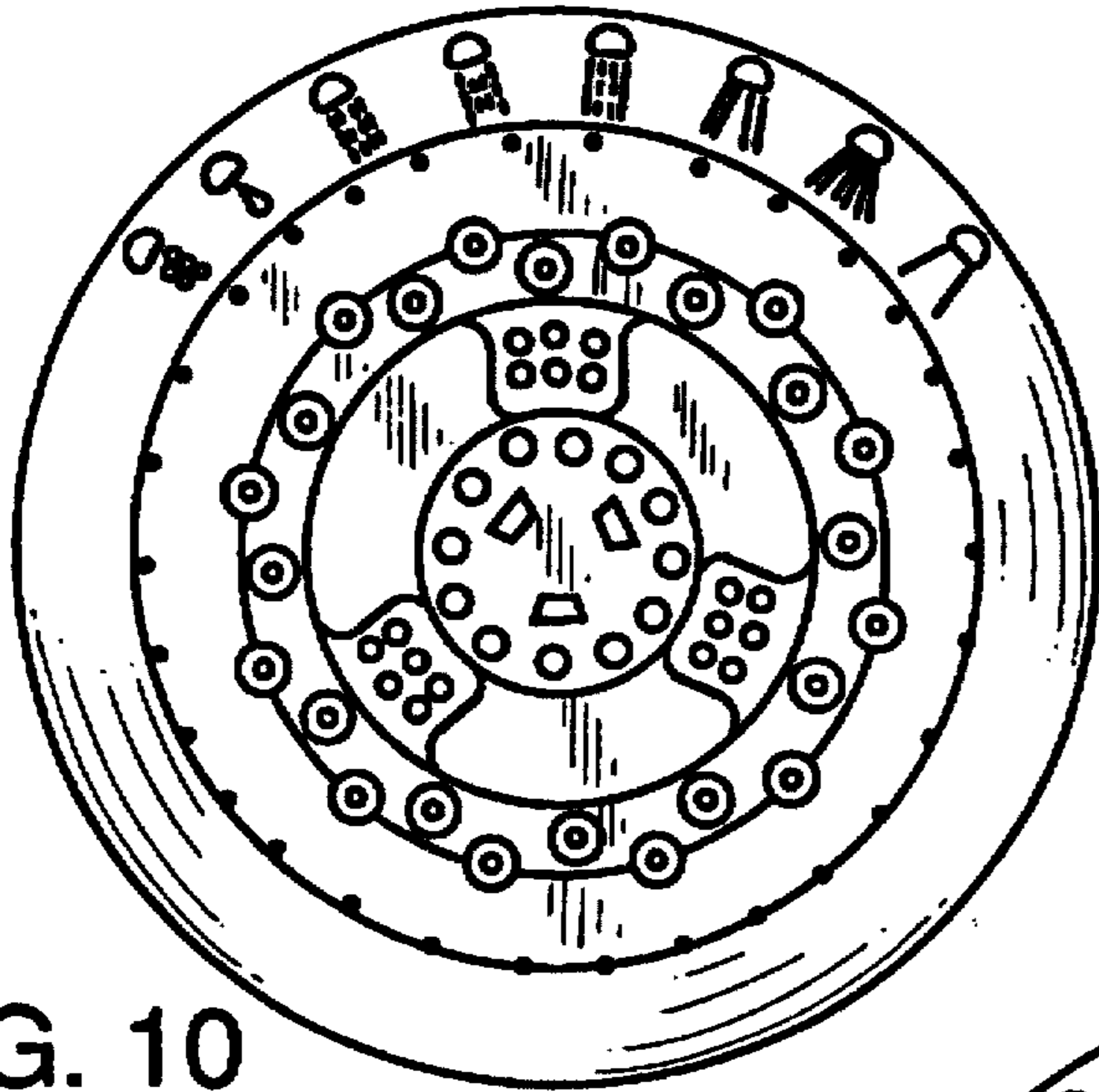

FIG. 10

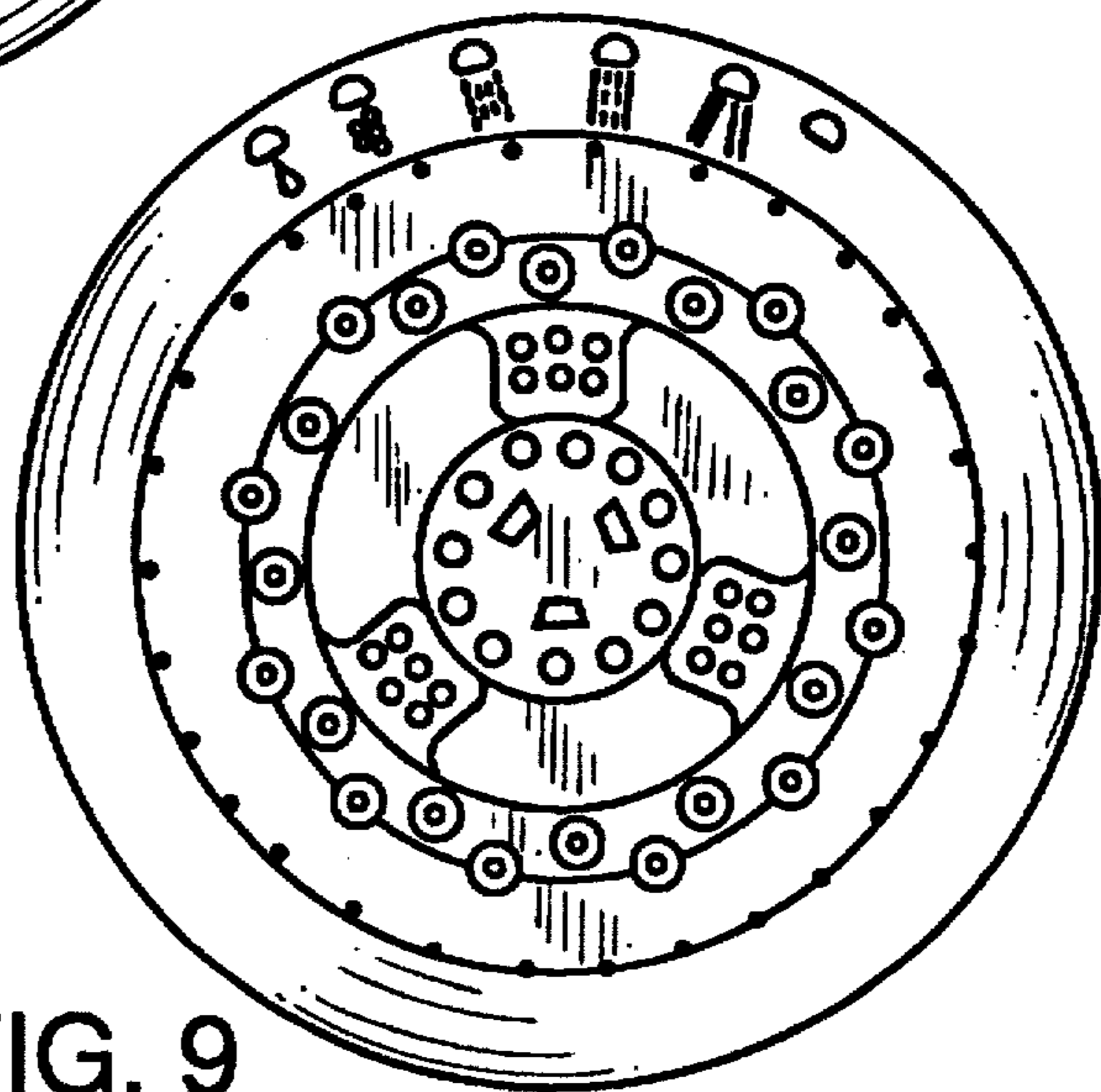

FIG. 9