

US00D385899S

# United States Patent [19]

Murphy et al.

[11] Patent Number: **Des. 385,899**

[45] Date of Patent: **\*\*Nov. 4, 1997**

[54] **FLIP UP TELESCOPES FOR SPECTACLES**

[75] Inventors: **Peter J. Murphy**, Port Washington;  
**Richard E. Feinbloom**, New York;  
**Amy S. Grumet Avallone**, Smithtown;  
**Gordon R. Perry**, New York, all of  
N.Y.

[73] Assignee: **Designs For Vision, Inc.**, Ronkonkoma,  
N.Y.

[\*\*] Term: **14 Years**

[21] Appl. No.: **50,198**

[22] Filed: **Feb. 12, 1996**

[51] LOC (6) Cl. .... **16-06**

[52] U.S. Cl. .... **D16/330**

[58] Field of Search ..... D16/101, 309,  
D16/330, 334, 132, 130, 131, 133; 351/41,  
44, 47, 48, 57-60, 158, 159; 359/399, 408-410,  
433, 480-481

[56] **References Cited**

**U.S. PATENT DOCUMENTS**

- D. 235,800 7/1975 Van Exel ..... D16/132
- D. 345,368 3/1994 Clark et al. .... D16/132

2,414,757	1/1947	Mitby et al. ....	351/58
2,422,661	6/1947	Ellis .....	351/57
2,758,506	8/1956	McNeill .....	351/57
4,865,438	9/1989	Wada .....	351/158
5,076,682	12/1991	Pasfield .....	351/158
5,381,263	1/1995	Nowak et al. ....	351/58
5,446,507	8/1995	Chang .....	351/57

*Primary Examiner*—Raphael Barkai  
*Attorney, Agent, or Firm*—Plevy & Associates

[57] **CLAIM**

The ornamental design for flip up telescopes for spectacles,  
as shown and described.

**DESCRIPTION**

FIG. 1 is a perspective view of flip up telescopes for spectacles showing my new design;  
 FIG. 2 is a front elevational view thereof;  
 FIG. 3 is a rear elevational view thereof;  
 FIG. 4 is an elevational view thereof, the side opposite being a mirror image;  
 FIG. 5 is a top plan view thereof; and,  
 FIG. 6 is a bottom plan view thereof.

The broken line showing of the spectacles in FIGS. 1-6 is for illustrative purposes only and forms no part of the claimed design.

**1 Claim, 5 Drawing Sheets**

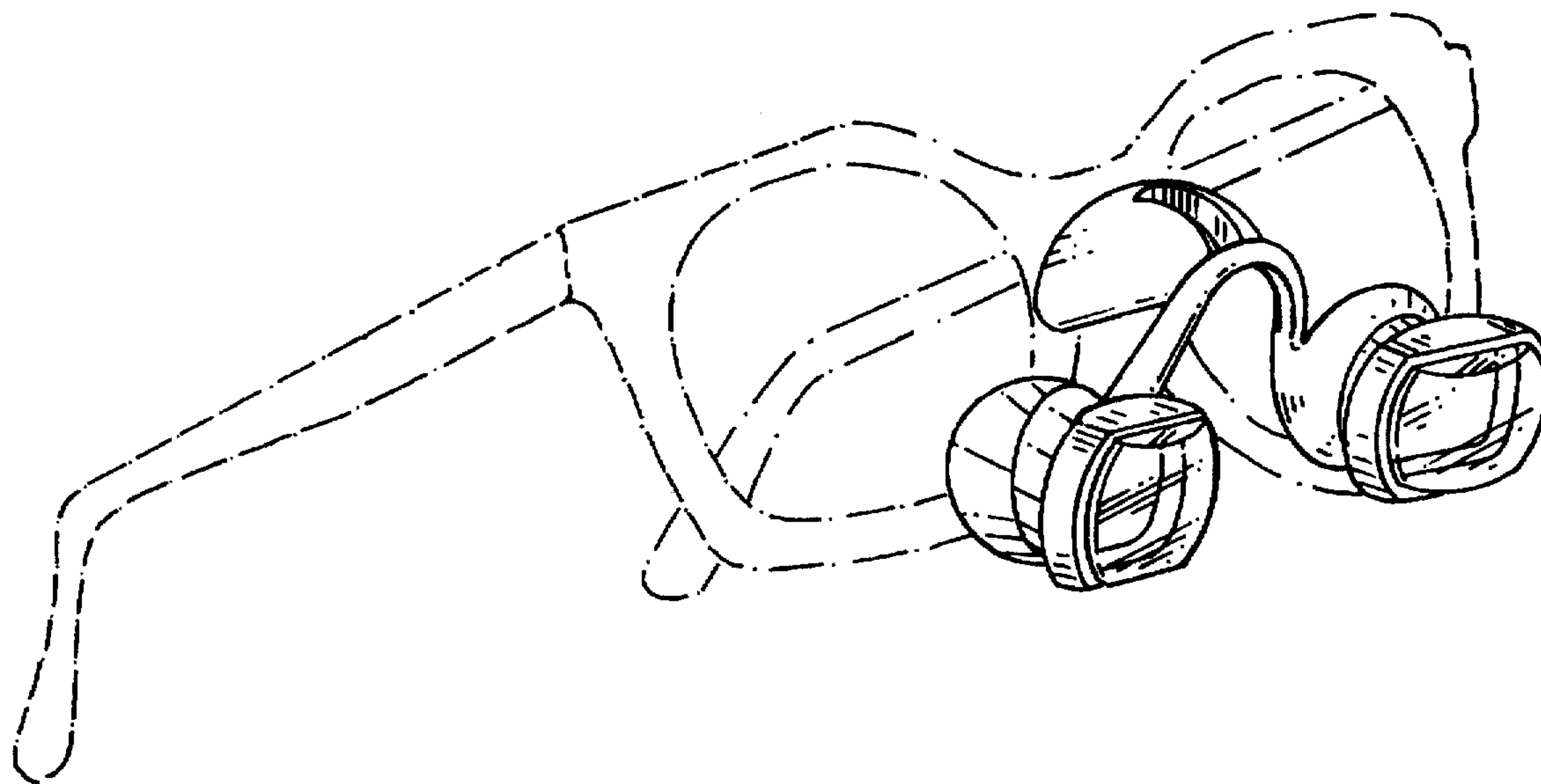

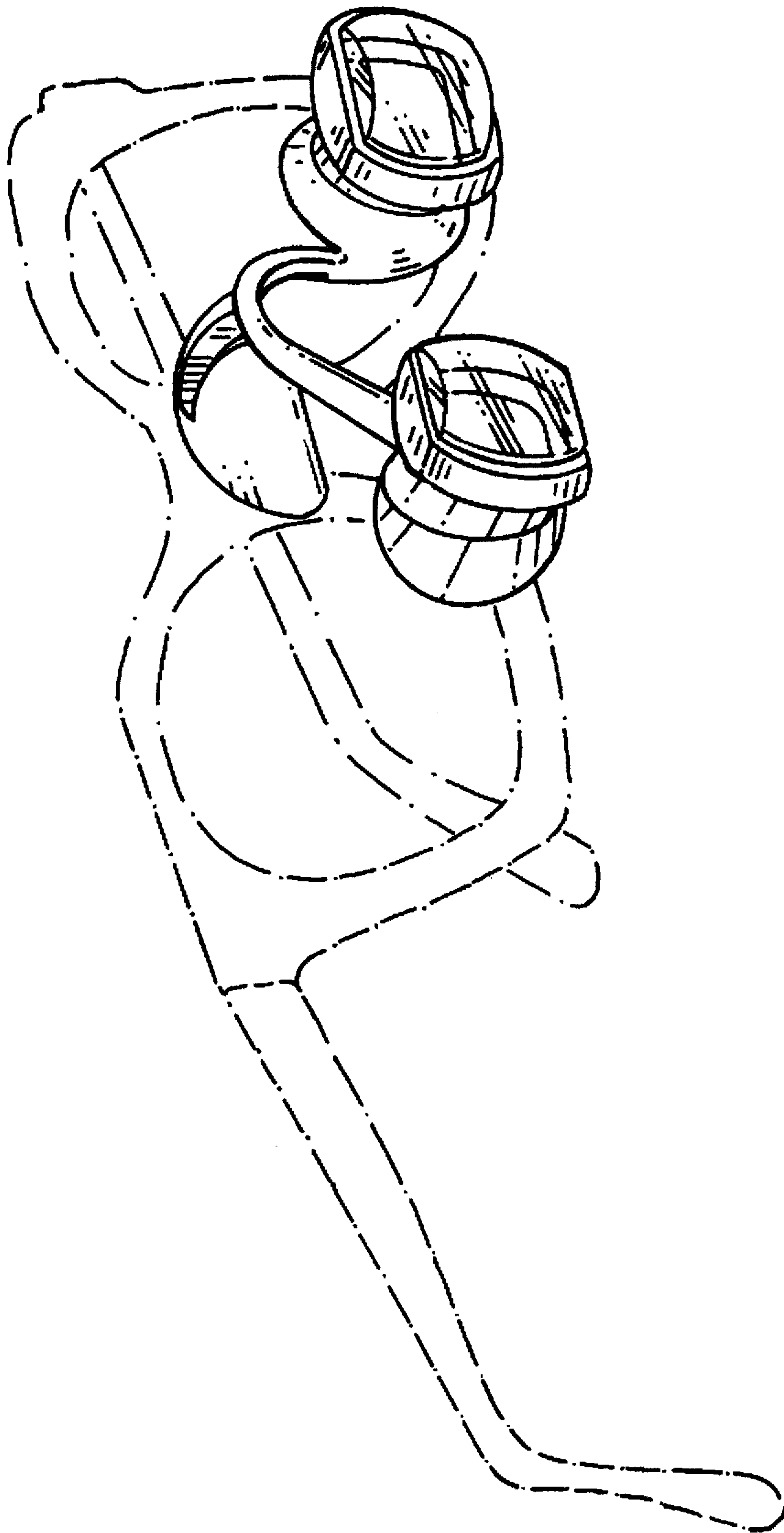

FIG. 1

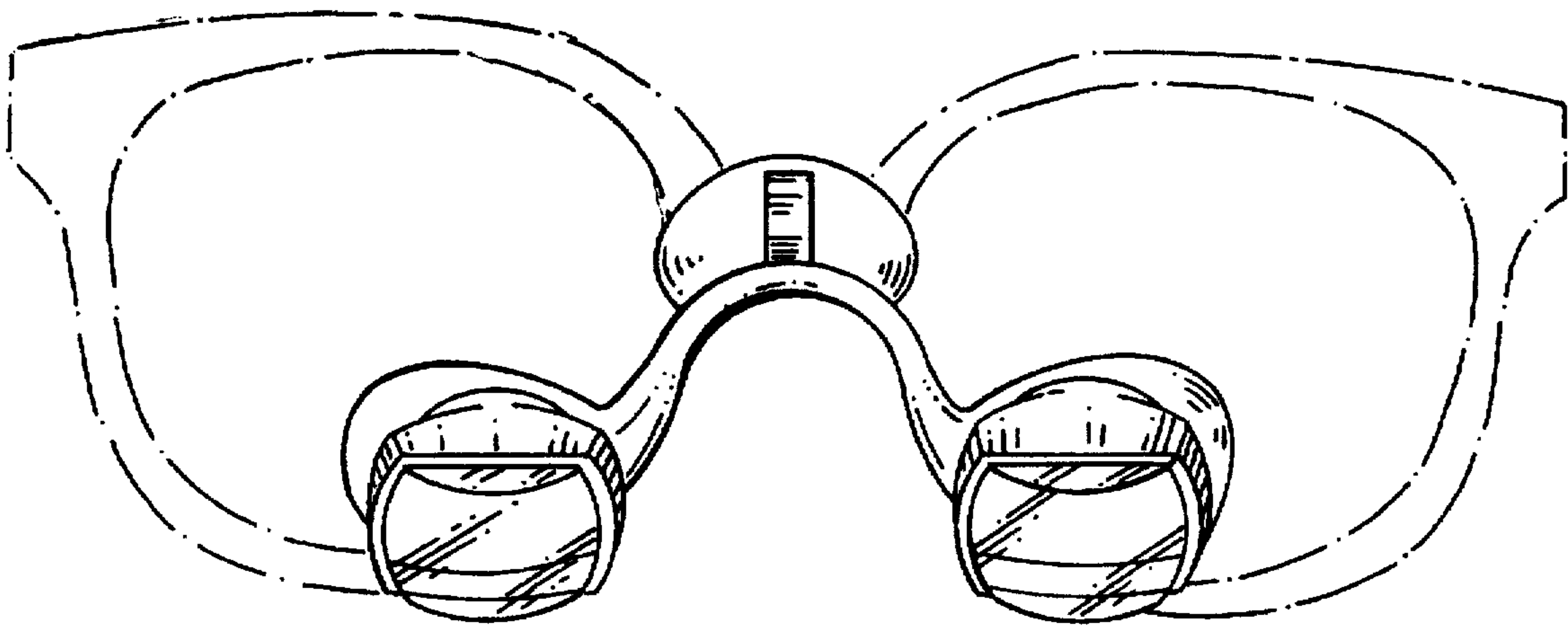

FIG. 2

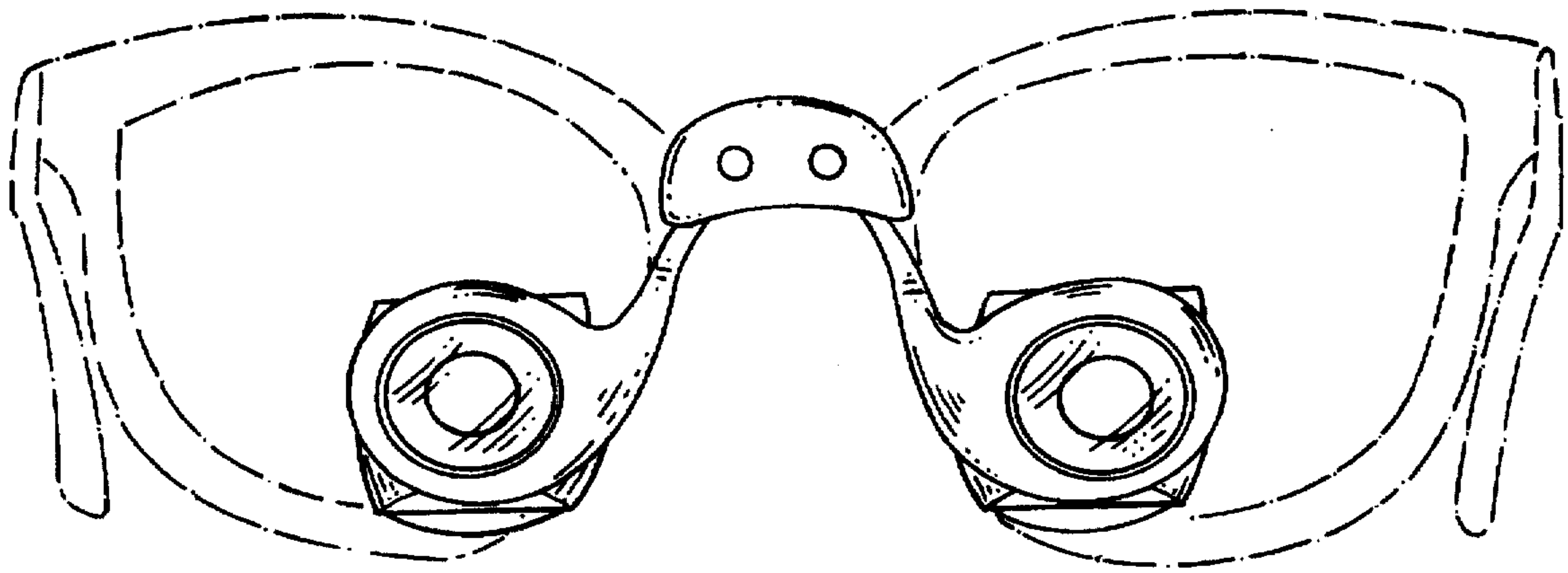

FIG. 3

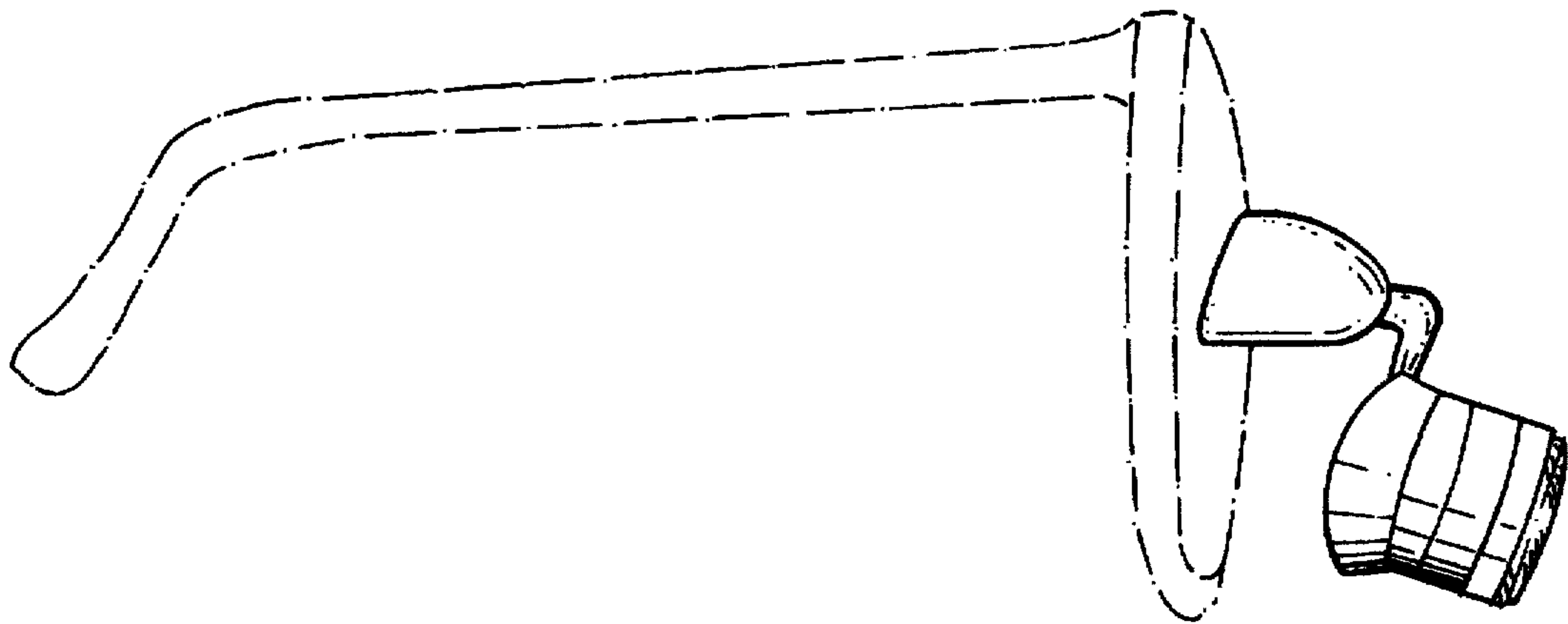

FIG. 4

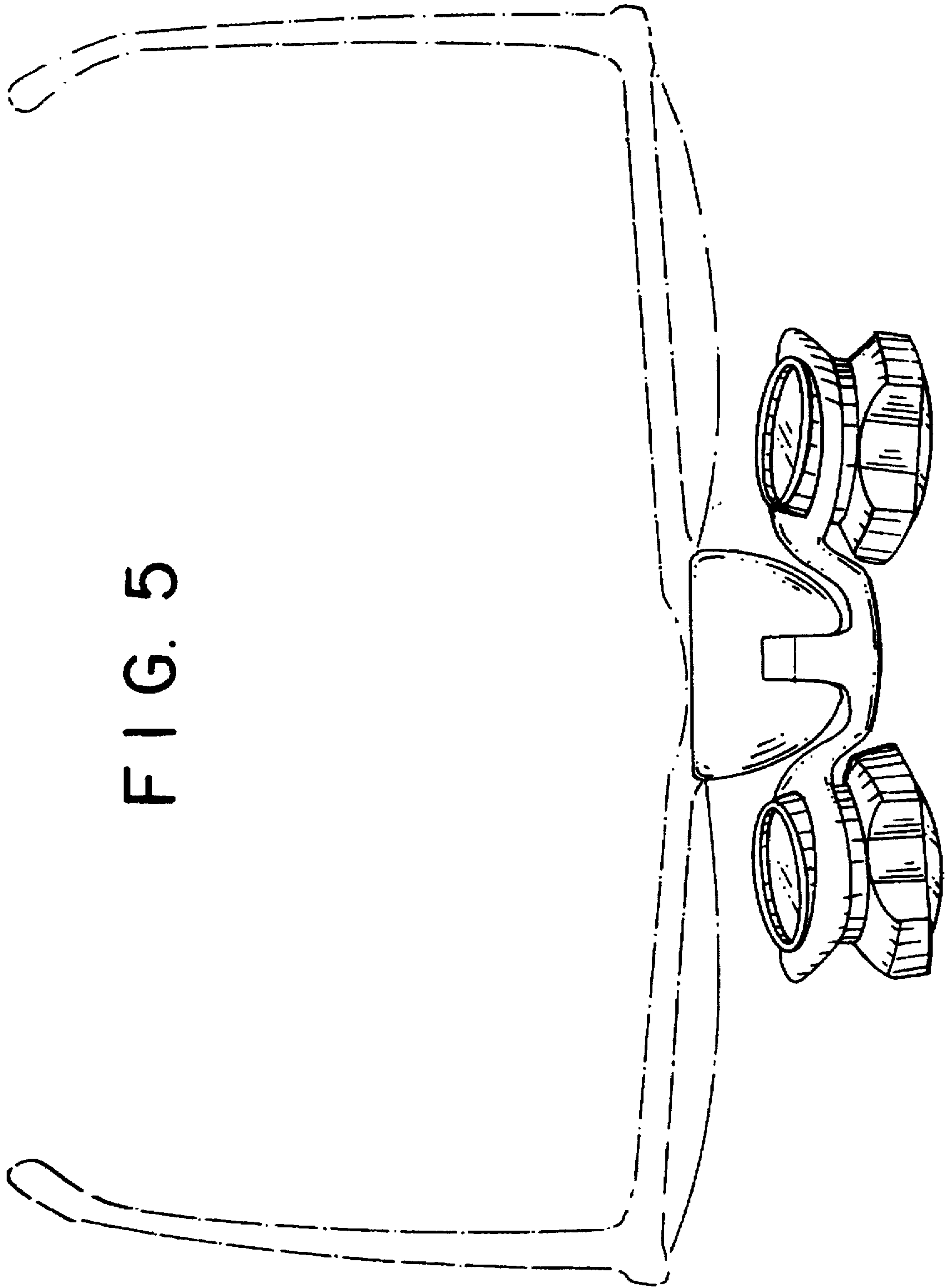

FIG. 5

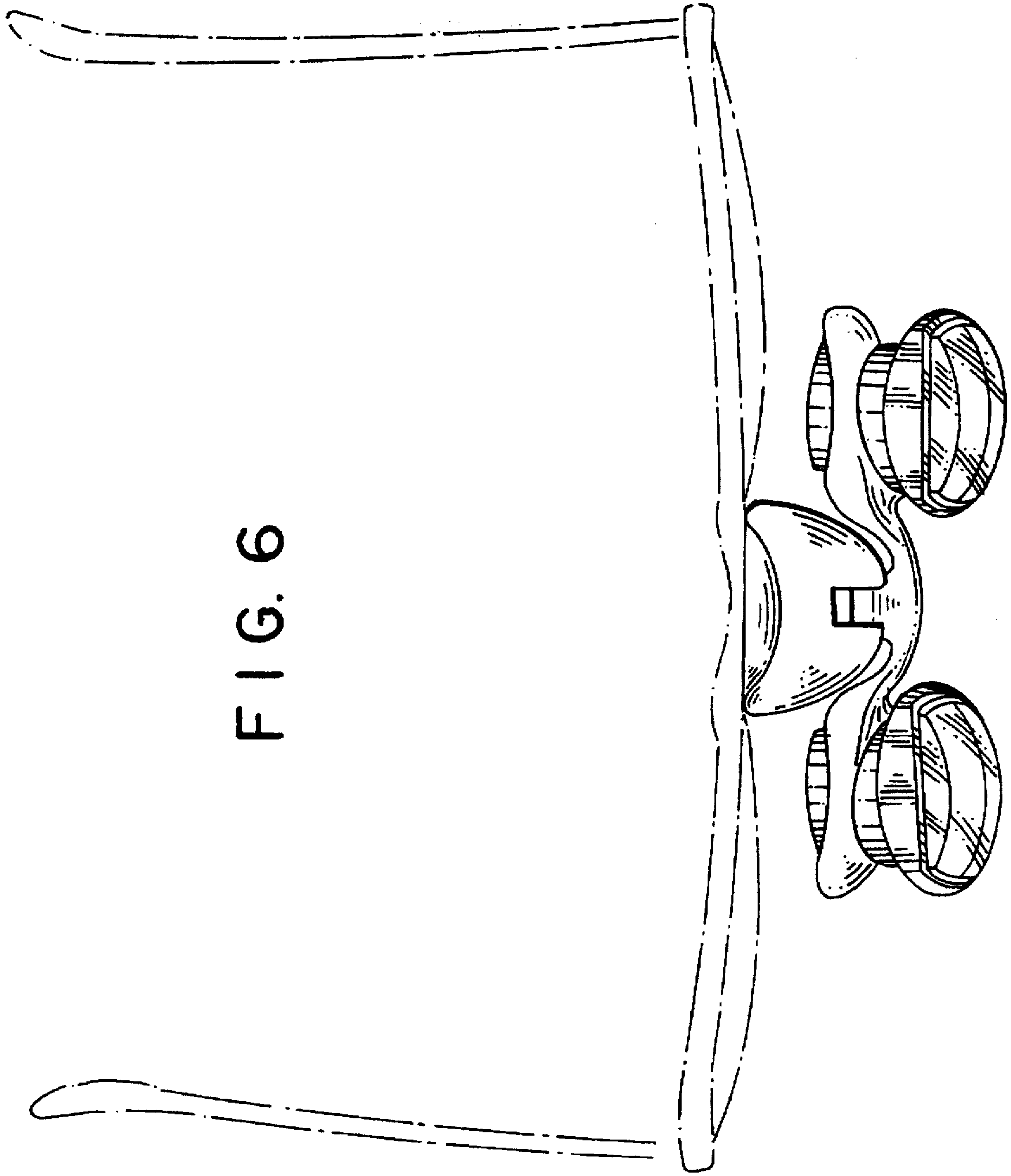

FIG. 6