



US00D385898S

United States Patent [19]
Fujimoto

[11] **Patent Number: Des. 385,898**
[45] **Date of Patent: **Nov. 4, 1997**

[54] **EYEGLASS WITH SUN SHADE**
[76] **Inventor: Shinji Fujimoto, 1040 Lunalilo St.,
Apt. 1201, Honolulu, Hi. 96822**
[**] **Term: 14 Years**
[21] **Appl. No.: 59,860**
[22] **Filed: Sep. 17, 1996**
[51] **LOC (6) Cl. 16-06**
[52] **U.S. Cl. D16/310**
[58] **Field of Search D16/300, 306,
D16/309-311, 315-317, 319-321, 325-330,
340; D2/866, 868, 872, 879, 882; 351/41,
44, 51, 52, 158; 2/12, 10, 13**

4,096,589 6/1978 Goldstein 2/12
4,309,775 1/1982 Jory 2/12
5,005,214 4/1991 Koethe 2/12

Primary Examiner—Raphael Barkai
Attorney, Agent, or Firm—Harold H. Dutton, Jr.

[57] **CLAIM**

The ornamental design for a eyeglass with sun shade, as shown.

DESCRIPTION

FIG. 1 is a perspective view of a eyeglass with sun shade showing my new design;
FIG. 2 is a front view thereof;
FIG. 3 is a rear view thereof;
FIG. 4 is a right side view thereof;
FIG. 5 is a left side view thereof;
FIG. 6 is a top view thereof;
FIG. 7 is a bottom view thereof; and,
FIG. 8 is a right side view thereof with the eyeglasses in the folded position and is shown without the visor for ease of illustration only; the left side view is a mirror image thereof.

[56] **References Cited**

U.S. PATENT DOCUMENTS

D. 164,304 8/1951 Houston D16/310
D. 178,984 10/1956 Black D16/310
D. 295,286 4/1988 Takeuchi D16/310
D. 308,979 7/1990 Rogers D16/310
D. 341,695 11/1993 Vandiver D16/340
D. 364,887 12/1995 Wang D16/310

1 Claim, 6 Drawing Sheets

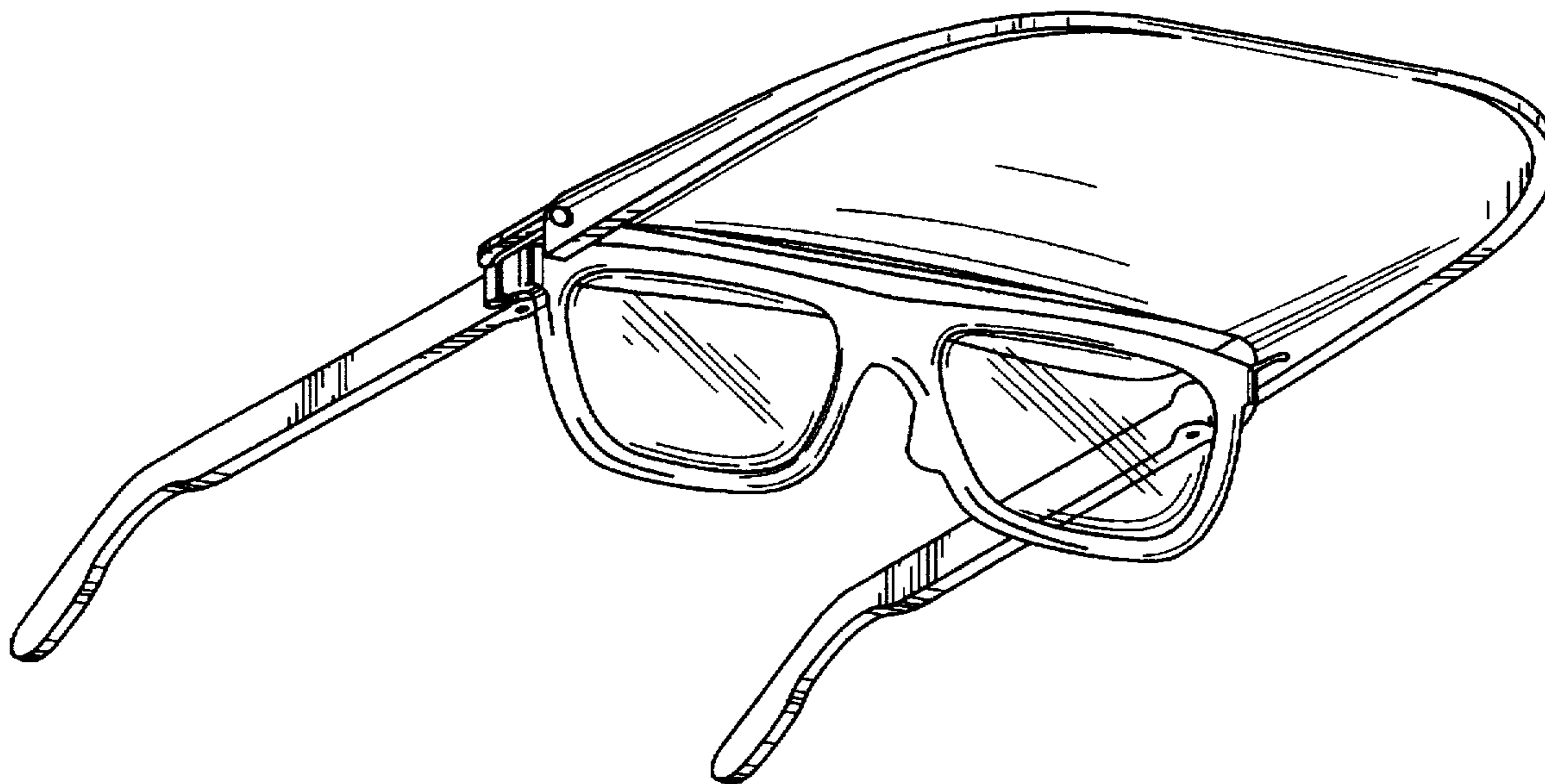

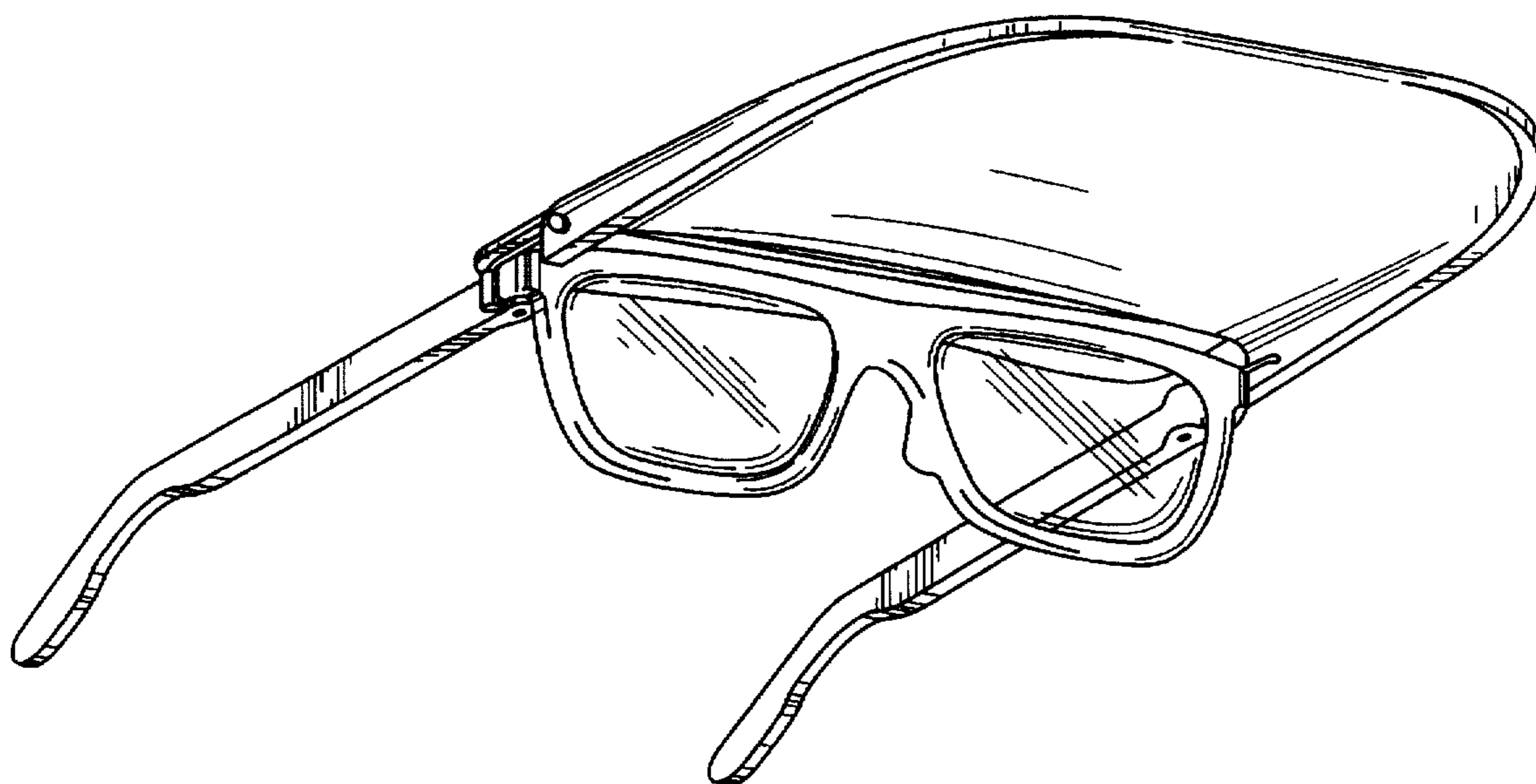

FIG. 1

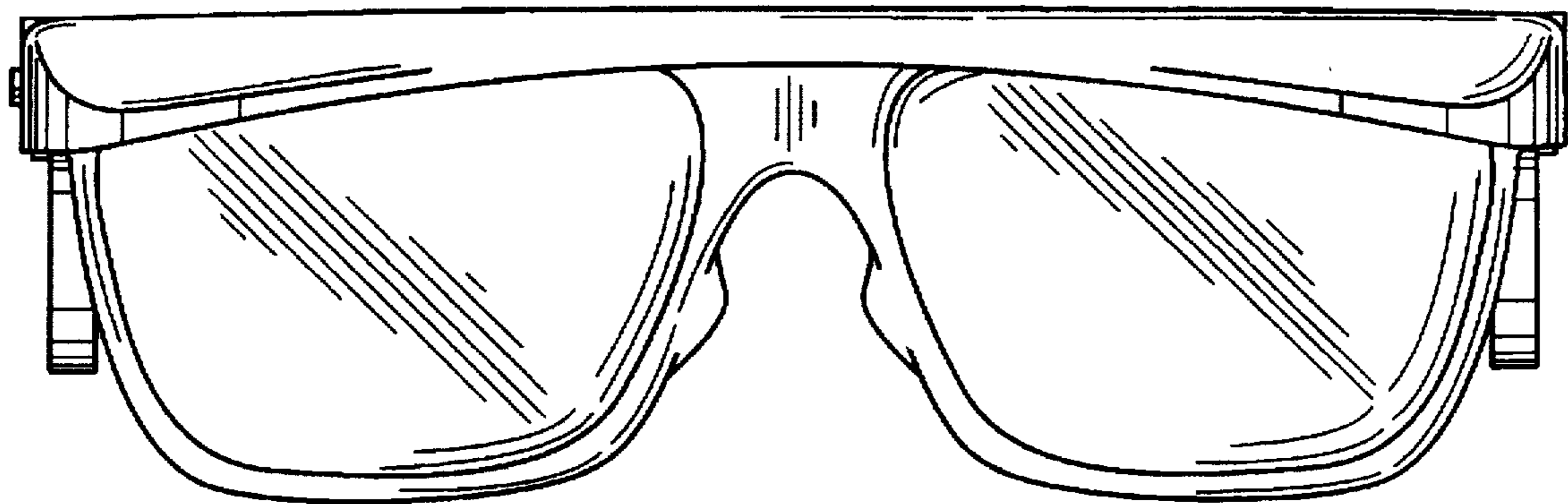

FIG. 2

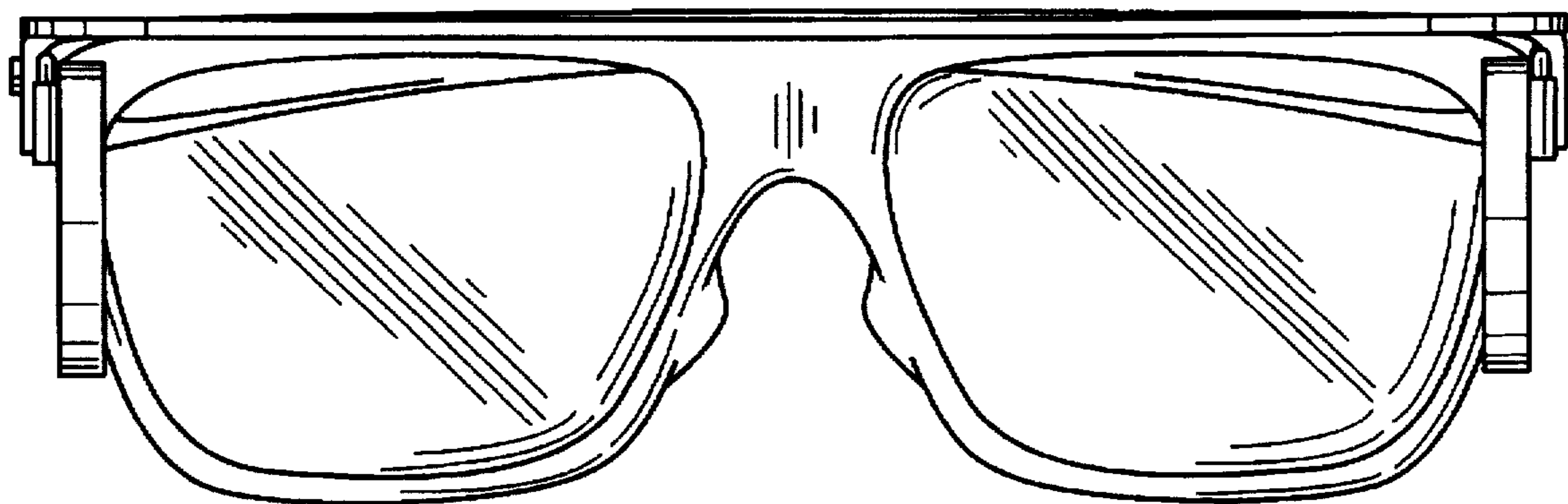

FIG. 3

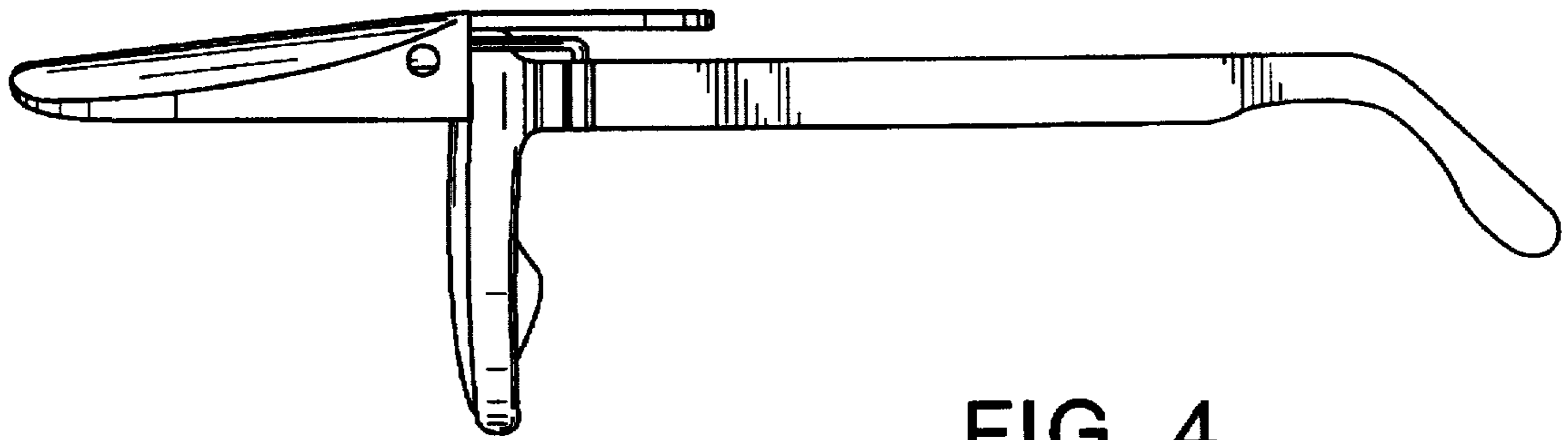

FIG. 4

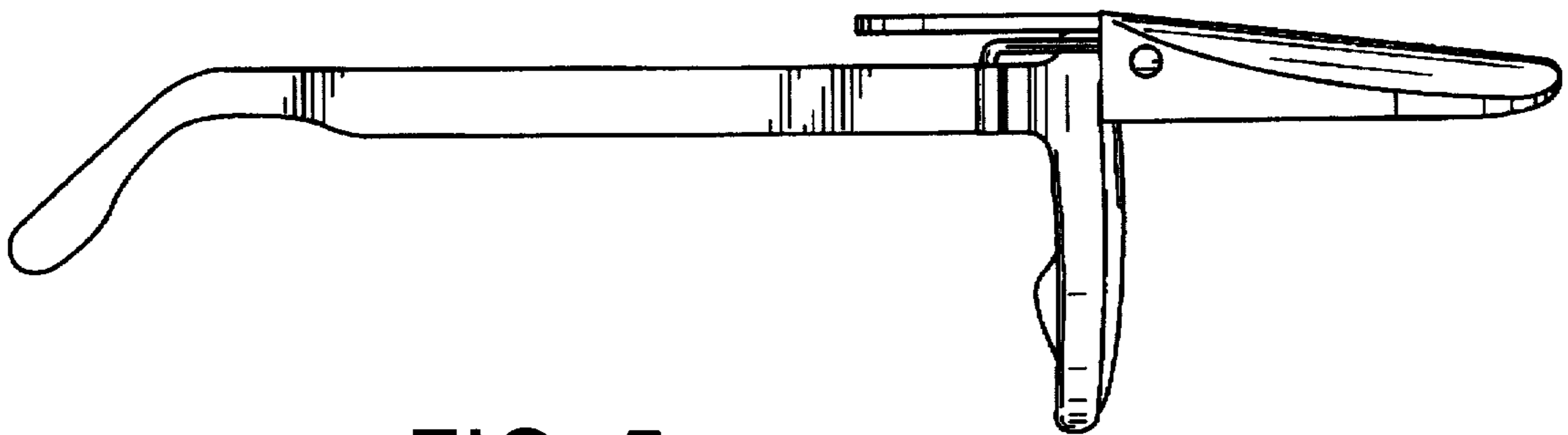

FIG. 5

FIG. 6

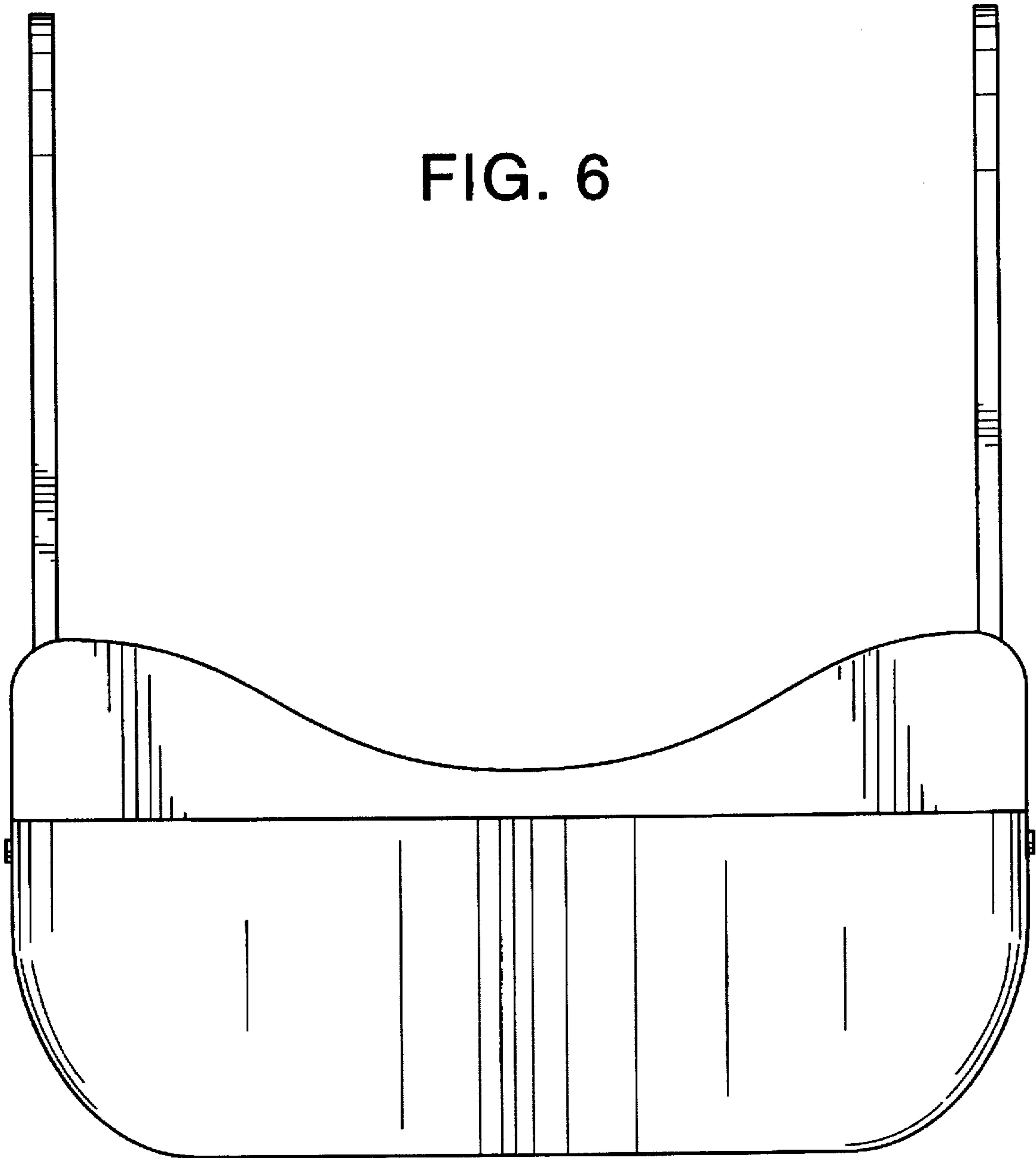
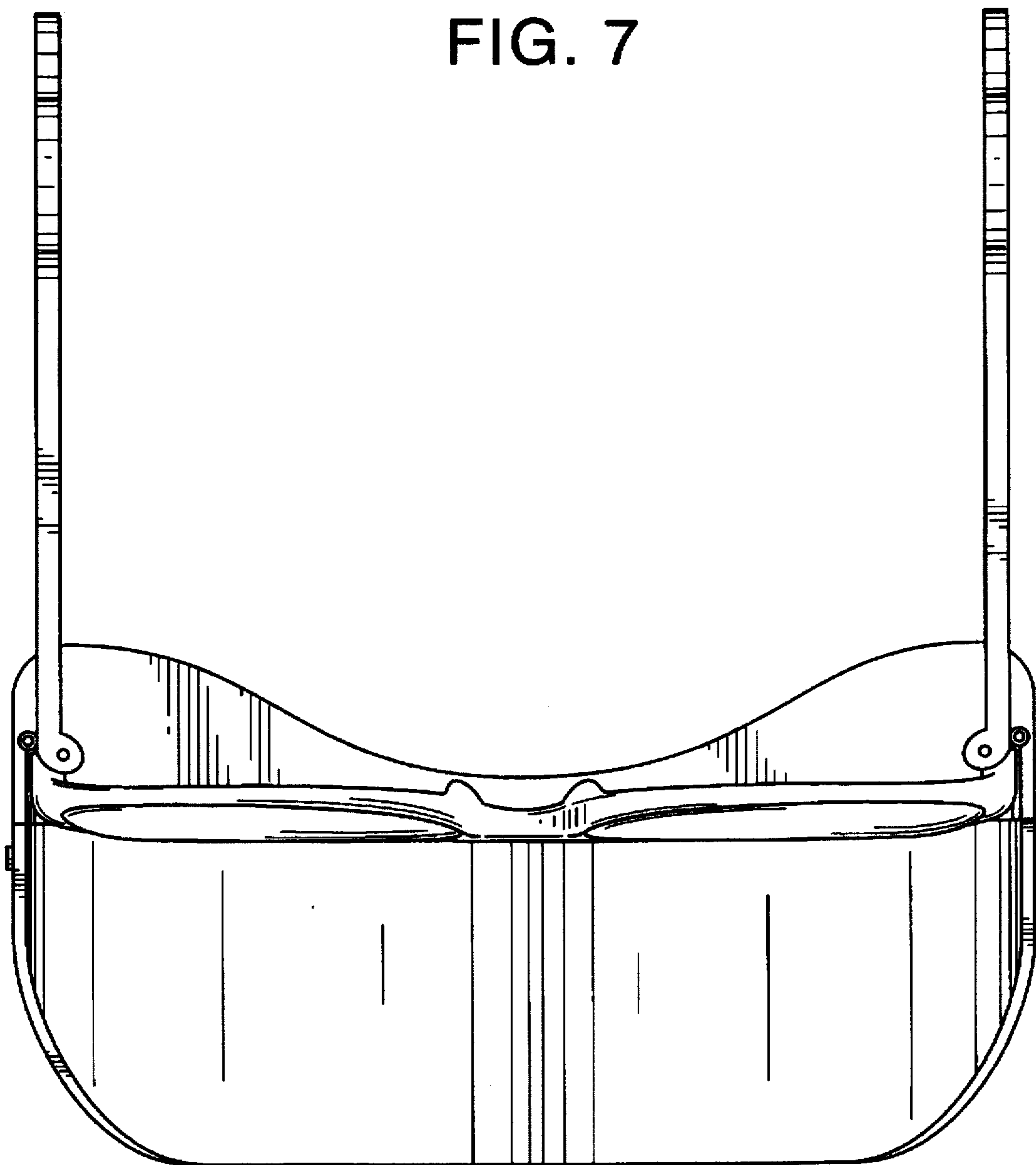

FIG. 7



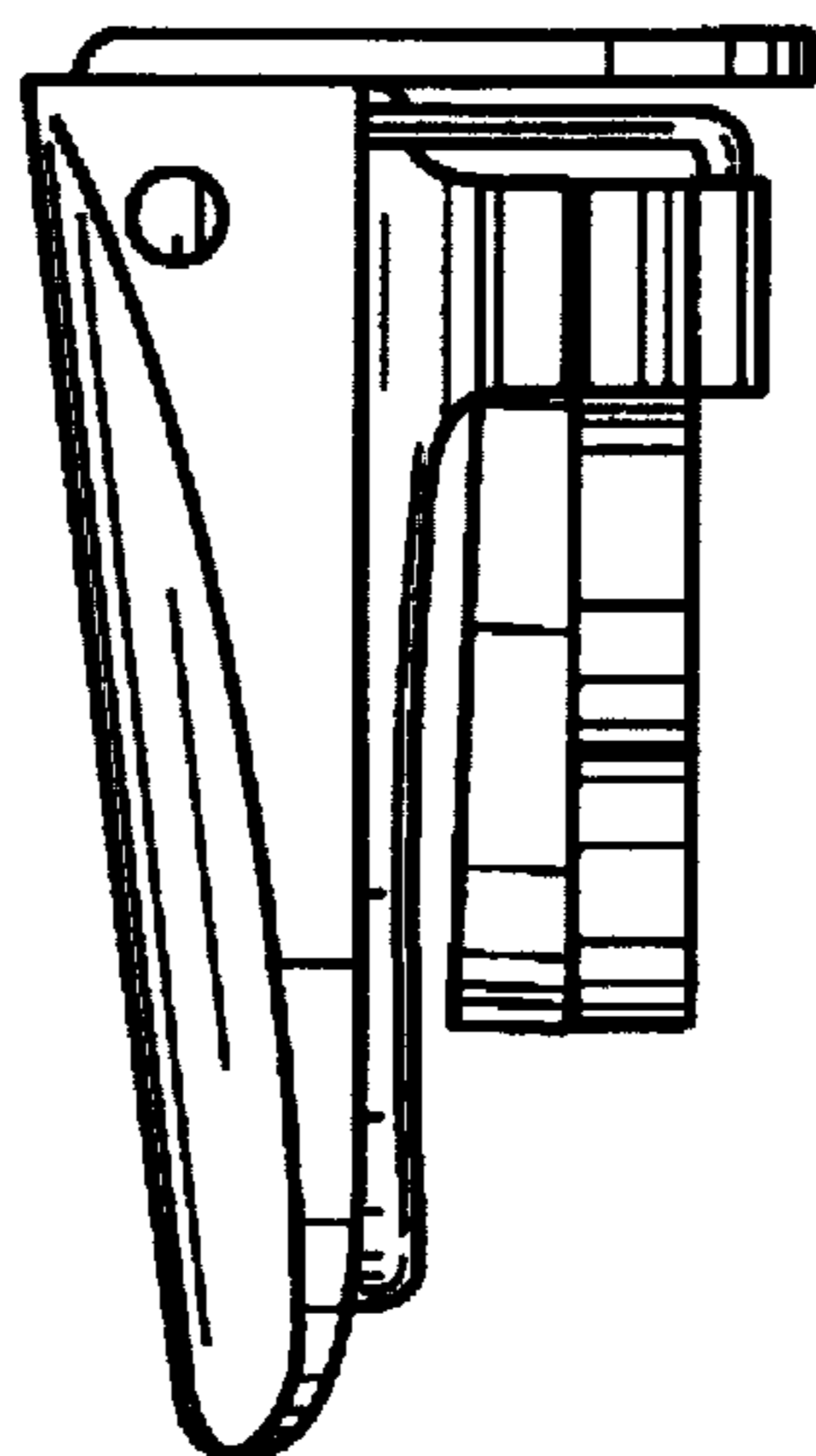

FIG. 8