

US00D385872S

**United States Patent** [19]  
**Nakamura**

[11] **Patent Number: Des. 385,872**  
[45] **Date of Patent: \*\*Nov. 4, 1997**

[54] **MAGNET OPTICAL DISC RECORDER/  
PLAYER**

[75] **Inventor: Mitsuhiro Nakamura, Tokyo, Japan**

[73] **Assignee: Sony Corporation, Tokyo, Japan**

[\*\*] **Term: 14 Years**

[21] **Appl. No.: 45,606**

[22] **Filed: Oct. 24, 1995**

[51] **LOC (6) Cl. .... 14-03**

[52] **U.S. Cl. .... D14/136; D14/107; D14/118**

[58] **Field of Search .... D14/107, 116,  
D14/118, 113, 124-125, 129, 132, 135,  
136, 156, 239, 299; D13/184; 358/342**

[56] **References Cited**

**U.S. PATENT DOCUMENTS**

- D. 337,327 7/1993 Suzuki ..... D14/136
- D. 338,003 8/1993 Nakayama ..... D14/136
- D. 364,884 12/1995 Shindo ..... D14/135 X

*Primary Examiner*—Prabhakar G. Deshmukh

*Assistant Examiner*—Richelle Shelton

*Attorney, Agent, or Firm*—Foley & Lardner

[57] **CLAIM**

The ornamental design for a magnet optical disc recorder/player, as shown and described.

**DESCRIPTION**

FIG. 1 is a perspective view of a first embodiment of the magnet optical disc recorder/player including my new design;

FIG. 2 is a top plan view thereof;

FIG. 3 is a left side elevational view thereof;

FIG. 4 is a front elevational view thereof;

FIG. 5 is a bottom plan view thereof;

FIG. 6 is a right side elevational view thereof;

FIG. 7 is a rear elevational view thereof;

FIG. 8 is a rear perspective view of the magnet optical disc recorder/player wherein the stand thereof is in the open position;

FIG. 9 is a perspective view thereof (the hand and paper portions are shown in broken lines for illustrative purposes only and forms no part of the claimed invention);

FIG. 10 is a perspective view of another embodiment of the magnet optical disc recorder/player;

FIG. 11 is a top plan view of the embodiment of FIG. 10;

FIG. 12 is a left side elevational view of the embodiment of FIG. 10;

FIG. 13 is a front elevational view of the embodiment of FIG. 10;

FIG. 14 is a right side elevational view of the embodiment of FIG. 10; and,

FIG. 15 is a rear elevational view of the embodiment of FIG. 10.

The bottom plan view of the embodiment of FIG. 10 is shown in FIG. 5.

**1 Claim, 7 Drawing Sheets**

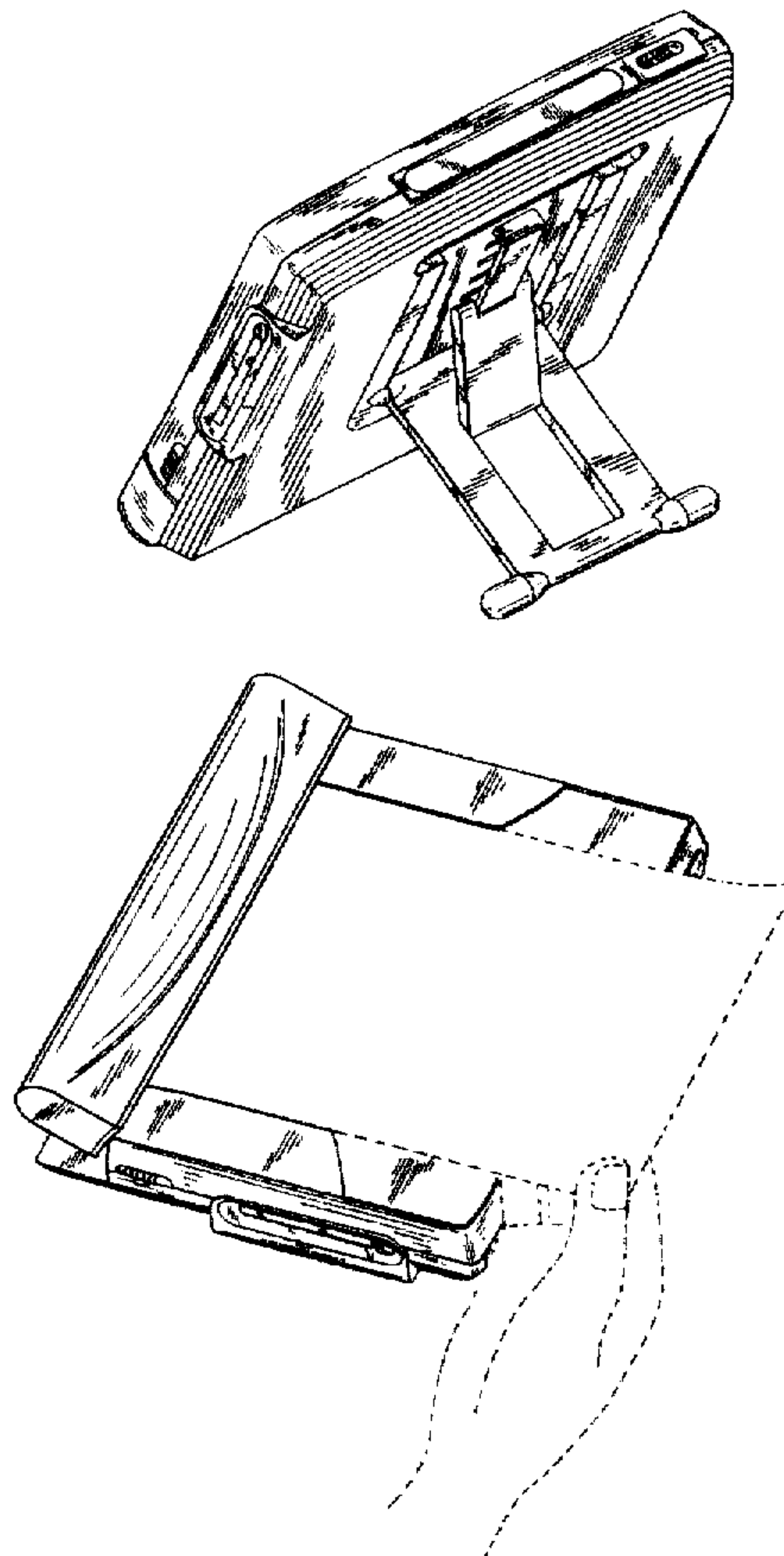

FIG. 1

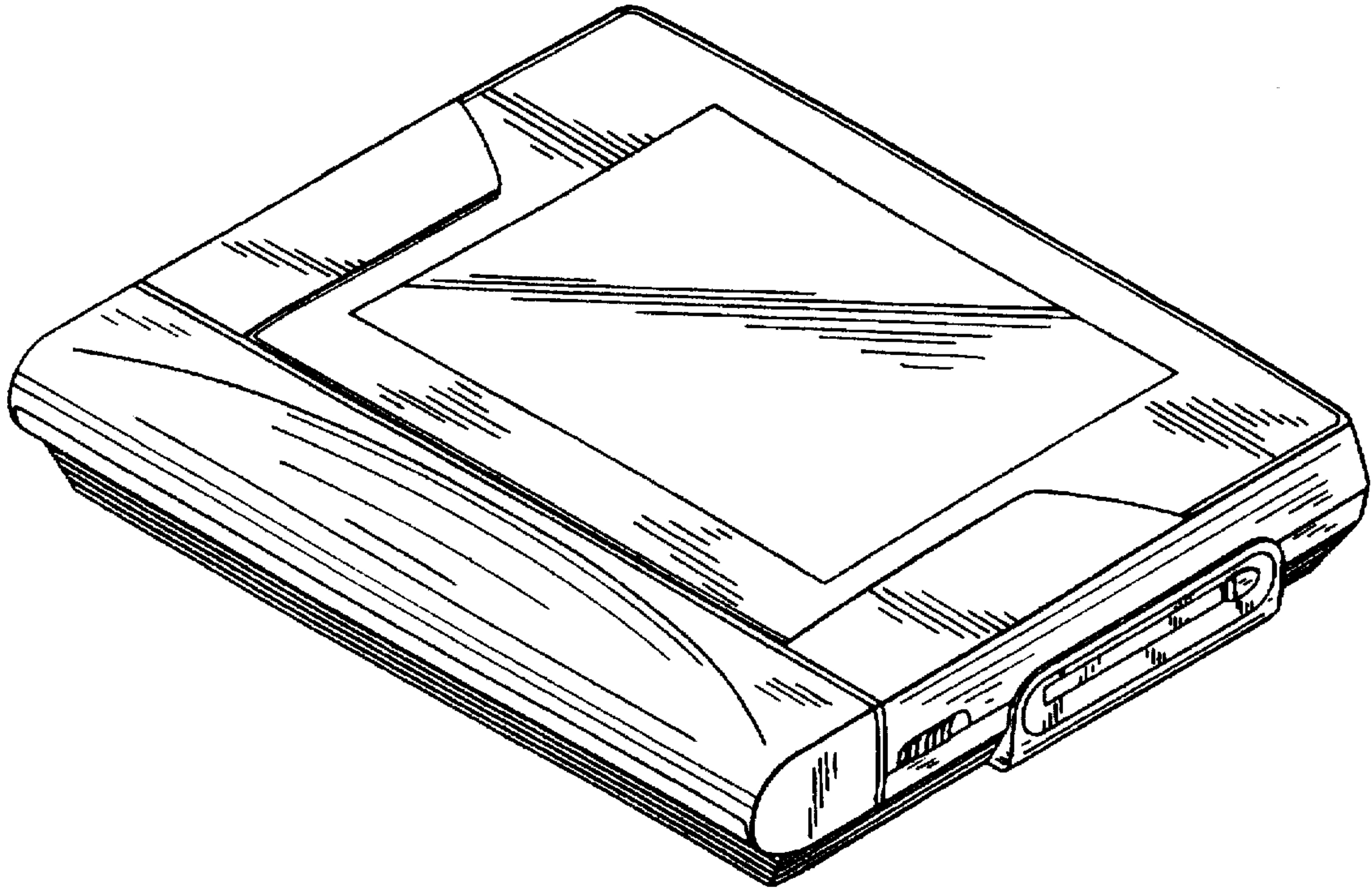

FIG. 2

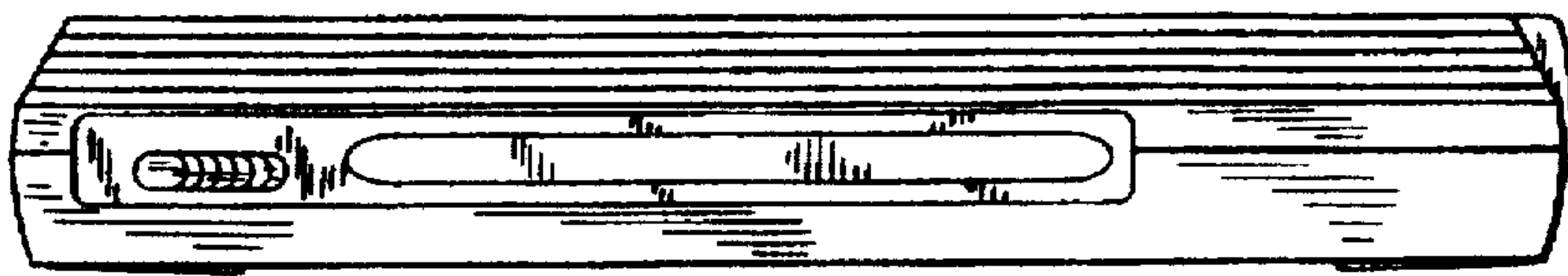

FIG. 5

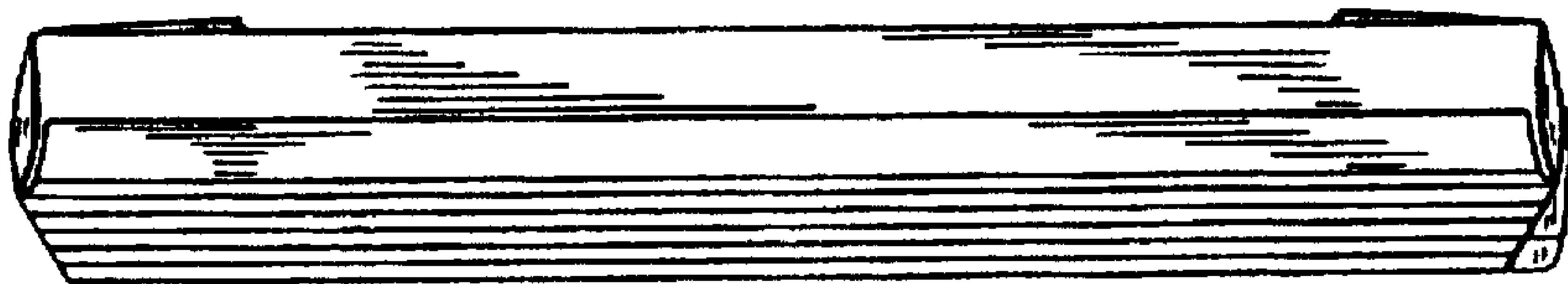

FIG. 4

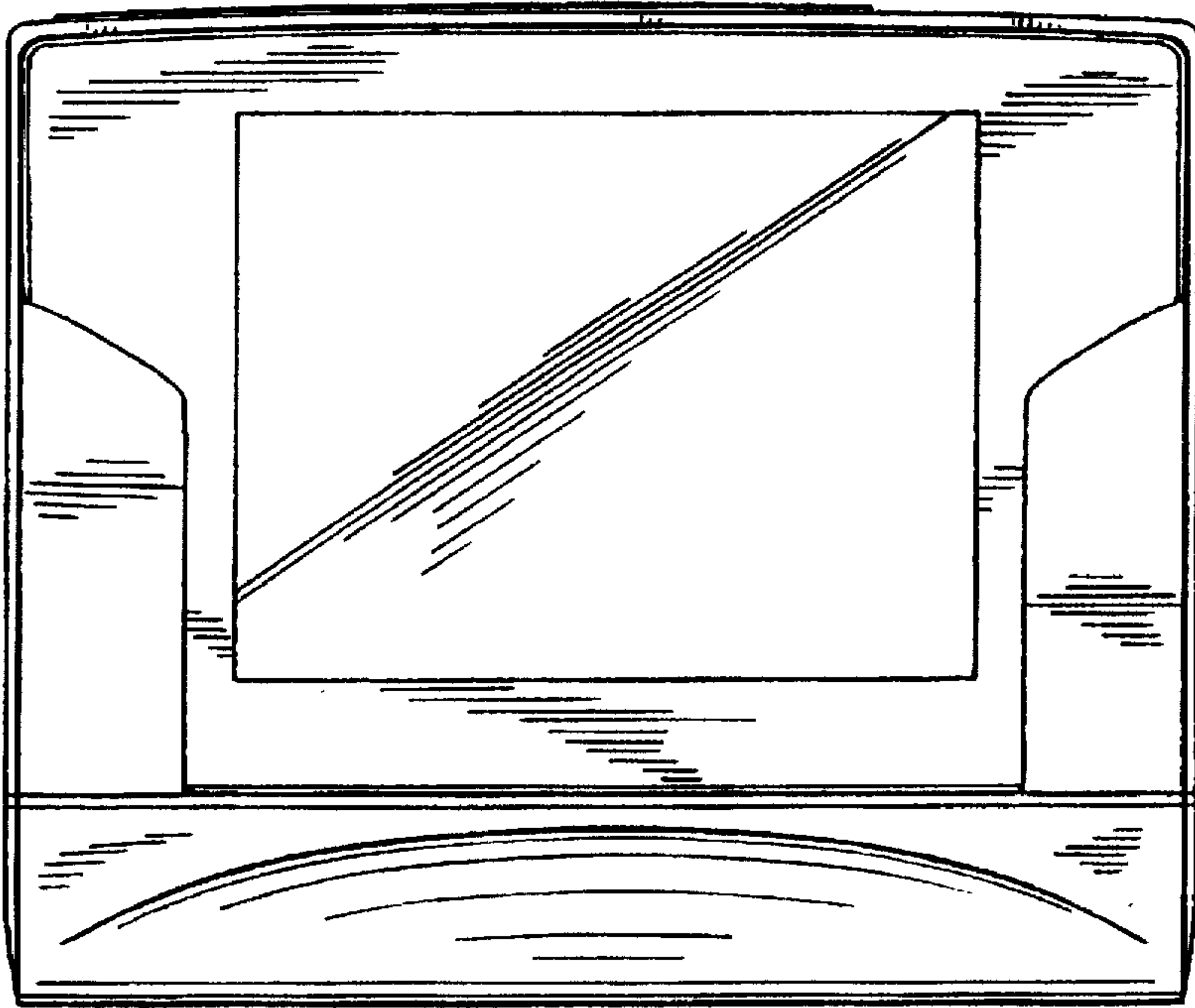

FIG. 3

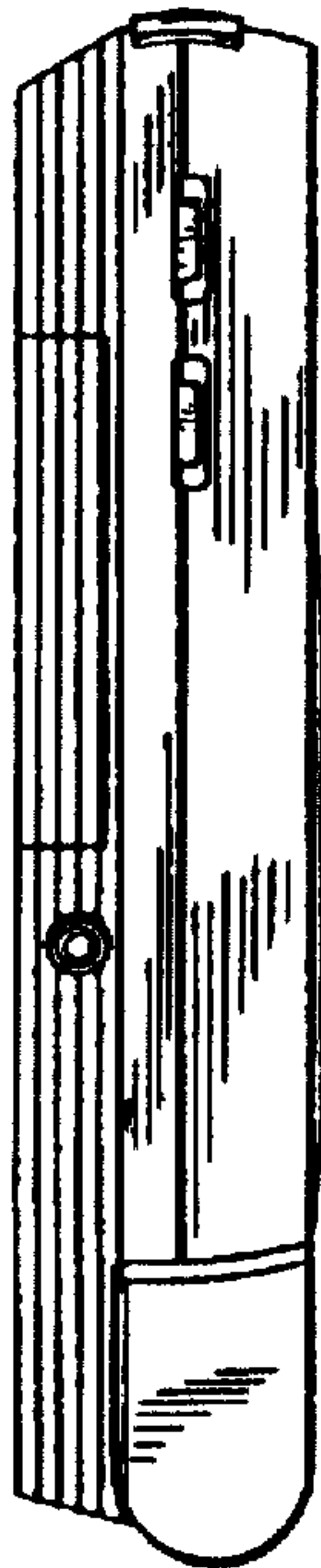

FIG. 6

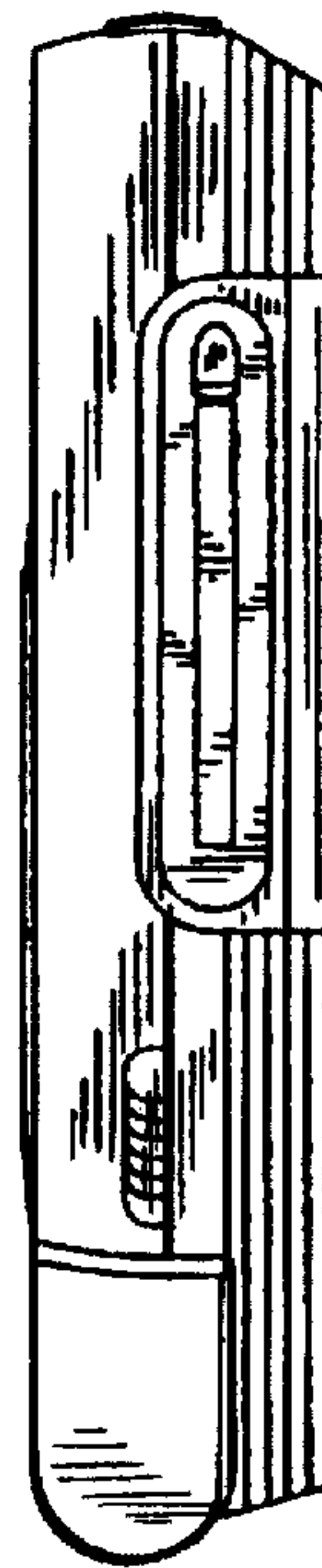



FIG. 7

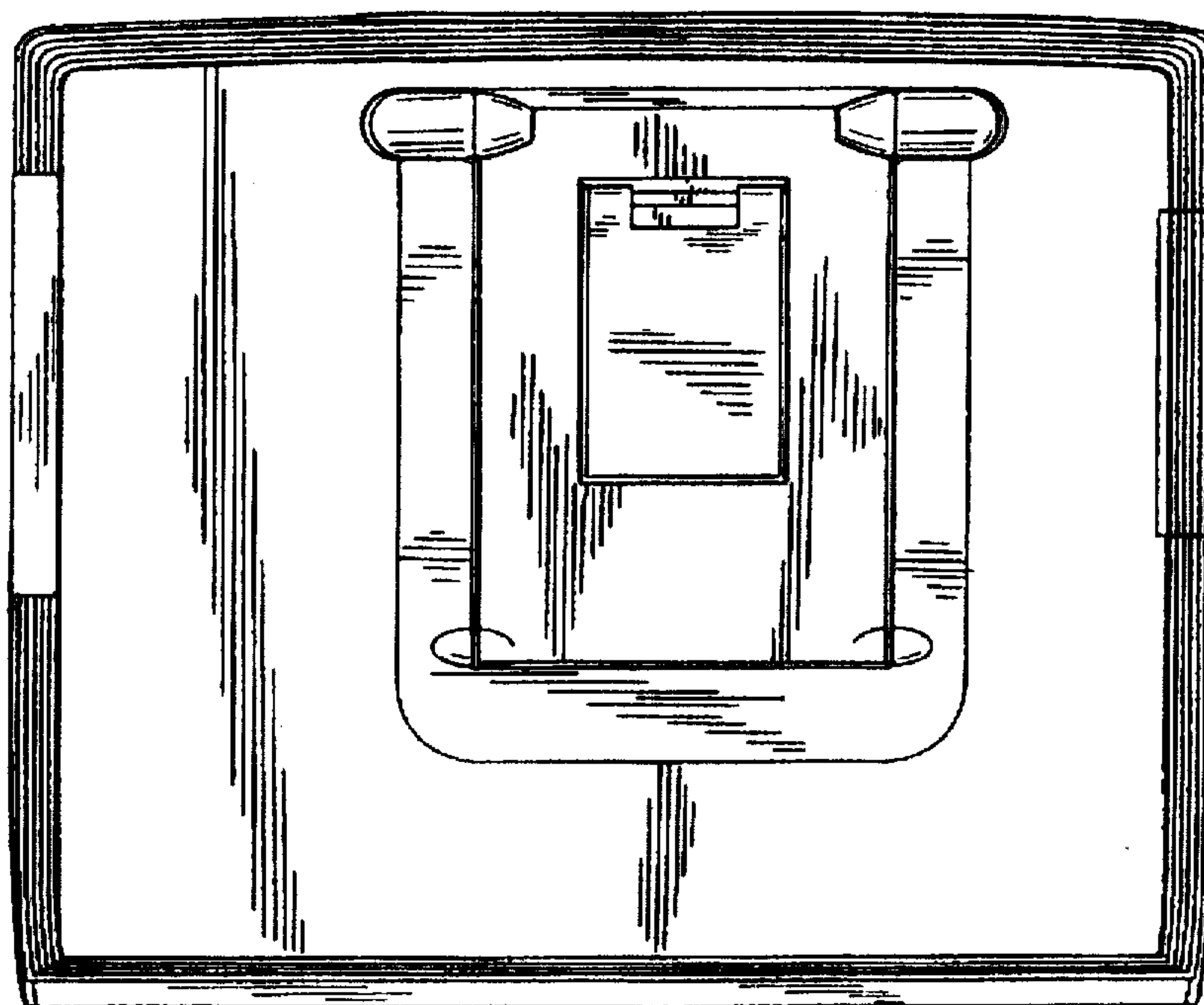

FIG. 8

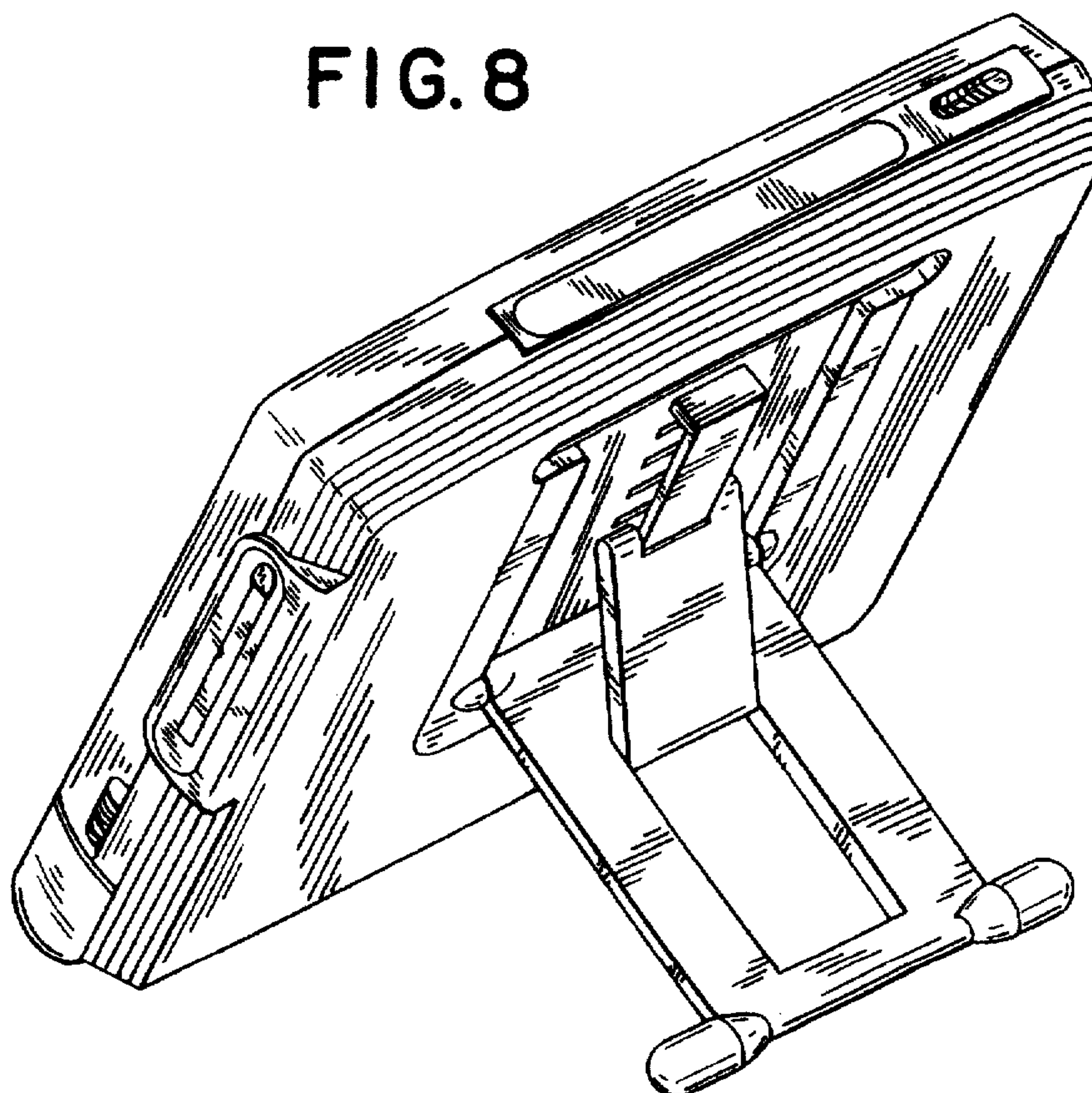

FIG. 9

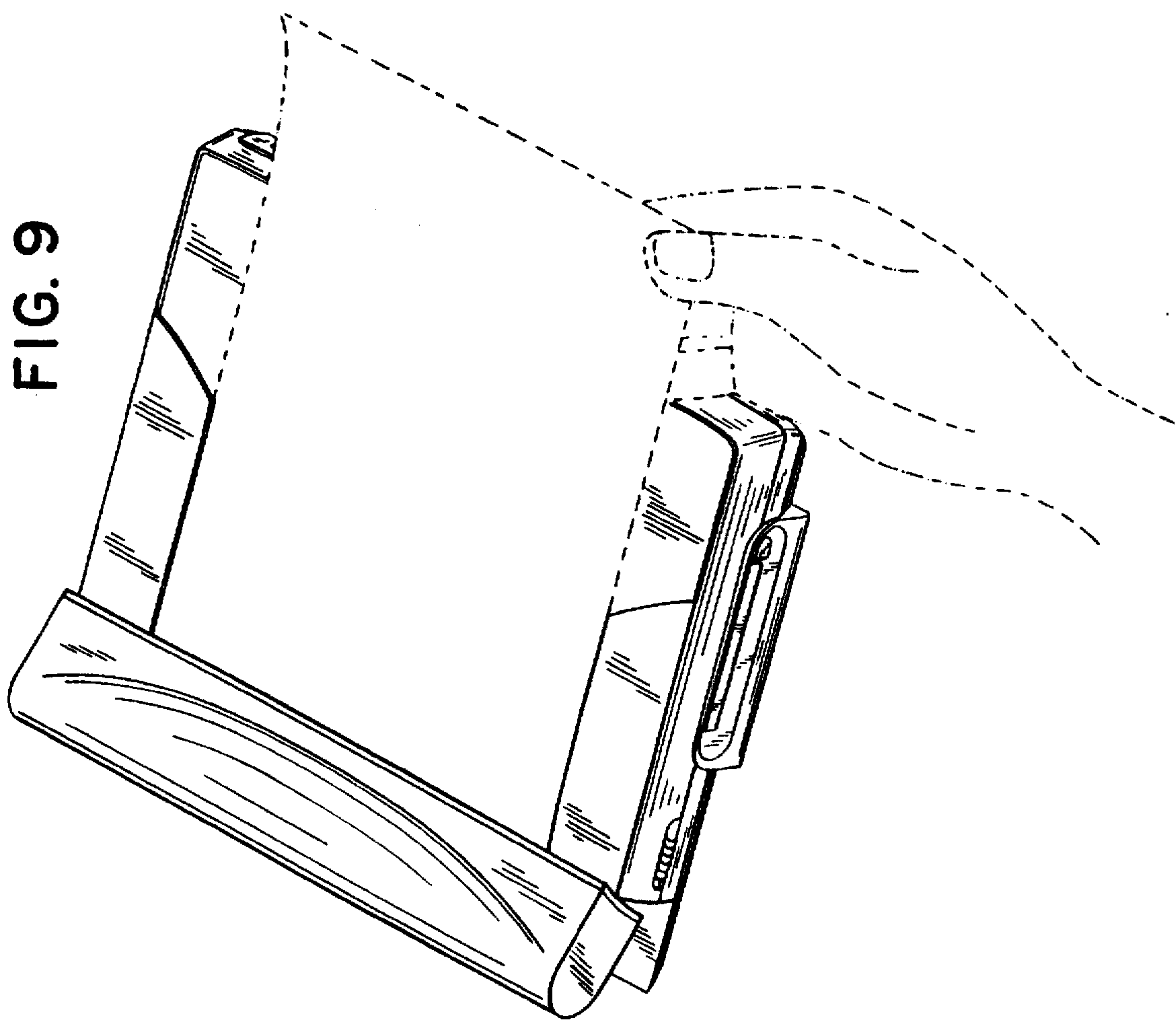

FIG. 10

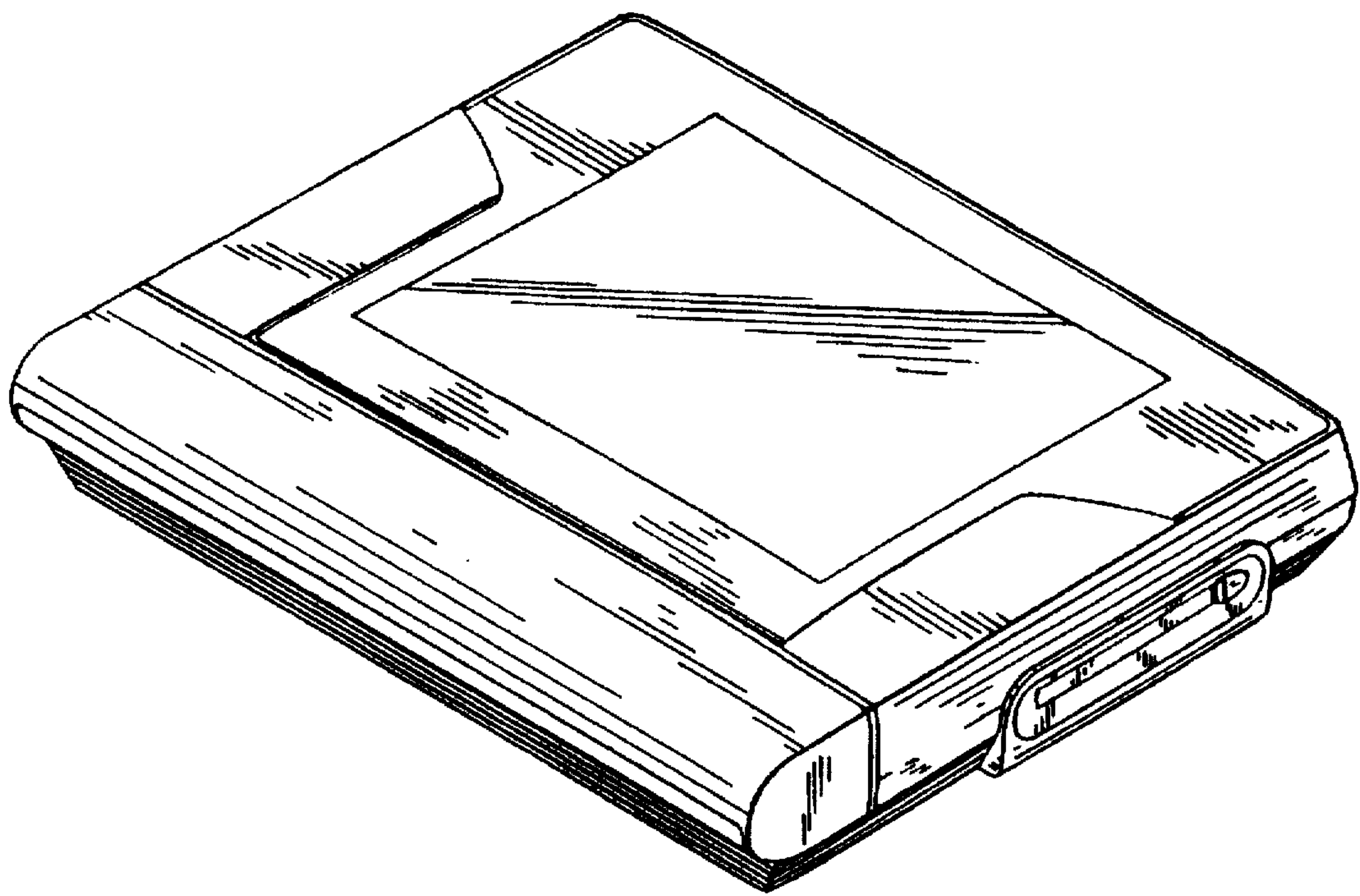

FIG. 13

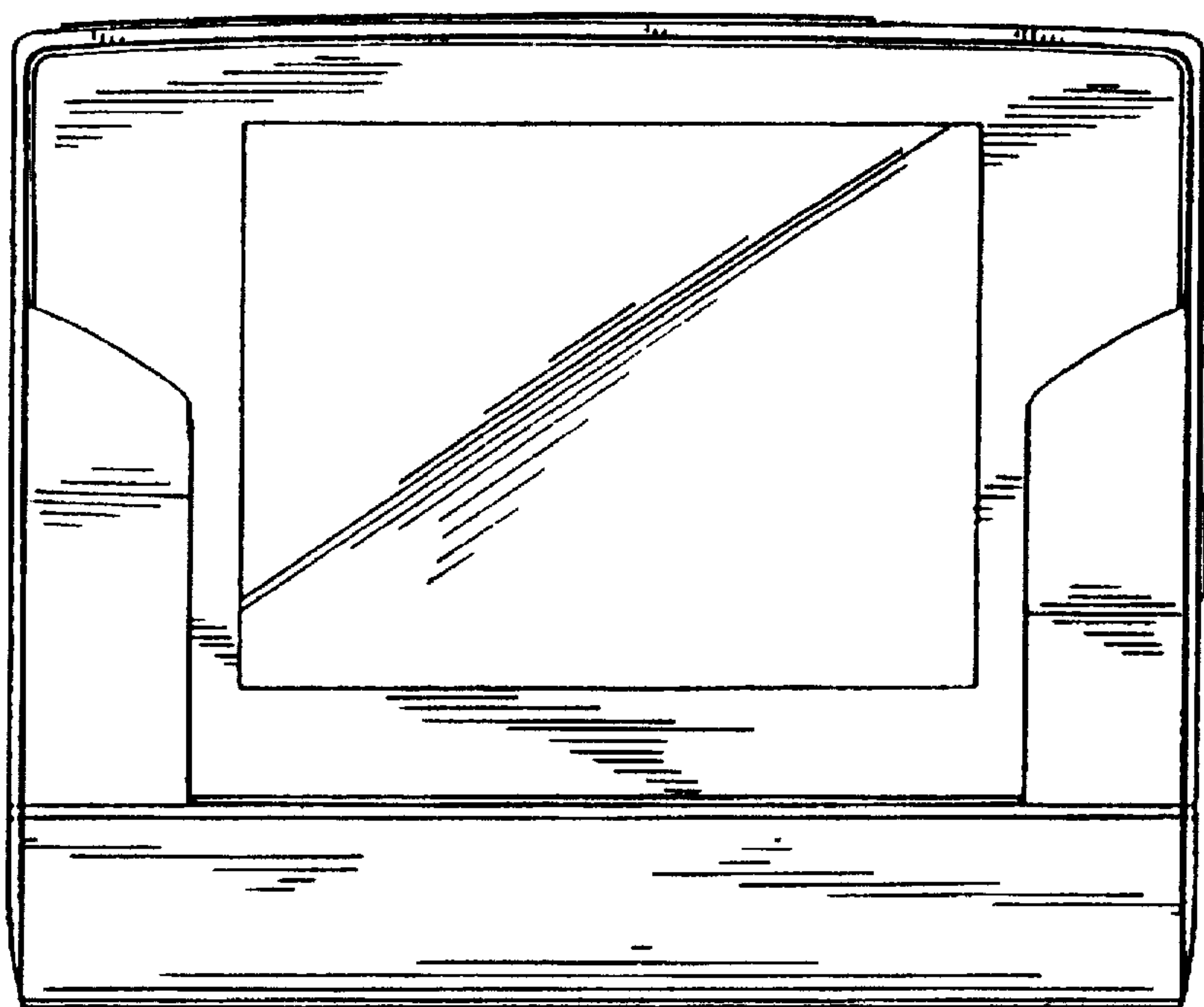

FIG. 11

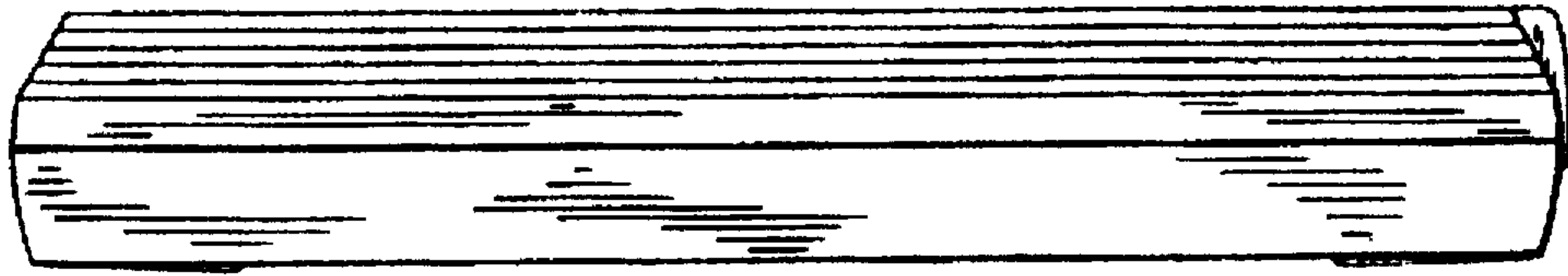

FIG. 12

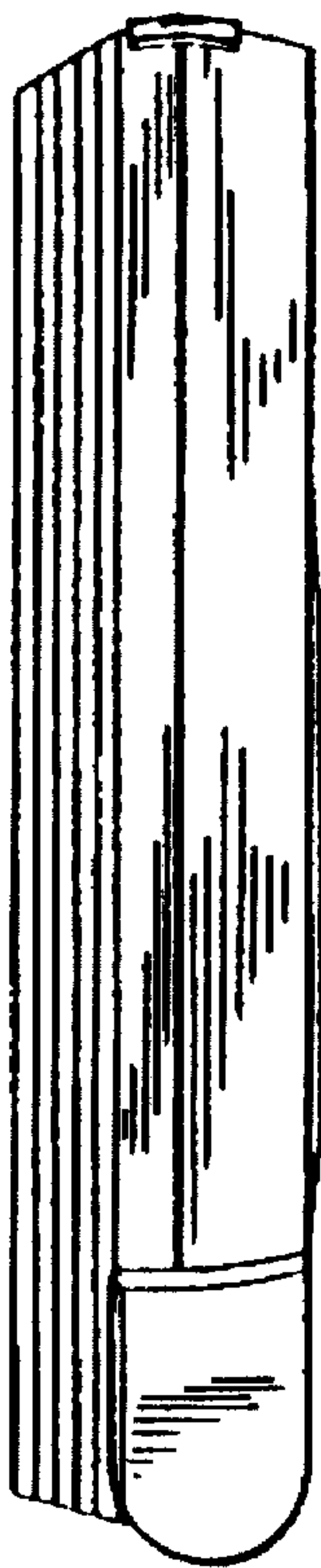

FIG. 14

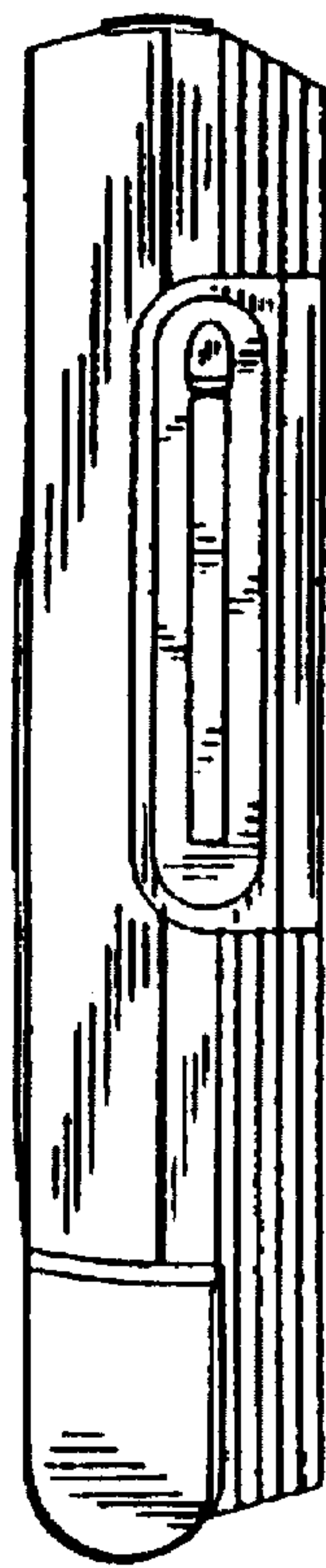

FIG. 15

