



US00D385856S

# United States Patent [19]

Kawa

[11] Patent Number: **Des. 385,856**

[45] Date of Patent: **\*\*Nov. 4, 1997**

[54] **PERSONAL COMPUTER**

[75] Inventor: **Mitsuo Kawa, Nara, Japan**

[73] Assignee: **Sharp Kabushiki Kaisha, Osaka, Japan**

[\*\*] Term: **14 Years**

[21] Appl. No.: **61,249**

[22] Filed: **Oct. 18, 1996**

[30] **Foreign Application Priority Data**

Apr. 19, 1996 [JP] Japan ..... 811441

[51] **LOC (6) Cl.** ..... **14-02**

[52] **U.S. Cl.** ..... **D14/106**

[58] **Field of Search** ..... D14/100, 101,  
D14/106, 113, 115; D18/1, 2, 7; 235/145 A,  
145 R; 341/22, 23; 345/104, 156, 168,  
173, 901, 905; 361/680-686; 364/708.1;  
400/486, 489

[56] **References Cited**

**U.S. PATENT DOCUMENTS**

- D. 330,016 10/1992 Mizusugi et al. .
- D. 334,182 3/1993 Mizusugi et al. .
- D. 335,124 4/1993 Mizusugi et al. .
- D. 338,880 8/1993 Mizusugi et al. .
- D. 339,114 9/1993 Mizusugi et al. .
- D. 340,921 11/1993 Mizusugi et al. .
- D. 343,167 1/1994 Mizusugi et al. .

- D. 344,496 2/1994 Mizusugi et al. .
- D. 355,170 2/1995 Mizusugi et al. .
- D. 357,674 4/1995 Mizusugi .
- D. 361,553 8/1995 De Iuliis ..... D14/106
- D. 367,046 2/1996 Haraga et al. .... D14/106

*Primary Examiner*—Freda Nunn  
*Attorney, Agent, or Firm*—Nixon & Vanderhye

[57] **CLAIM**

The ornamental design for a "personal computer", as shown and described.

**DESCRIPTION**

FIG. 1 is a top, front and right side perspective view of a personal computer according to my design;  
 FIG. 2 is a front elevational view thereof;  
 FIG. 3 is a top plan view thereof;  
 FIG. 4 is a rear elevational view thereof;  
 FIG. 5 is a bottom plan view thereof;  
 FIG. 6 is a right side elevational view thereof;  
 FIG. 7 is a left side elevational view thereof;  
 FIG. 8 is a front elevational view thereof in a closed position;  
 FIG. 9 is a top plan view thereof;  
 FIG. 10 is a rear elevational view thereof;  
 FIG. 11 is a bottom plan view thereof;  
 FIG. 12 is a right side elevational view thereof; and,  
 FIG. 13 is a left side elevational view thereof.

**1 Claim, 6 Drawing Sheets**

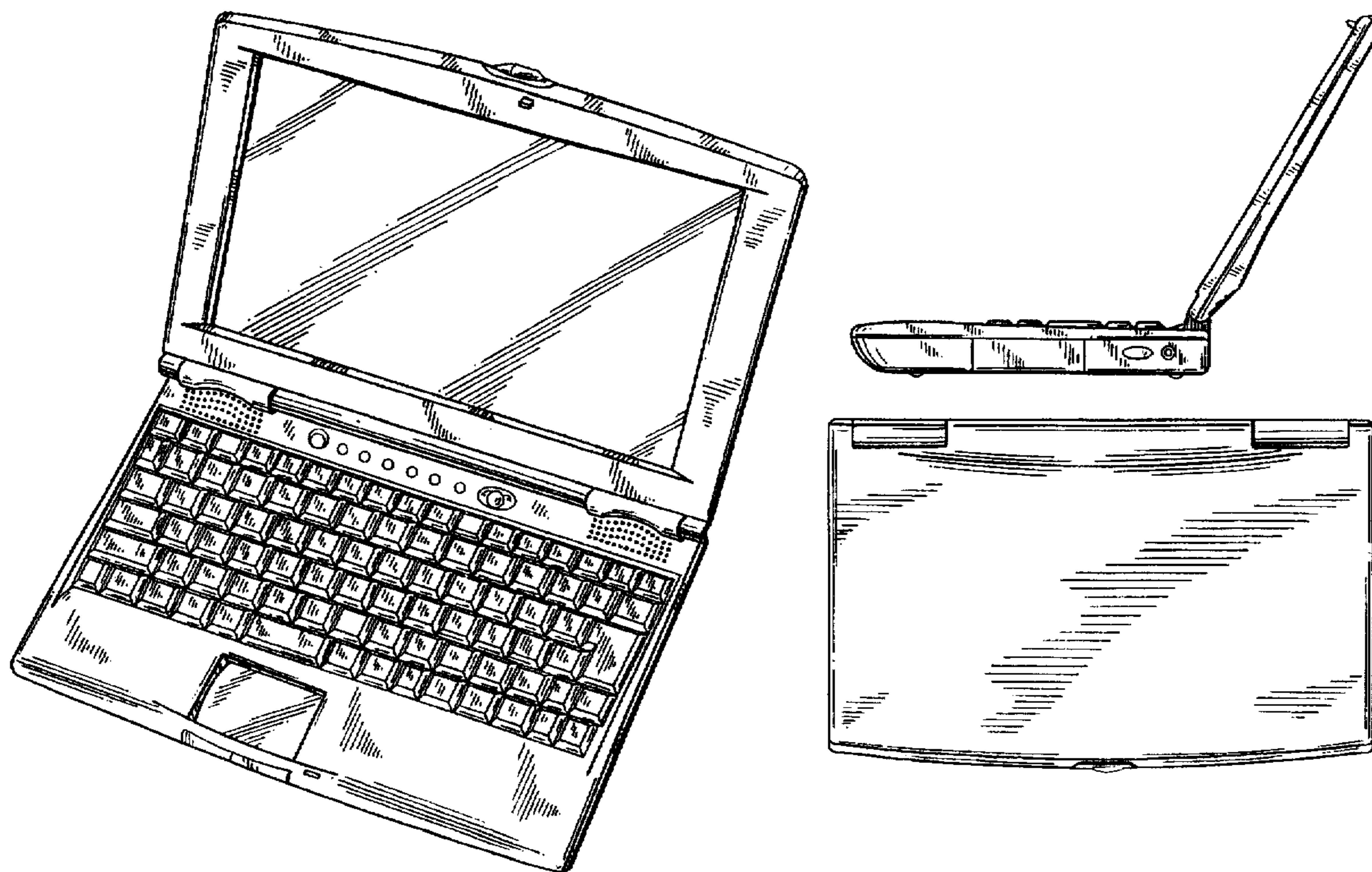

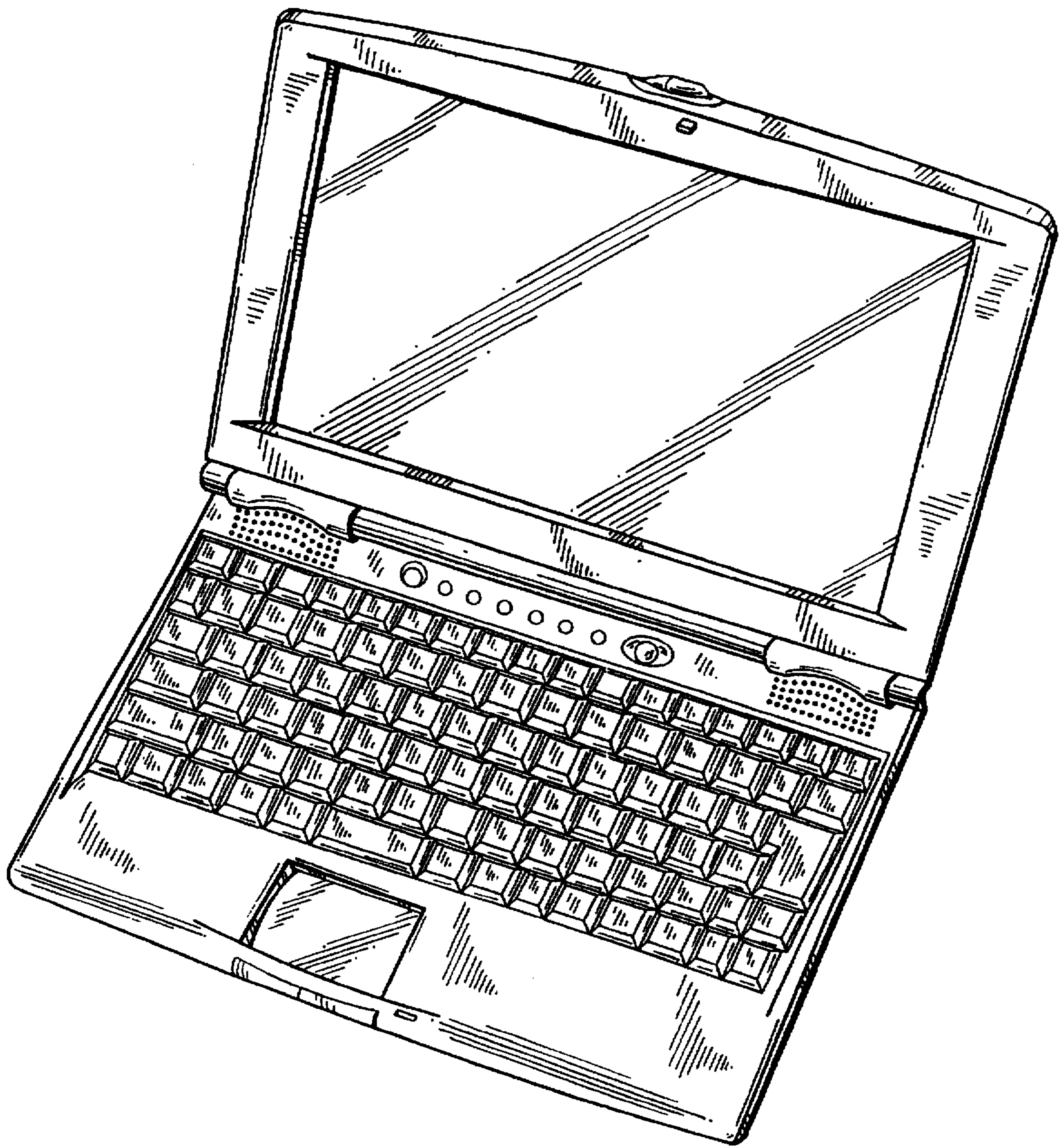

FIG. 1

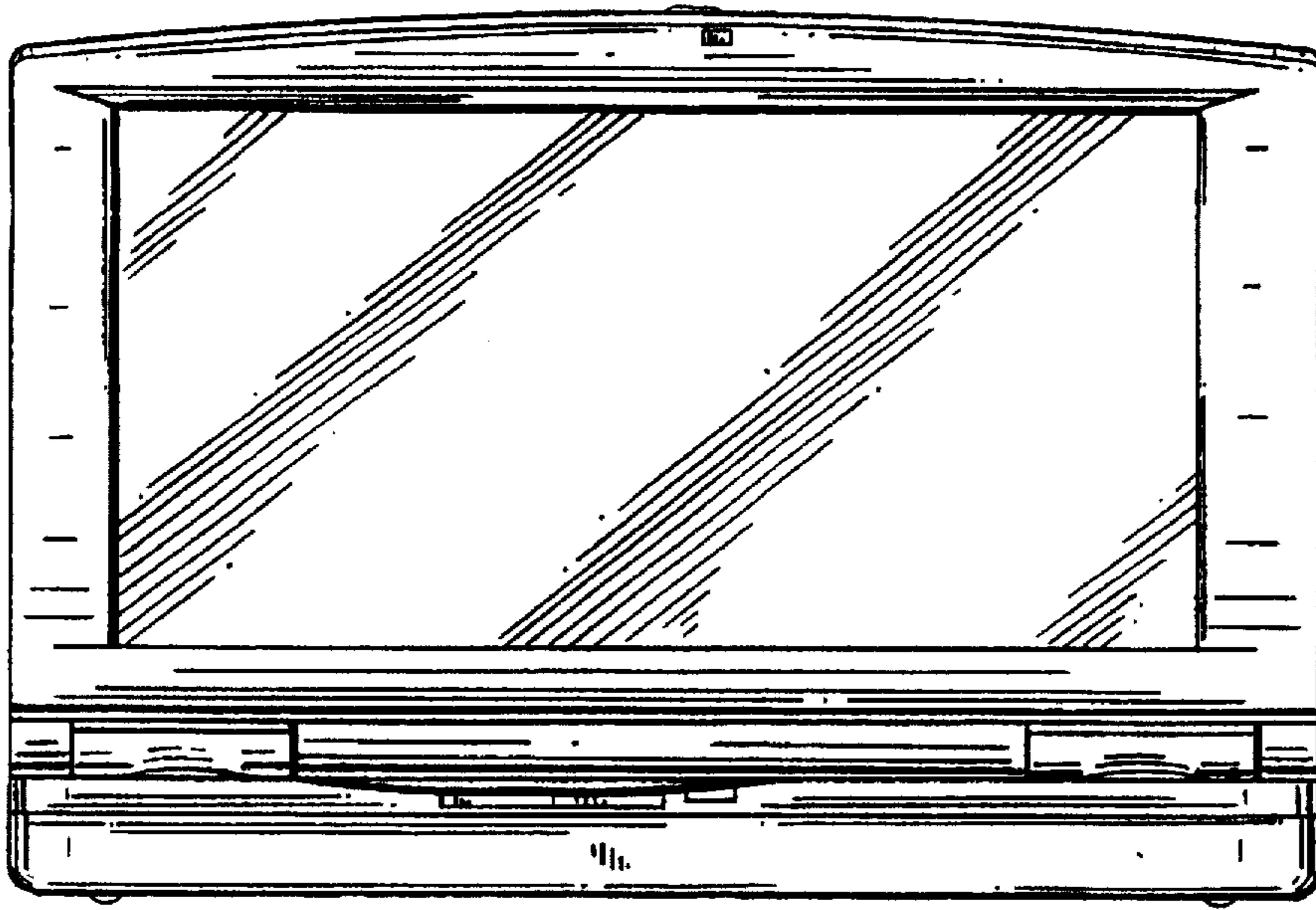

FIG. 2

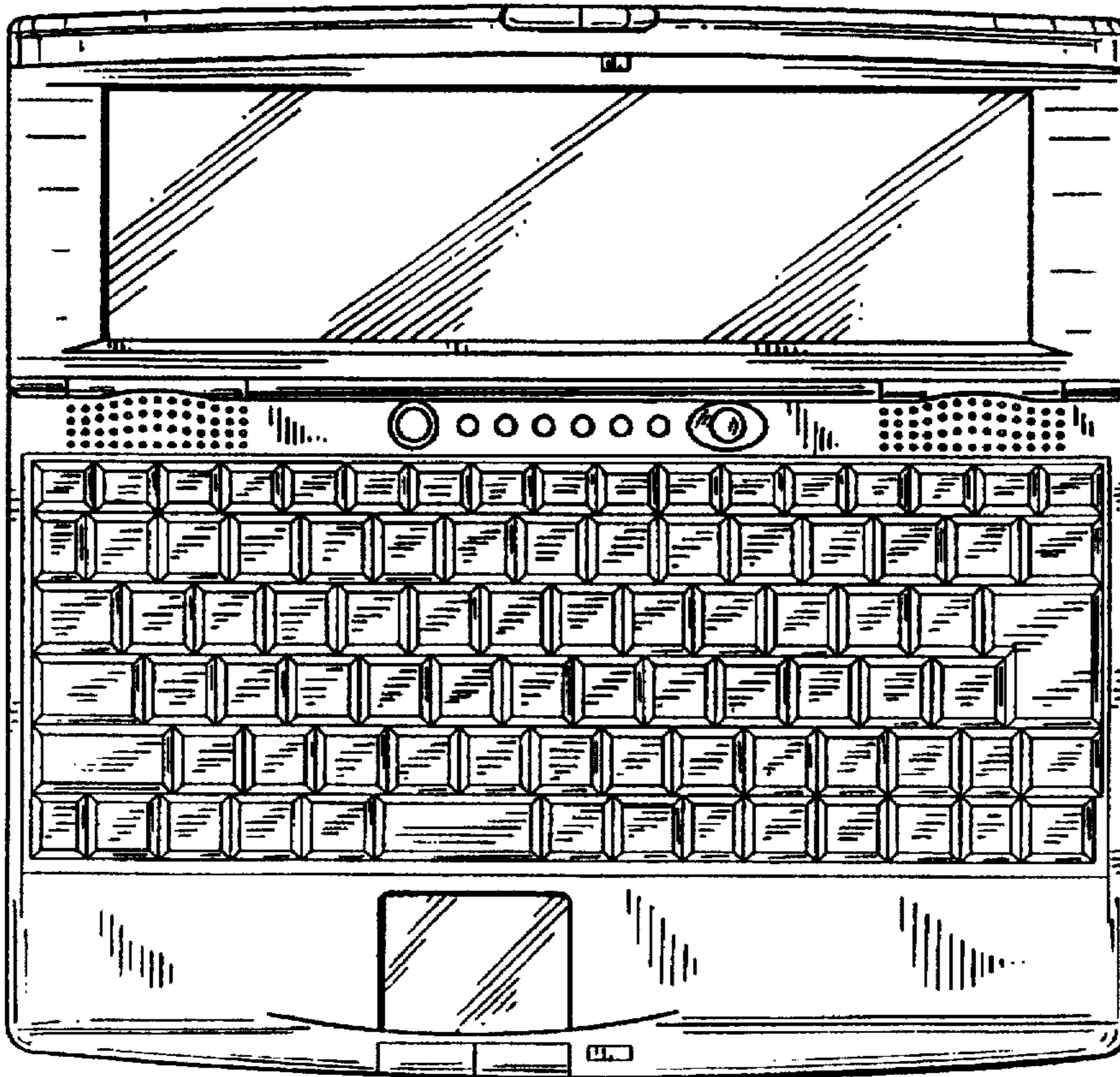

FIG. 3

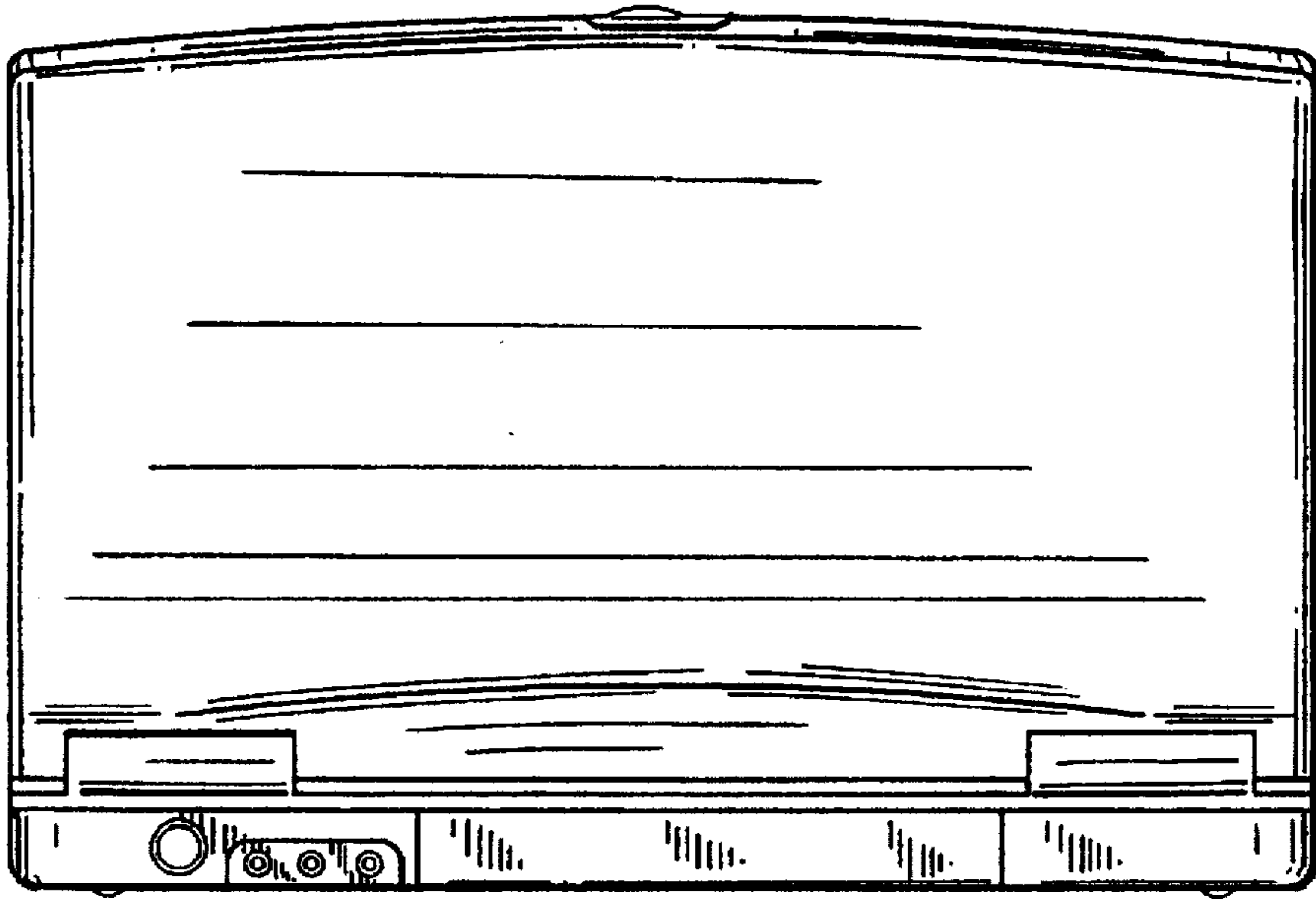

FIG. 4

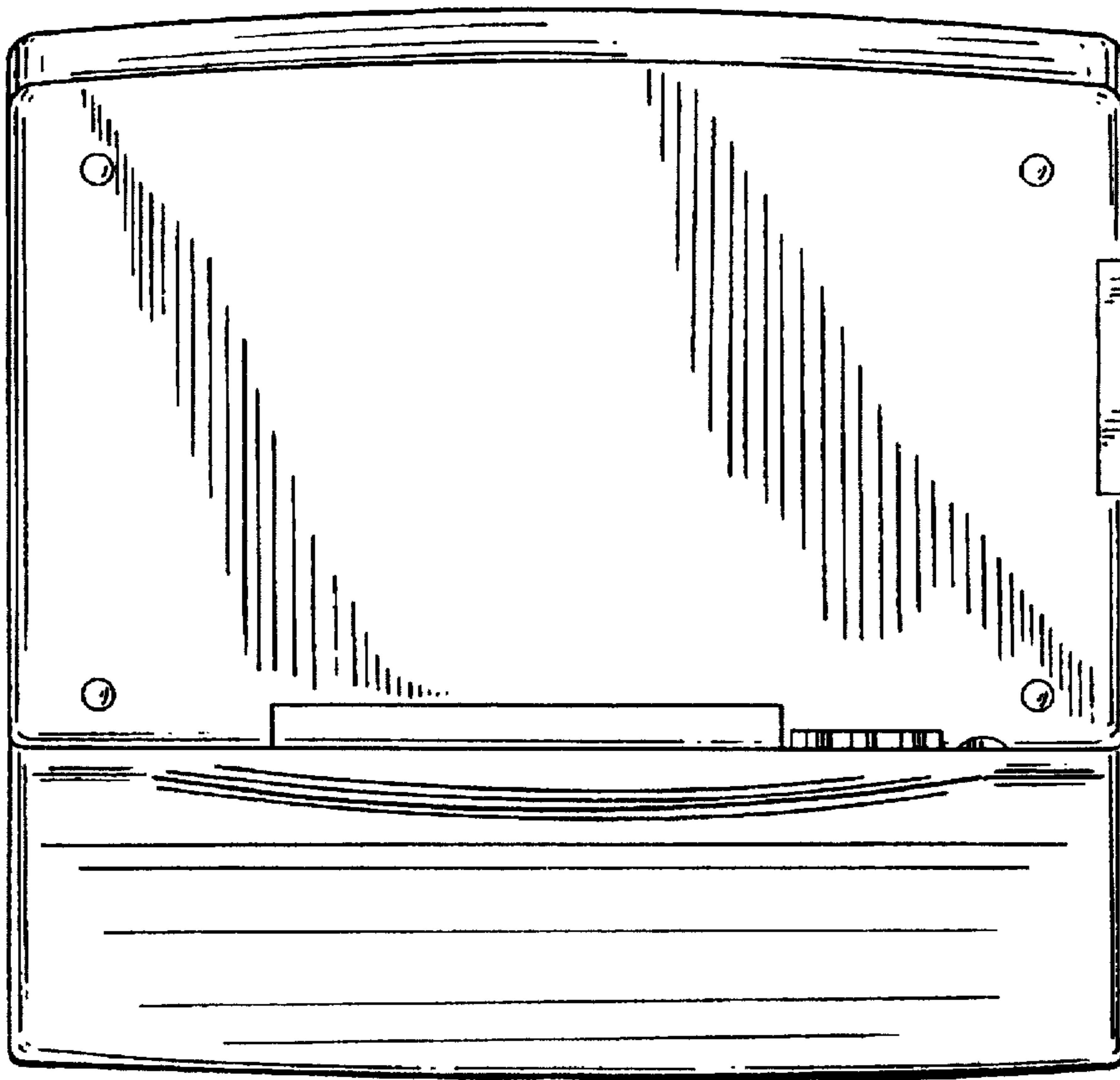

FIG. 5

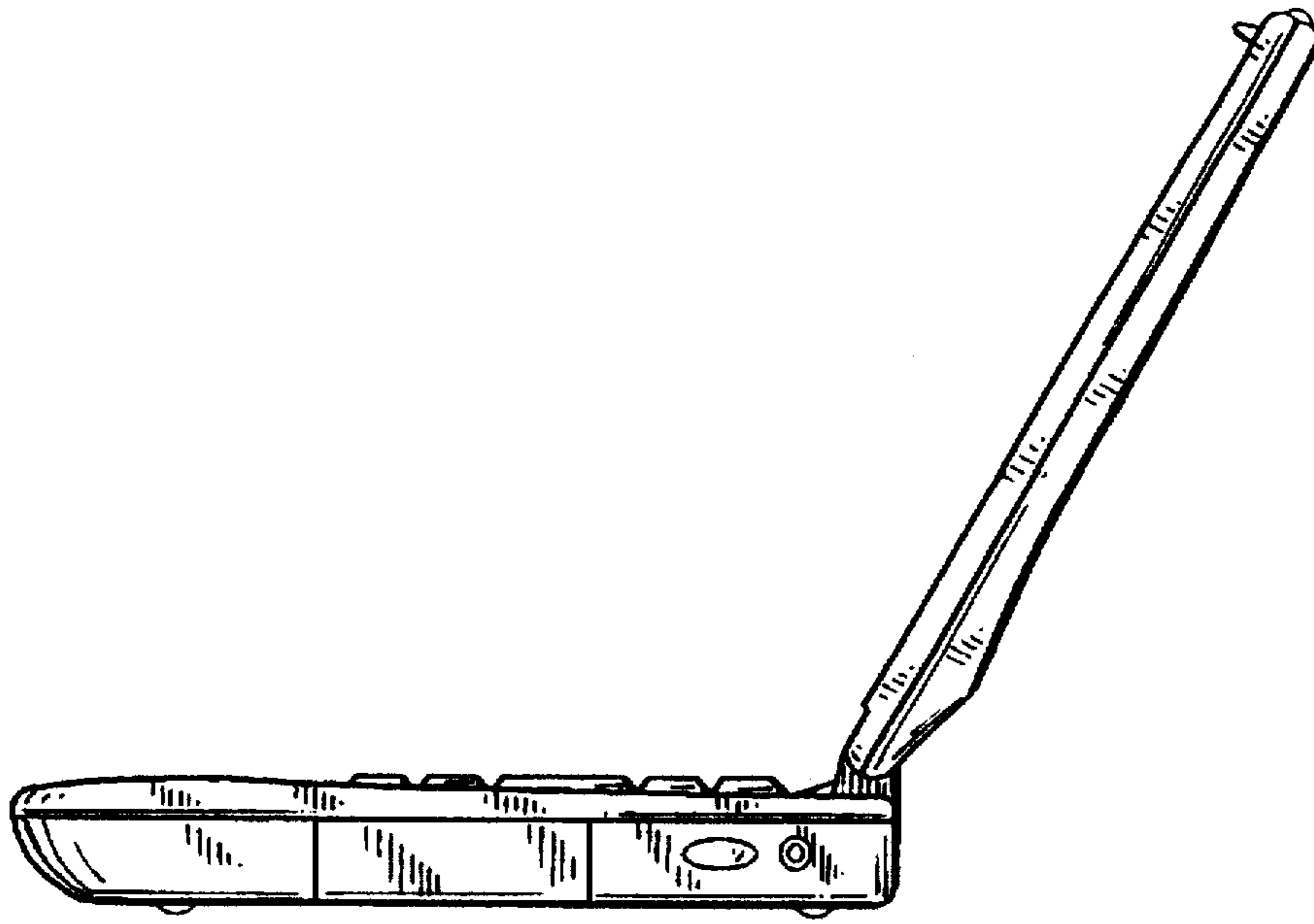

FIG. 6

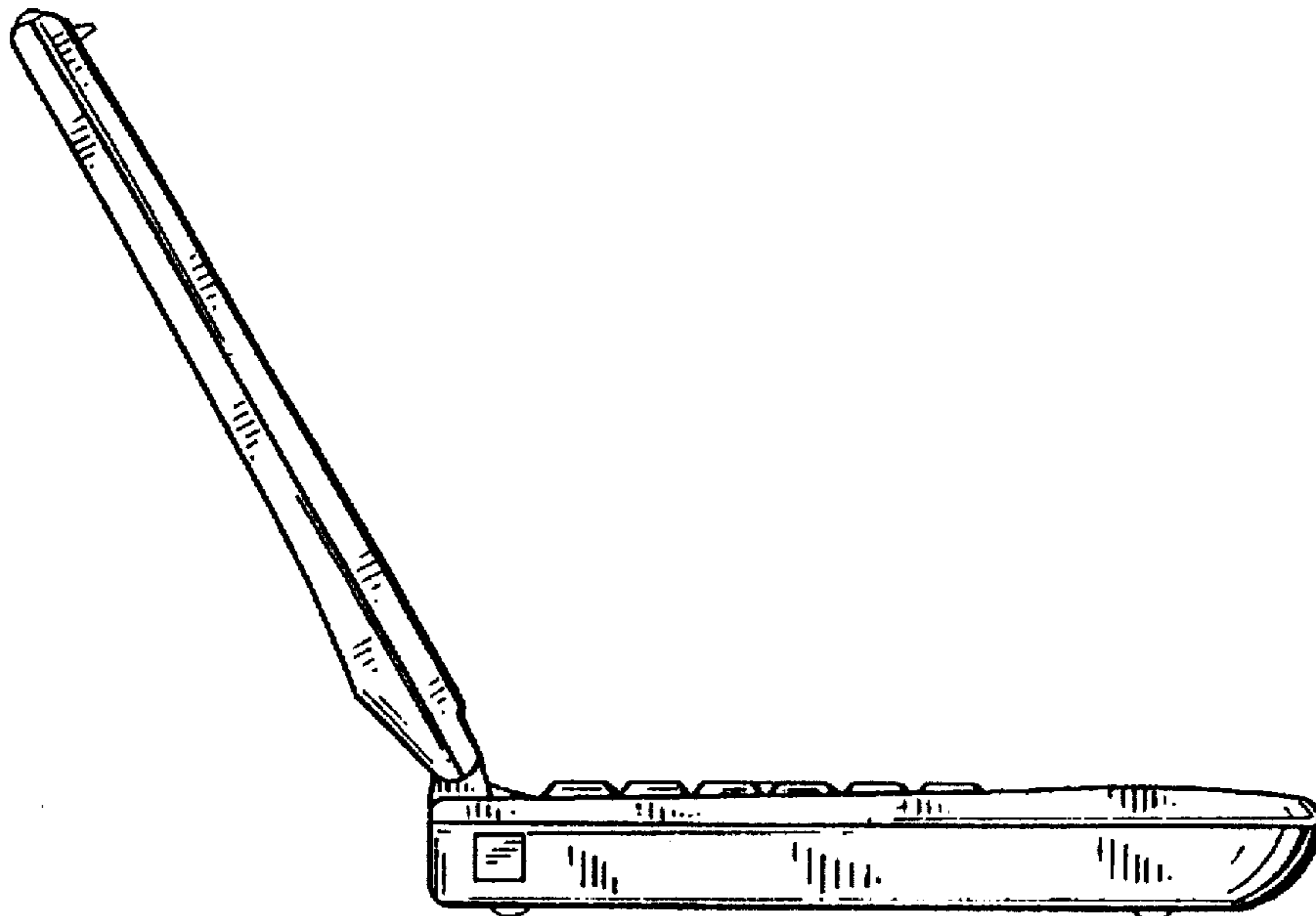

FIG. 7

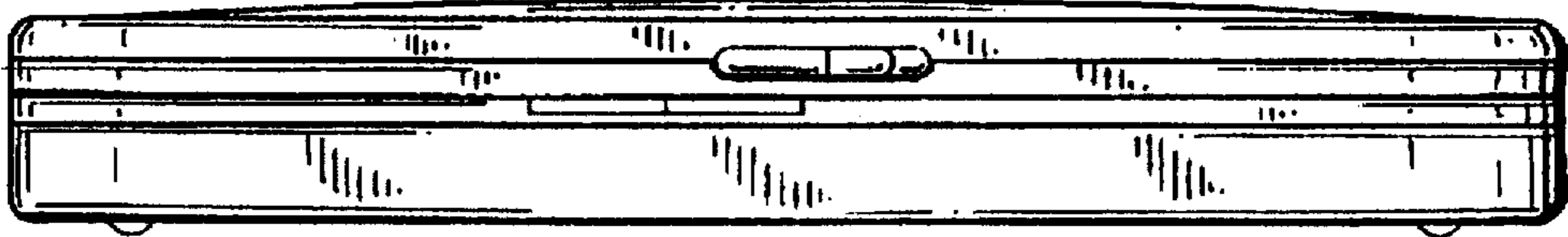

FIG. 8

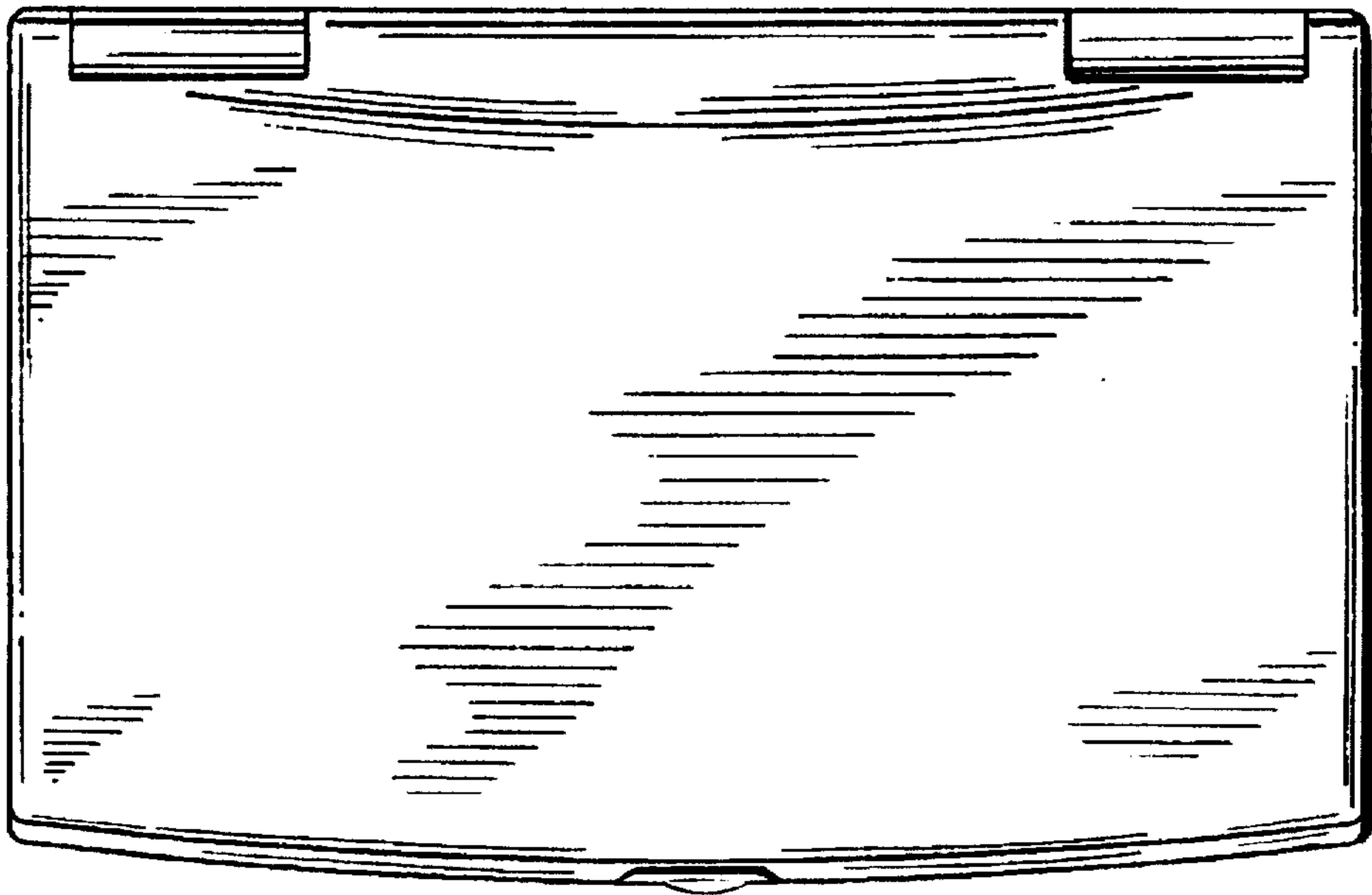

FIG. 9

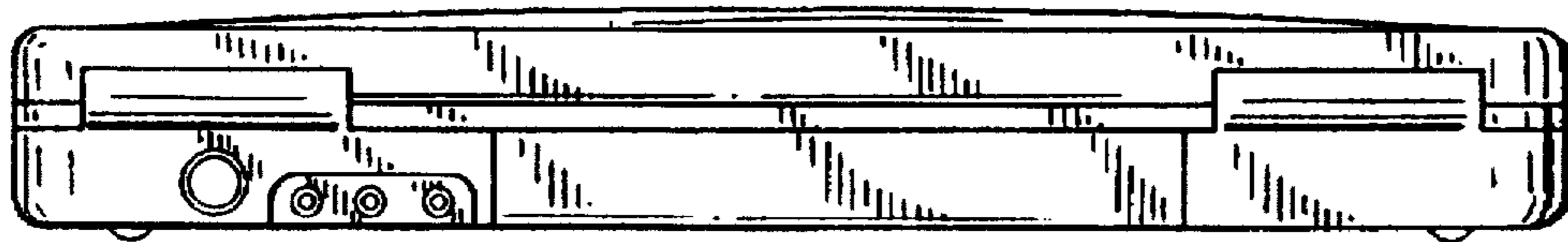

FIG. 10

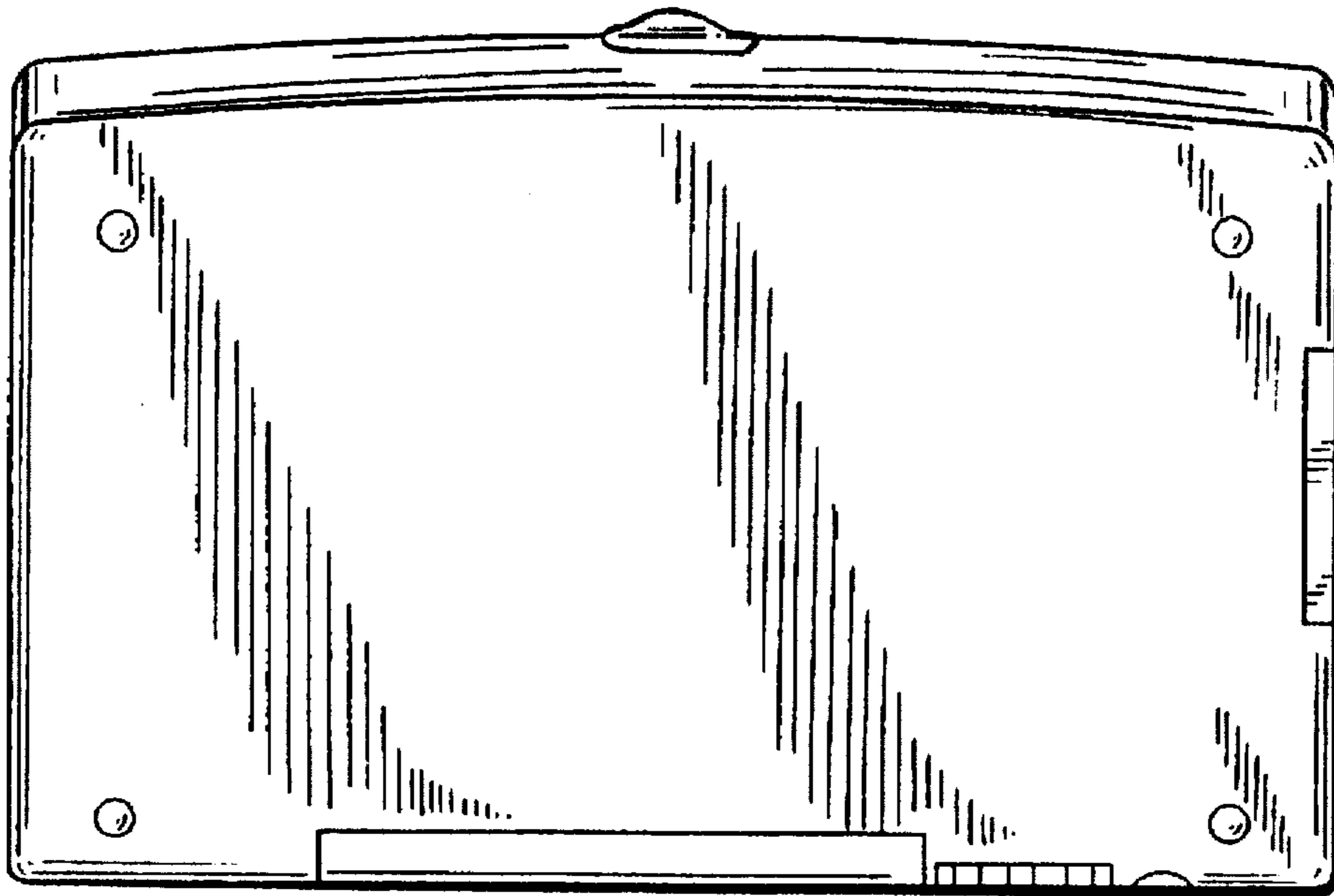

FIG. 11

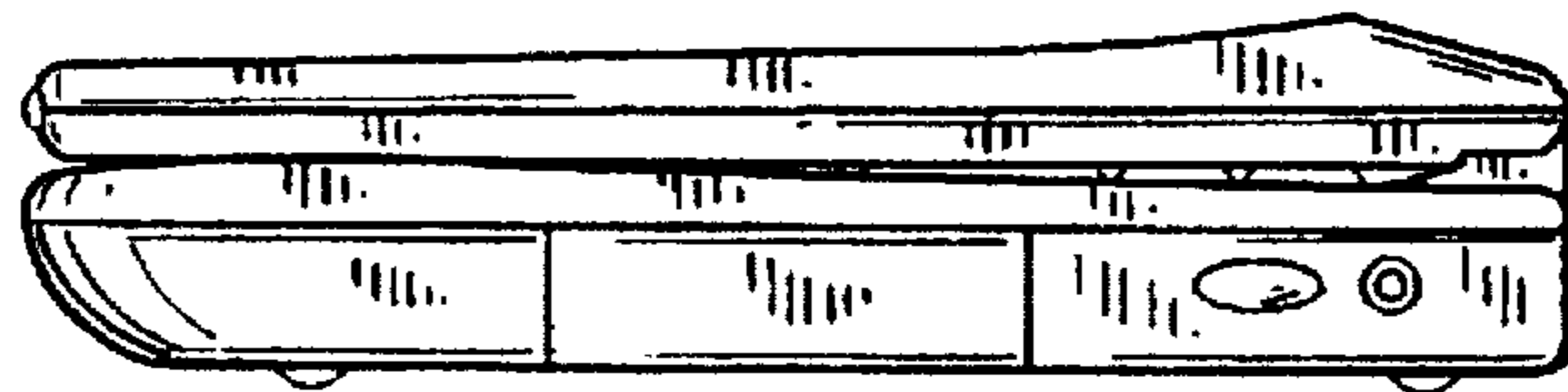

FIG. 12

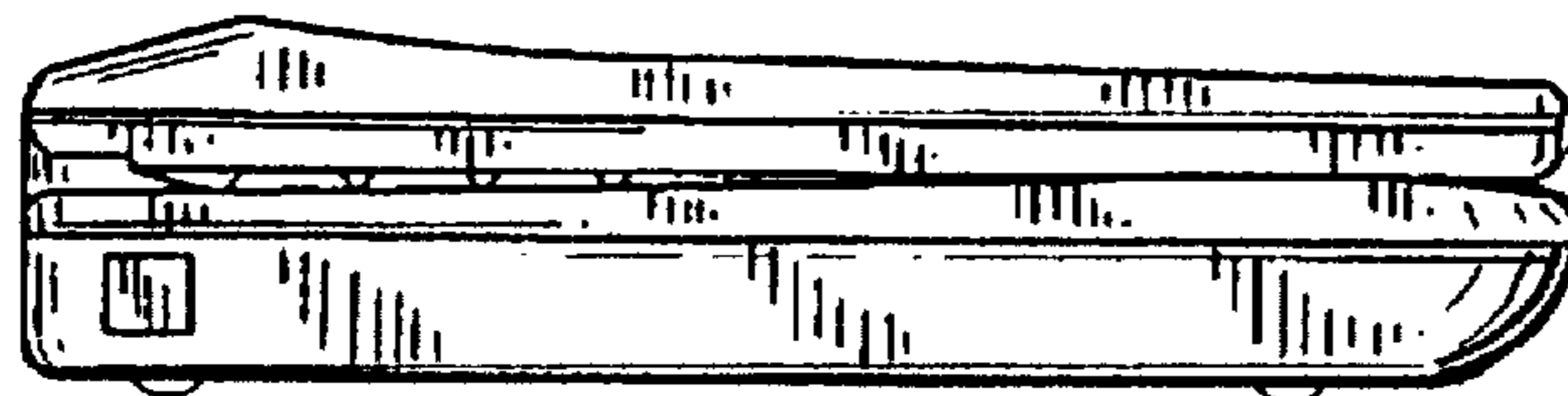

FIG. 13