



US00D385822S

United States Patent [19]

[11] Patent Number: Des. 385,822

Weder et al.

[45] Date of Patent: ***Nov. 4, 1997

[54] FLOWER POT COVER

[75] Inventors: Donald E. Weder; Joseph G. Straeter, both of Highland, Ill.

[73] Assignee: Southpac Trust International, Inc., Oklahoma City, Okla.; not individually, but as trustee of The Family Trust U/T/A dated December 8, 1995, Charles A. Codding, Authorized Signatory for Southpac Trust International, Inc. Trustee

[*] Notice: The portion of the term of this patent subsequent to Mar. 28, 2009, has been disclaimed.

[**] Term: 14 Years

[21] Appl. No.: 54,126

[22] Filed: May 7, 1996

Related U.S. Application Data

[60] Division of Ser. No. 4,472, Dec. 23, 1992, Pat. No. Des. 371,091, which is a continuation-in-part of Ser. No. 807,675, Dec. 16, 1991, Pat. No. Des. 356,755, which is a continuation-in-part of Ser. No. 710,272, Jun. 4, 1991, Pat. No. Des. 365,302, which is a continuation-in-part of Ser. No. 617,454, Nov. 21, 1990, abandoned, Ser. No. 411,249, Sep. 22, 1989, Pat. No. Des. 358,113, Ser. No. 411,247, Sep. 22, 1989, abandoned, and Ser. No. 411,245, Sep. 22, 1989, abandoned.

[51] LOC (6) Cl. 11-02

[52] U.S. Cl. D11/164

[58] Field of Search D11/143, 149, D11/152-156, 164, 89, 90; 47/66, 72; 206/423; 215/100.5; 229/1.5 R, 1.5 B, 4.5, 108, 108.1, 109, 110, 87.01, 922, 930, 186, 189; 428/27, 35.1, 24, 542.6; 338/122; D9/346, 428-431; D27/102, 133; D26/128-136; D19/96; D7/540, 584, 586, 587, 354

[56] References Cited

U.S. PATENT DOCUMENTS

D. 5,120 7/1871 Snow D11/154 X
D. 5,806 4/1872 Palmer D11/154

D. 50,435	3/1917	Stimpson	D11/143 X
D. 114,182	4/1939	Heisey	D11/154
D. 139,009	10/1944	Denenberg	D26/134
D. 174,733	5/1955	Bordman	D26/136
D. 292,182	10/1987	Weder et al.	D11/164
D. 292,562	11/1987	Weder et al.	D11/164
D. 293,224	12/1987	Weder et al.	D11/164
D. 293,775	1/1988	Weder et al.	D11/164
D. 317,583	6/1991	Weder et al.	D11/164
D. 318,030	7/1991	Weder et al.	D11/164
D. 327,234	6/1992	Vaughn	D11/143
2,334,805	11/1943	Barbieri	229/1.5 B
2,355,559	8/1944	Renner	229/8
5,127,817	7/1992	Weder et al.	425/383
5,184,390	2/1993	Weder	215/100.5 X

FOREIGN PATENT DOCUMENTS

103316 3/1938 Australia 229/922

OTHER PUBLICATIONS

Exhibit A—Speed Cover® Brochure—The Simple Solution . . . , ©1989.

Primary Examiner—Jeffrey Asch
Attorney, Agent, or Firm—Dunlap & Codding, P.C.

[57] CLAIM

The ornamental design for a flower pot cover, as shown and described.

DESCRIPTION

FIG. 1 is a perspective view of our new flower pot cover design;
FIG. 2 is a side elevational view thereof;
FIG. 3 is a top plan view thereof;
FIG. 4 is a bottom plan view thereof;
FIG. 5 is a side elevational view of the design of FIG. 1, the only difference being in the horizontal angle of the skirt;
FIG. 6 is a side elevational view of the design of FIG. 1, the only difference being in the near vertical angle of the skirt;
FIG. 7 is a side elevational view of the design of FIG. 1, the only difference being in the downward angle of the skirt;
FIG. 8 is a perspective view of a second embodiment of our new flower pot cover design;
FIG. 9 is a side elevational view thereof;
FIG. 10 is a top plan view thereof;
FIG. 11 is a bottom plan view thereof;

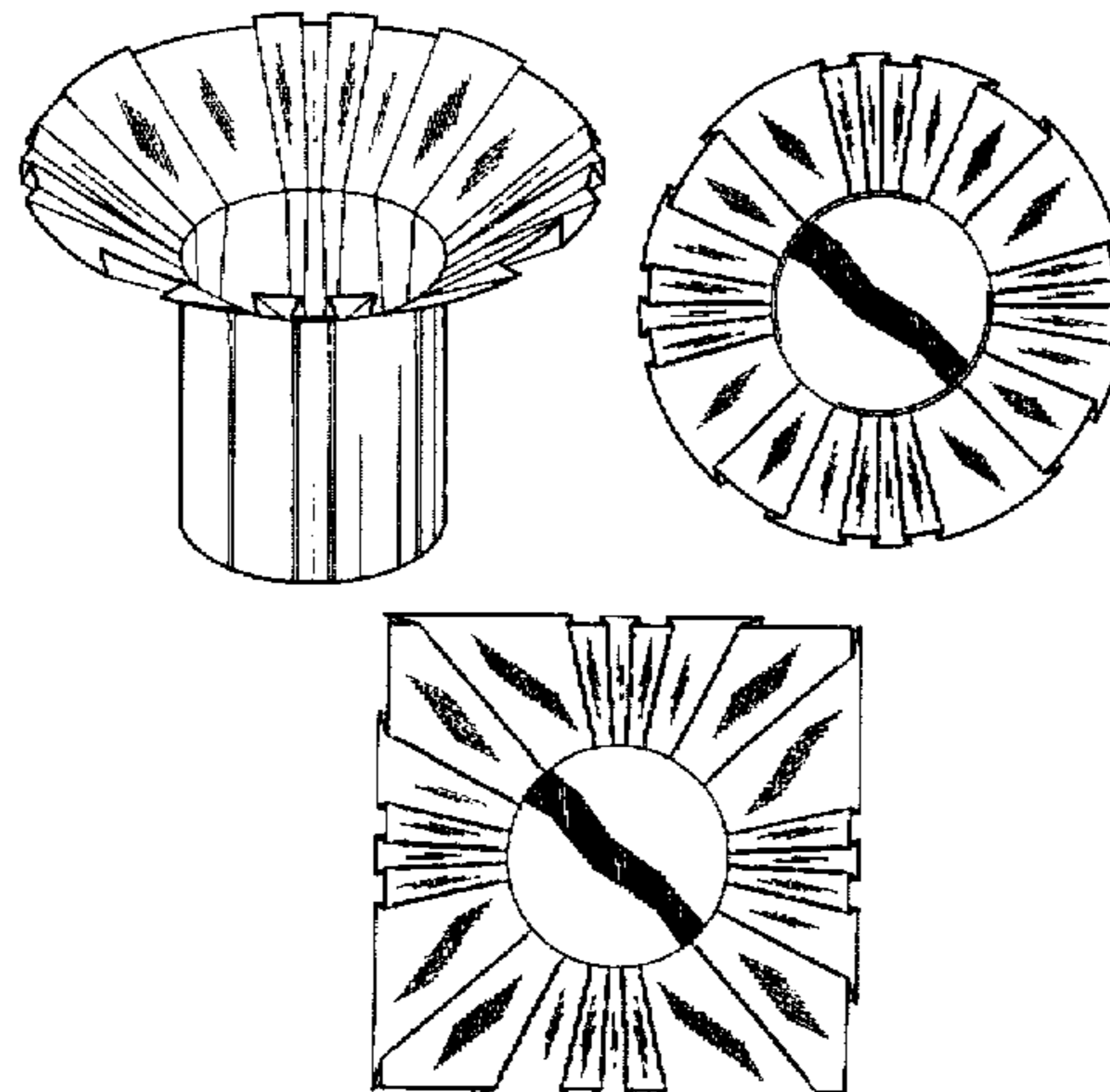

FIG. 12 is a side elevational view of the design of FIG. 8, the only difference being in the horizontal angle of the skirt; FIG. 13 is a side elevational view of the design of FIG. 8, the only difference being in the near vertical angle of the skirt;

FIG. 14 is a side elevational view of the design of FIG. 8, the only difference being in the downward angle of the skirt; FIG. 15 is a perspective view of a third embodiment of our new flower pot cover design;

FIG. 16 is a side elevational view thereof;

FIG. 17 is a top plan view thereof;

FIG. 18 is a bottom plan view thereof;

FIG. 19 is a side elevational view of the design of FIG. 15, the only difference being in the horizontal angle of the skirt;

FIG. 20 is a side elevational view of the design of FIG. 15, the only difference being in the near vertical angle of the skirt;

FIG. 21 is a side elevational view of the design of FIG. 15, the only difference being in the downward angle of the skirt; FIG. 22 is a perspective view of a fourth embodiment of our new flower pot cover design;

FIG. 23 is a side elevational view thereof;

FIG. 24 is a top plan view thereof;

FIG. 25 is a bottom plan view thereof;

FIG. 26 is a side elevational view of the design of FIG. 22, the only difference being in the horizontal angle of the skirt;

FIG. 27 is a side elevational view of the design of FIG. 22, the only difference being in the near vertical angle of the skirt; and,

FIG. 28 is a side elevational view of the design of FIG. 22, the only difference being in the downward angle of the skirt. The flower pot cover has no substantial thickness.

1 Claim, 7 Drawing Sheets

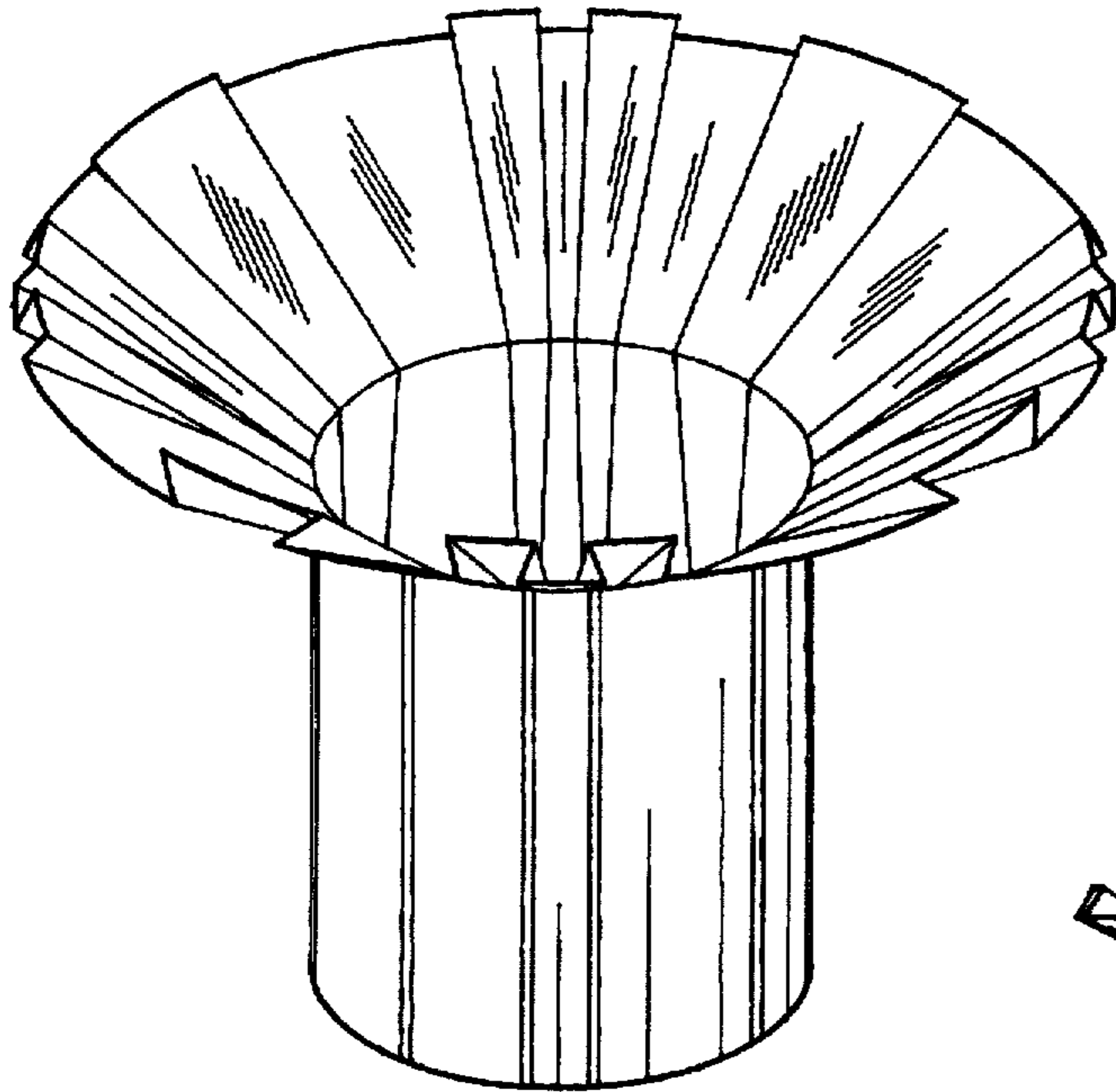

FIG. 1

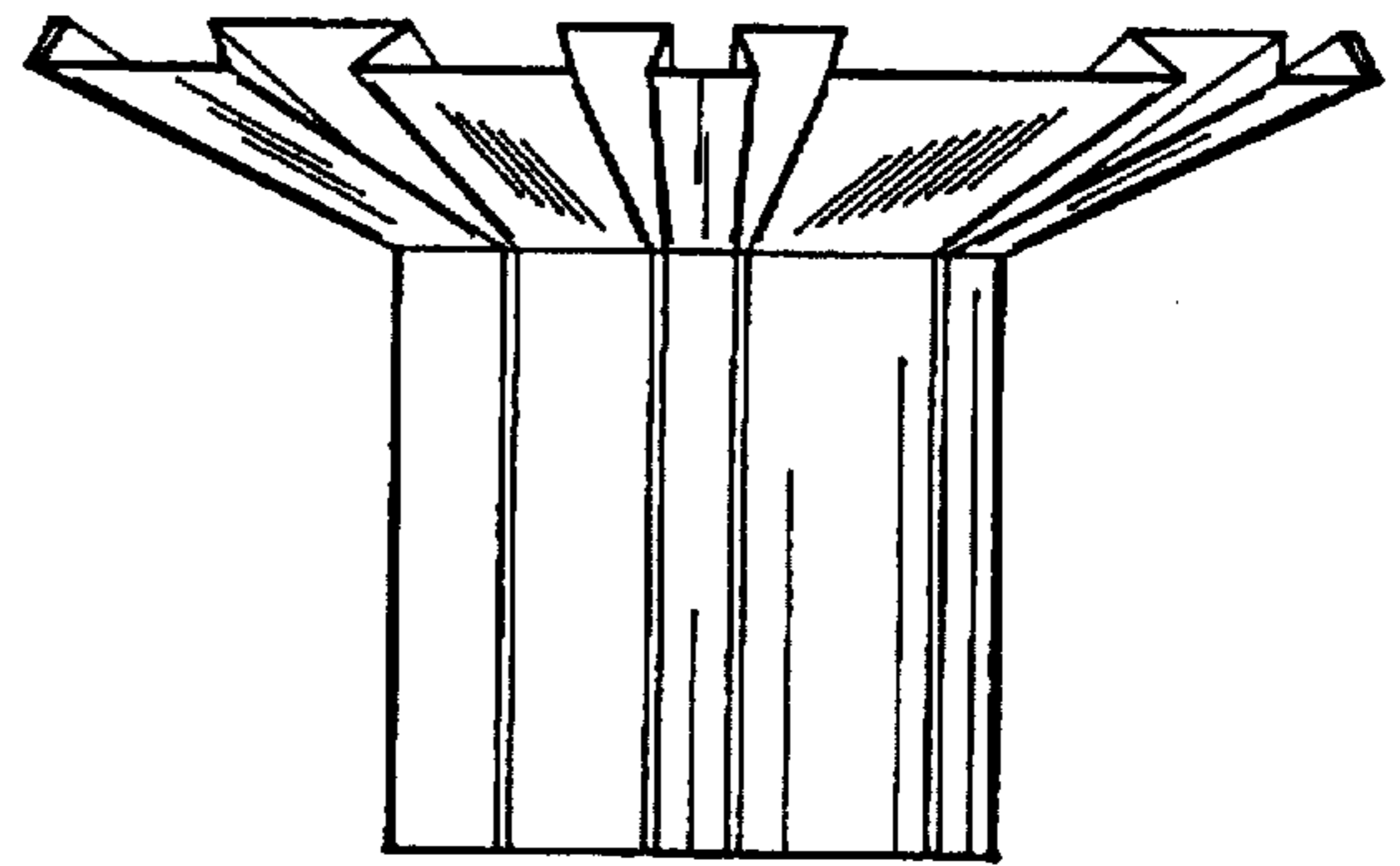

FIG. 2

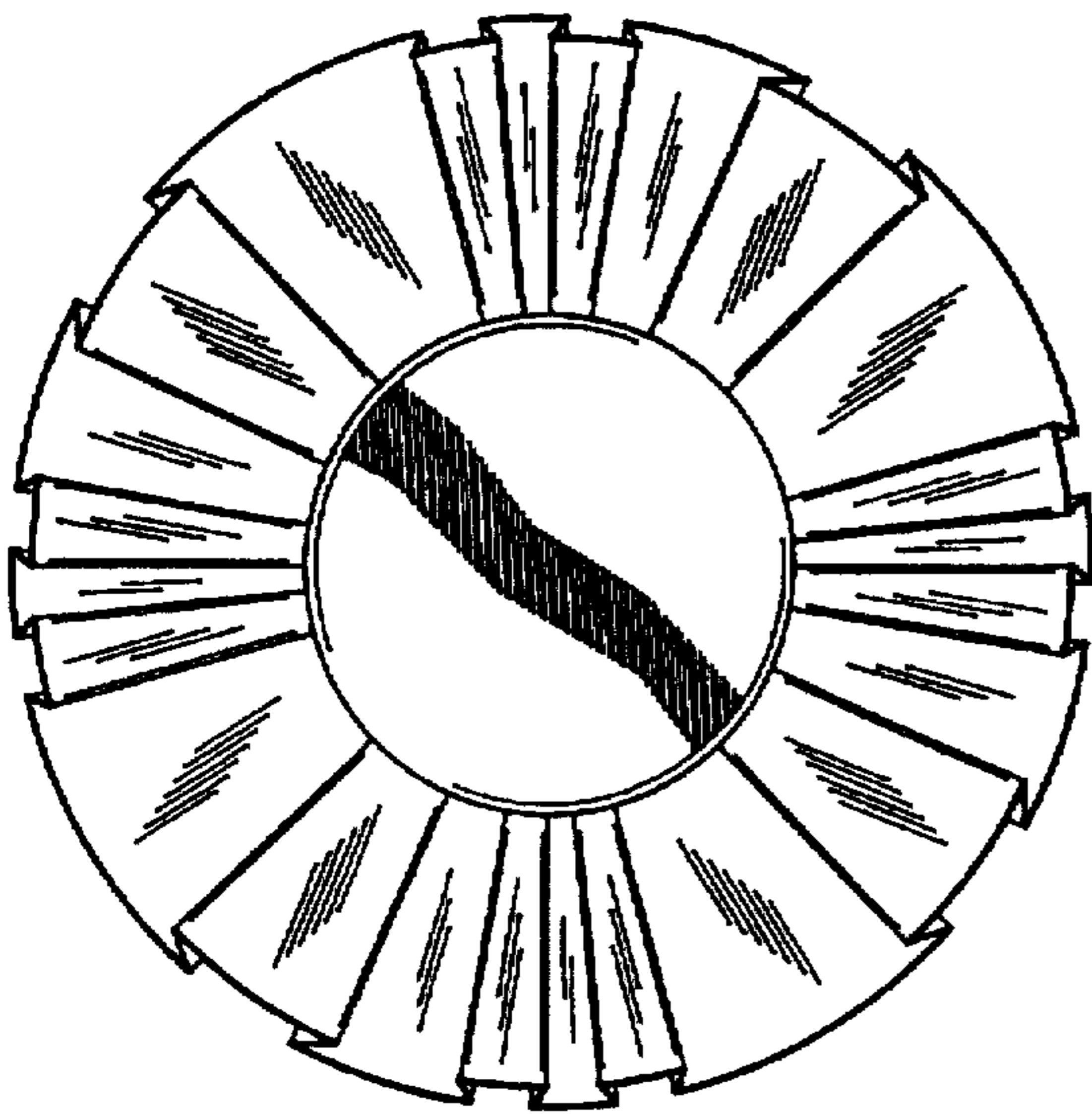

FIG. 3

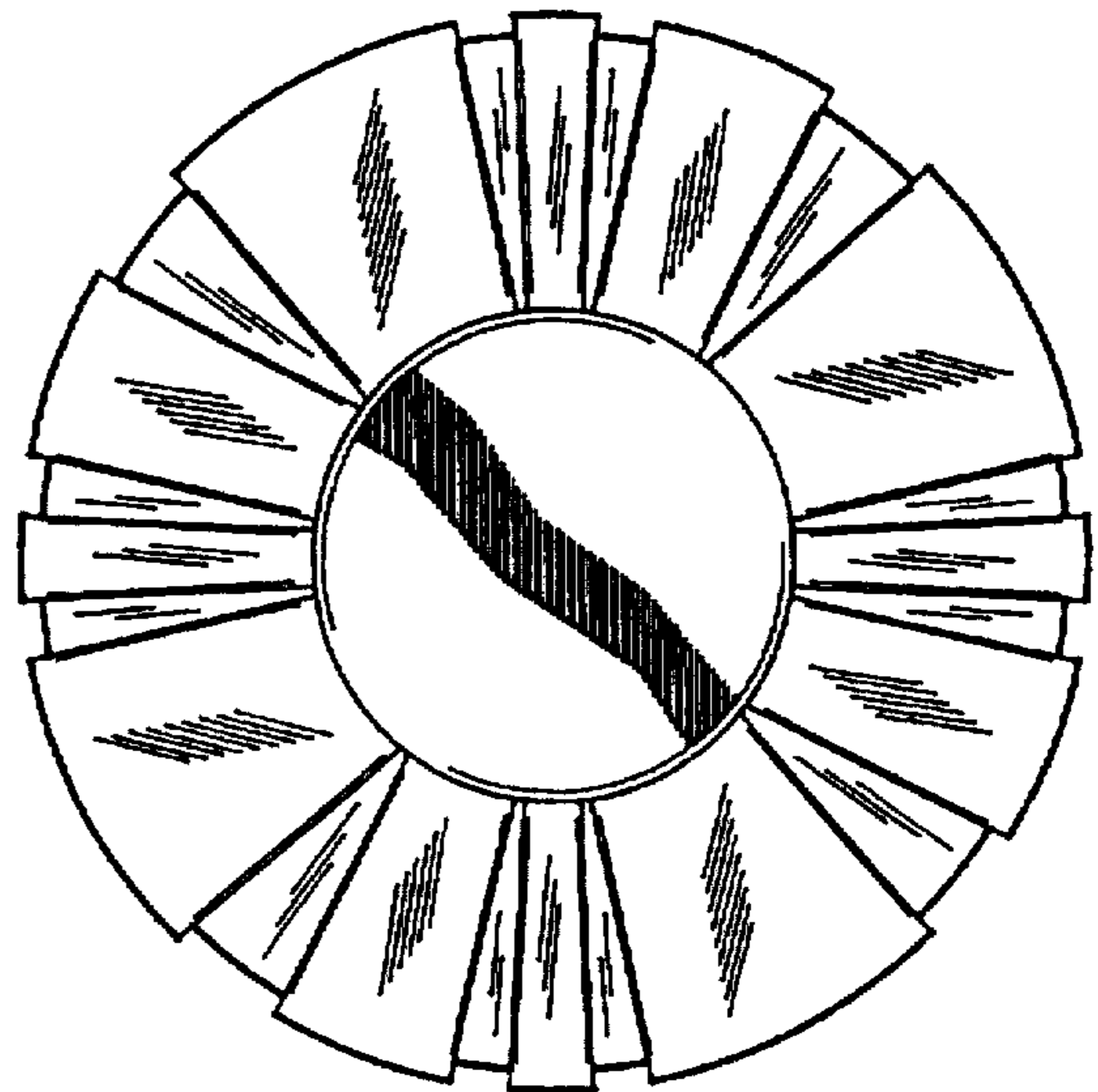

FIG. 4

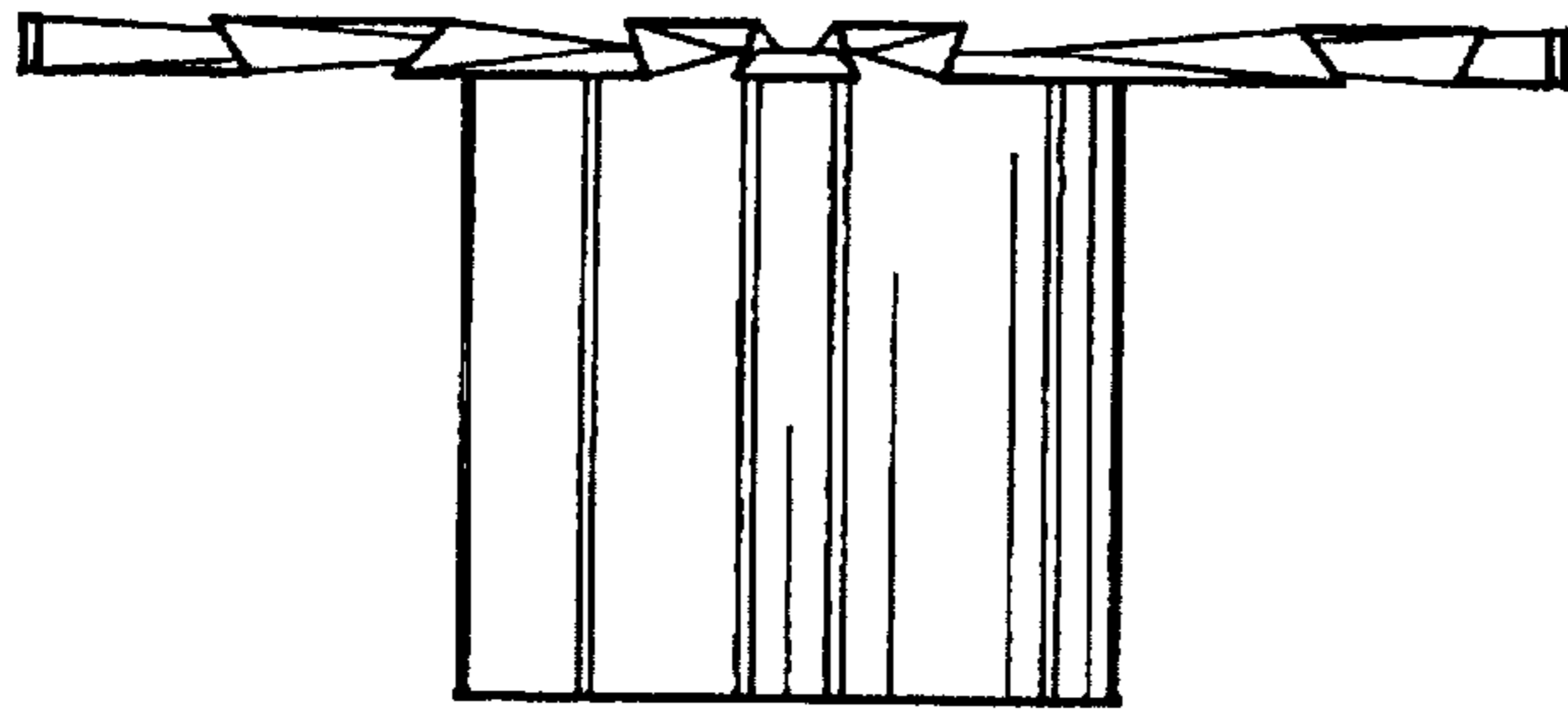

FIG. 5

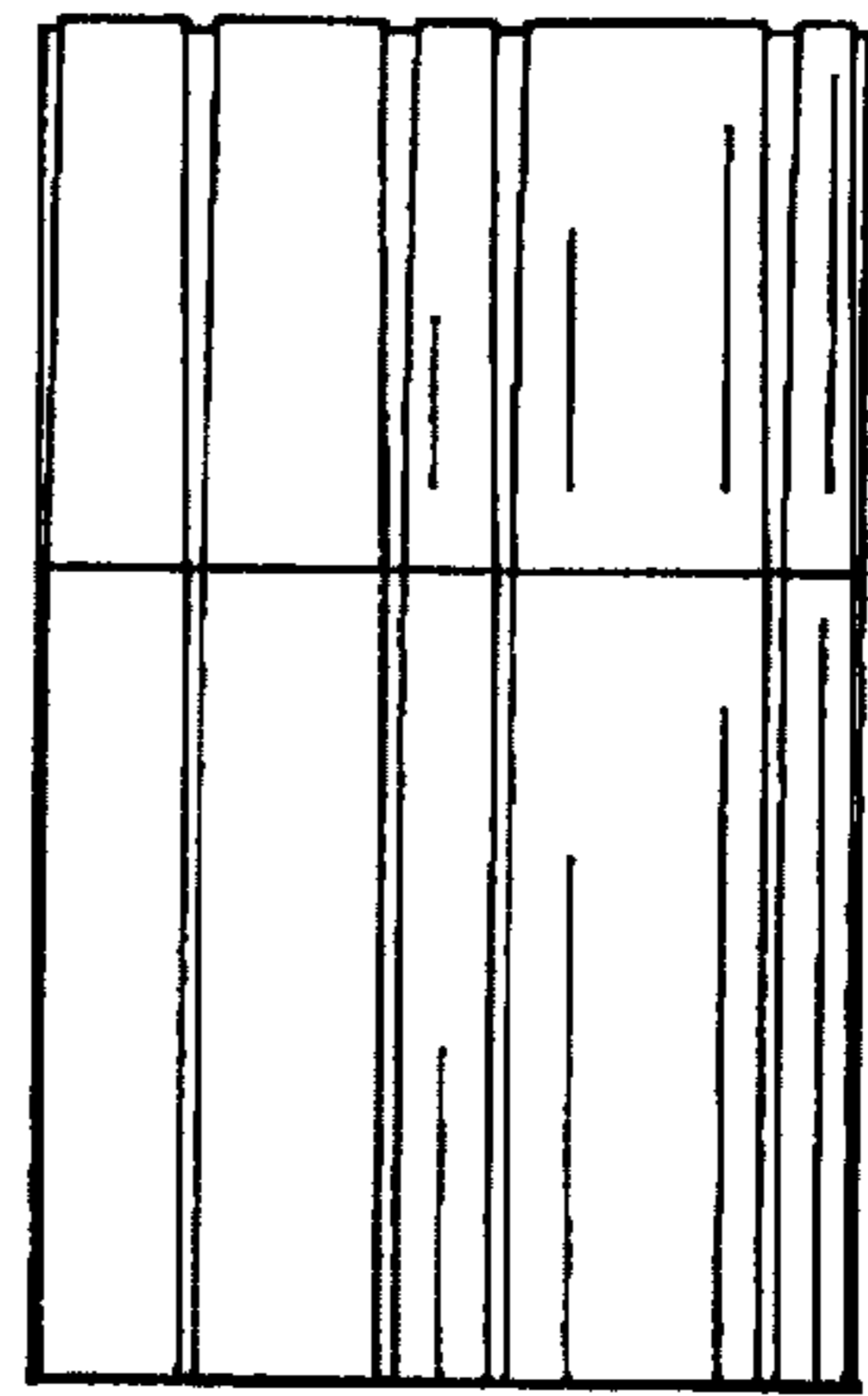

FIG. 6

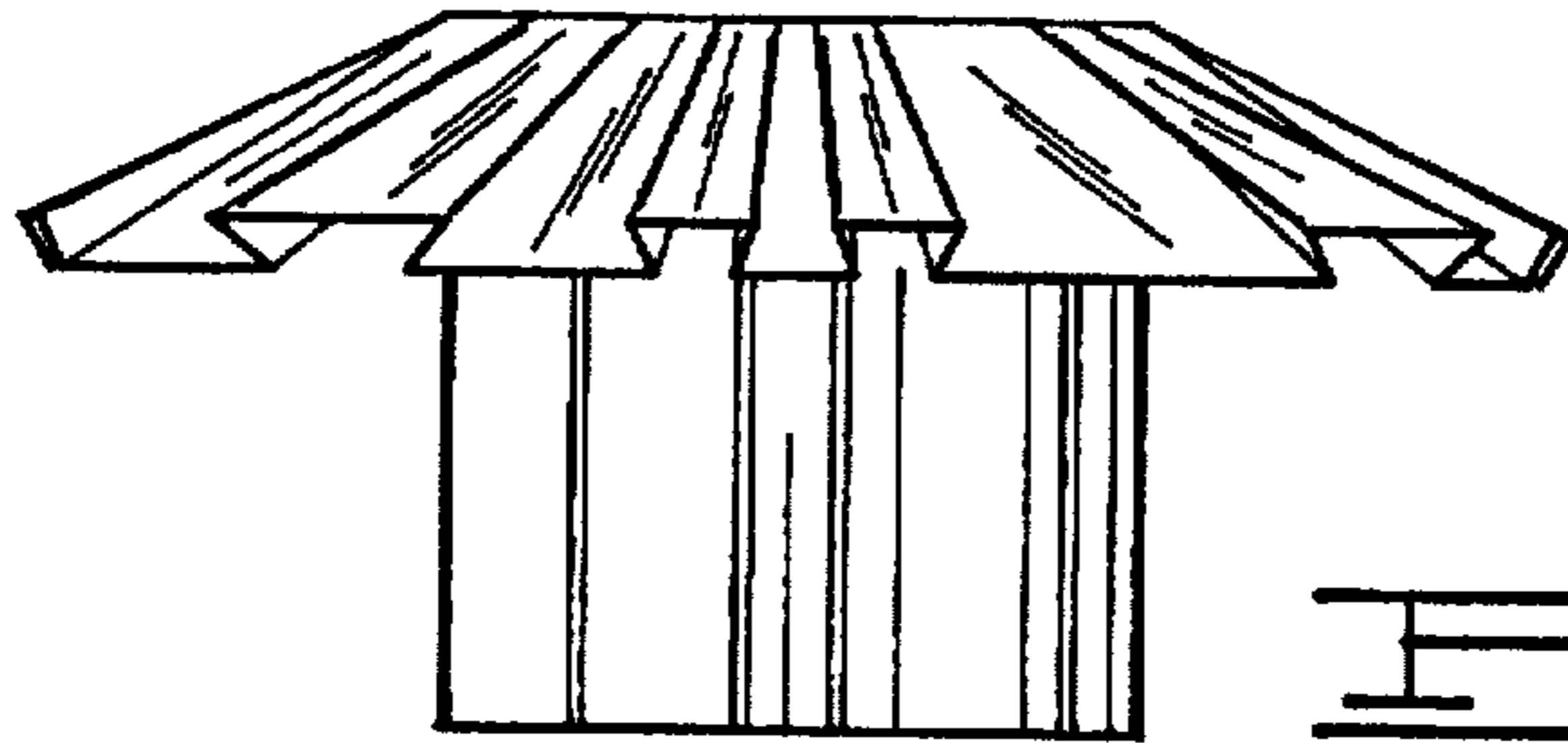

FIG. 7

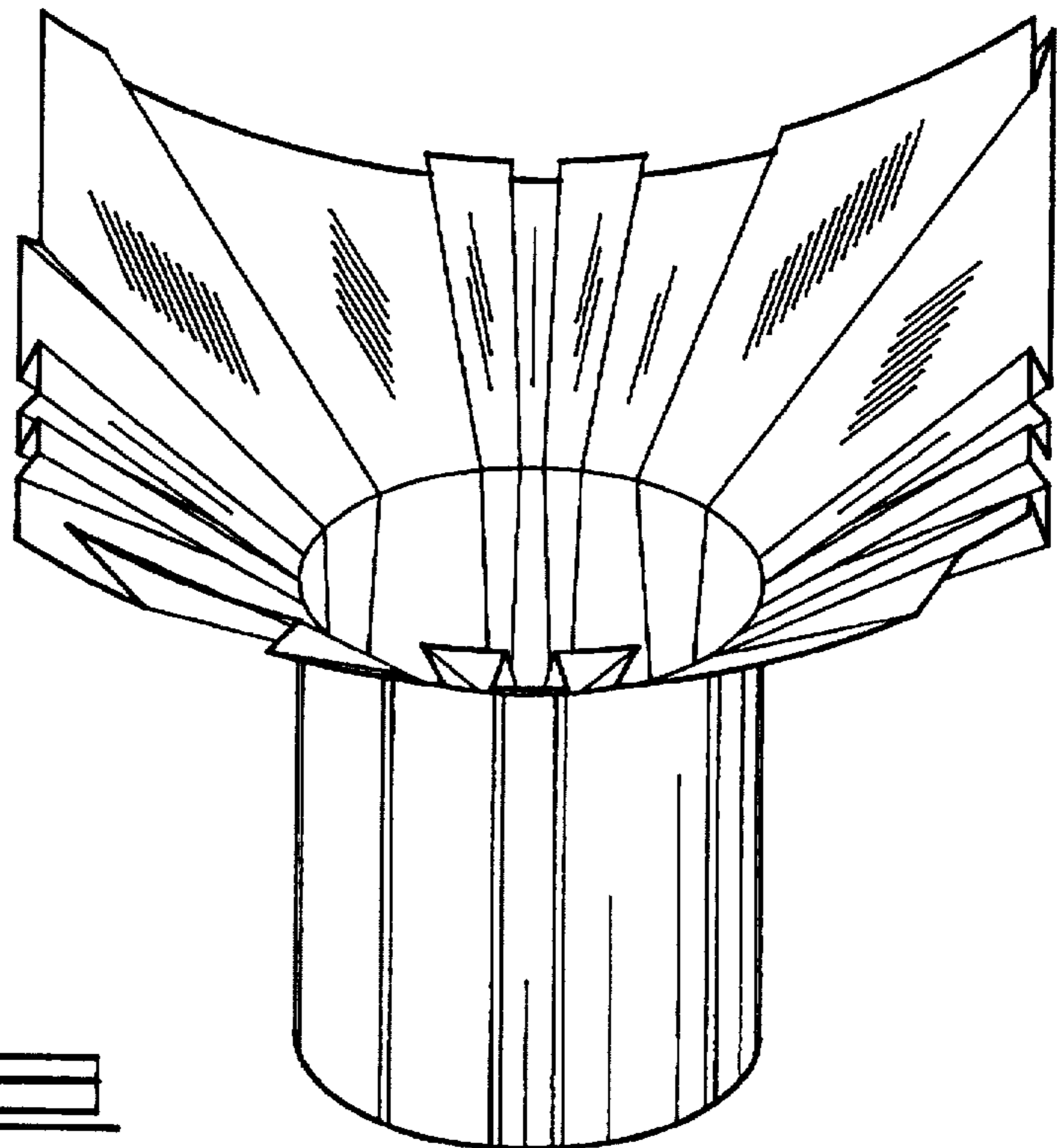

FIG. 8

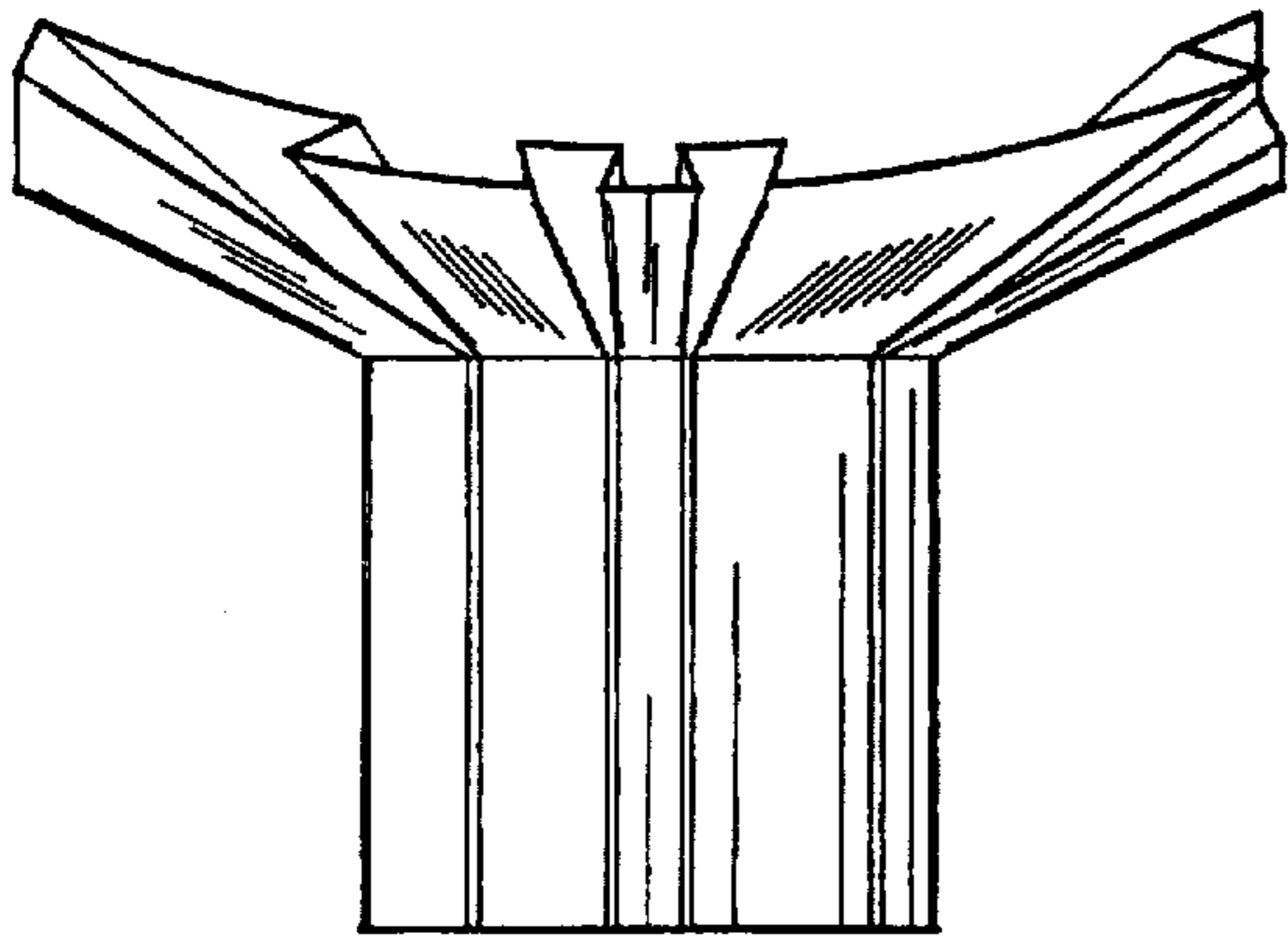

FIG. 9

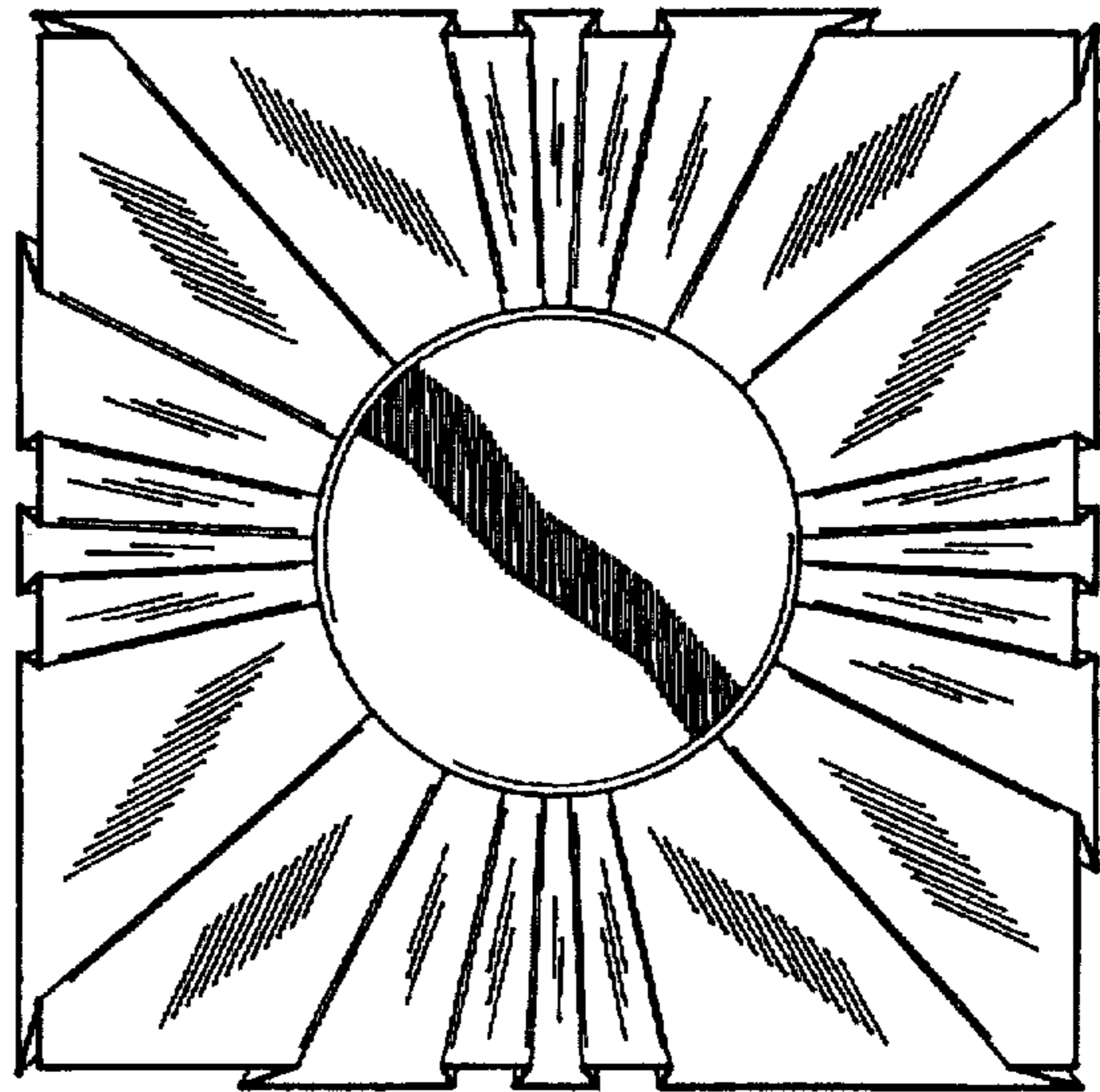

FIG. 10

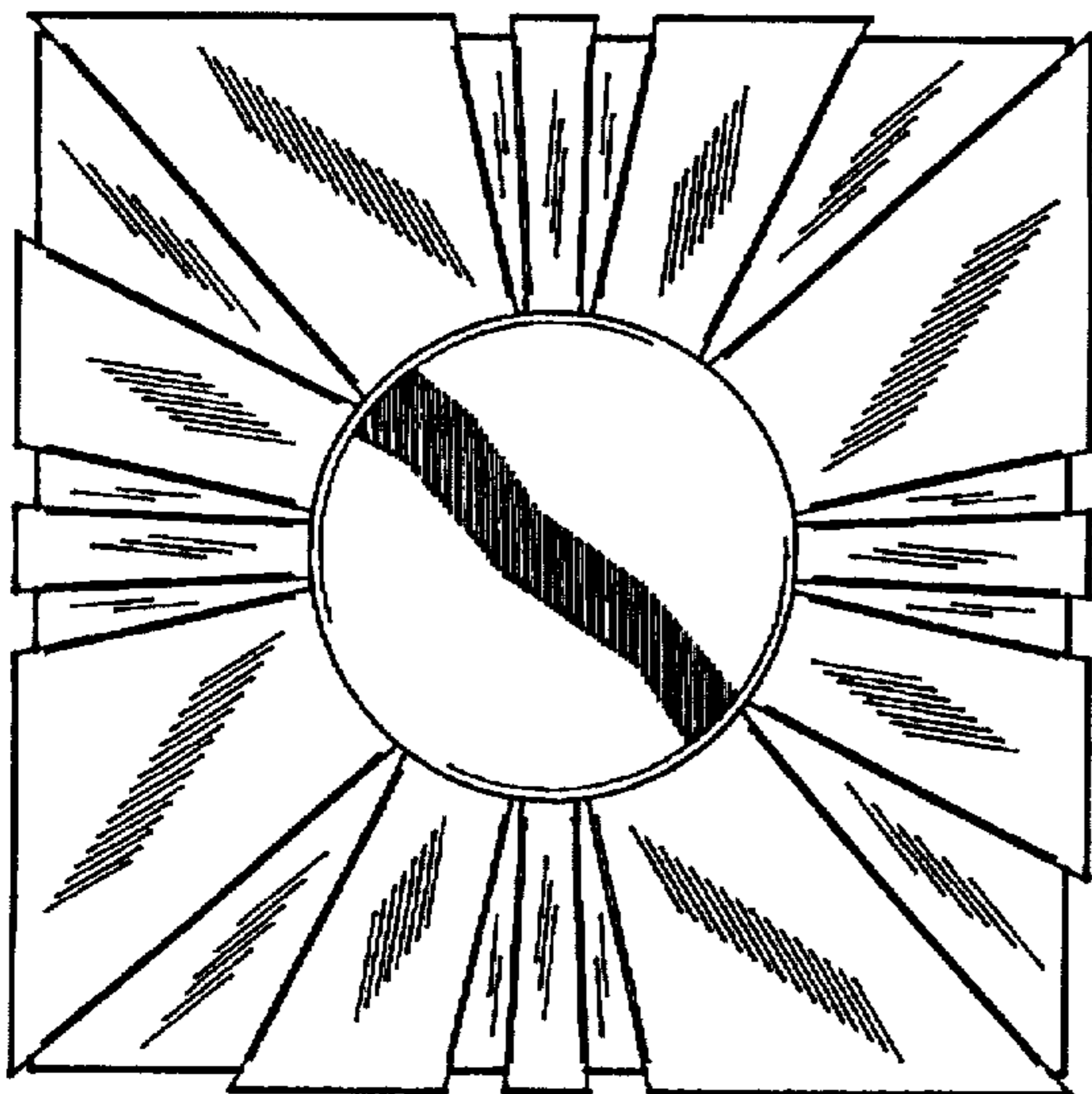

FIG. 11

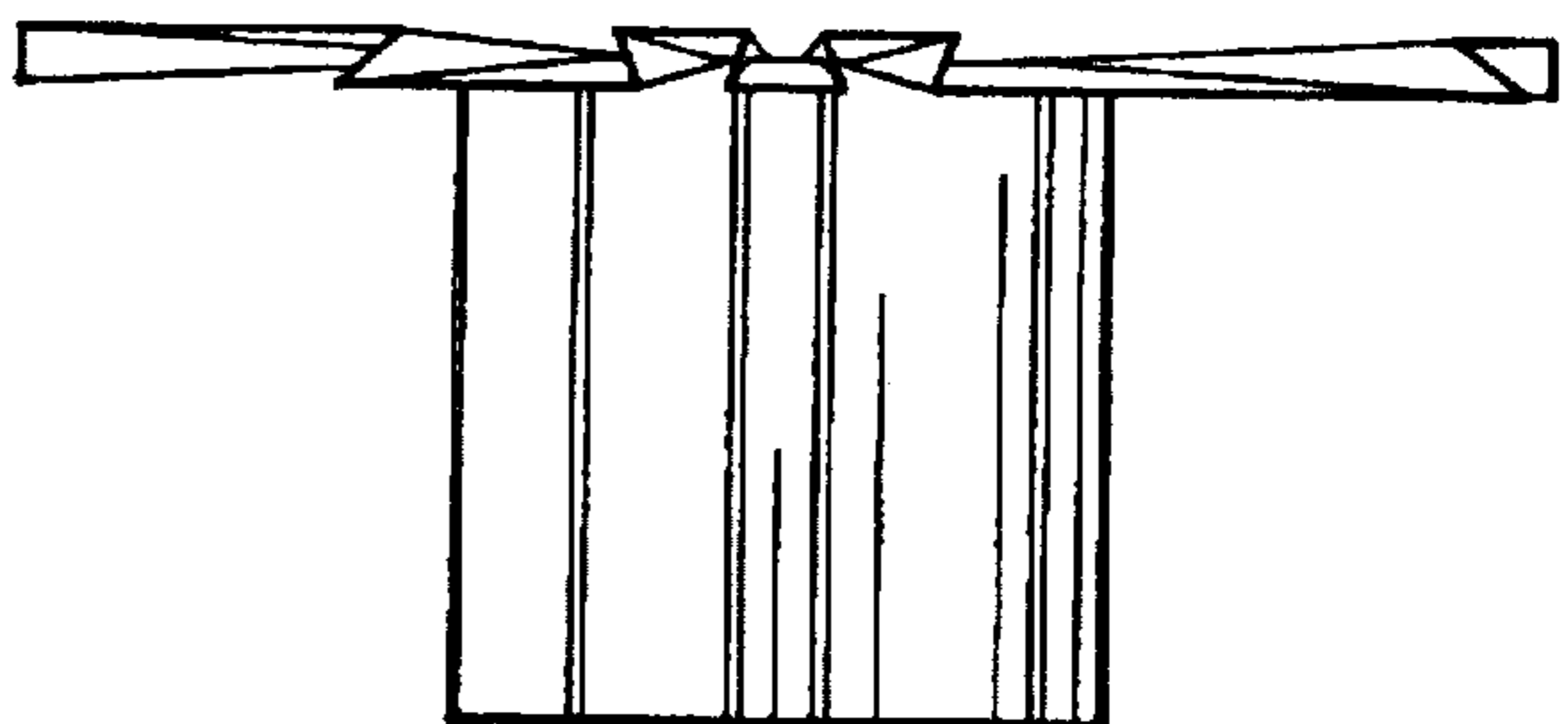

FIG. 12

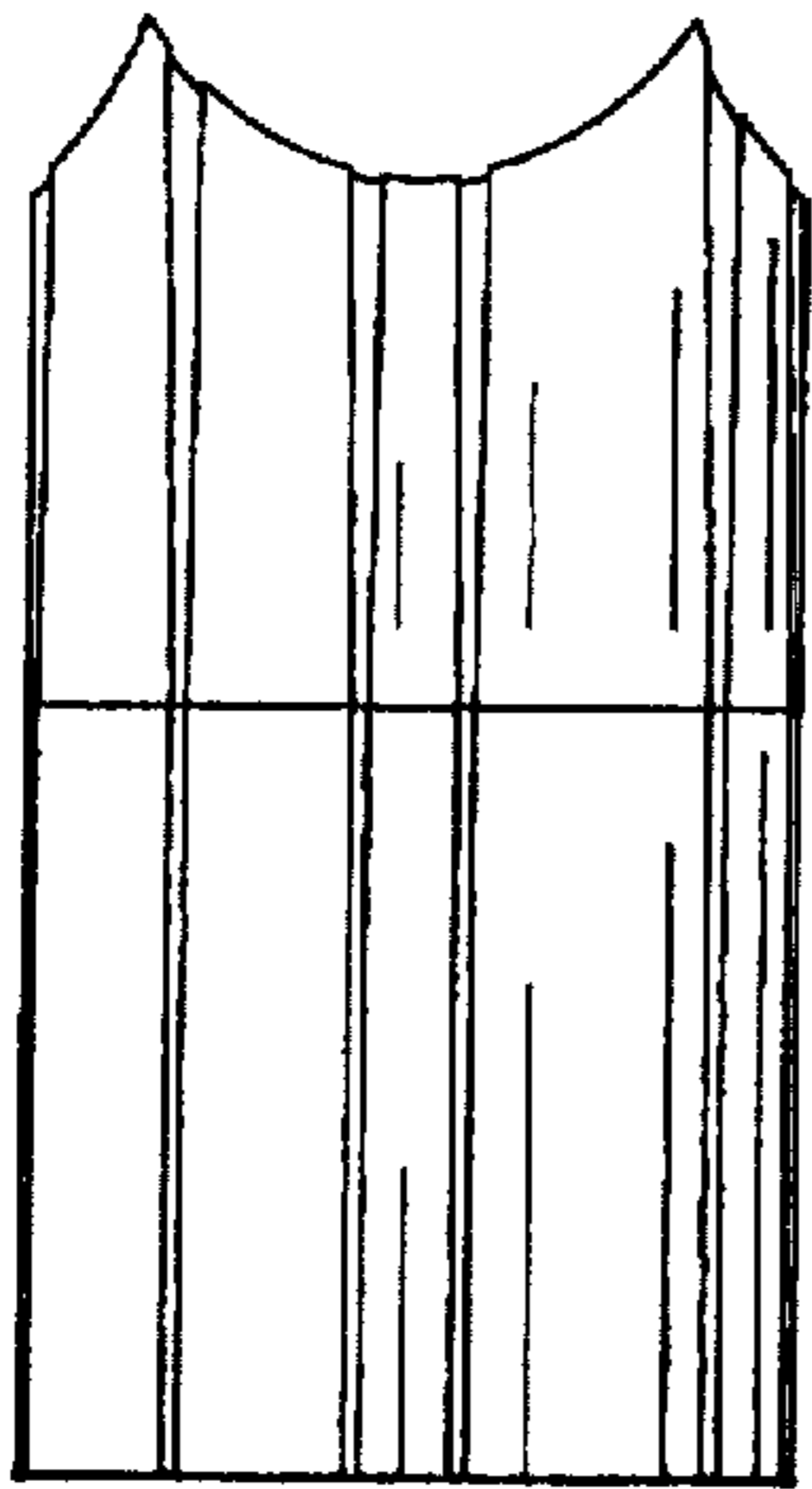

FIG. 13

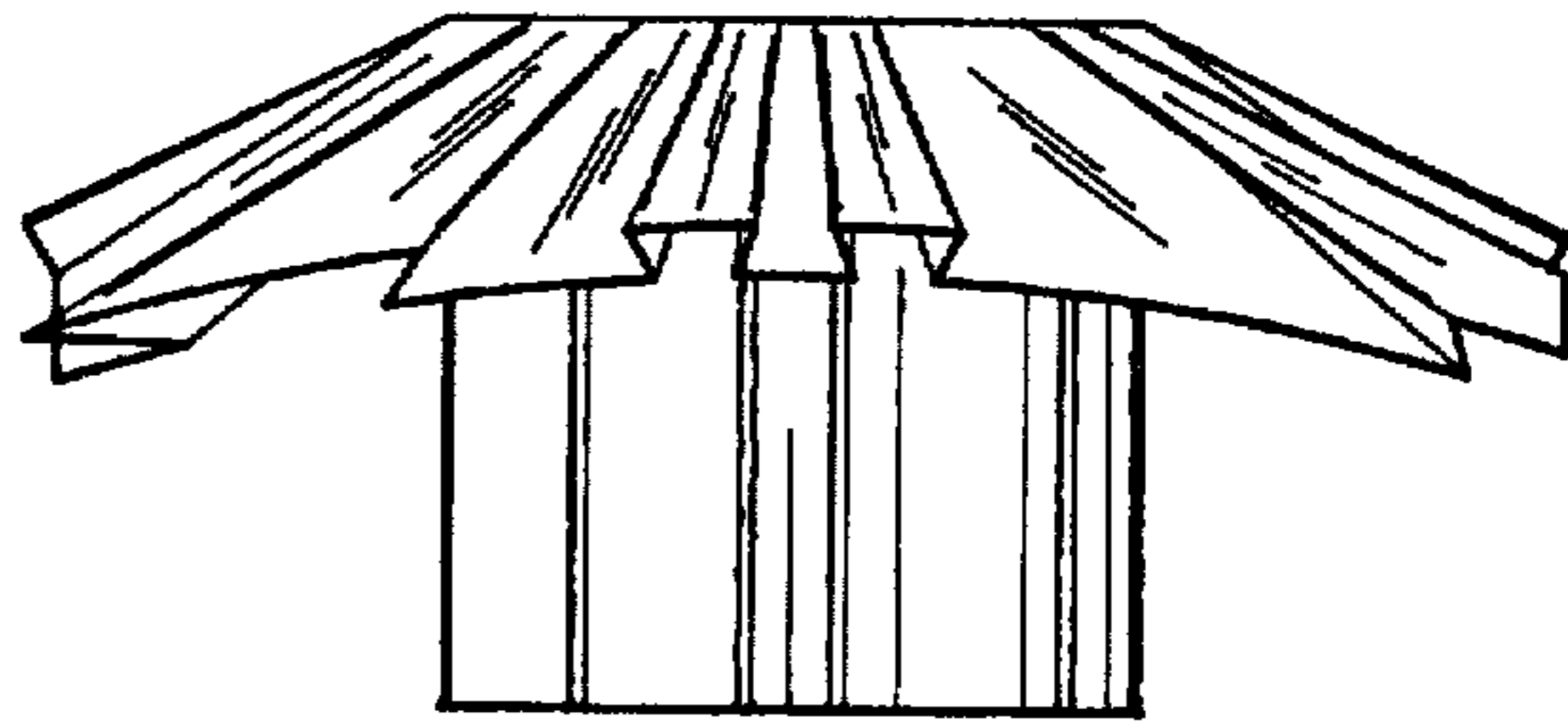

FIG. 14

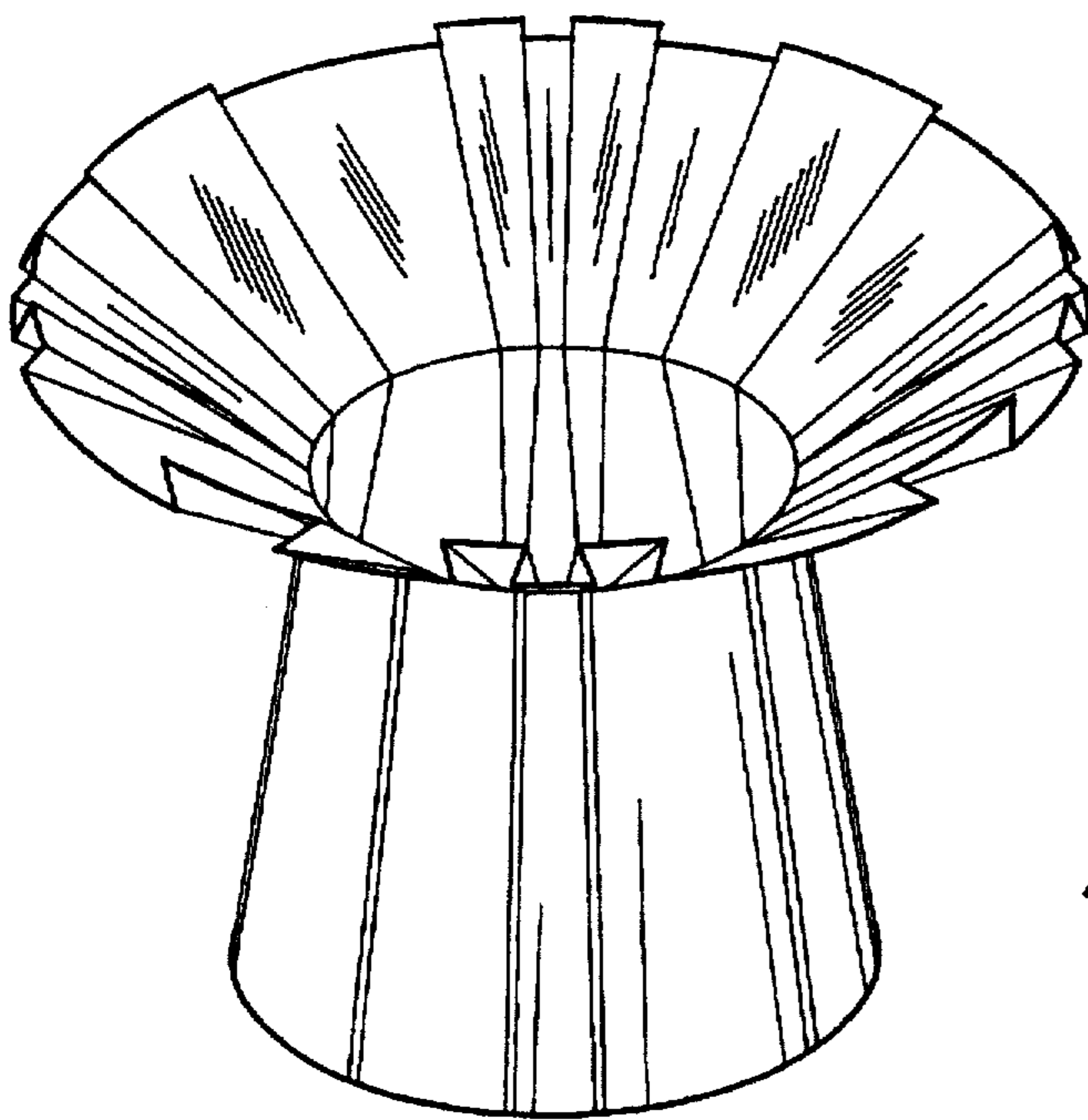

FIG. 15

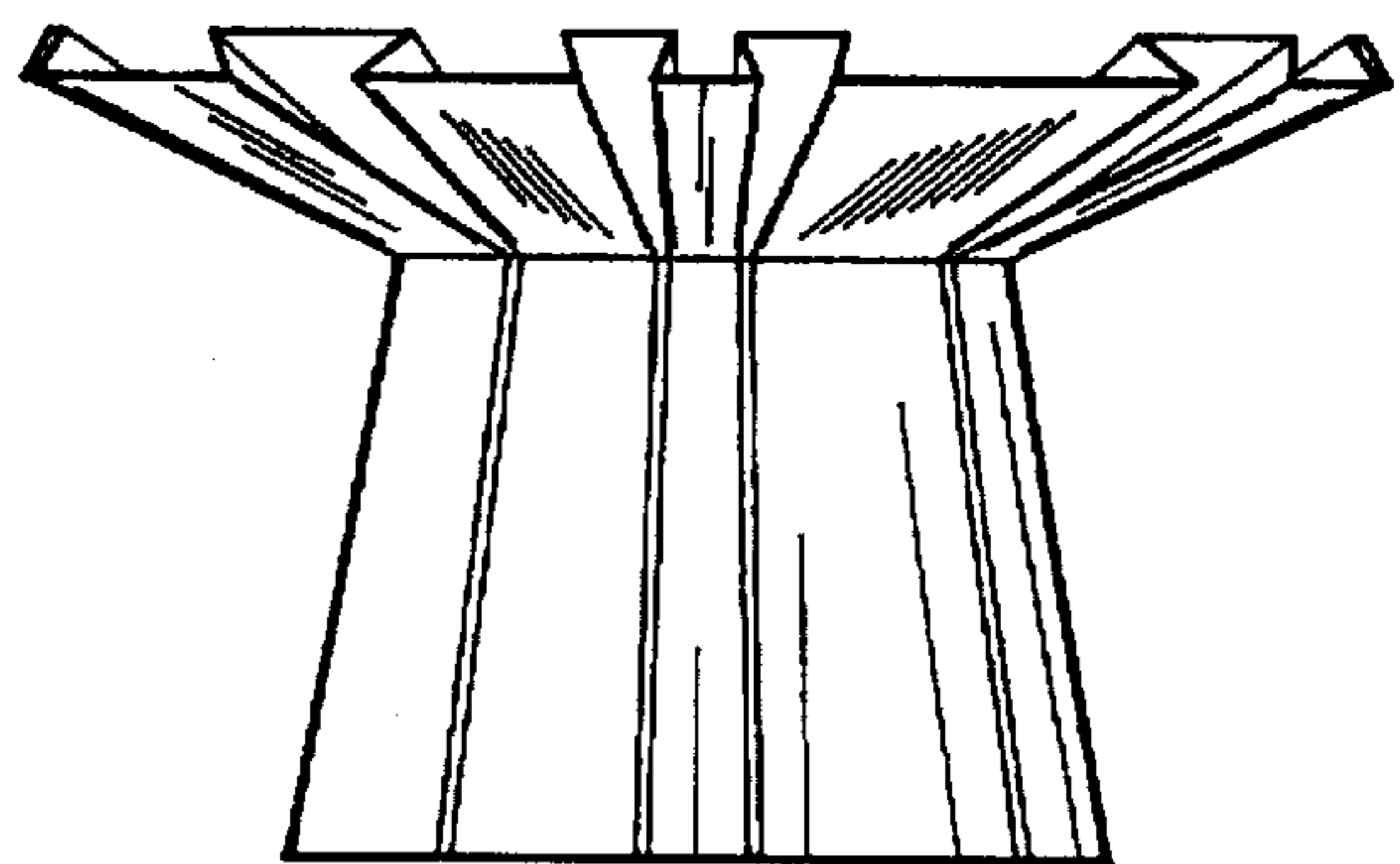

FIG. 16

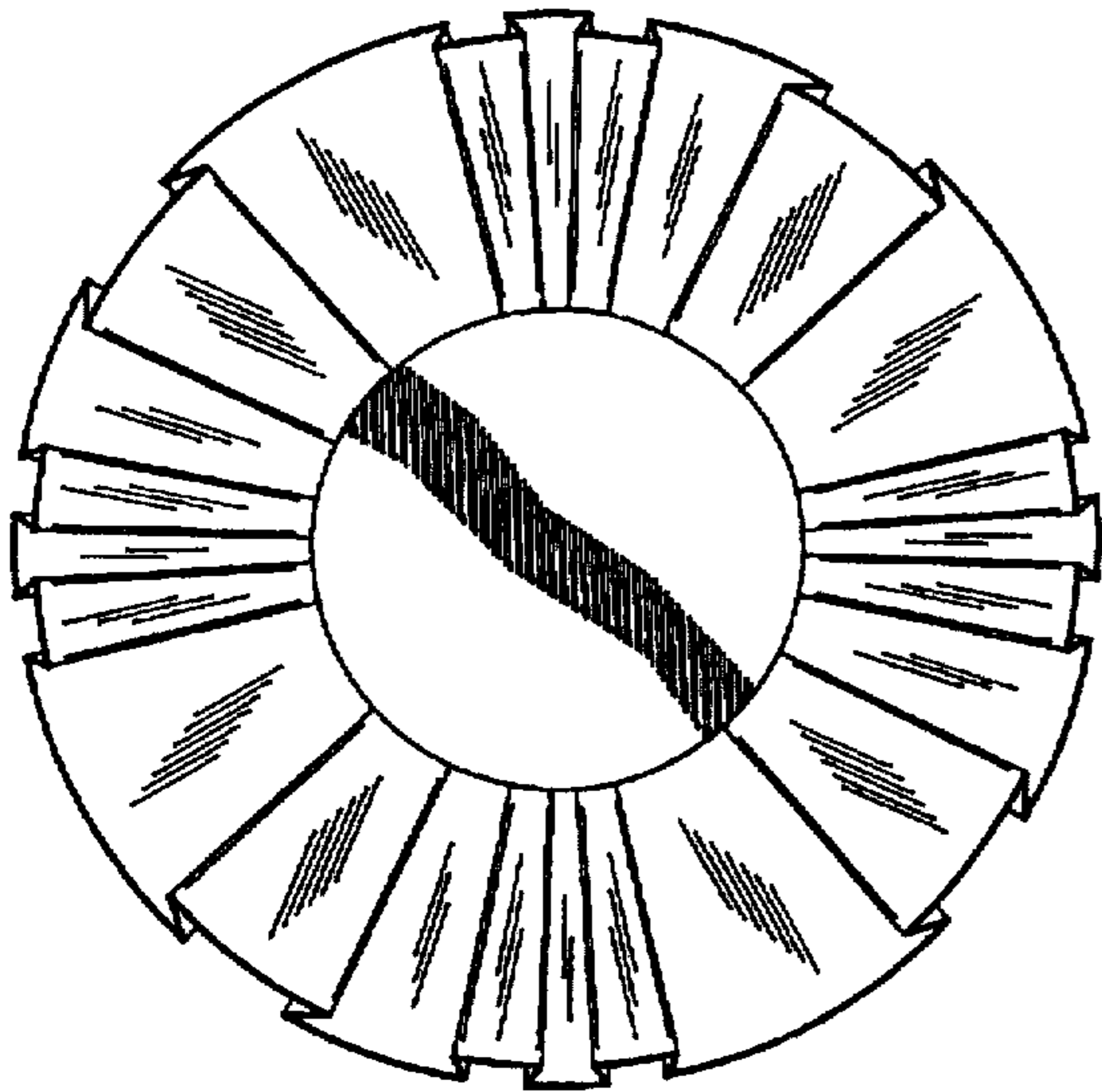

FIG. 17

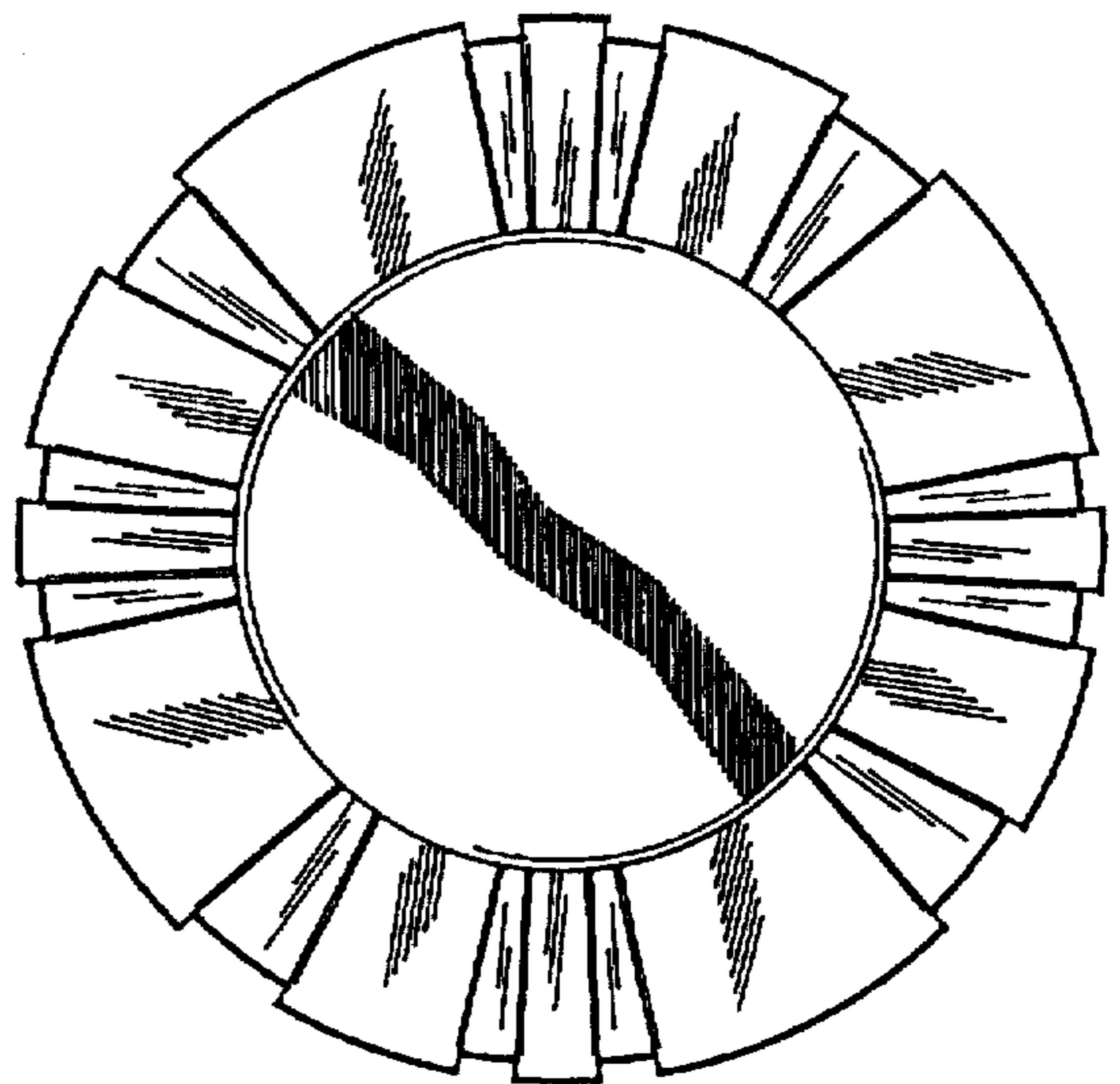

FIG. 18

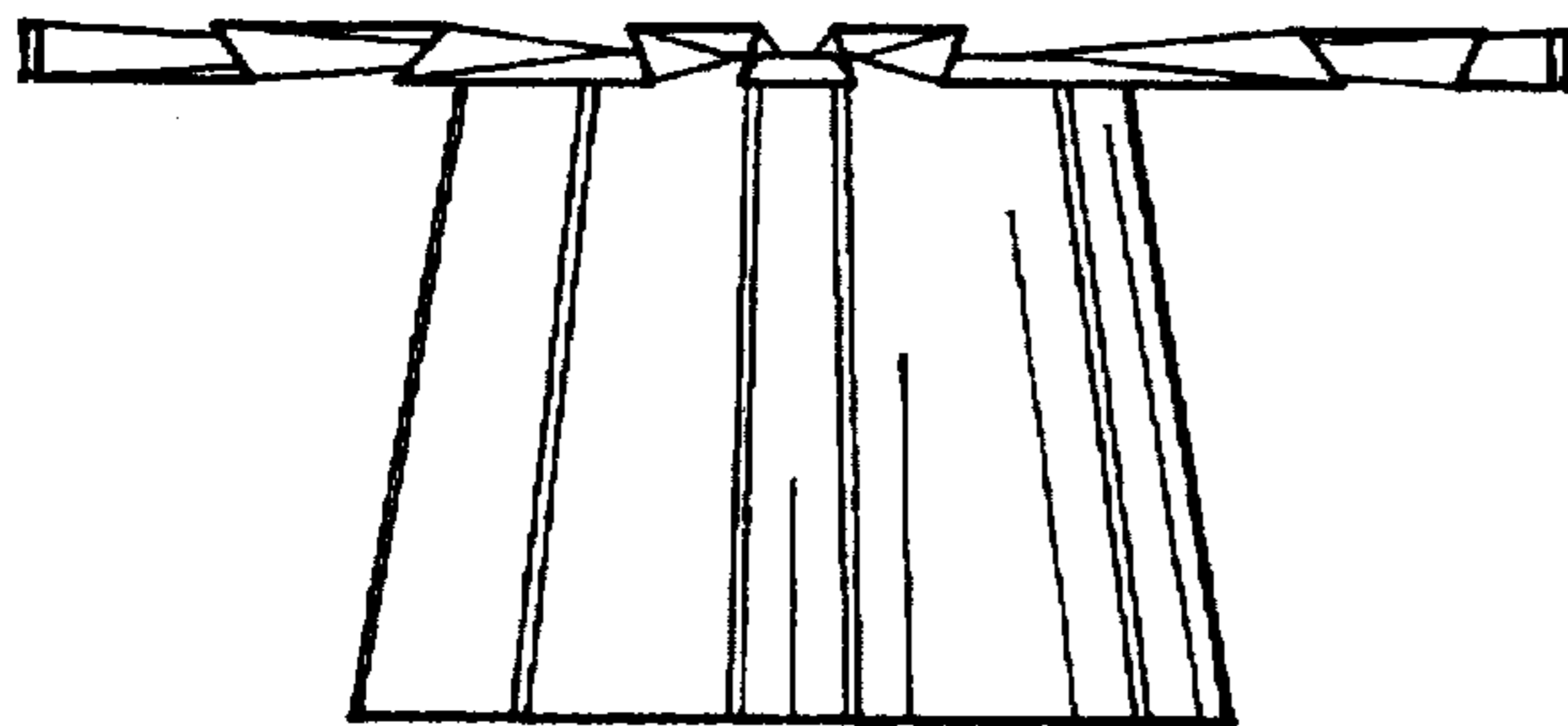

FIG. 19

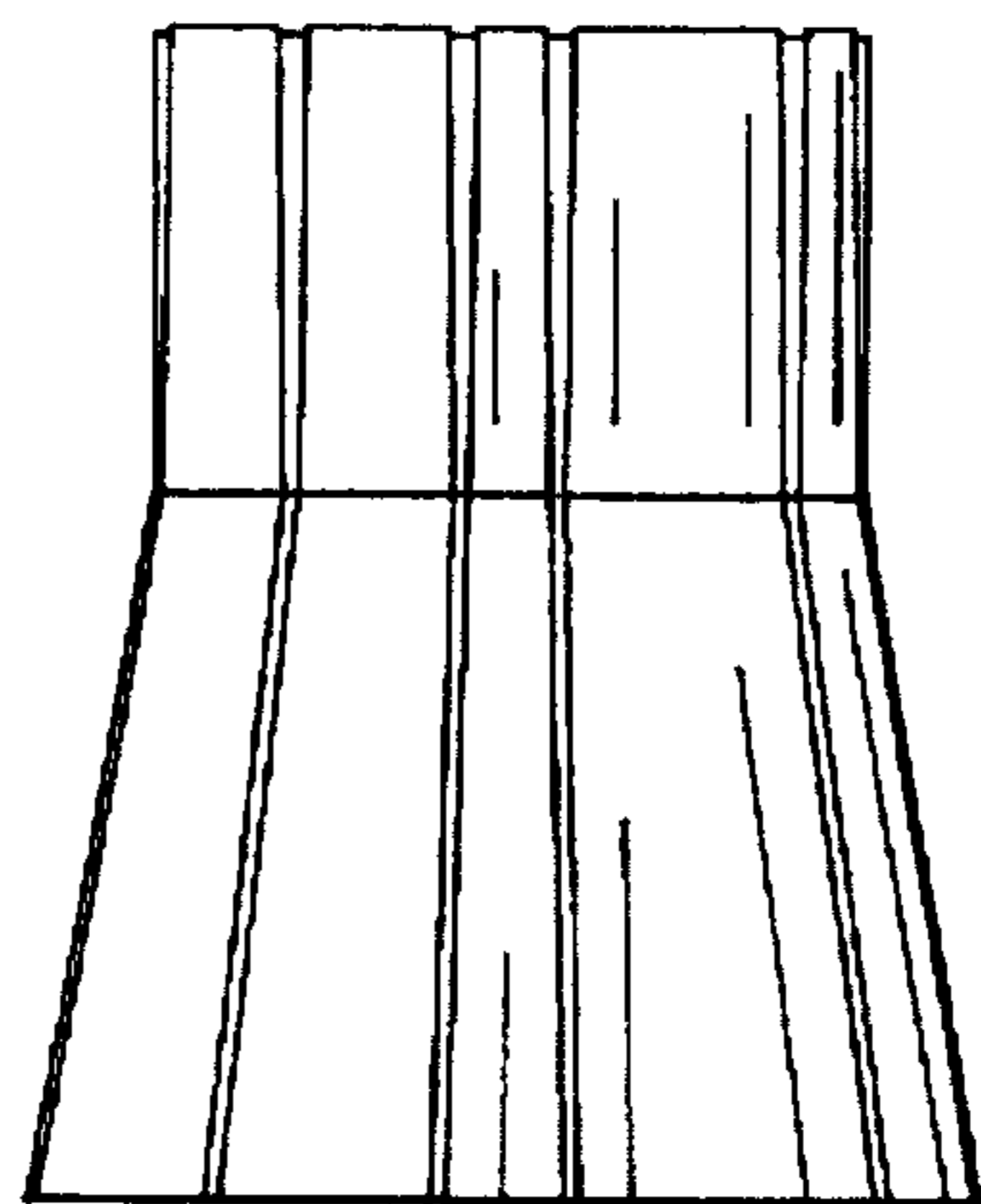

FIG. 20

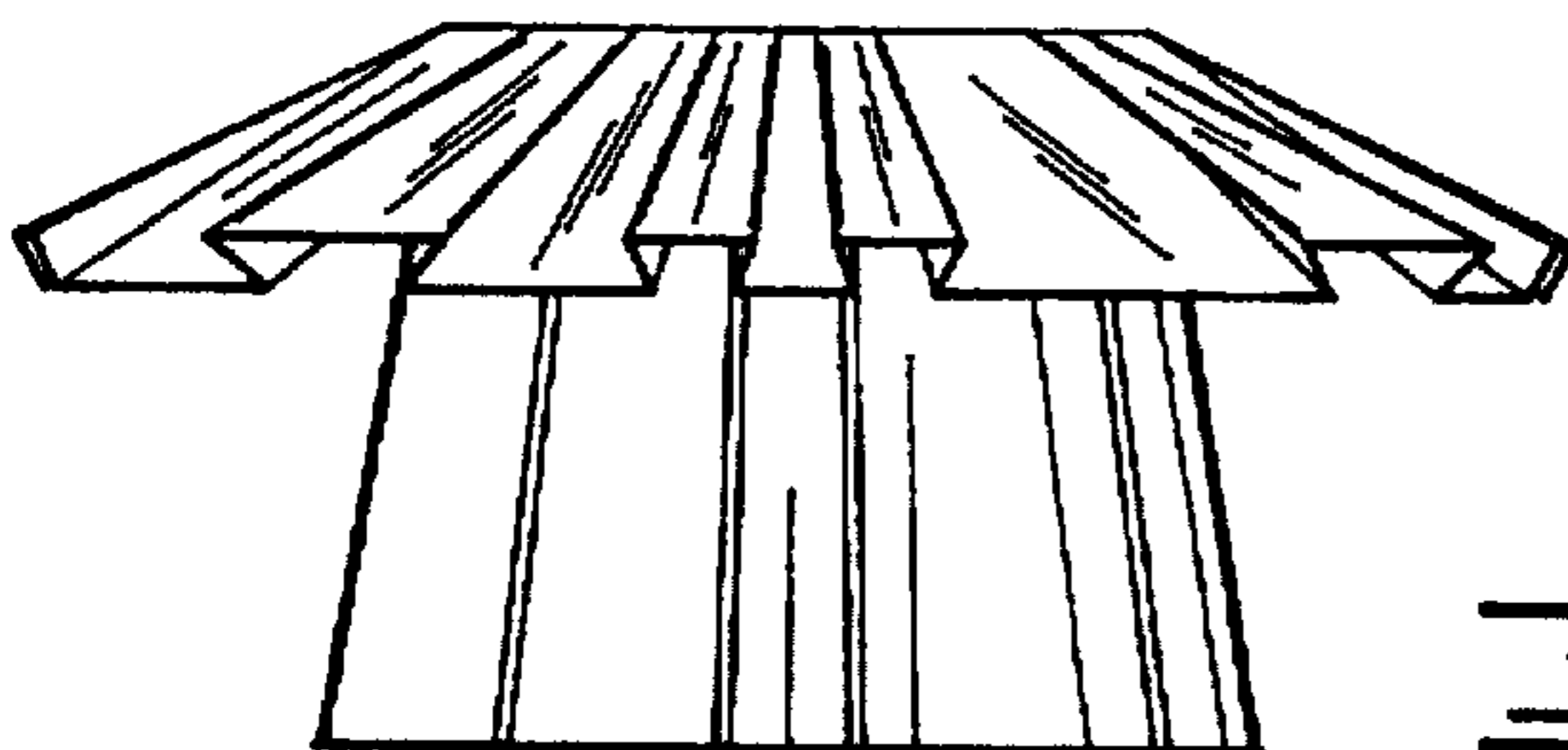

FIG. 21

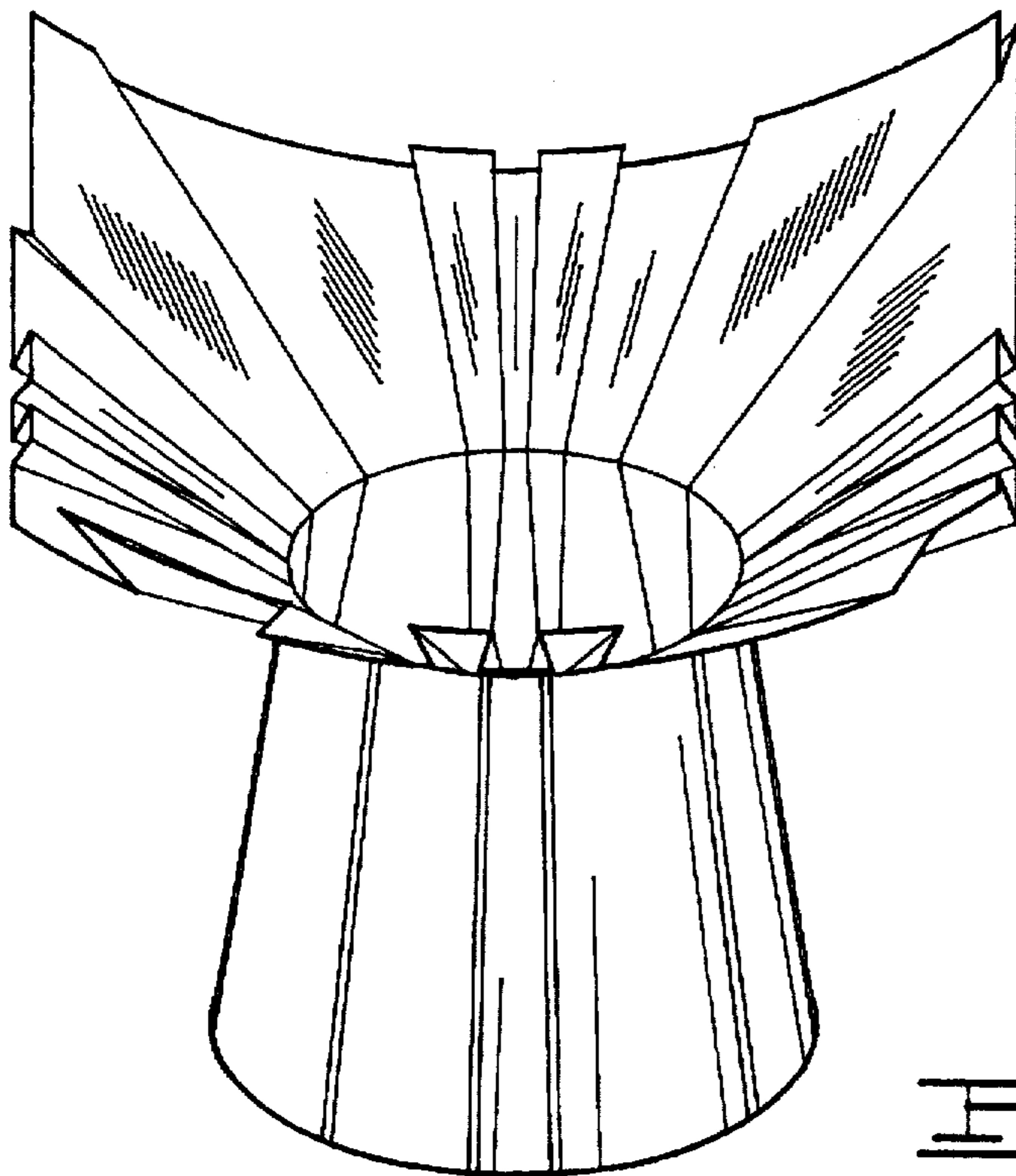

FIG. 22

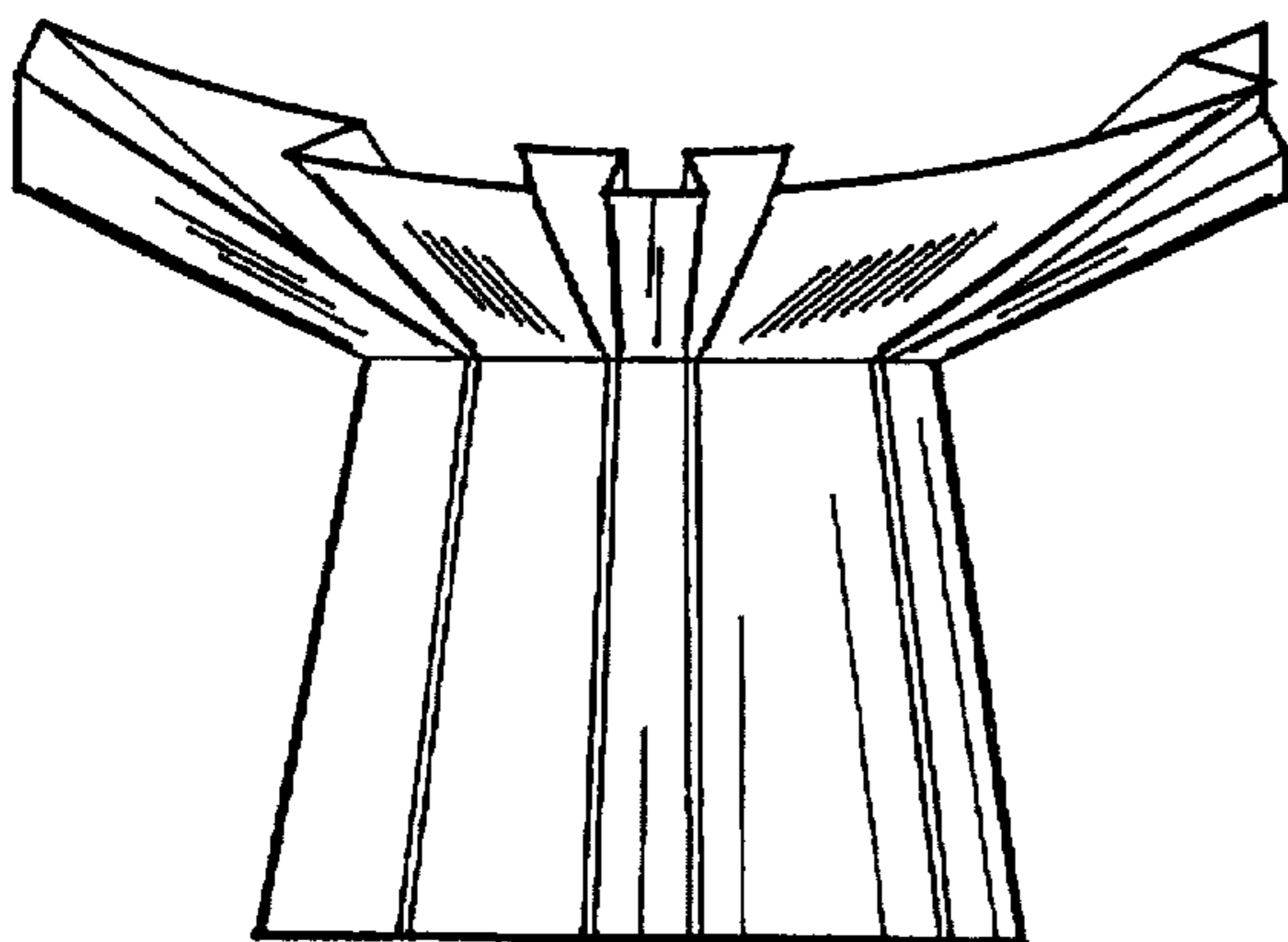

FIG. 23

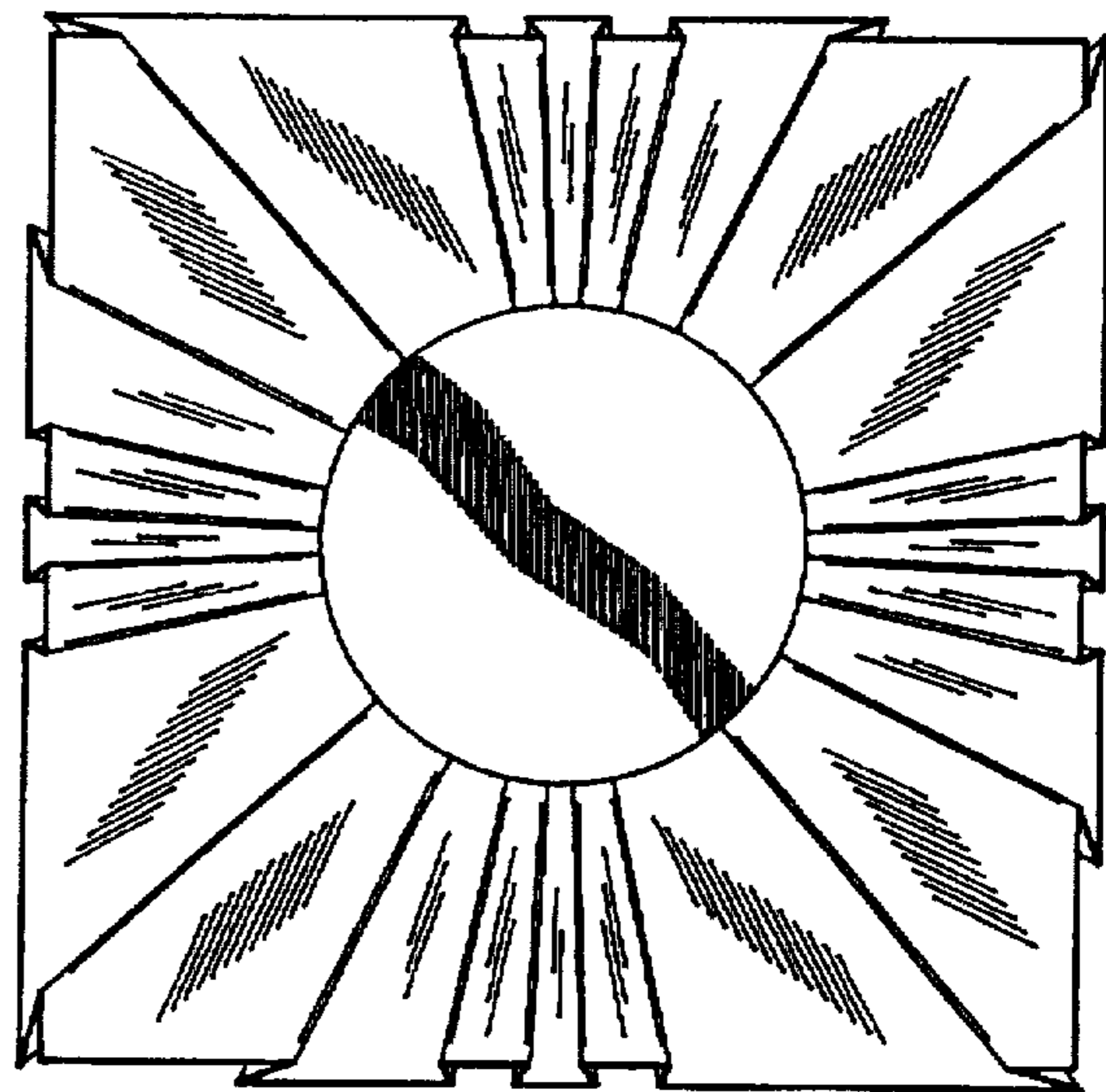

FIG. 24

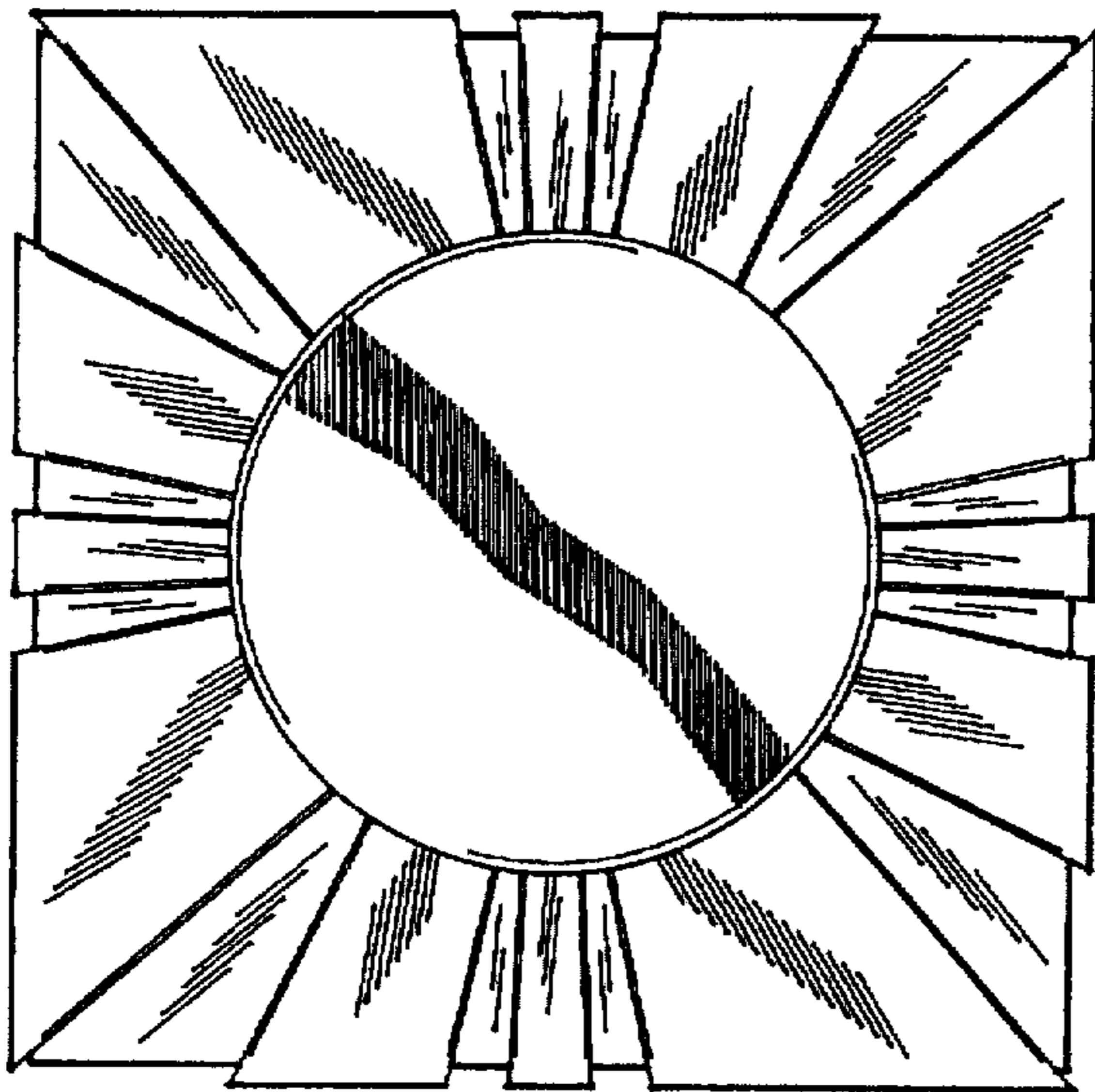

FIG. 25

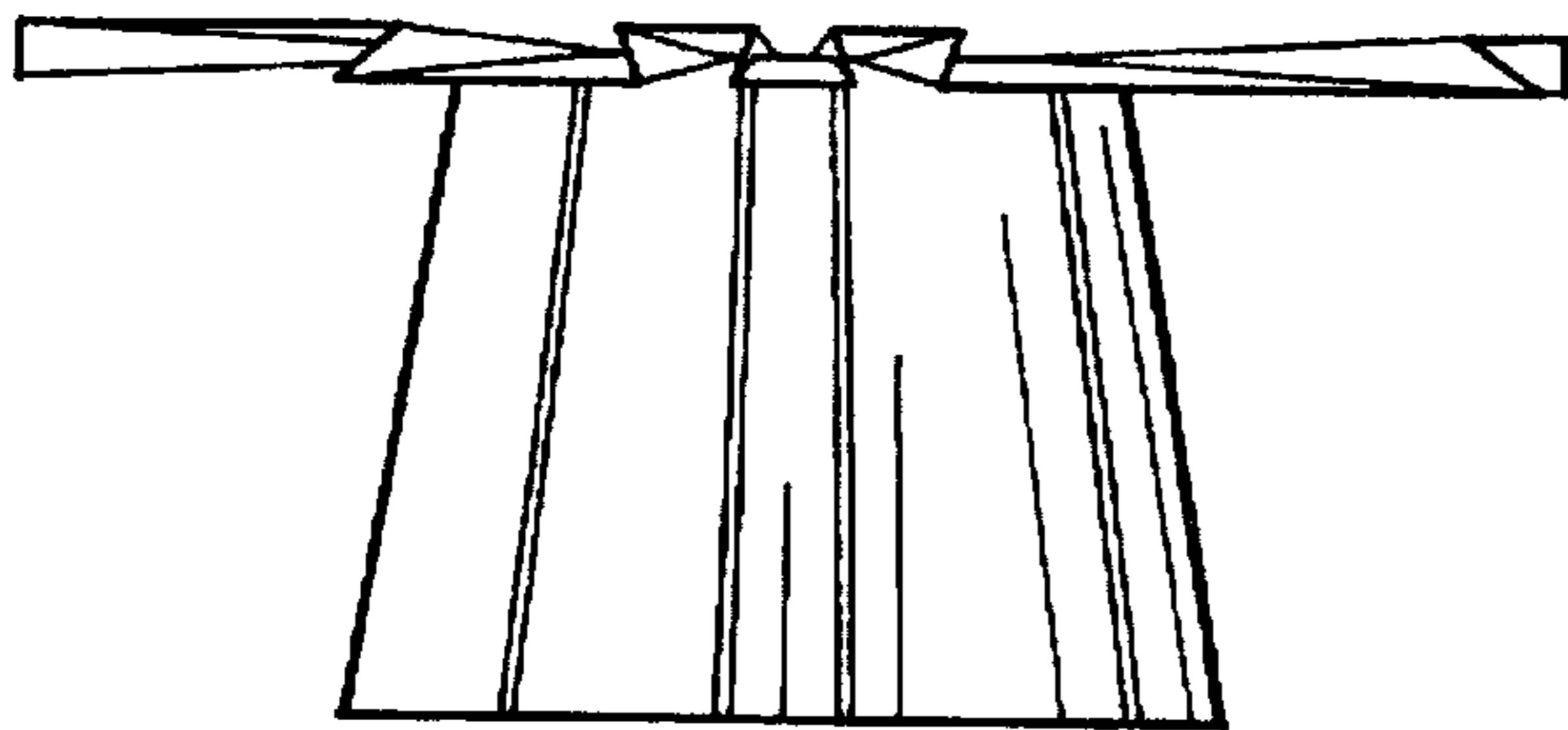

FIG. 26

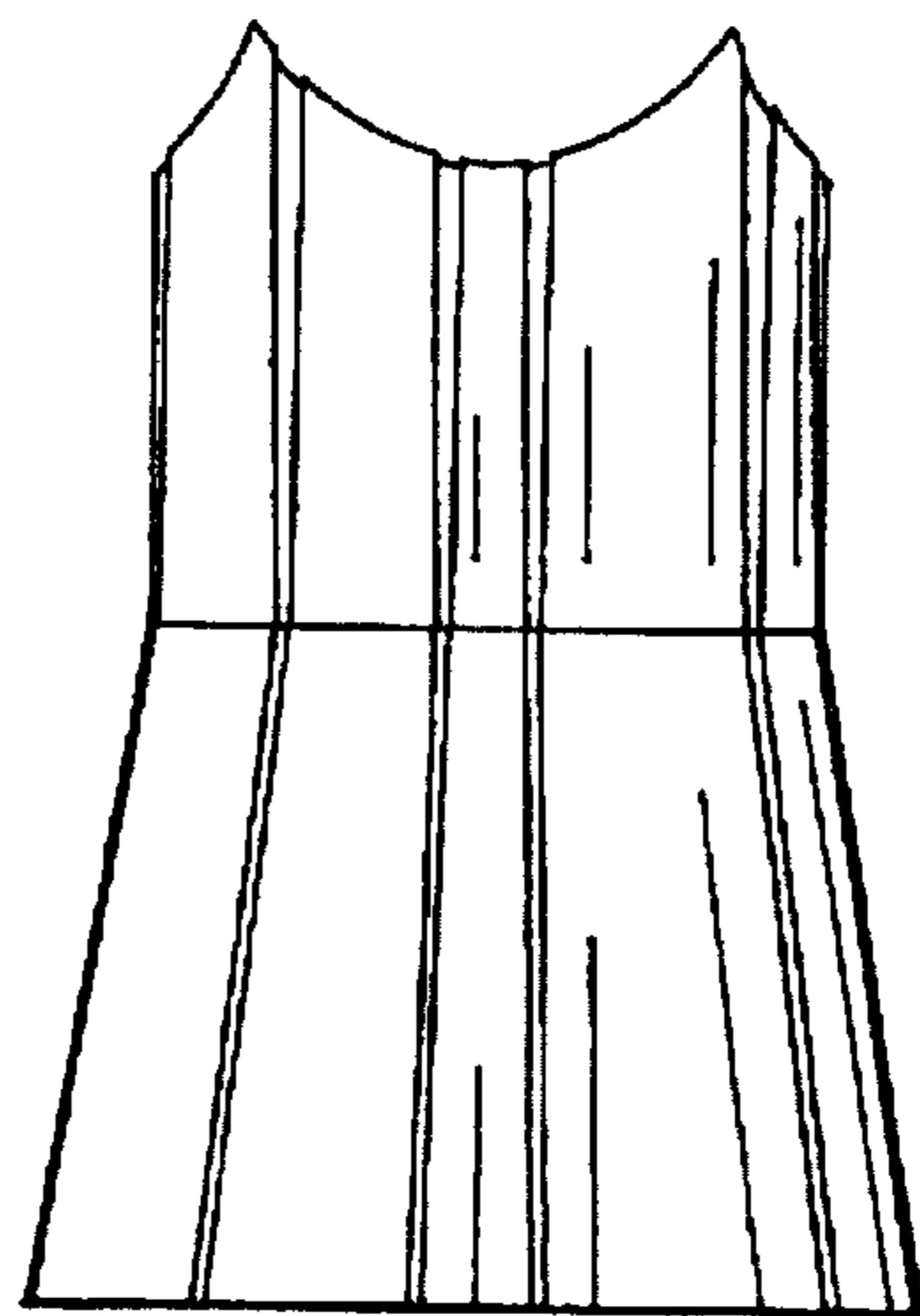

FIG. 27

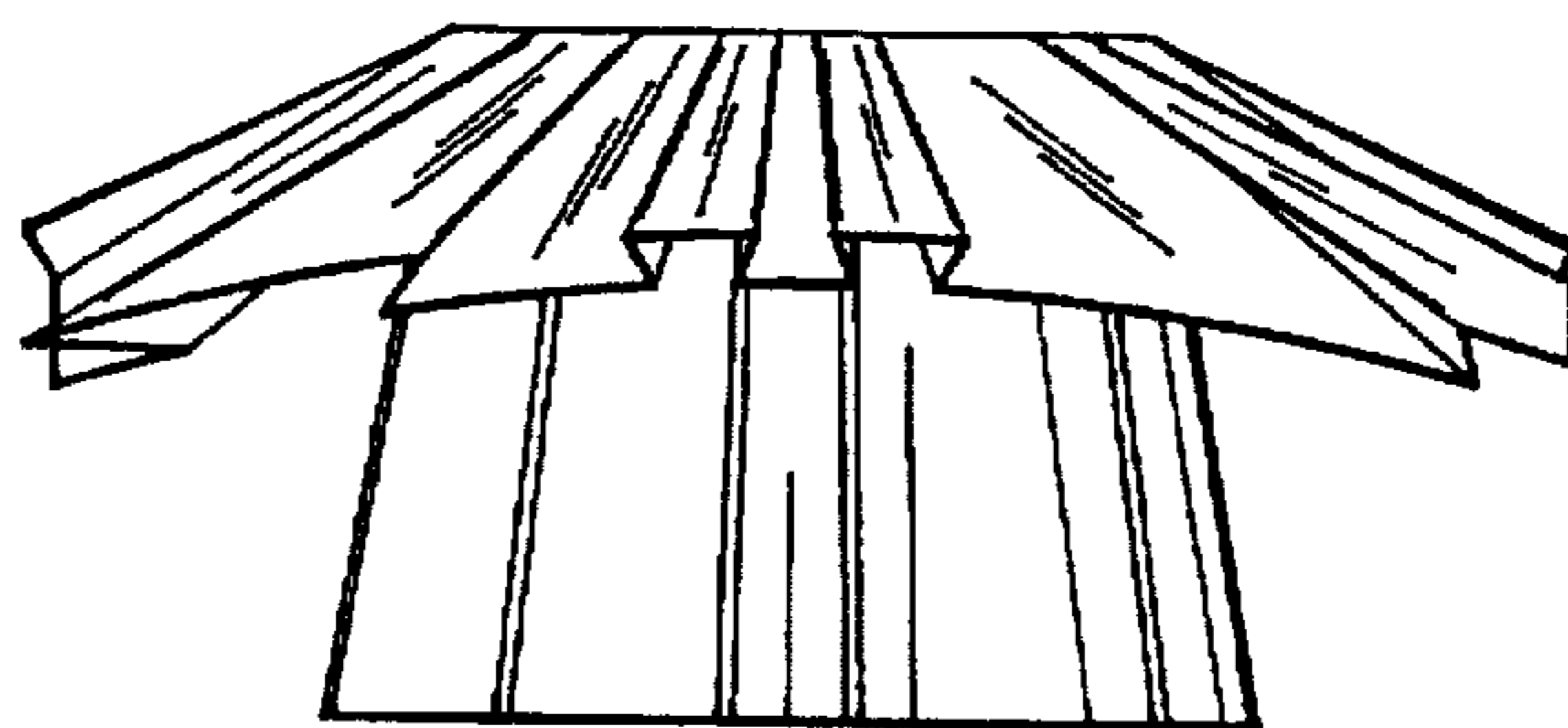

FIG. 28

UNITED STATES PATENT AND TRADEMARK OFFICE
CERTIFICATE OF CORRECTION

PATENT NO. : Des. 385,822
DATED : November 4, 1997
INVENTOR(S) : Donald E. Weder et al.

It is certified that error appears in the above-identified patent and that said Letters Patent is hereby corrected as shown below:

Cover Sheet, under [56] References Cited U.S. PATENT DOCUMENTS, please insert:

--D 352,918	11/1994	Weder et al.	D11/164
D 356,755	3/1995	Weder et al.	D11/164
D 358,565	5/1995	Weder et al.	D11/164
D 358,566	5/1995	Weder et al.	D11/164
D 364,584	11/1995	Weder et al.	D11/164
D 366,630	1/1996	Weder et al.	D11/164
D 370,644	6/1996	Weder et al.	D11/164
D 371,091	6/1996	Weder et al.	D11/164
D 371,519	7/1996	Weder et al.	D11/164

Signed and Sealed this
Twenty-fourth Day of March, 1998

Attest:



BRUCE LEHMAN

Attesting Officer

Commissioner of Patents and Trademarks