



US00D385681S

United States Patent [19] Worden

[11] Patent Number: Des. 385,681

[45] Date of Patent: ***Oct. 28, 1997

[54] **COMBINED MAIL, NEWSPAPER AND
PARCEL DELIVERY BOX**

4,602,721 7/1986 Hicks 220/337
4,848,650 7/1989 Roberts 232/17

[76] Inventor: **Thomas C. Worden**, 4608 Wye Way
La. SW., Knoxville, Tenn. 37920

FOREIGN PATENT DOCUMENTS

463060 2/1950 Canada .

[*] Notice: The portion of the term of this patent
subsequent to Sep. 19, 2009, has been
disclaimed.

Primary Examiner—B. J. Bullock
Assistant Examiner—Robert M. Spear
Attorney, Agent, or Firm—Pitts & Brittan, P.C.

[**] Term: **14 Years**

[57] CLAIM

[21] Appl. No.: **33,598**

The ornamental design of a combined mail, newspaper and
parcel delivery box, as shown and described.

[22] Filed: **Jan. 17, 1995**

DESCRIPTION

Related U.S. Application Data

[63] Continuation-in-part of Ser. No. 9,967, Jun. 28, 1993, Pat.
No. Des. 362,533, which is a continuation-in-part of Ser. No.
9,085, Jun. 4, 1993, Pat. No. Des. 354,612, and Ser. No.
71,542, Jun. 4, 1993, Pat. No. 5,407,127.

FIG. 1 is a perspective view of a combined mail, newspaper
and parcel delivery box showing my new design;

FIG. 2 is a front elevation view thereof;

FIG. 3 is a right side elevation view thereof;

FIG. 4 is a left side elevation view thereof;

FIG. 5 is a rear elevation view thereof;

FIG. 6 is a top plan view thereof;

FIG. 7 is a bottom plan view thereof;

FIG. 8 is a perspective view of an alternate embodiment of
a combined mail, newspaper and parcel delivery box show-
ing my new design;

FIG. 9 is a front elevation view thereof;

FIG. 10 is a right side elevation view thereof;

FIG. 11 is a left side elevation view thereof;

FIG. 12 is a rear elevation view thereof;

FIG. 13 is a top plan view thereof; and,

FIG. 14 is a bottom plan view thereof.

The broken lines in FIGS. 1-5, 7-12 and 14 form no part of
the ornamental design.

[51] LOC (6) Cl. **99-00**

[52] U.S. Cl. **D99/31**

[58] Field of Search D99/29, 30, 31,
D99/32; 232/1 R, 1 C, 7, 14, 17, 19, 20,
29, 32, 39, 43

[56] References Cited

U.S. PATENT DOCUMENTS

D. 254,635 4/1980 Earle D99/33
D. 263,514 3/1982 Paparella D99/32
D. 313,106 12/1990 Hoffman et al. D99/29
D. 324,444 3/1992 Cummings D99/31
4,333,603 6/1982 Carlson 232/17

1 Claim, 8 Drawing Sheets

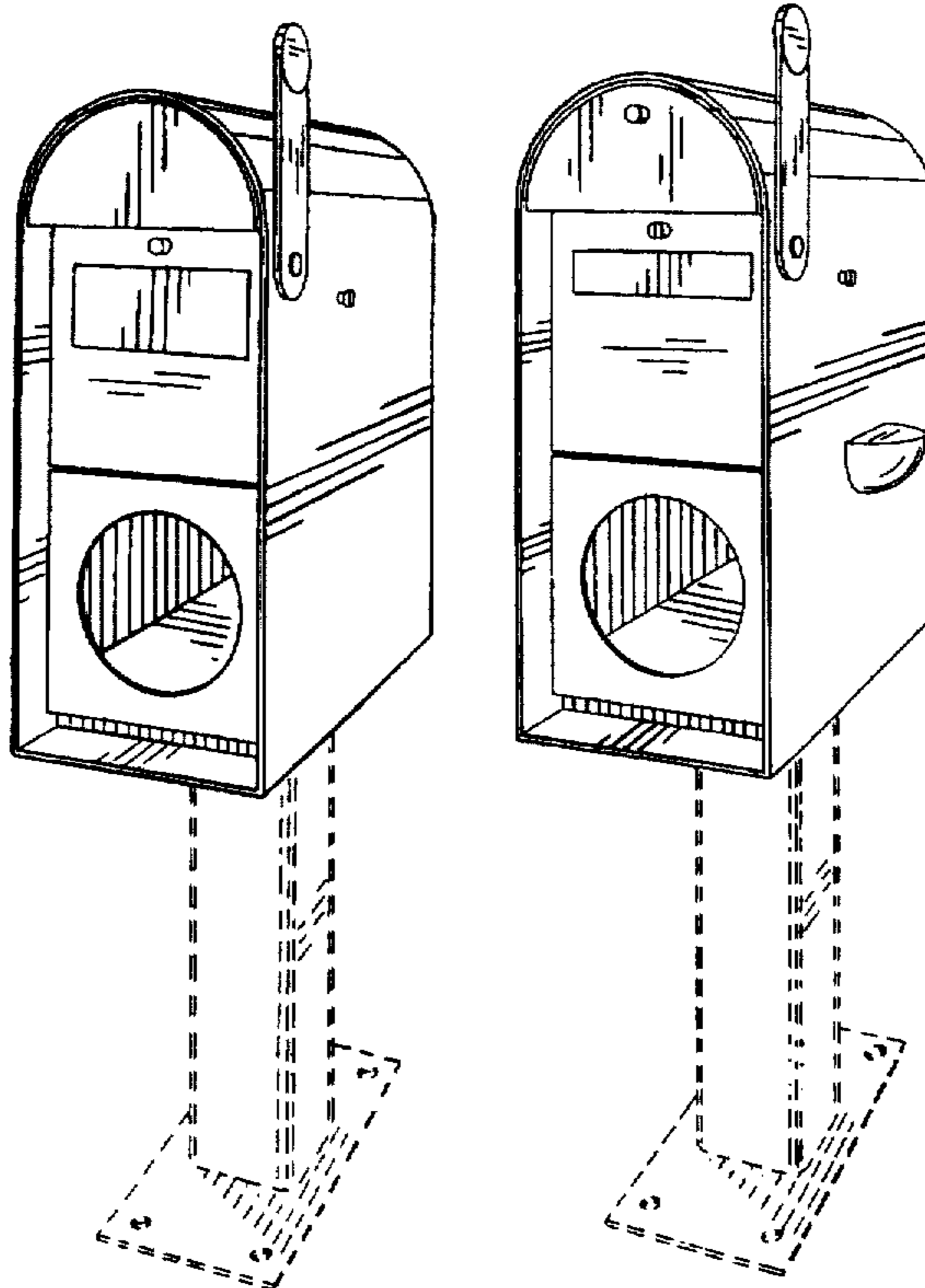

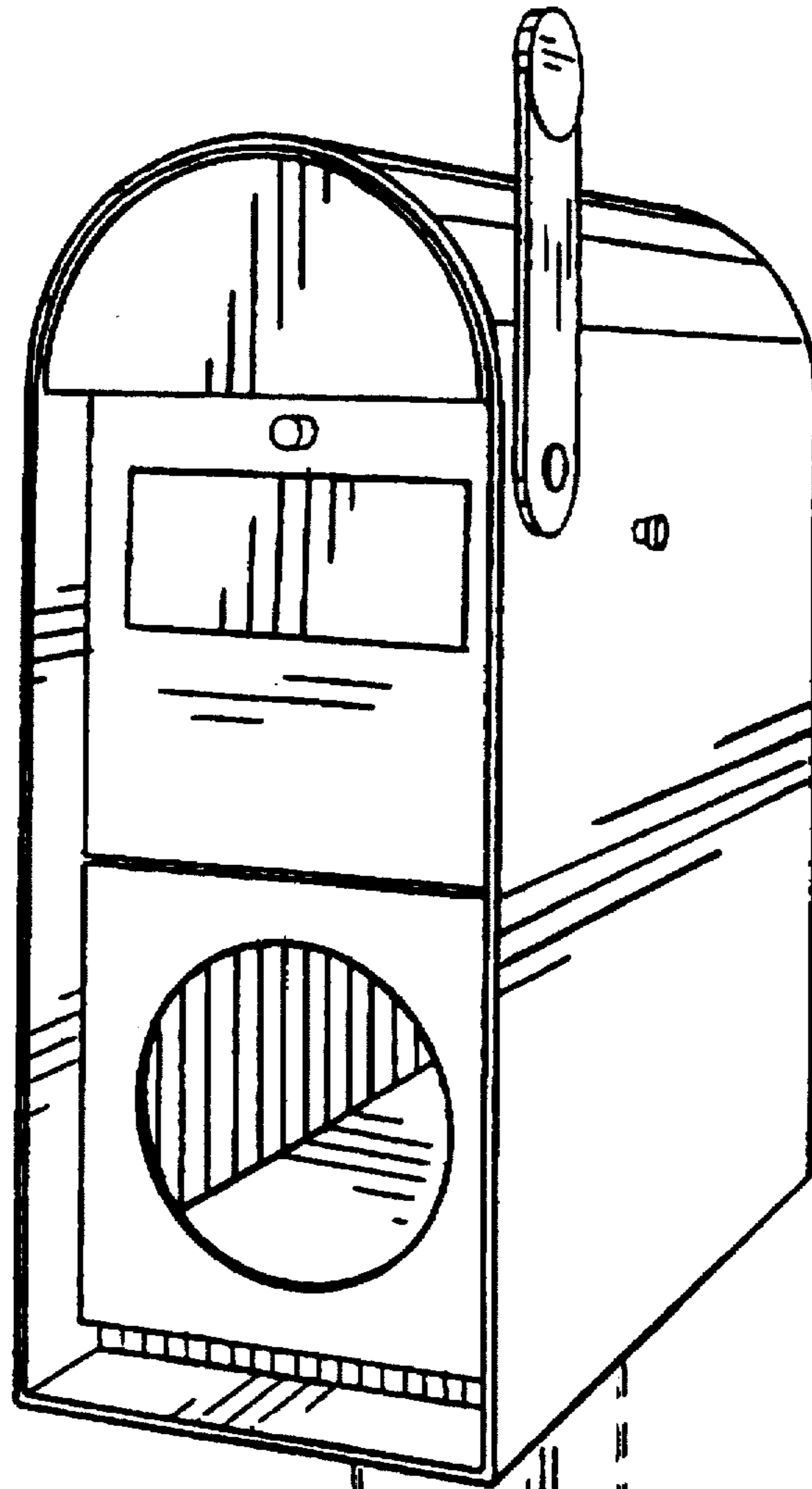
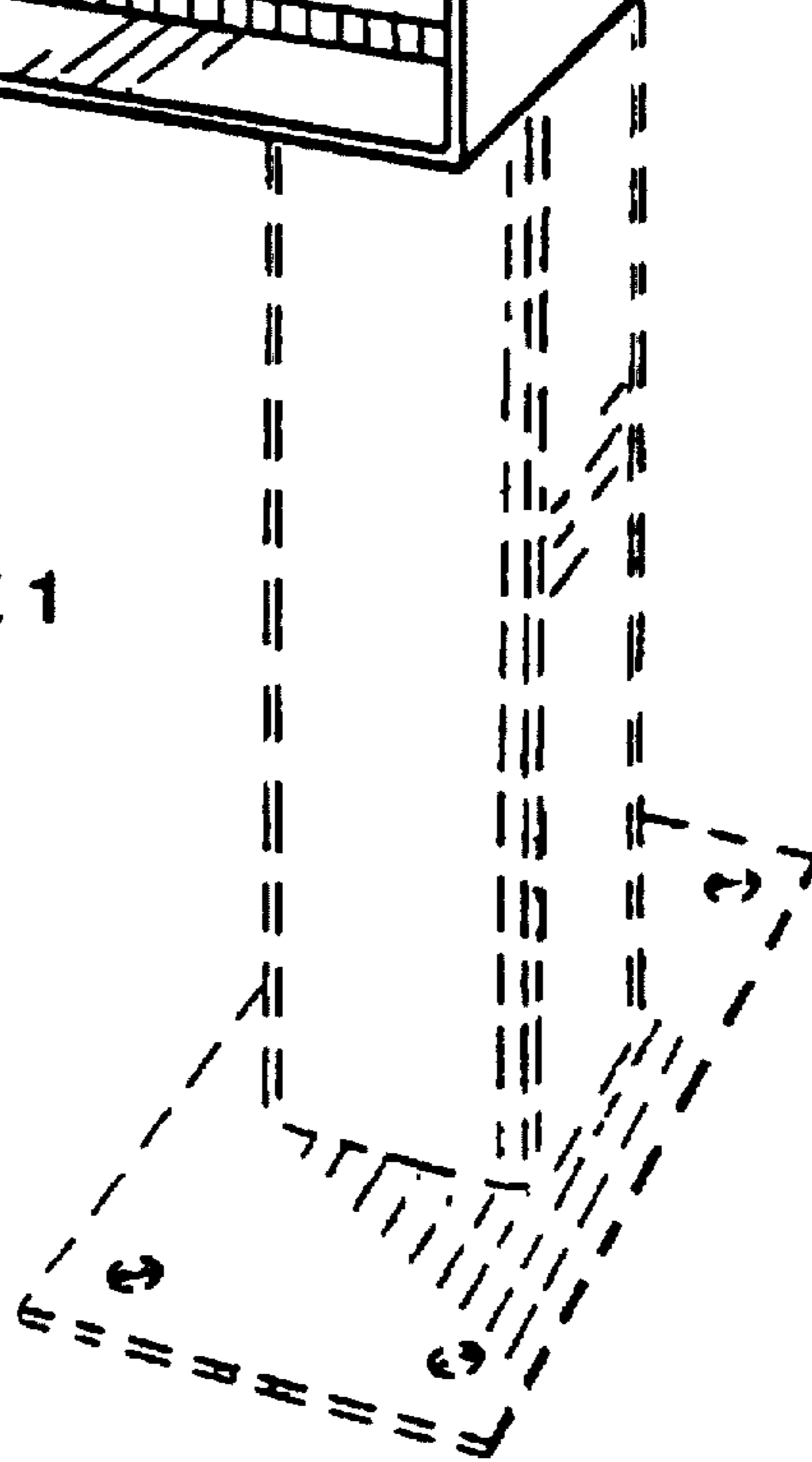

FIGURE 1



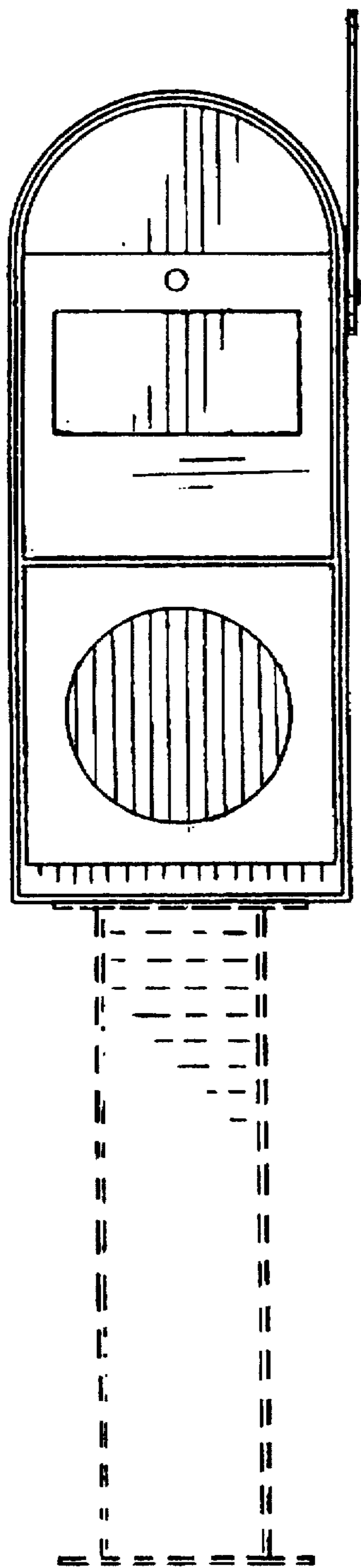

FIGURE 2

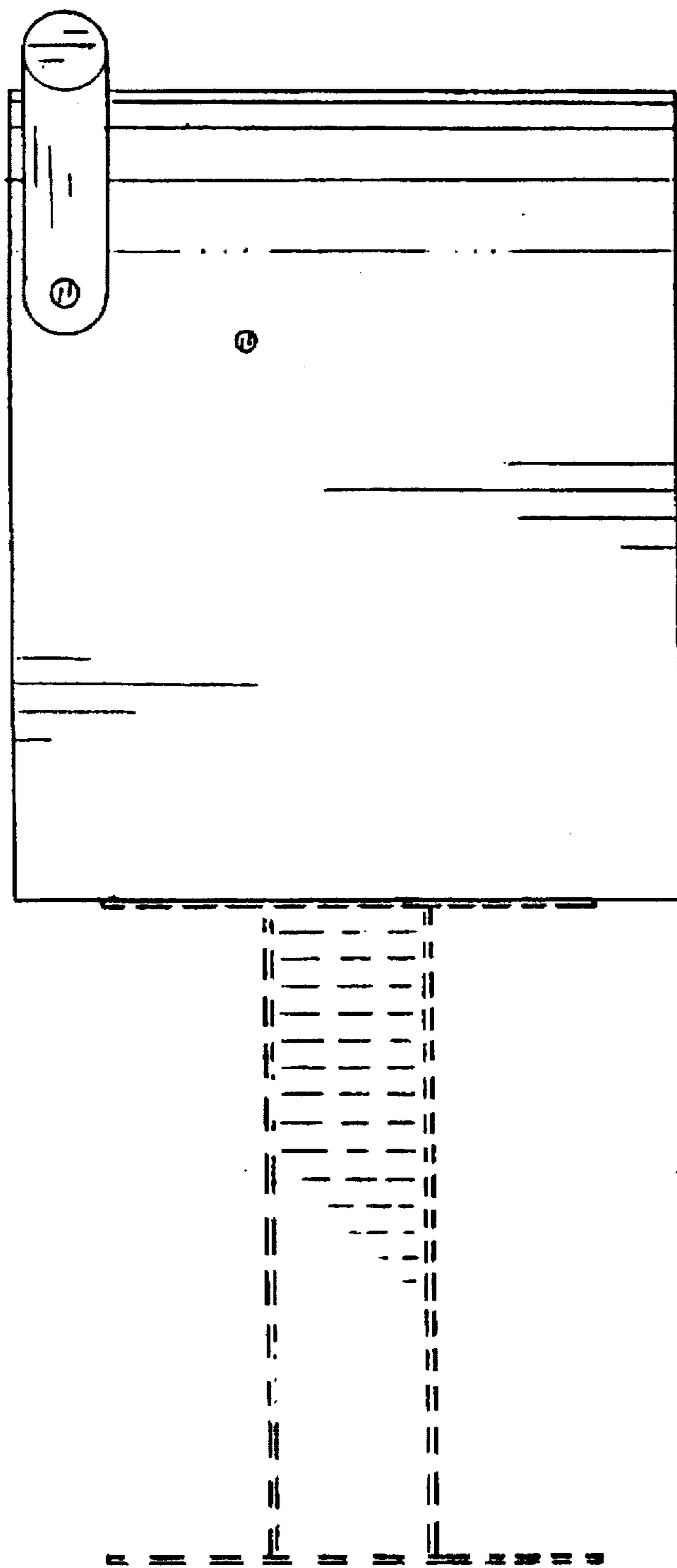

FIGURE 3

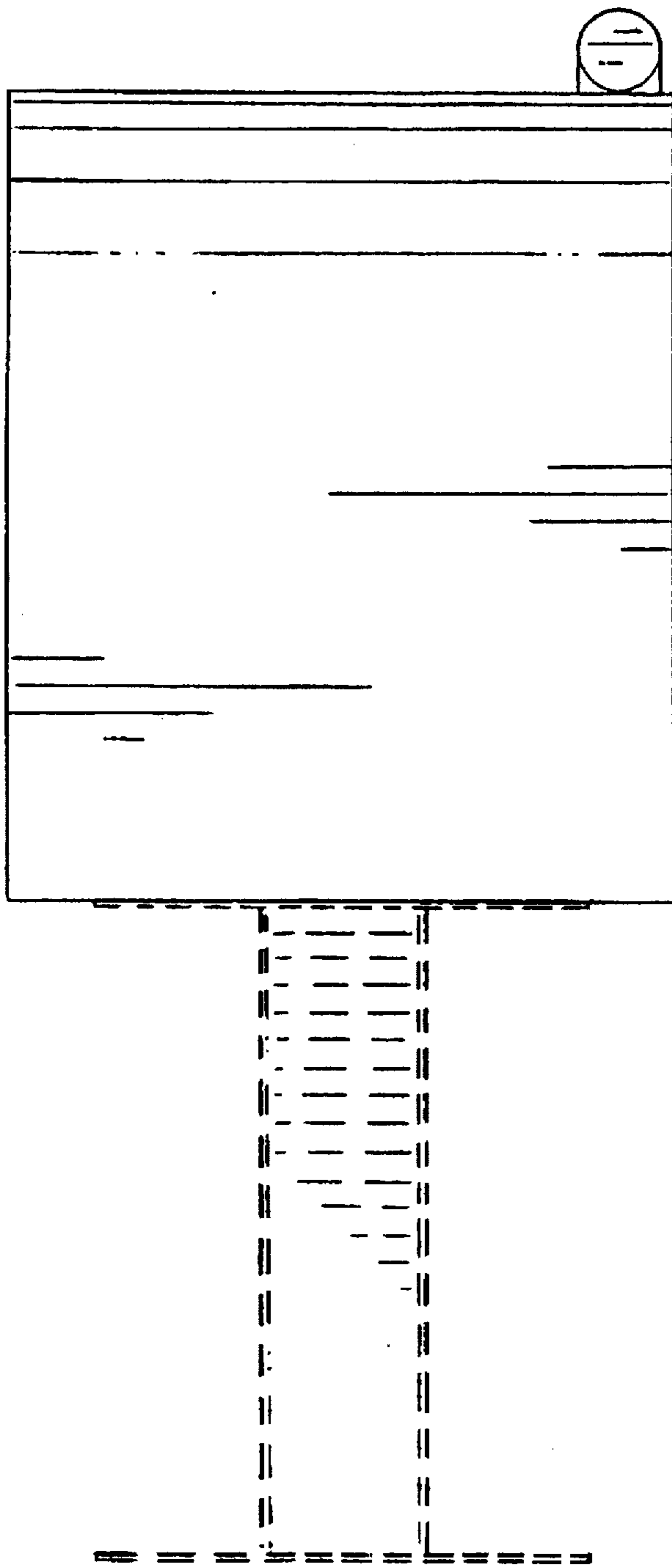

FIGURE 4

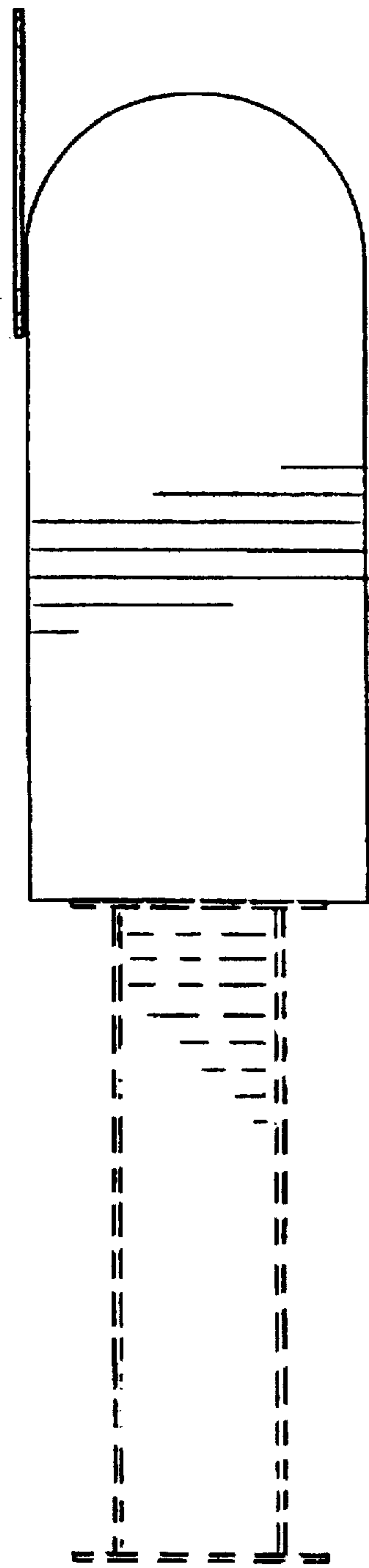

FIGURE 5

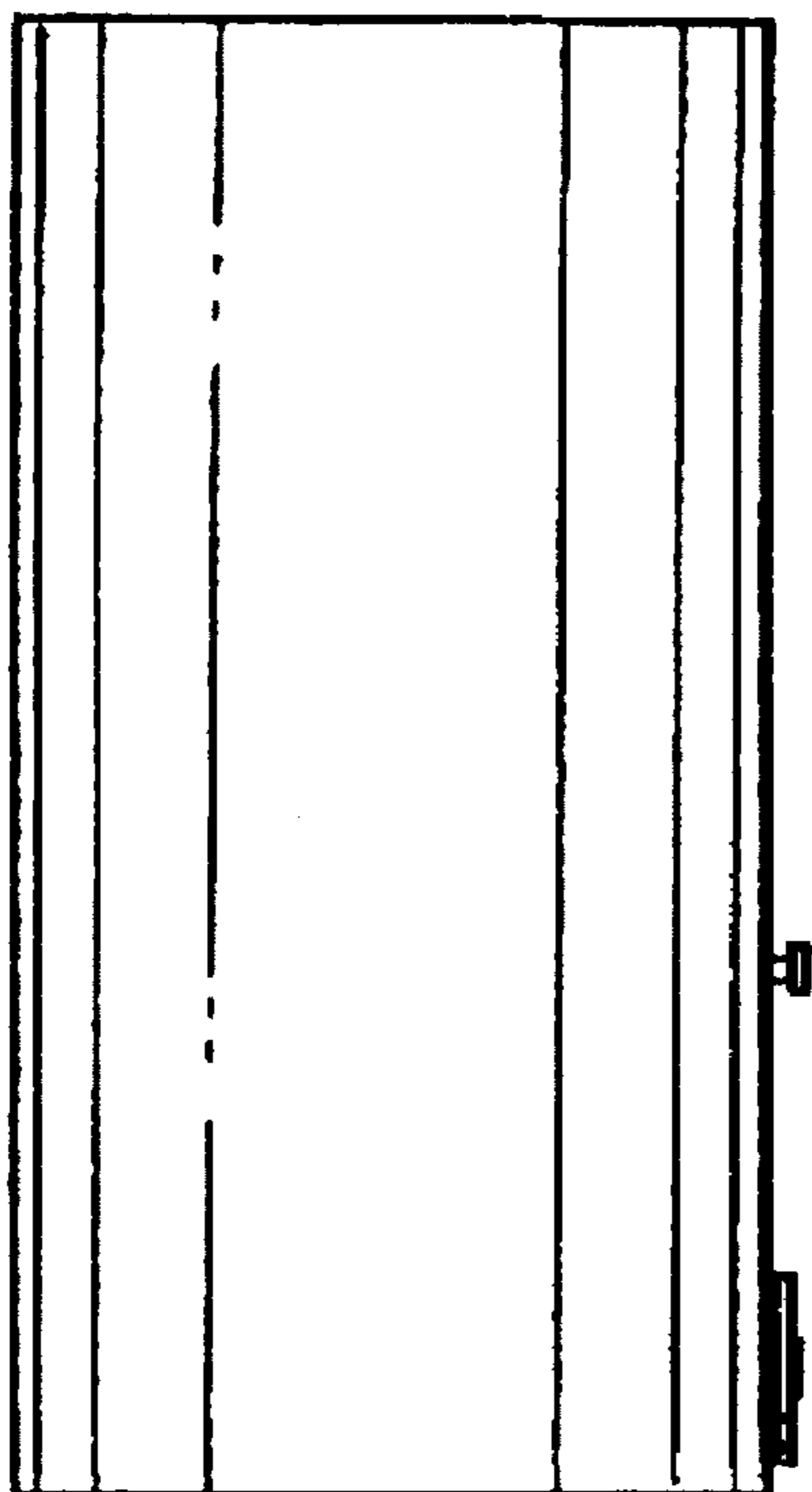

FIGURE 6

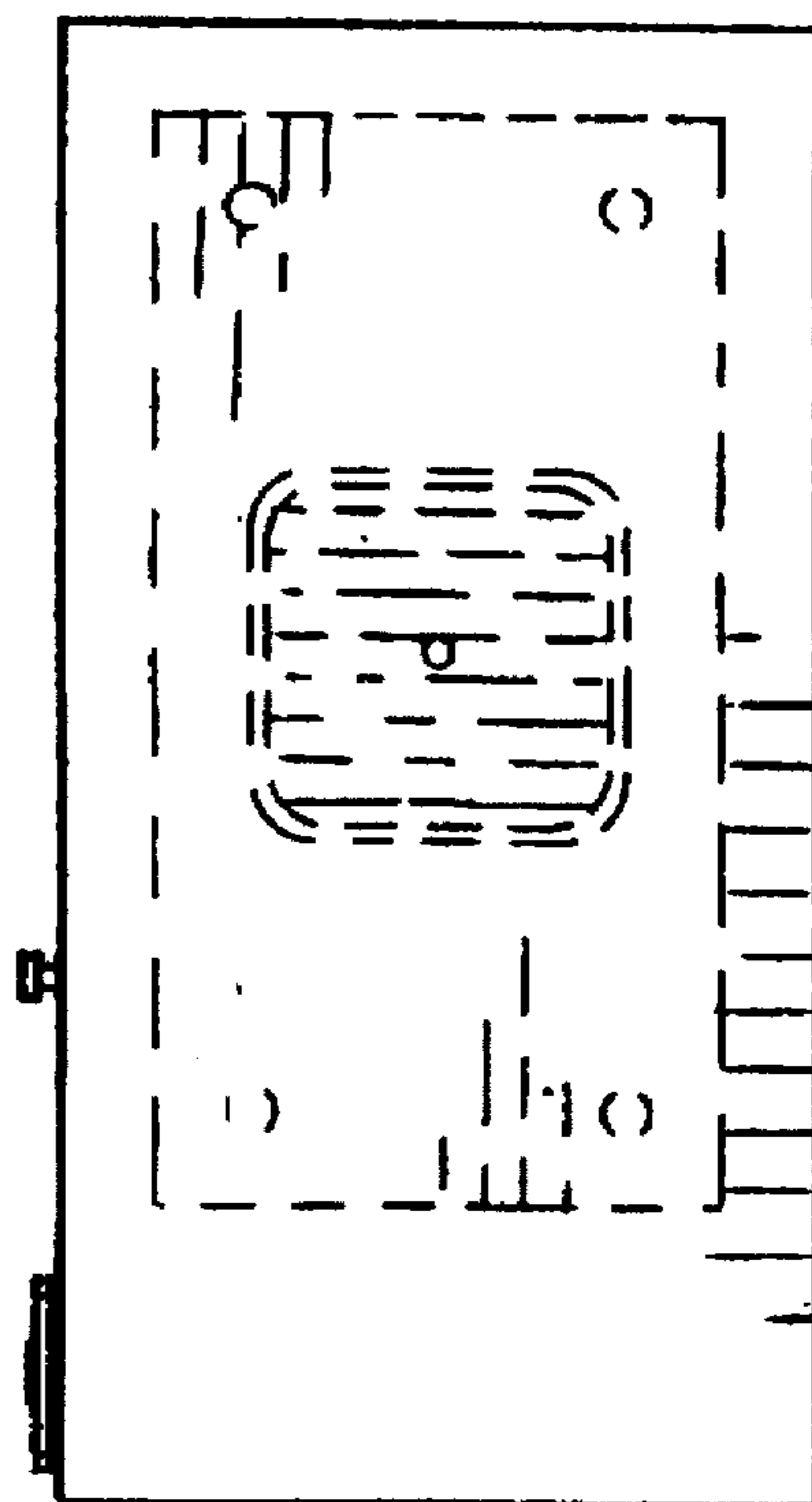

FIGURE 7

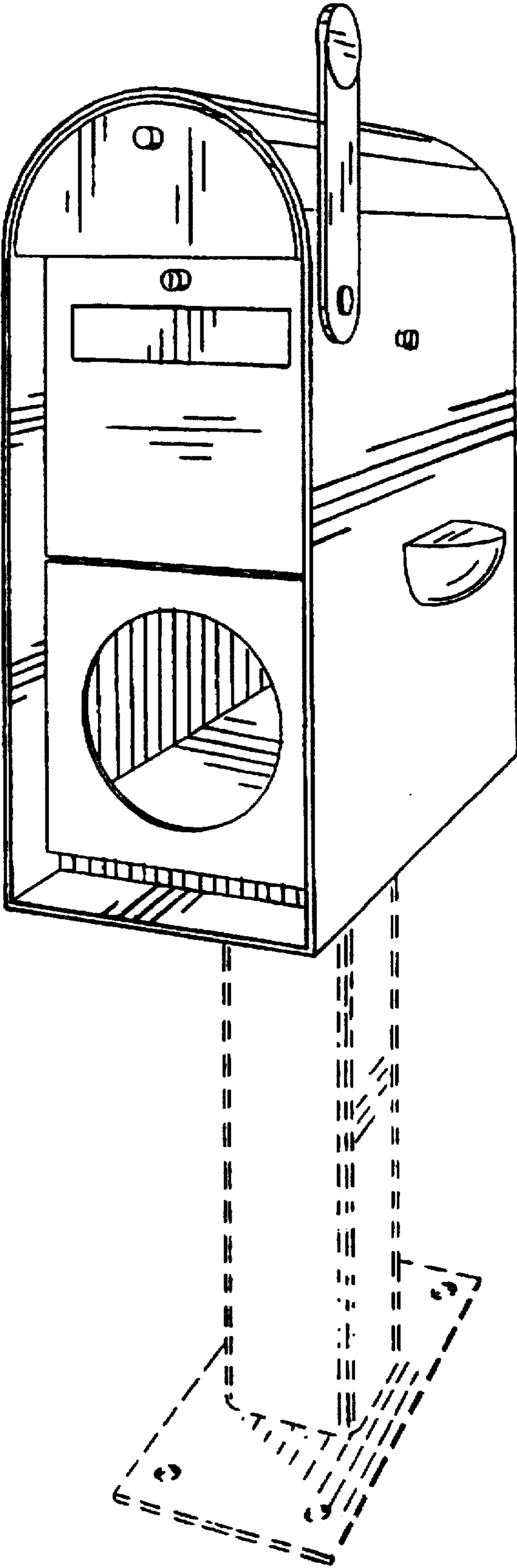

FIGURE 8

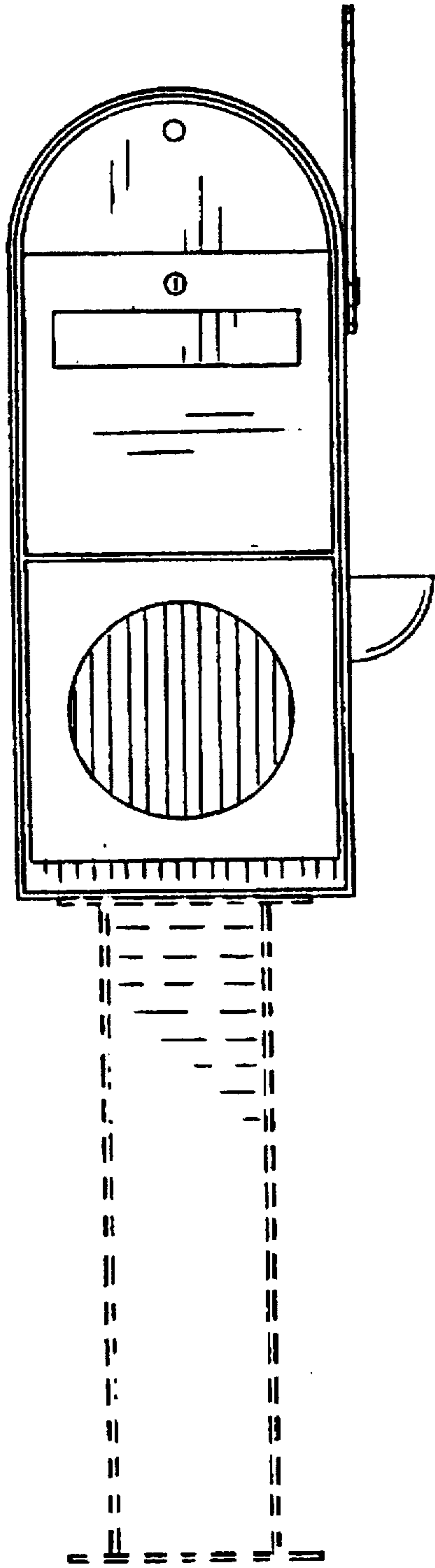

FIGURE 9

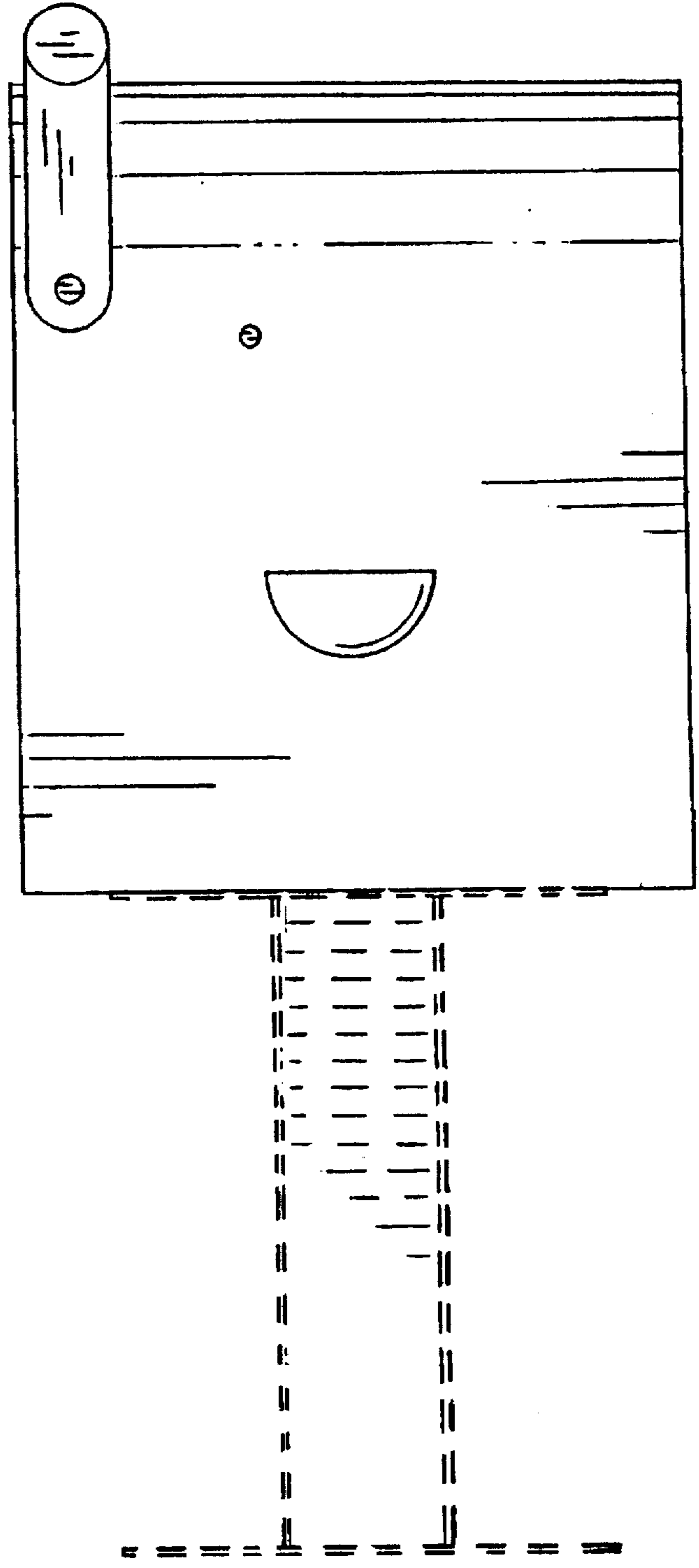

FIGURE 10

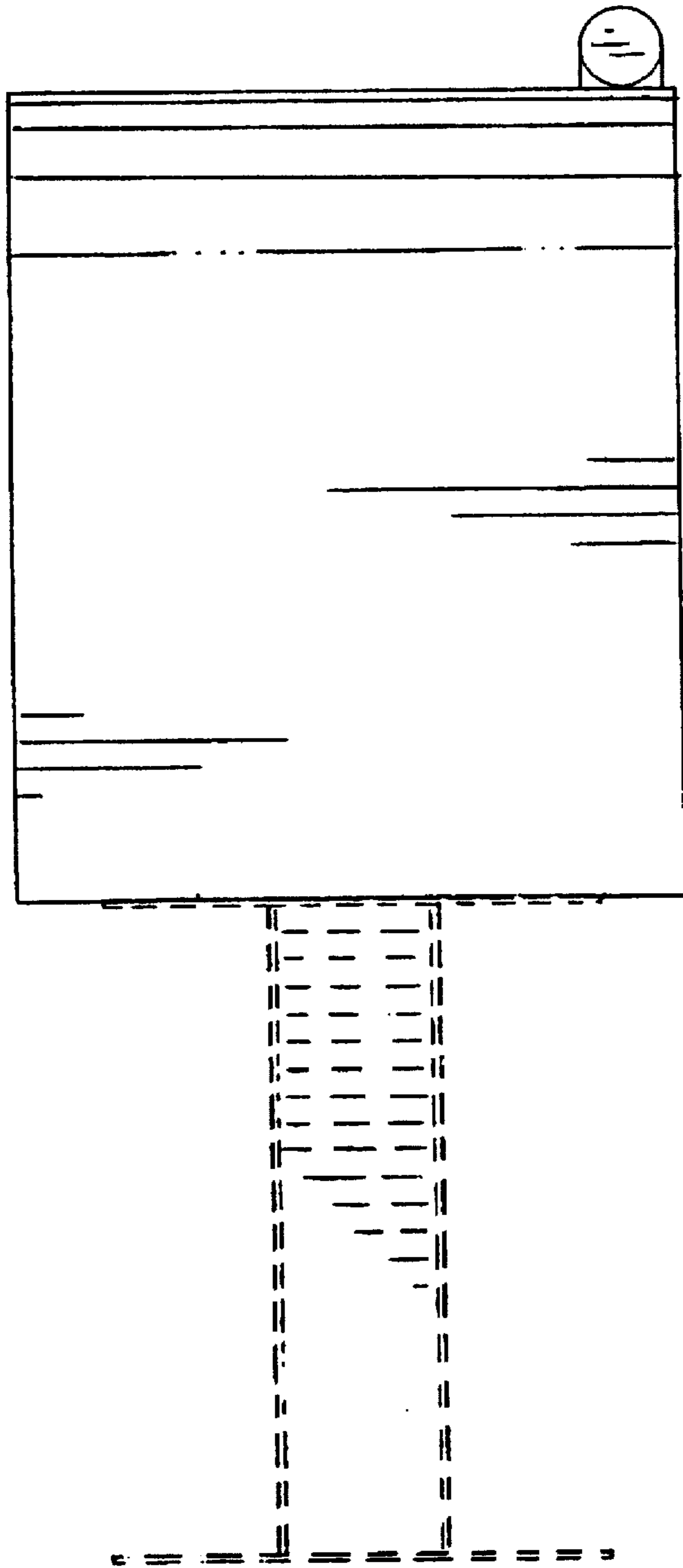

FIGURE 11

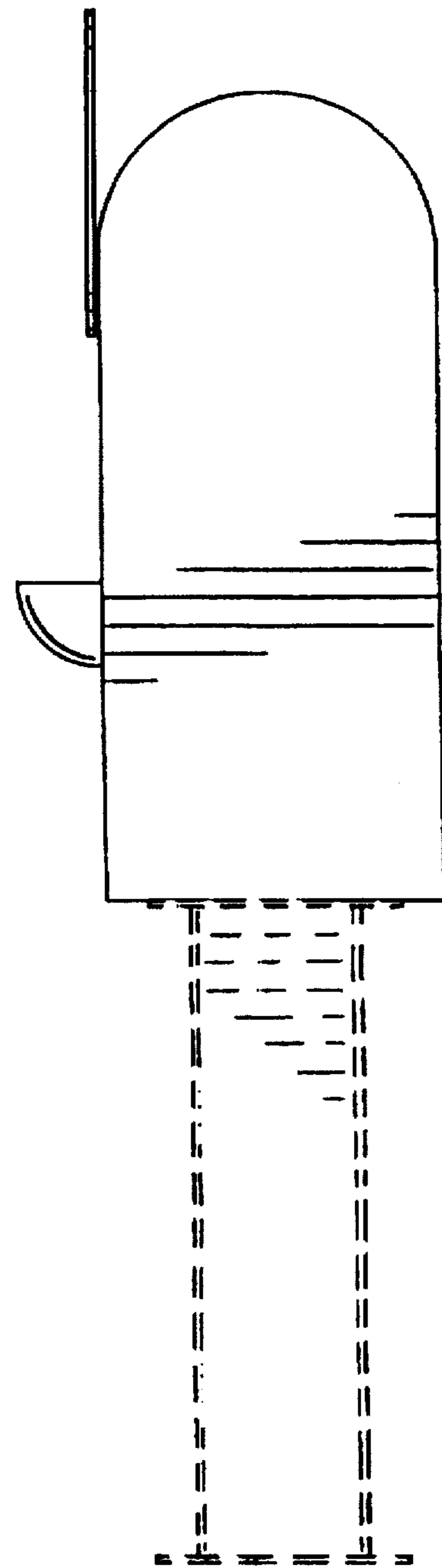

FIGURE 12

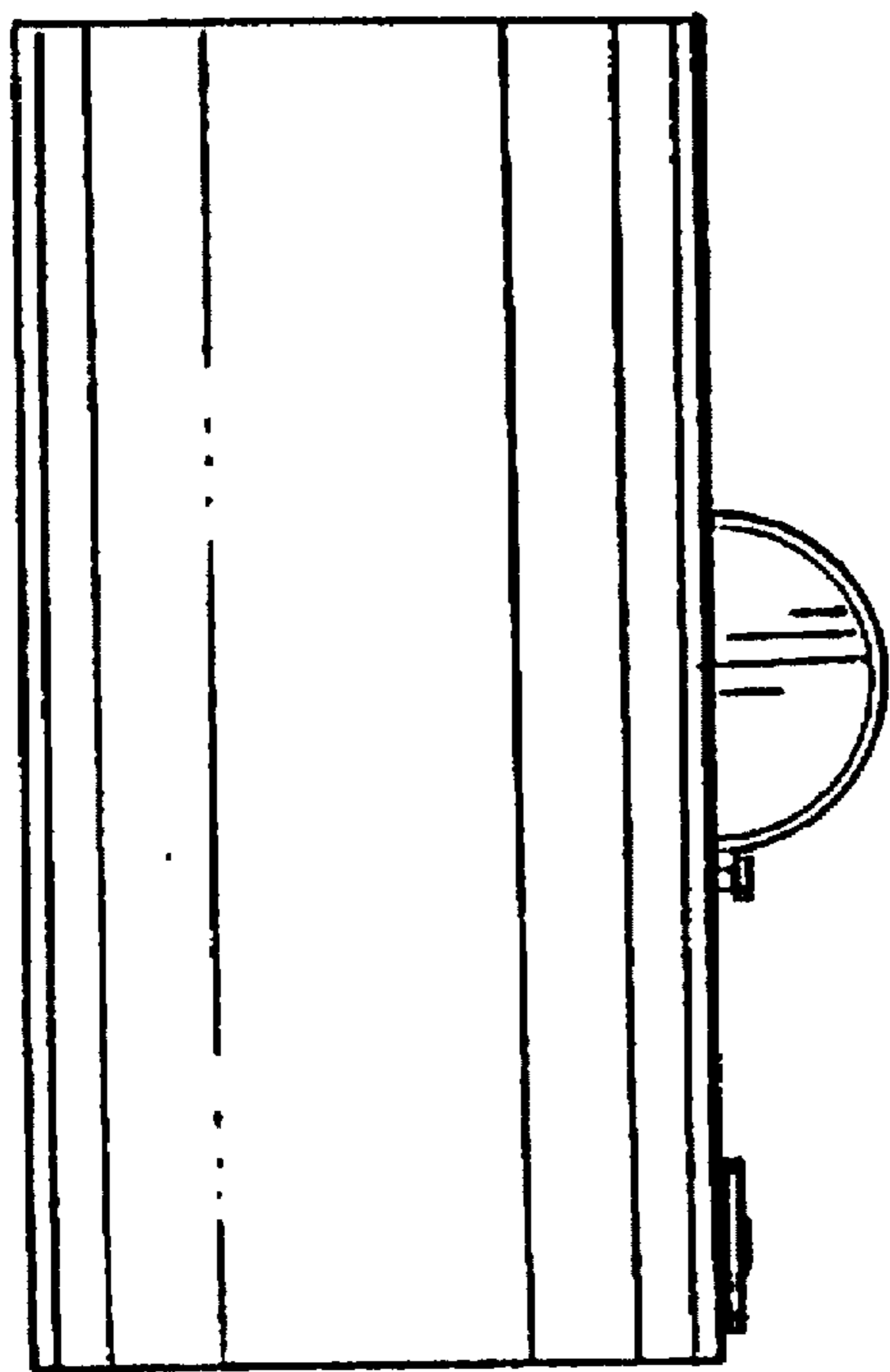

FIGURE 13

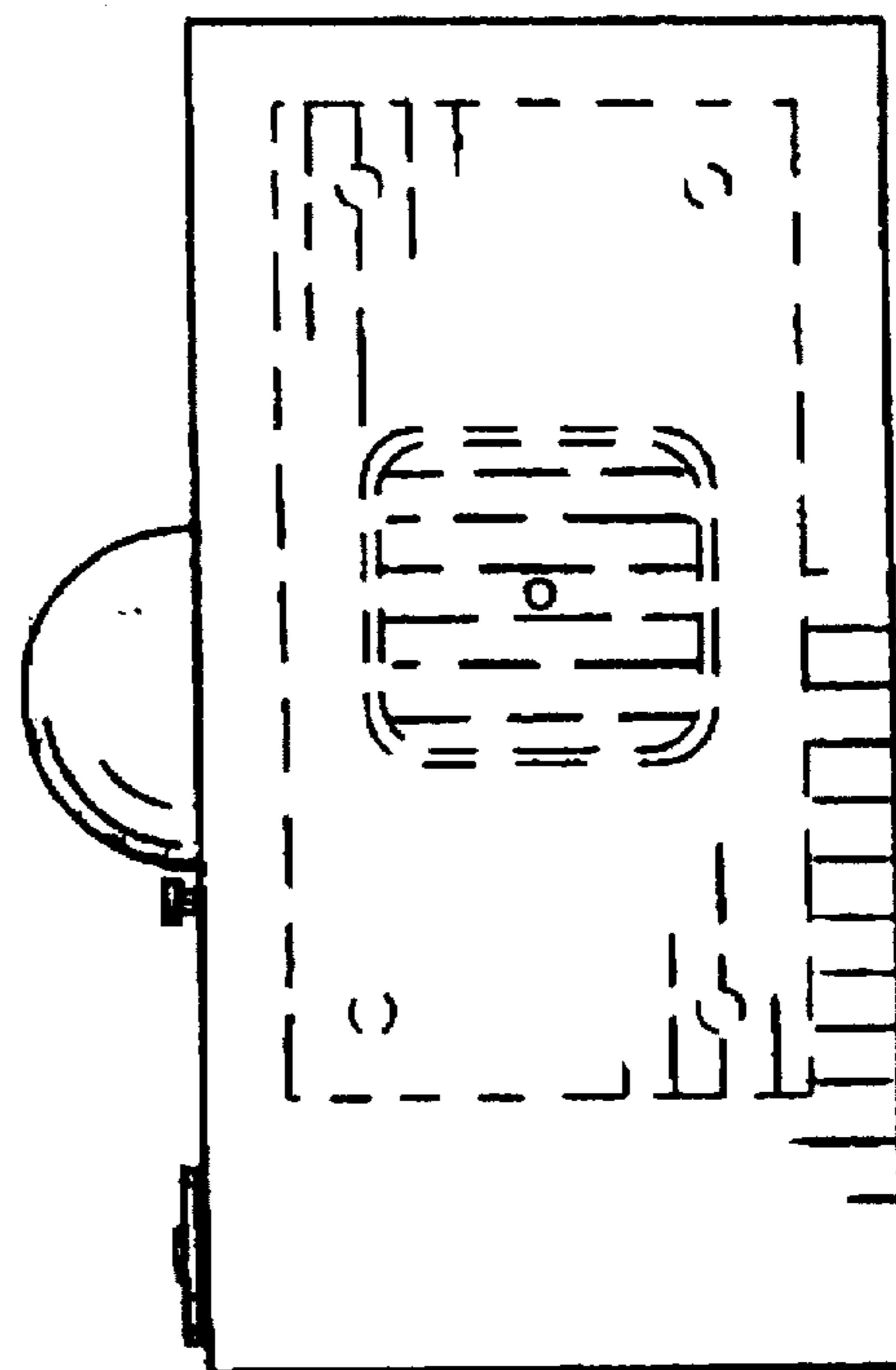

FIGURE 14