



US00D385653S

United States Patent [19]
Wicker

[11] **Patent Number:** **Des. 385,653**
[45] **Date of Patent:** ****Oct. 28, 1997**

[54] **HUMIDOR**
[75] **Inventor:** **Kenneth Wicker, Louisville, Ky.**
[73] **Assignee:** **Bakar Associates, Inc., Louisville, Ky.**
[**] **Term:** **14 Years**
[21] **Appl. No.:** **59,649**
[22] **Filed:** **Jul. 29, 1996**
[51] **LOC (6) Cl.** **27-06**
[52] **U.S. Cl.** **D27/187**
[58] **Field of Search** 312/31.1, 31.2,
312/31.3, 31.04, 31.03, 31.01, 31;
D27/186, 187, 189, 190, 191, 193, 194, 110;
D19/75; 24/11 CT; 206/268, 265, 204, 247

2,860,023 11/1958 Herdlitchka 312/31.1
3,382,020 5/1968 Meri 312/31.01

Primary Examiner—Susan J. Lucas
Assistant Examiner—Jennifer Regester
Attorney, Agent, or Firm—Wheat, Camoriano, Smith & Beres PLC

[57] **CLAIM**

The ornamental design for a humidor, as shown and described.

DESCRIPTION

FIG. 1 is a front perspective view of a humidor showing my new design;
FIG. 2 is a right side view of the humidor of FIG. 1; which is a mirror image of the left side view thereof;
FIG. 3 is a front view of the humidor of FIG. 1;
FIG. 4 is a rear view of the humidor of FIG. 1;
FIG. 5 is a top view of the humidor of FIG. 1; and,
FIG. 6 is a bottom view of the humidor of FIG. 1.

[56] **References Cited**
U.S. PATENT DOCUMENTS
1,660,240 2/1928 Sukert 312/31.1
1,676,118 7/1928 Sukert 312/31.1

1 Claim, 1 Drawing Sheet

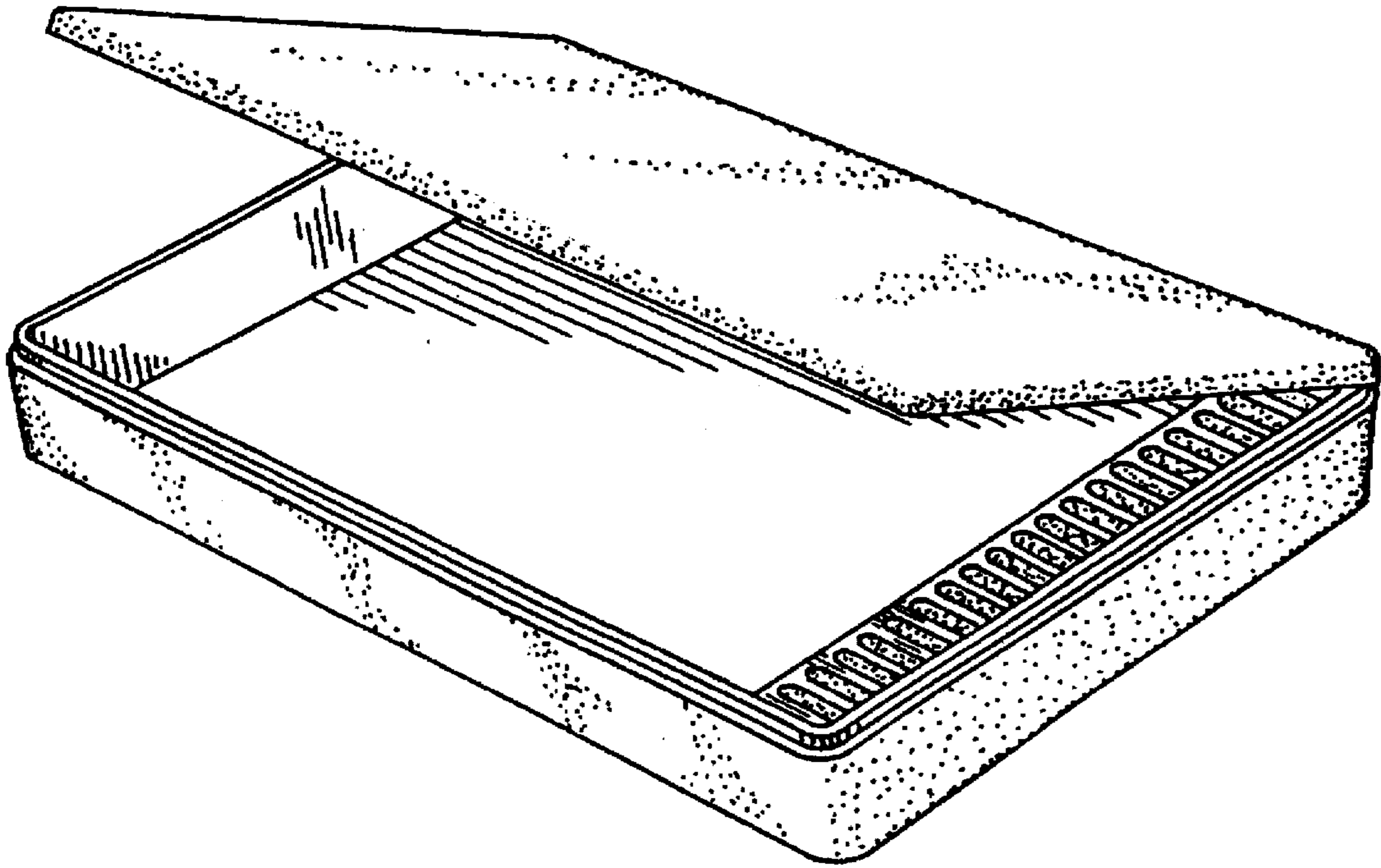

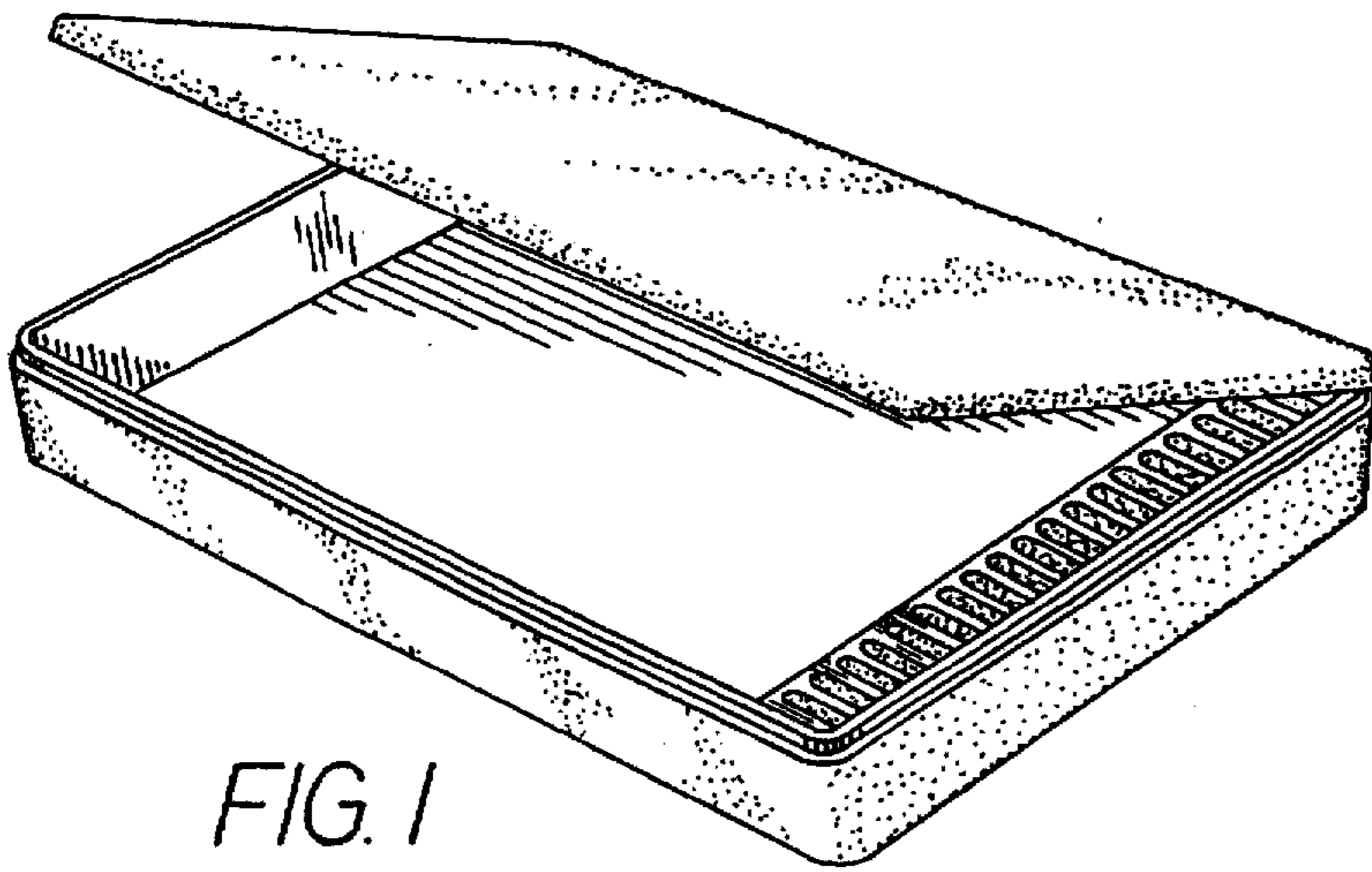

FIG. 1

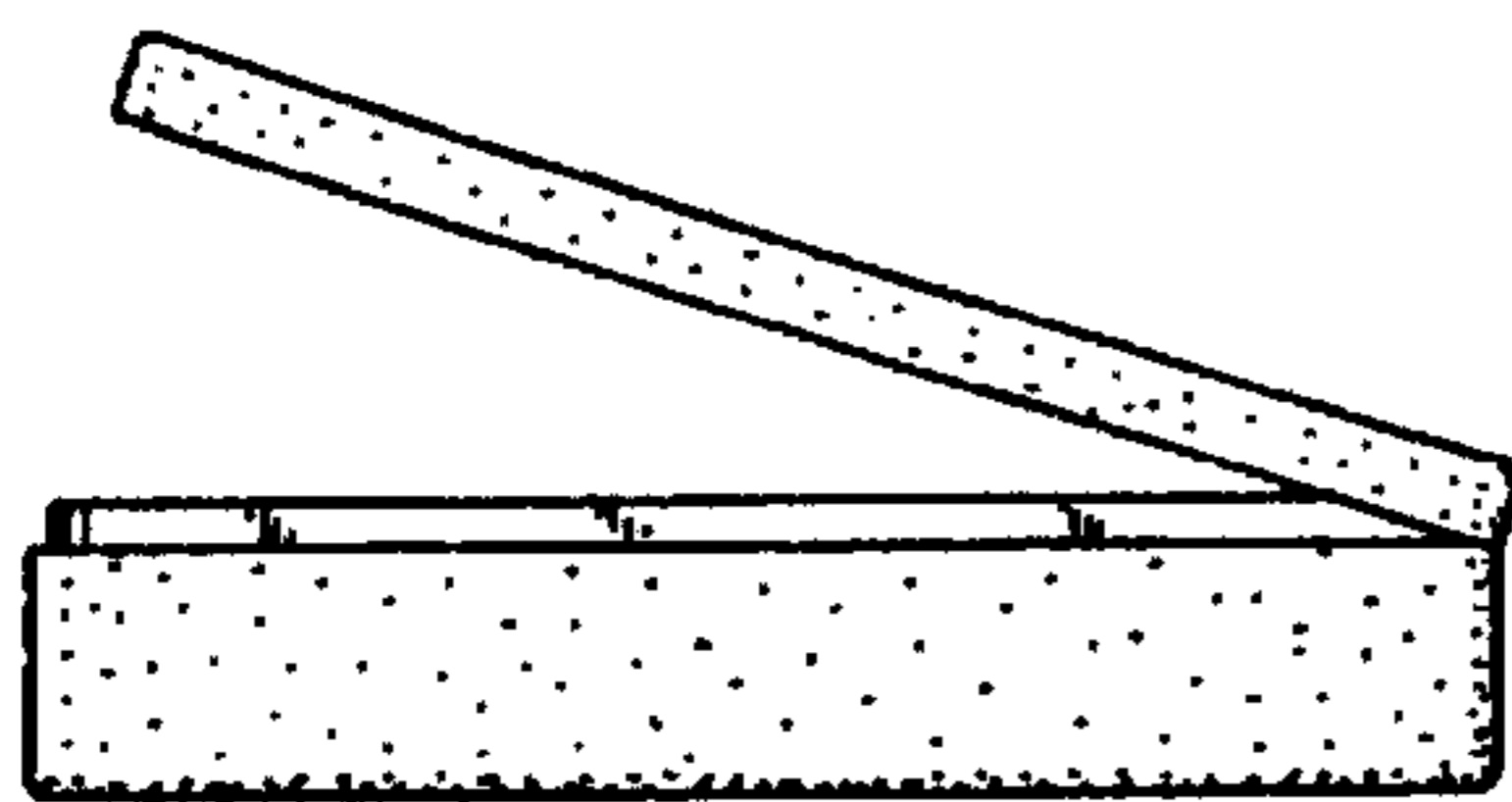

FIG. 2

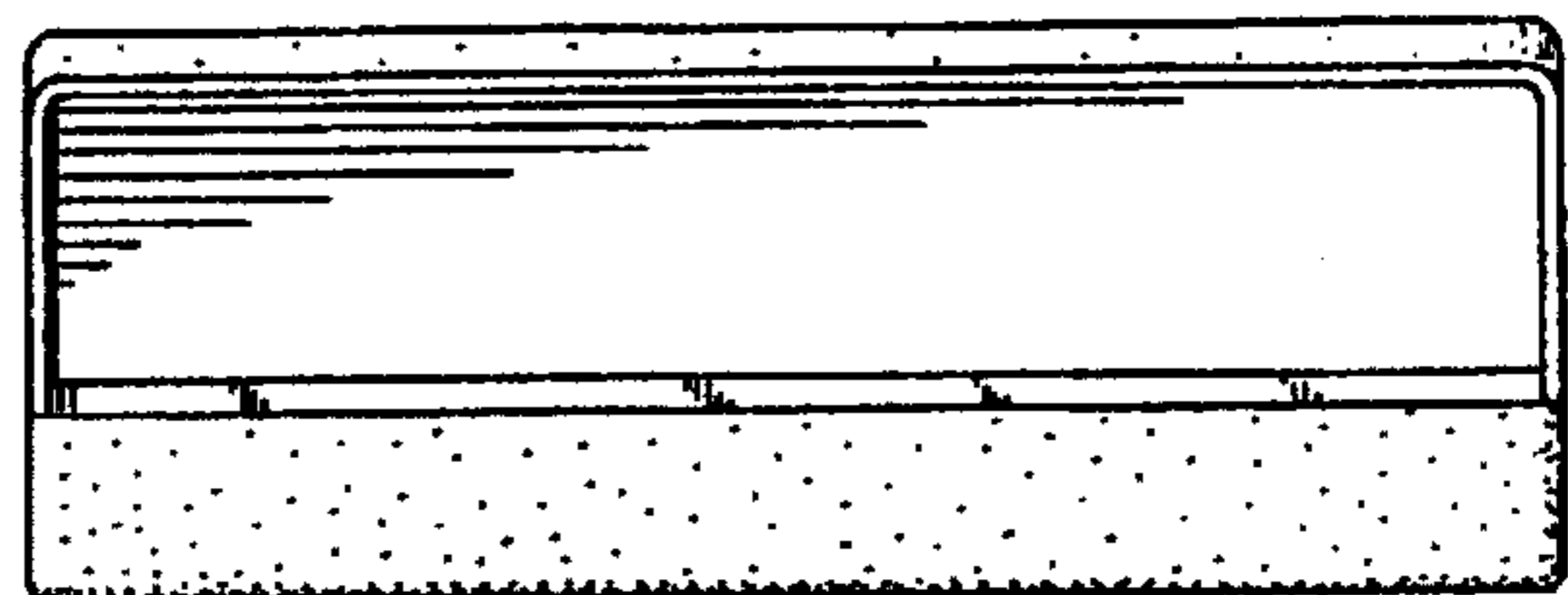

FIG. 3

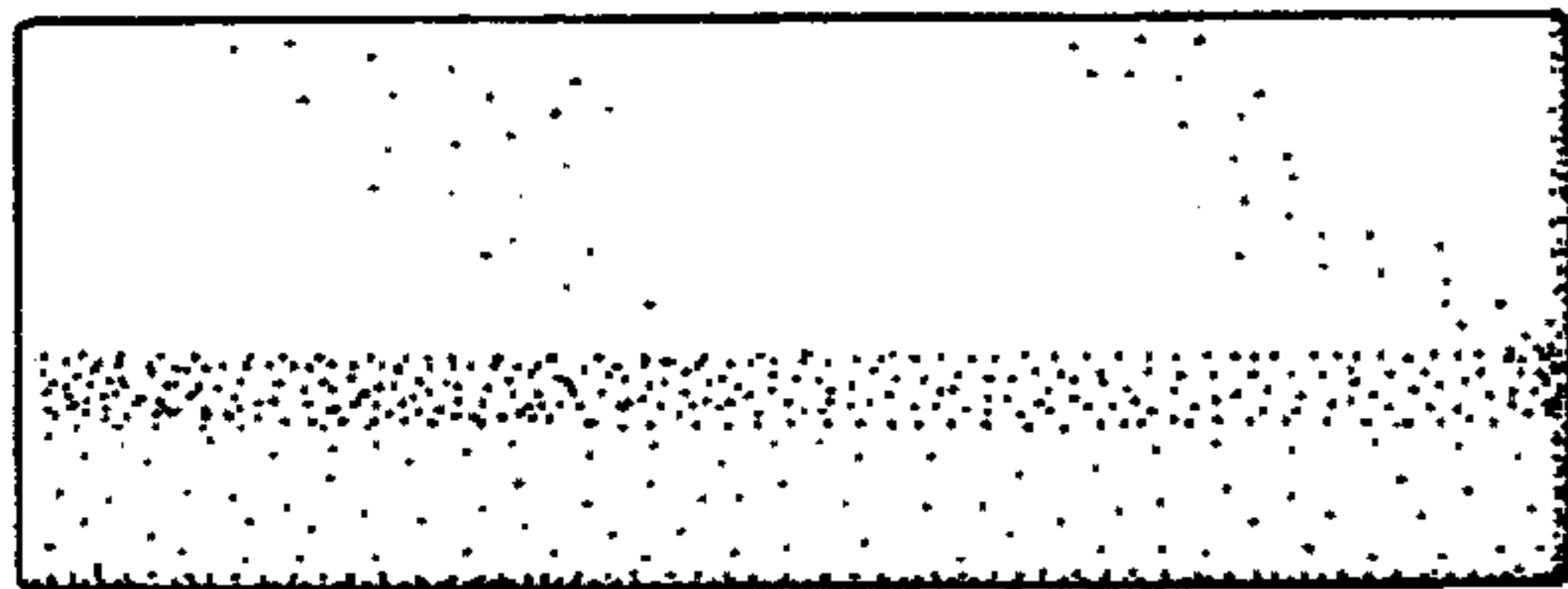

FIG. 4

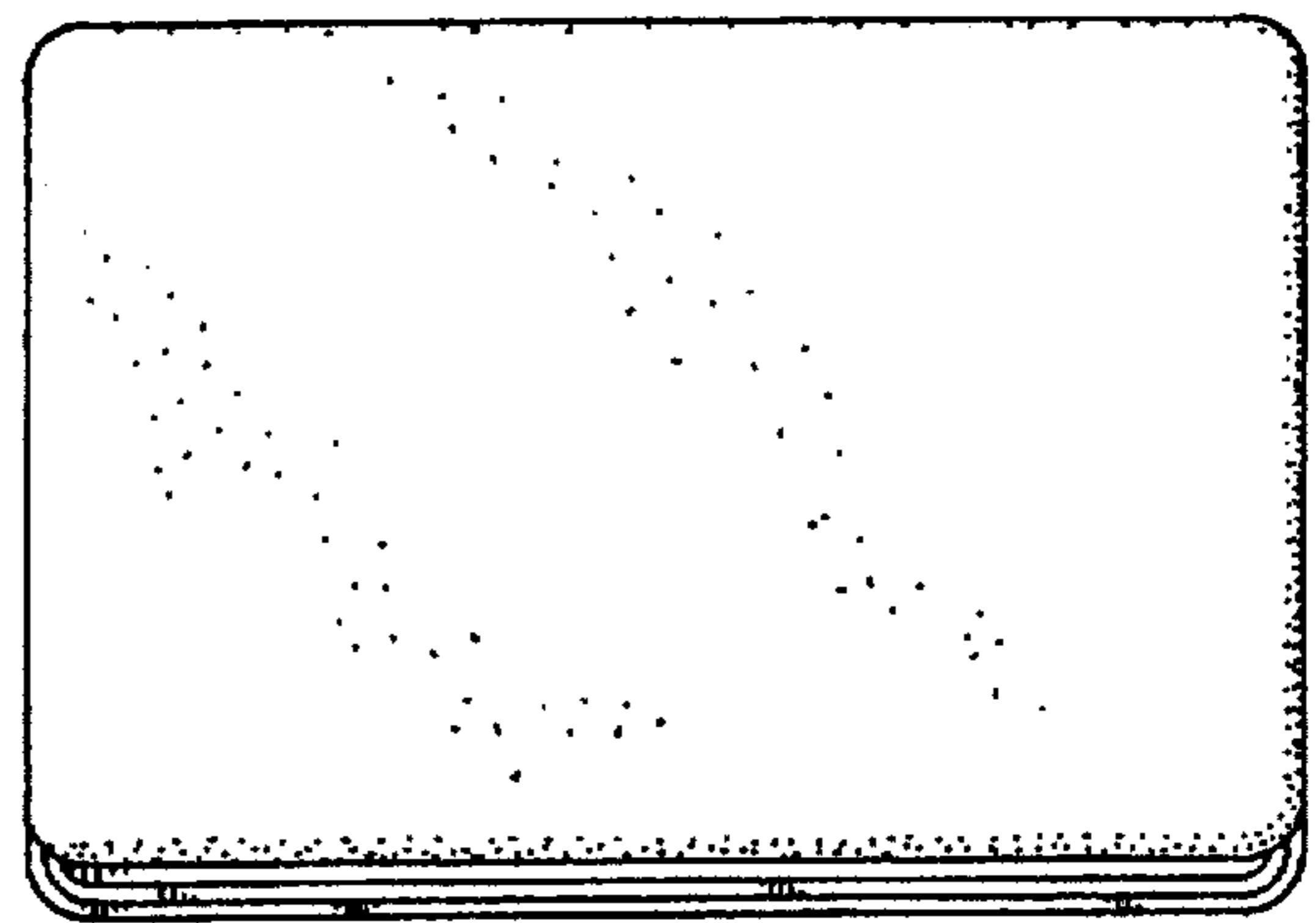

FIG. 5

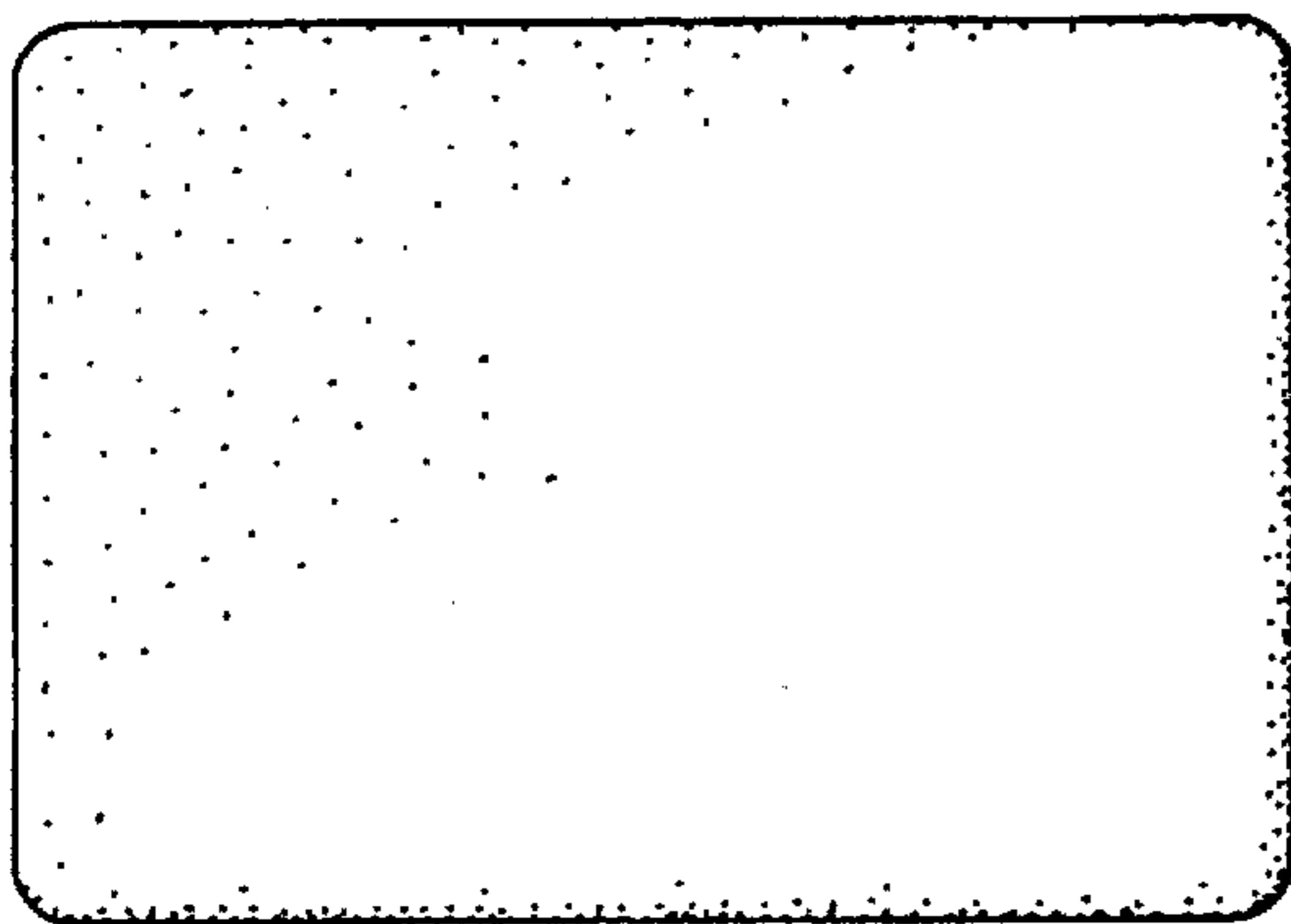

FIG. 6