

US00D385644S

United States Patent [19]
Blackman

[11] **Patent Number: Des. 385,644**

[45] **Date of Patent: **Oct. 28, 1997**

[54] **HANGING LIGHT FIXTURE**

[76] **Inventor: Stephen E. Blackman, 248 Columbia Turnpike, Florham Park, N.J. 07932**

[**] **Term: 14 Years**

[21] **Appl. No.: 33,899**

[22] **Filed: Jan. 23, 1995**

[51] **LOC (6) Cl. 26-05**

[52] **U.S. Cl. D26/84**

[58] **Field of Search D26/72, 80-92, D26/73, 101, 128-136; 362/147, 404-408, 326, 327, 329, 331, 333, 334, 337, 338, 339, 340, 351, 352, 353, 355, 356**

[56] **References Cited**

U.S. PATENT DOCUMENTS

D. 68,017 8/1925 Schaffer D26/84
D. 167,694 9/1952 Irmischer D26/101

OTHER PUBLICATIONS

Kichler Lighting Catalog, ©1989, p. 41, Chandelier #K-1697.

Kichler Lighting Catalog, ©1989, p. 44, Chandelier #K-1959.

New Metal Crafts, Design Collection 1 Catalog, p. 6, Chandelier #1349.

Primary Examiner—Susan J. Lucas
Attorney, Agent, or Firm—Ezra Sutton

[57] **CLAIM**

The ornamental design for a hanging light fixture, as shown and described.

DESCRIPTION

FIG. 1 is a perspective view of a hanging light fixture showing my new design having three lights;

FIG. 2 is a side elevational view thereof, all sides being identical;

FIG. 3 is a top plan view thereof;

FIG. 4 is a bottom plan view thereof;

FIG. 5 is a perspective view of an alternative embodiment having five lights;

FIG. 6 is a side elevational view thereof, all sides being identical;

FIG. 7 is a top plan view thereof;

FIG. 8 is a bottom plan view thereof;

FIG. 9 is a perspective view of a second alternative embodiment having seven lights;

FIG. 10 is a side elevational view thereof, all sides being identical;

FIG. 11 is a top plan view thereof; and,

FIG. 12 is a bottom plan view thereof.

1 Claim, 12 Drawing Sheets

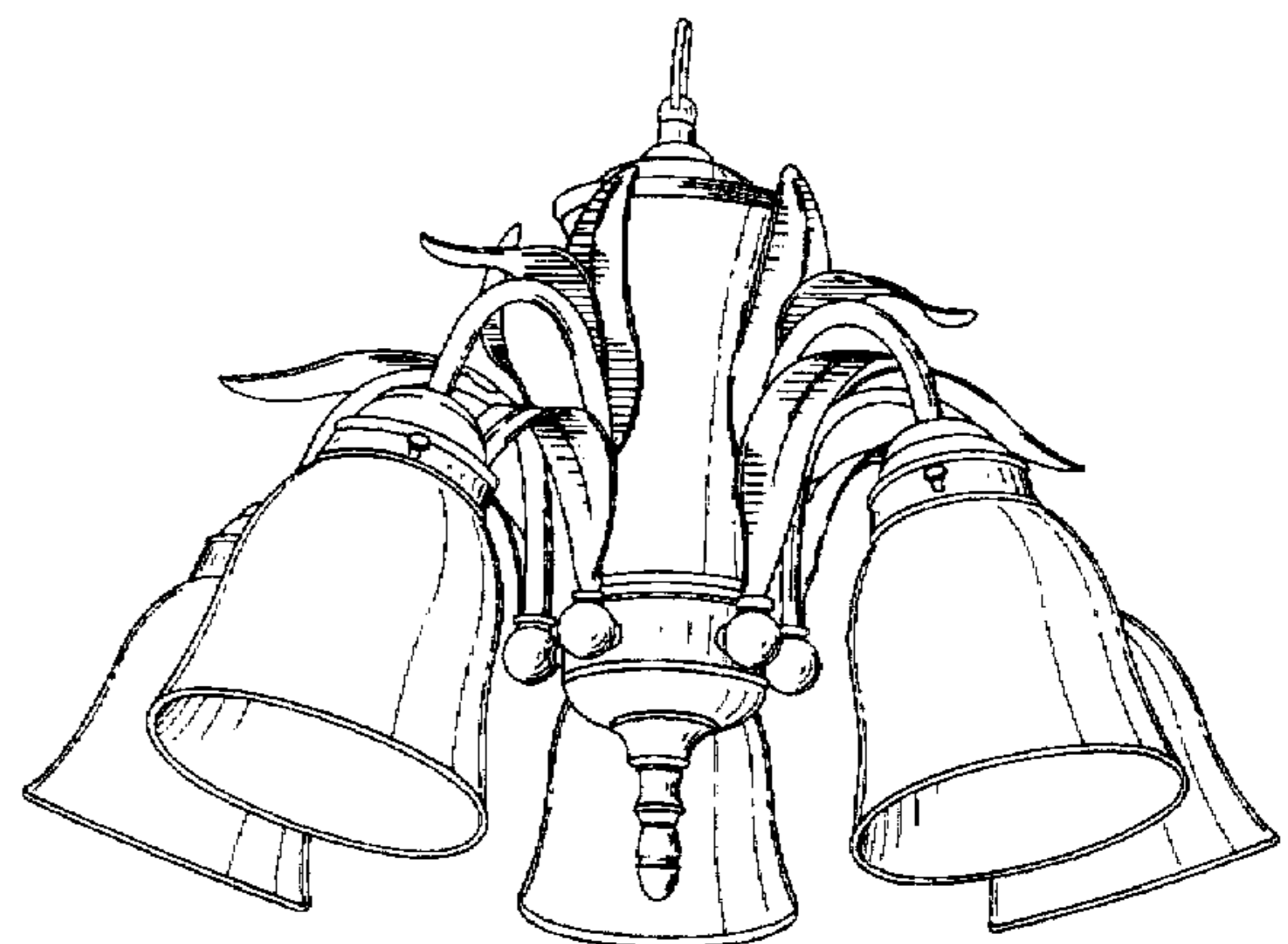
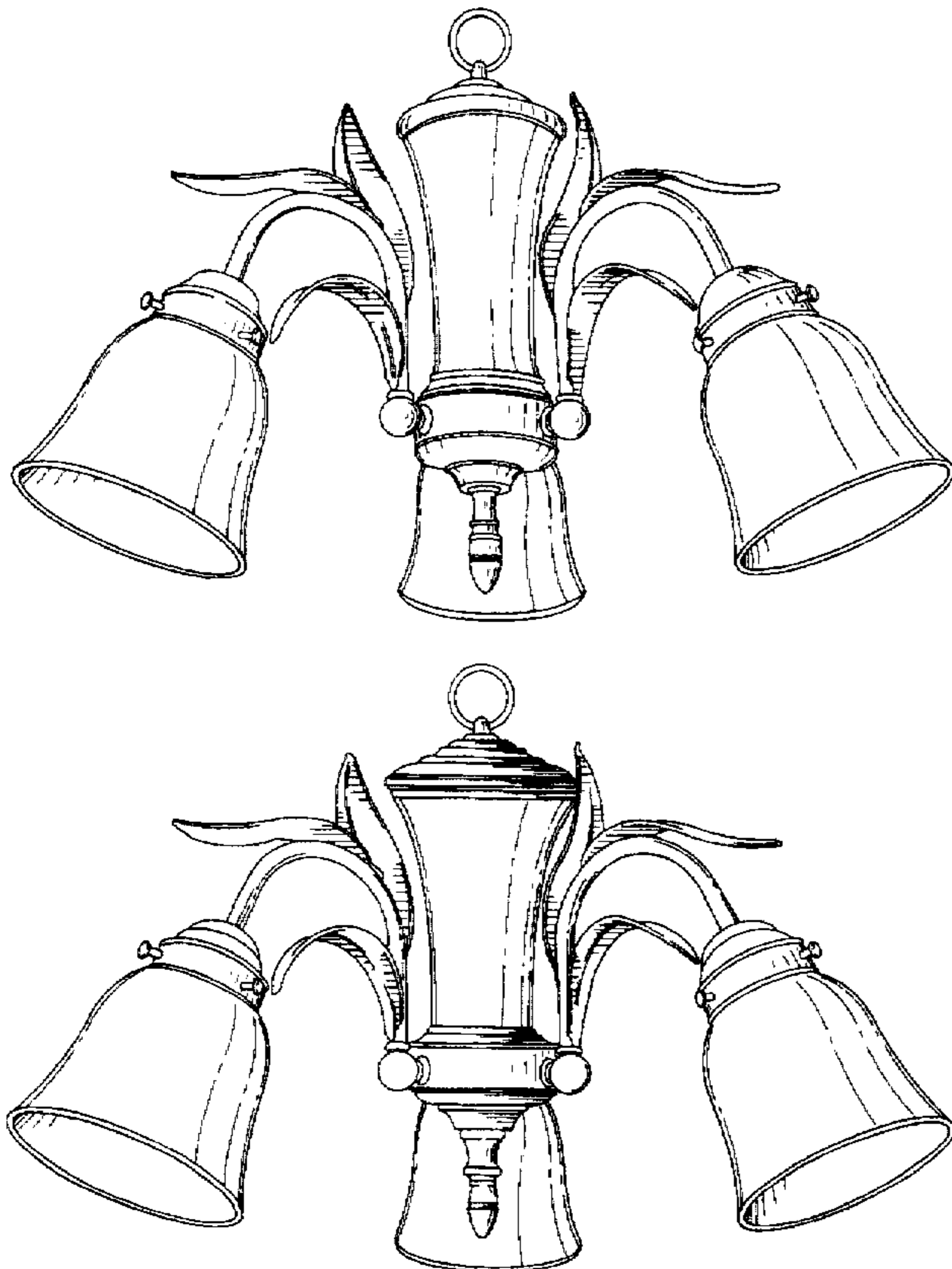

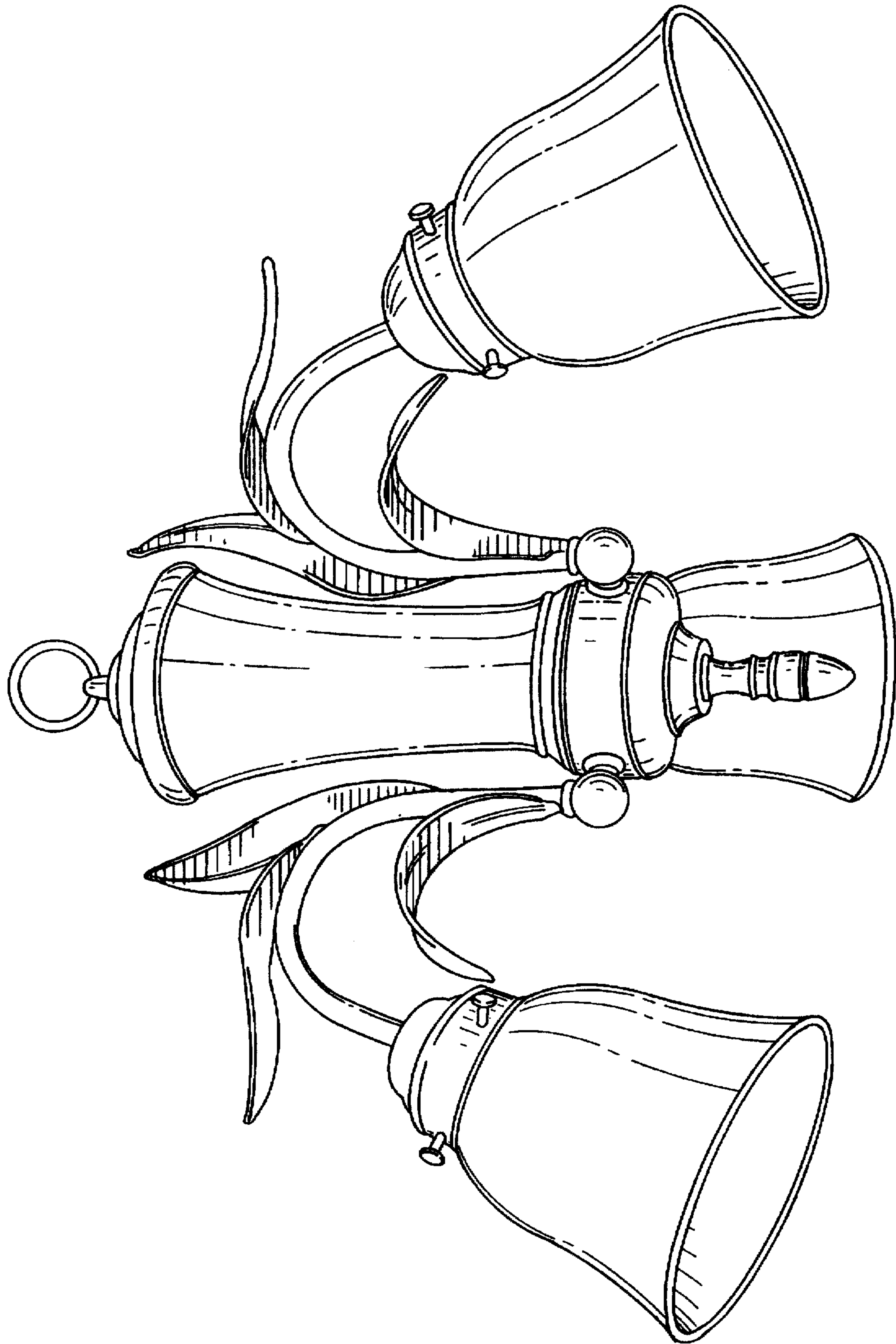

FIG. 1

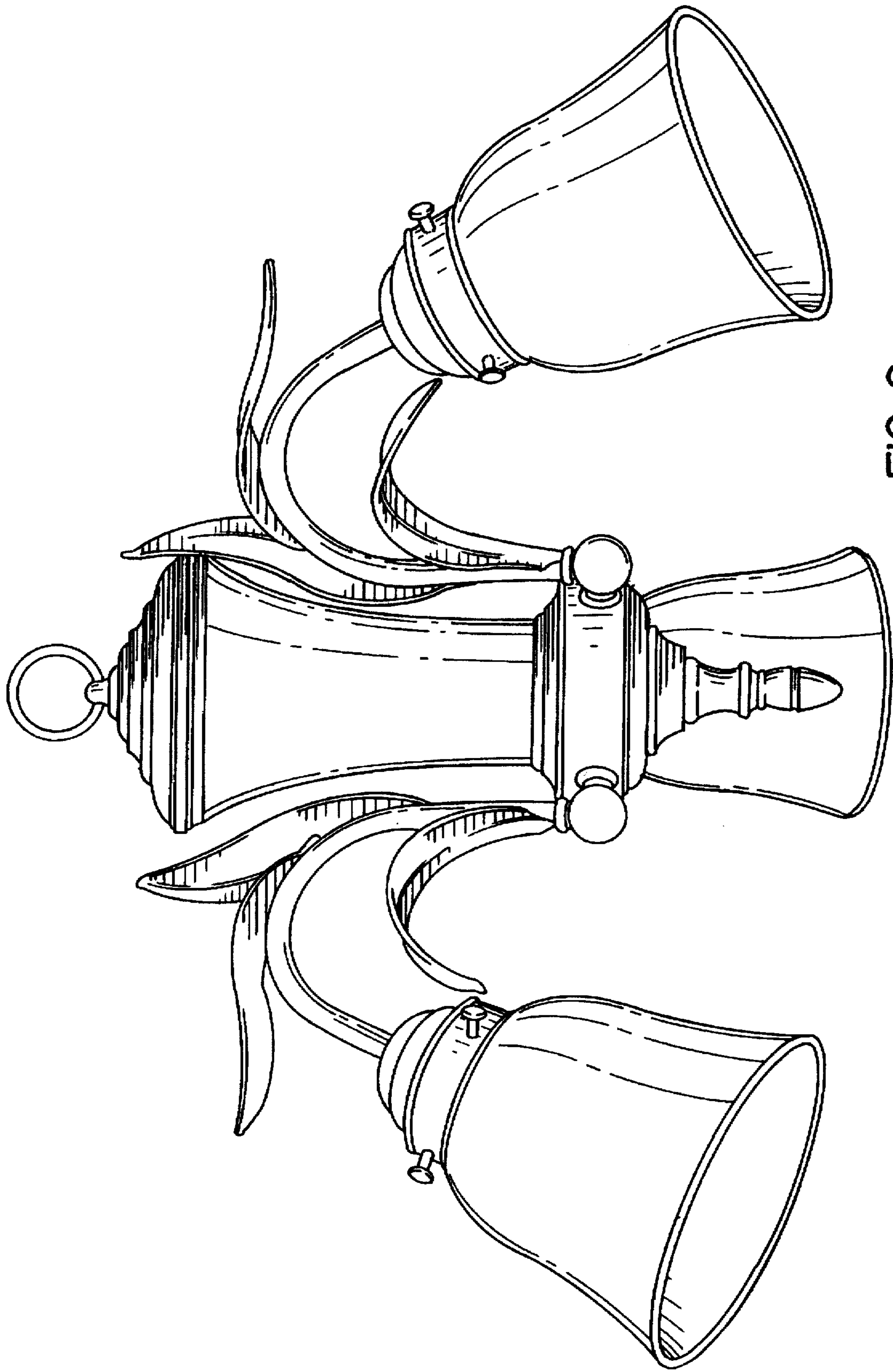

FIG. 2

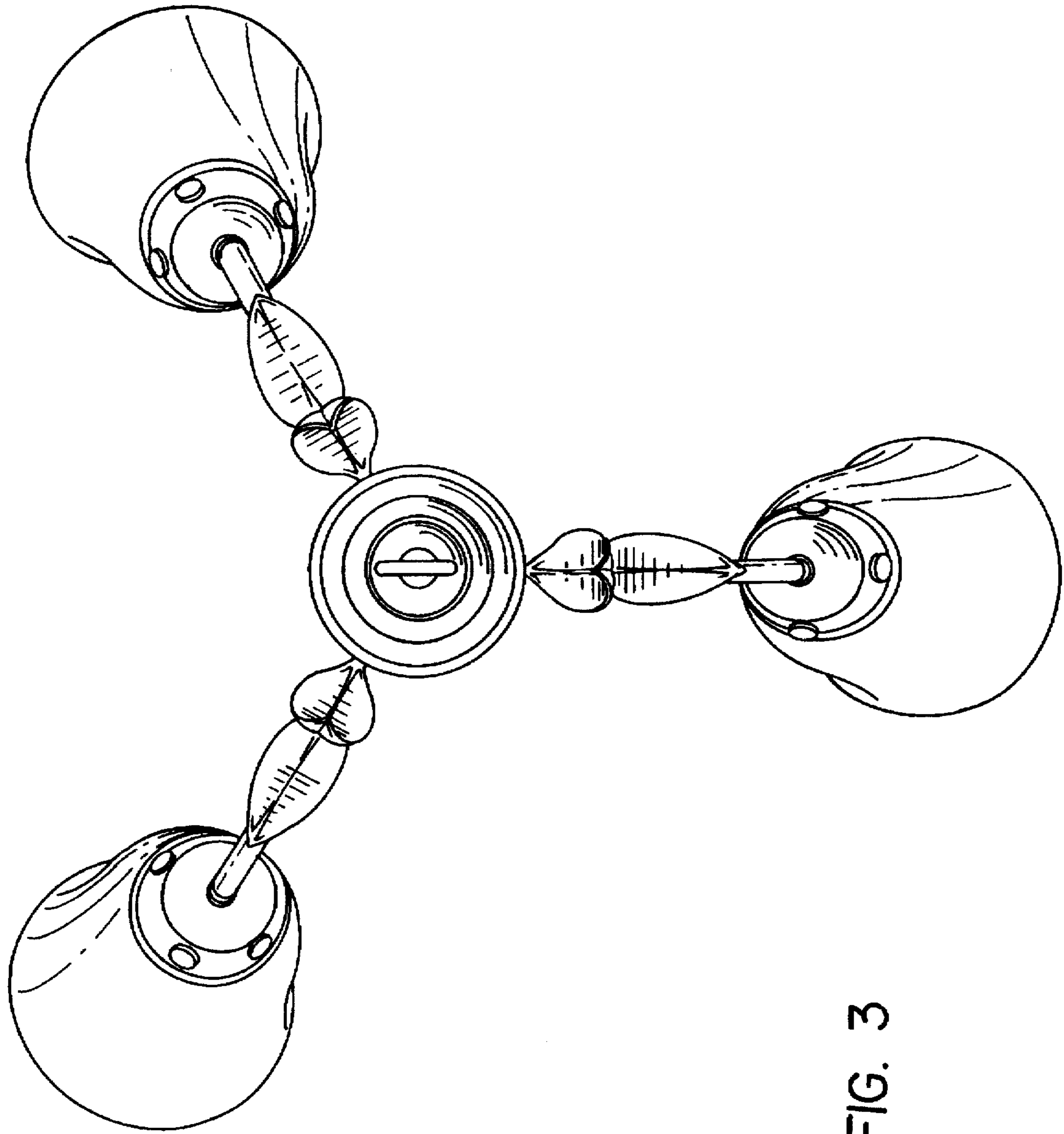

FIG. 3

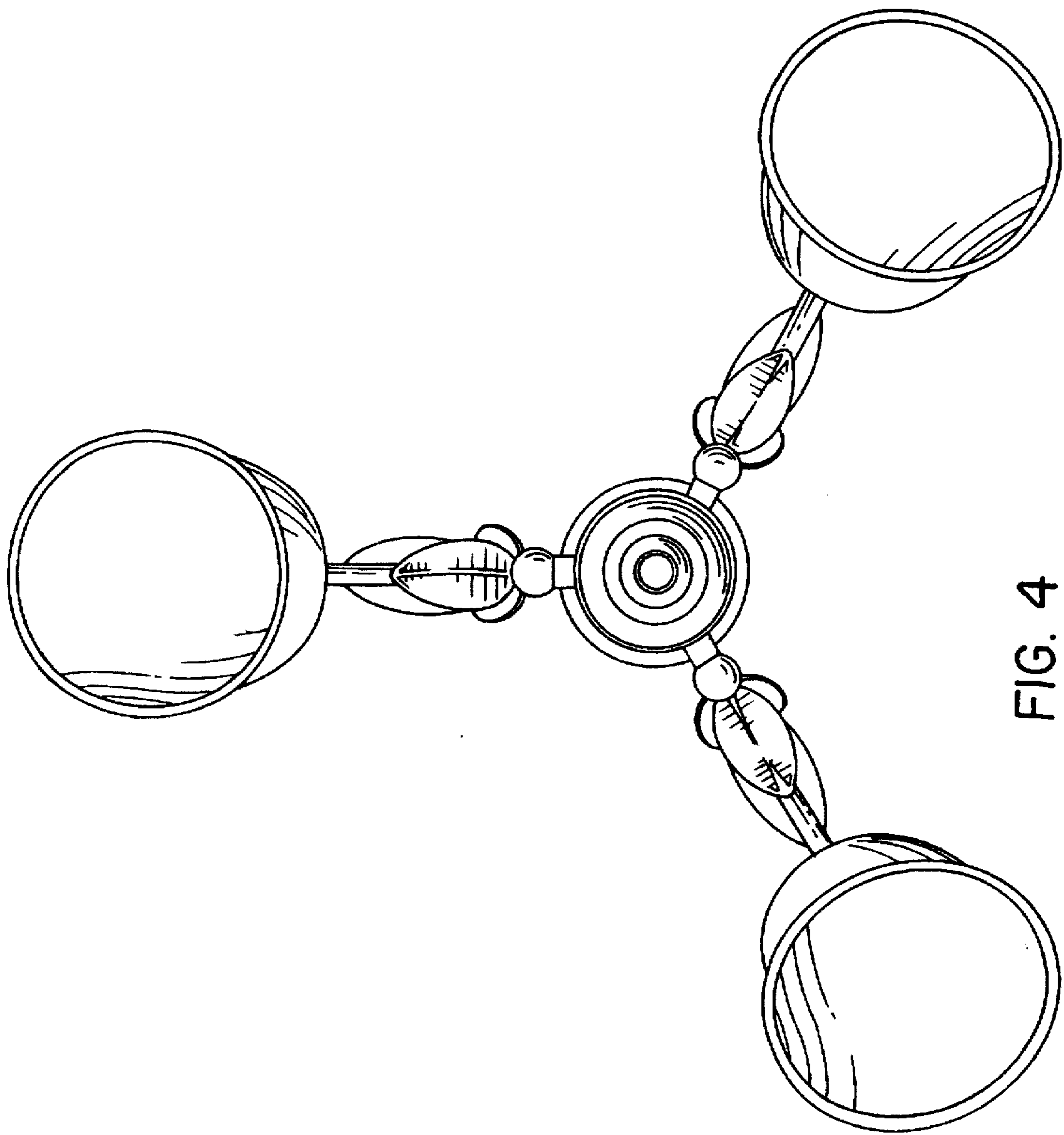

FIG. 4

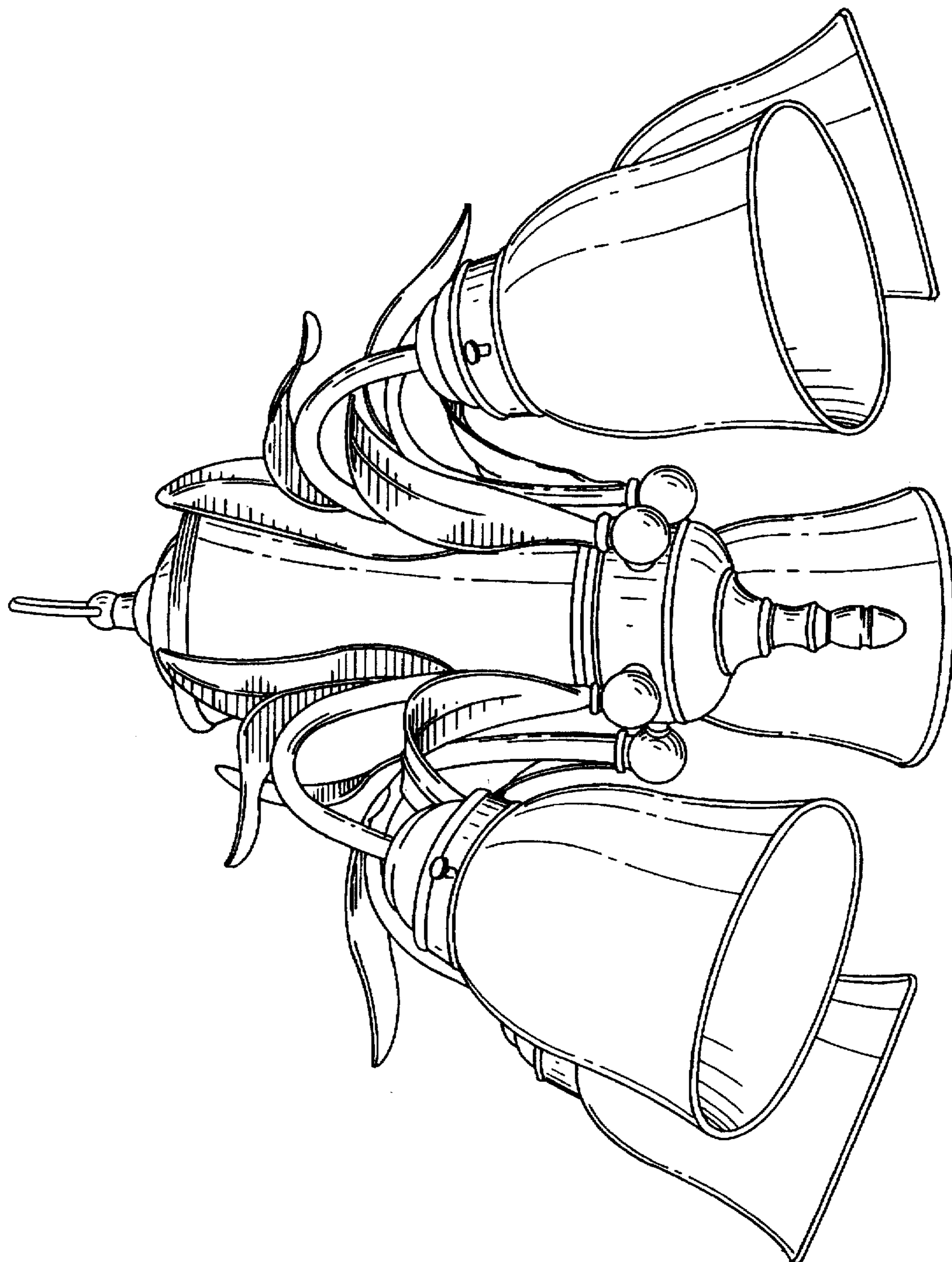

FIG. 5

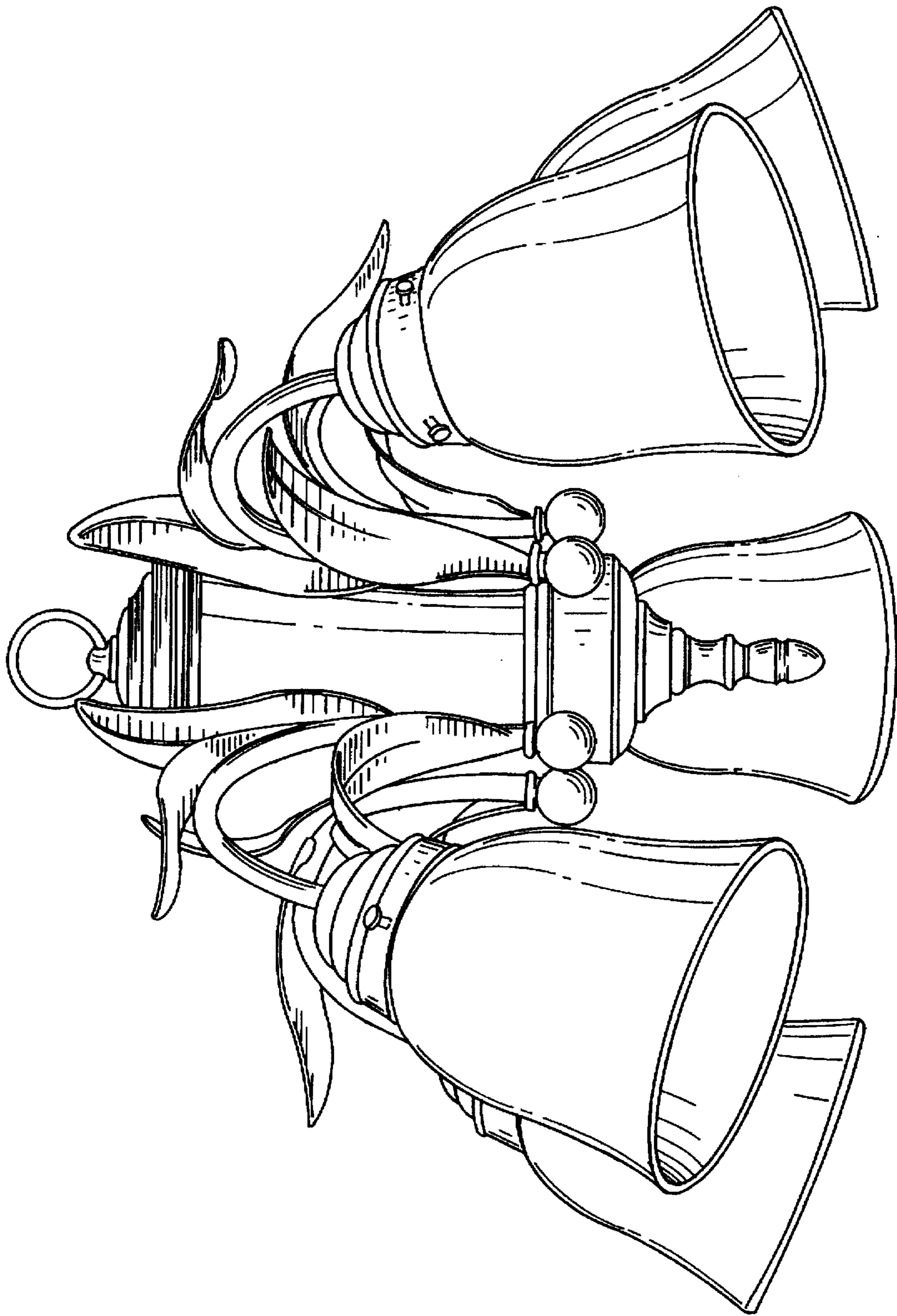

FIG. 6

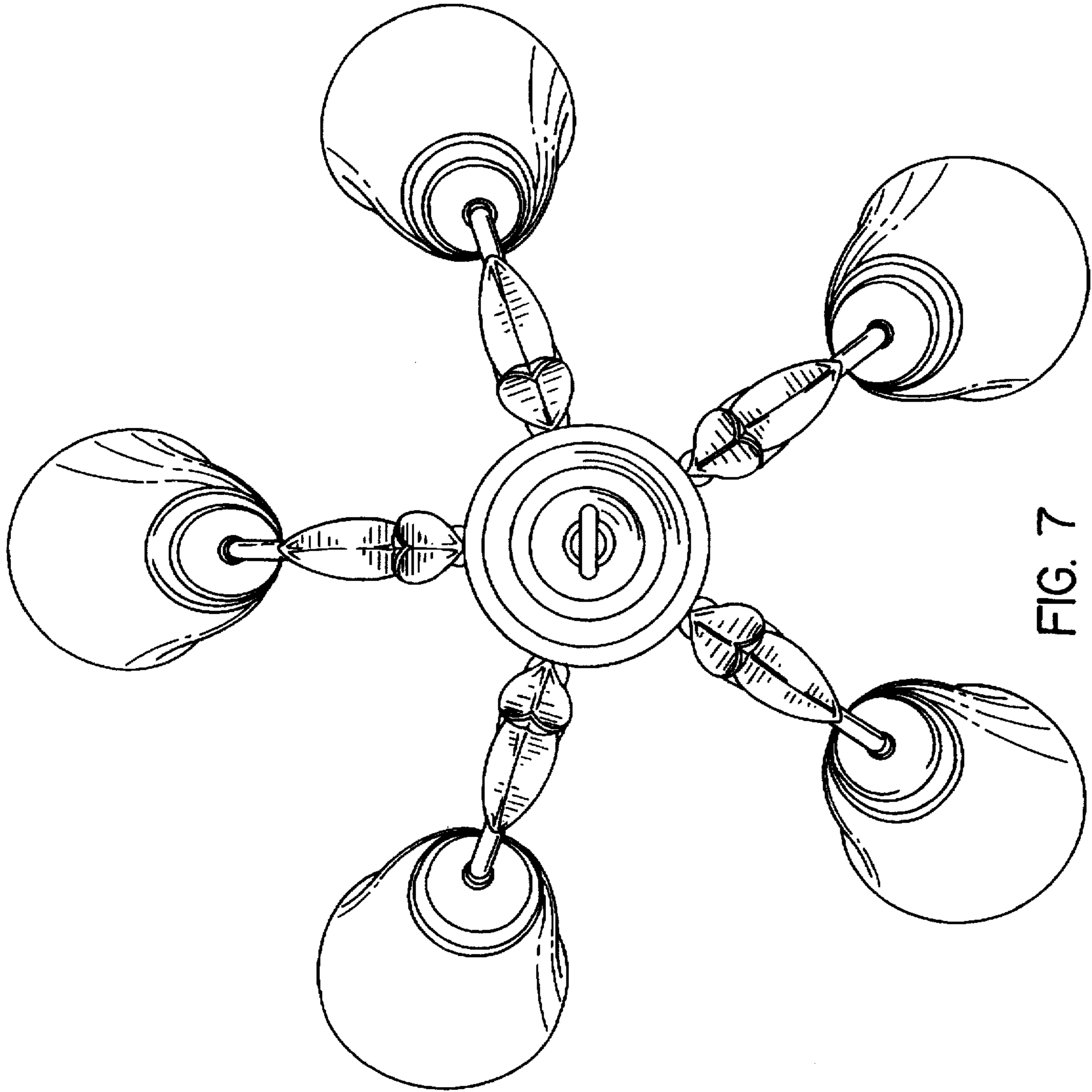

FIG. 7

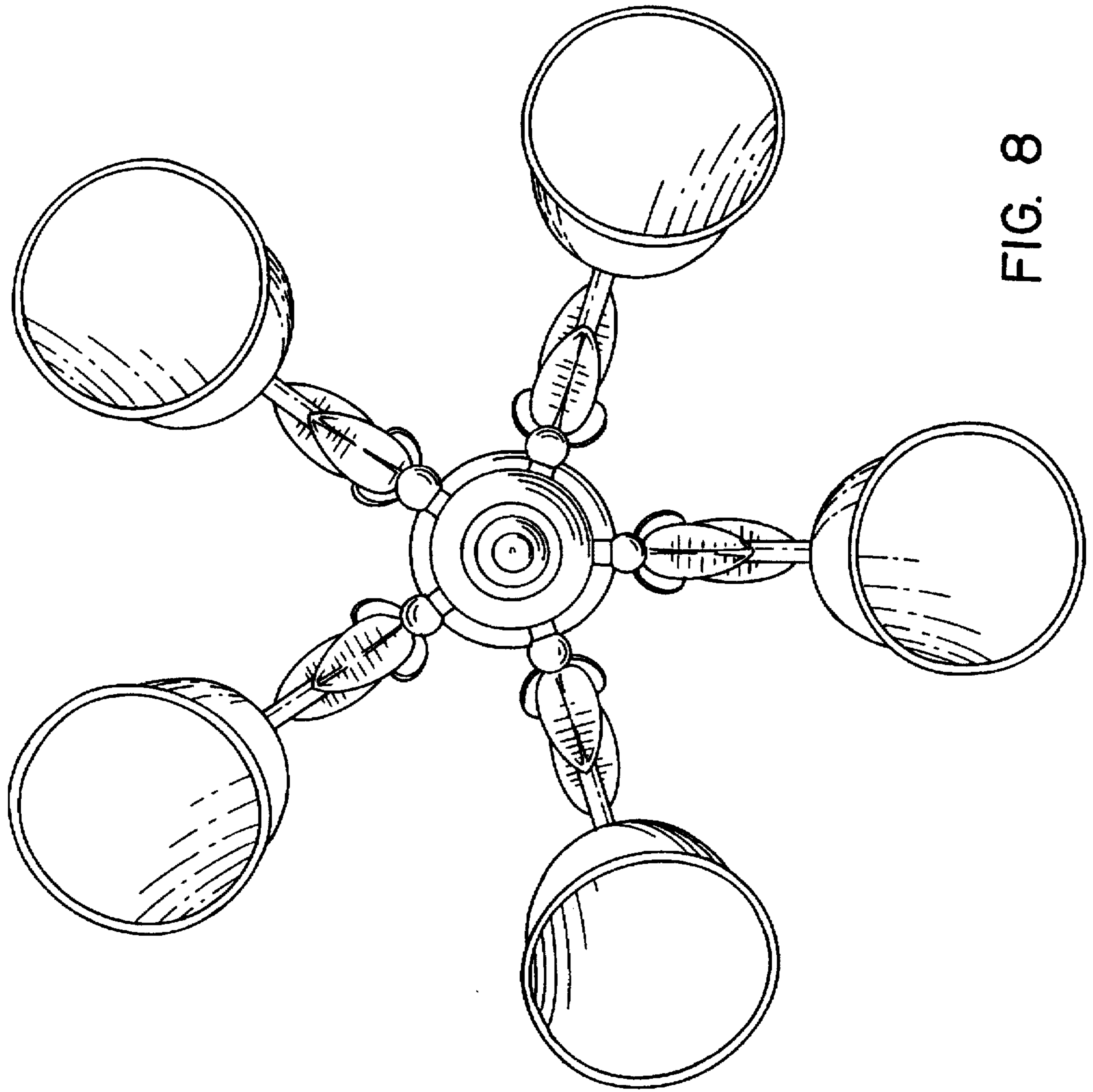

FIG. 8

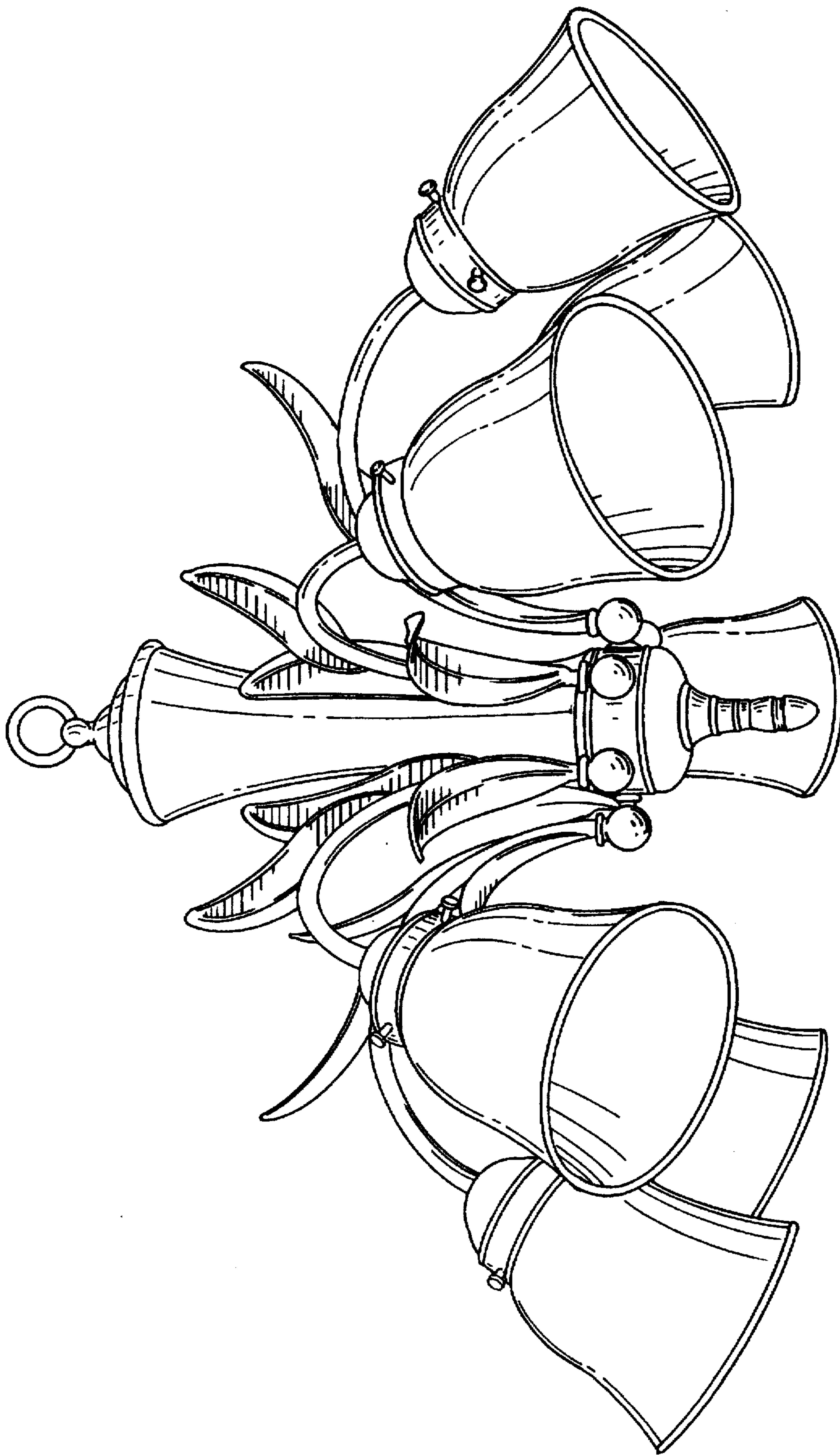

FIG. 9

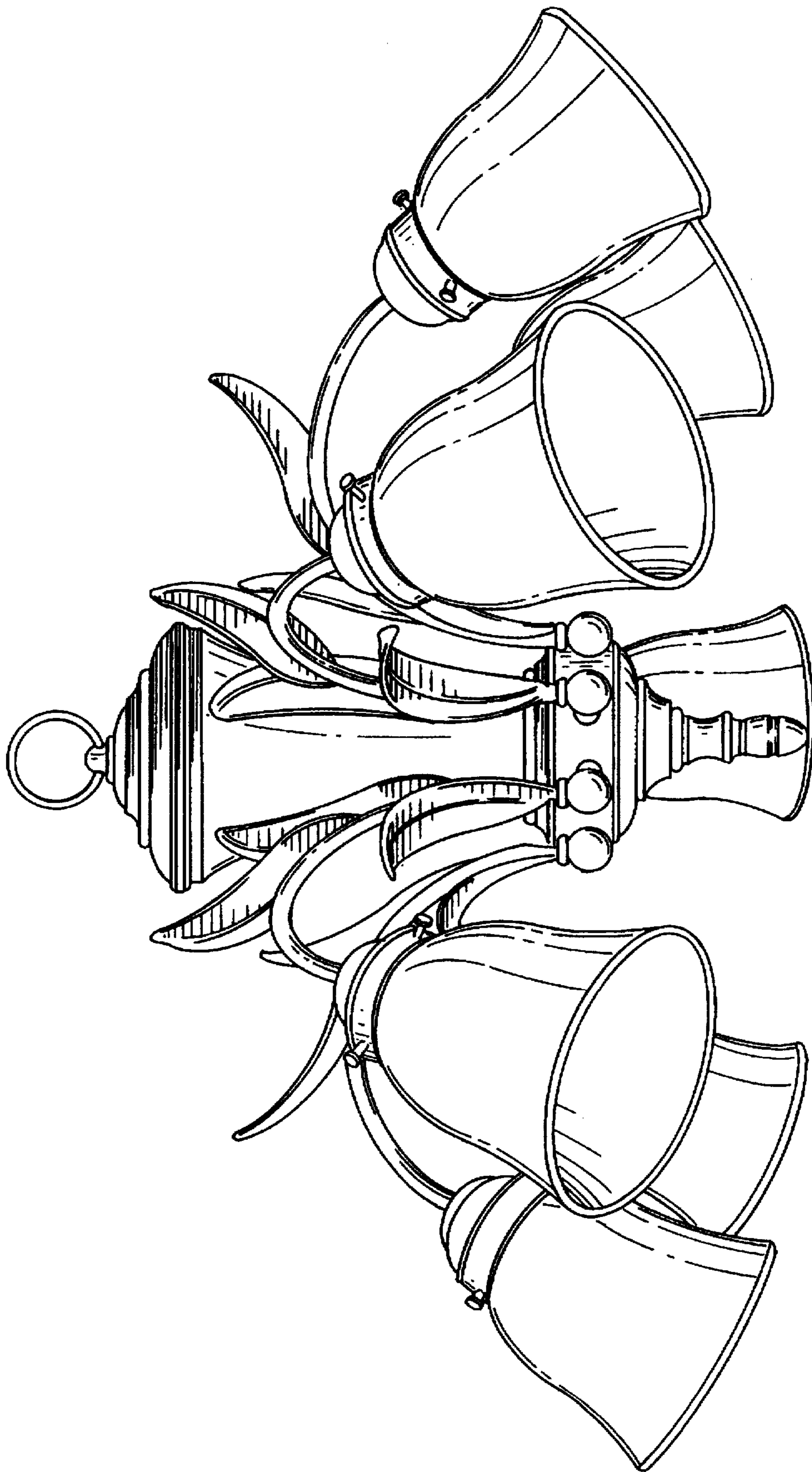

FIG. 10

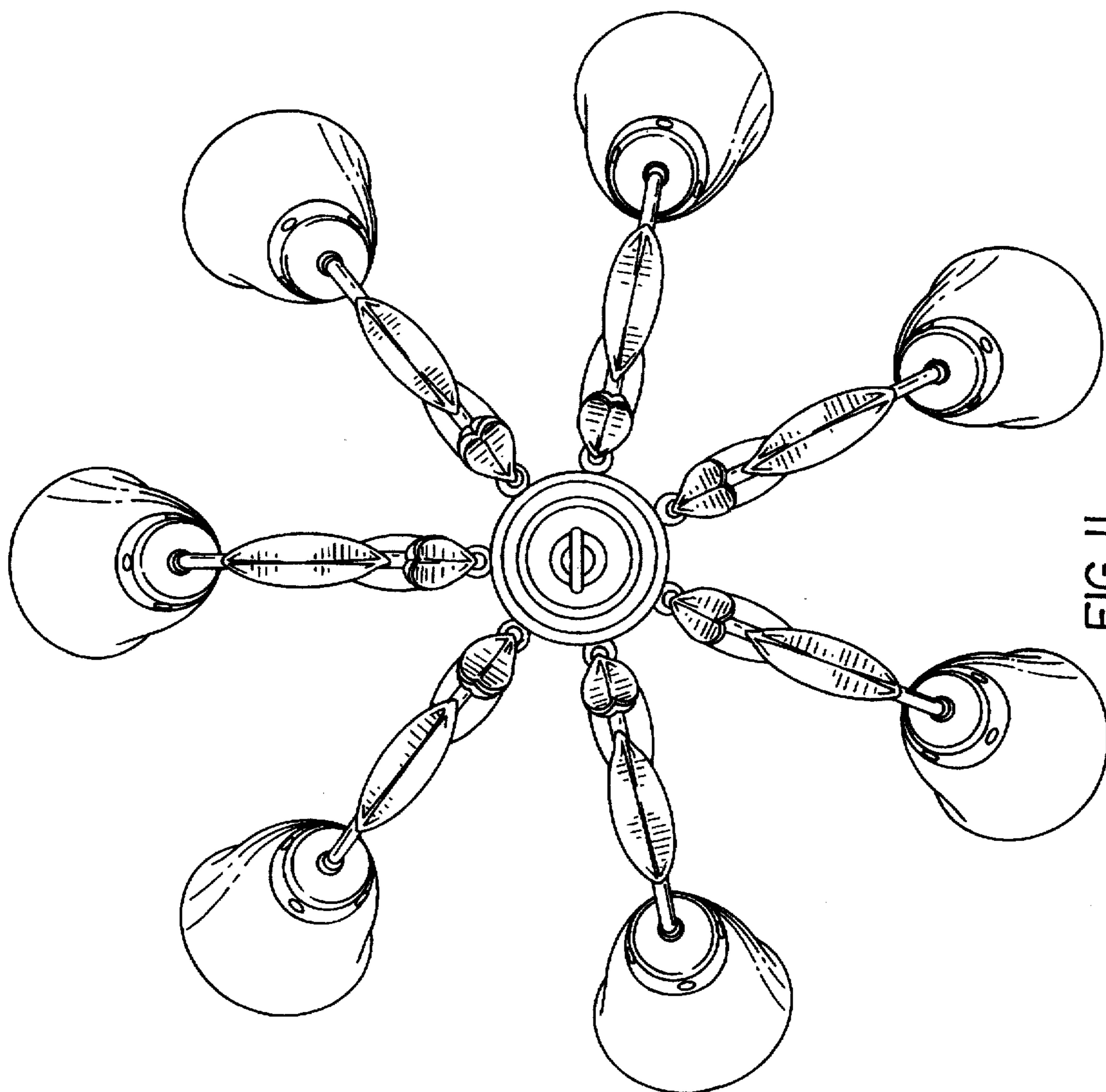

FIG. II

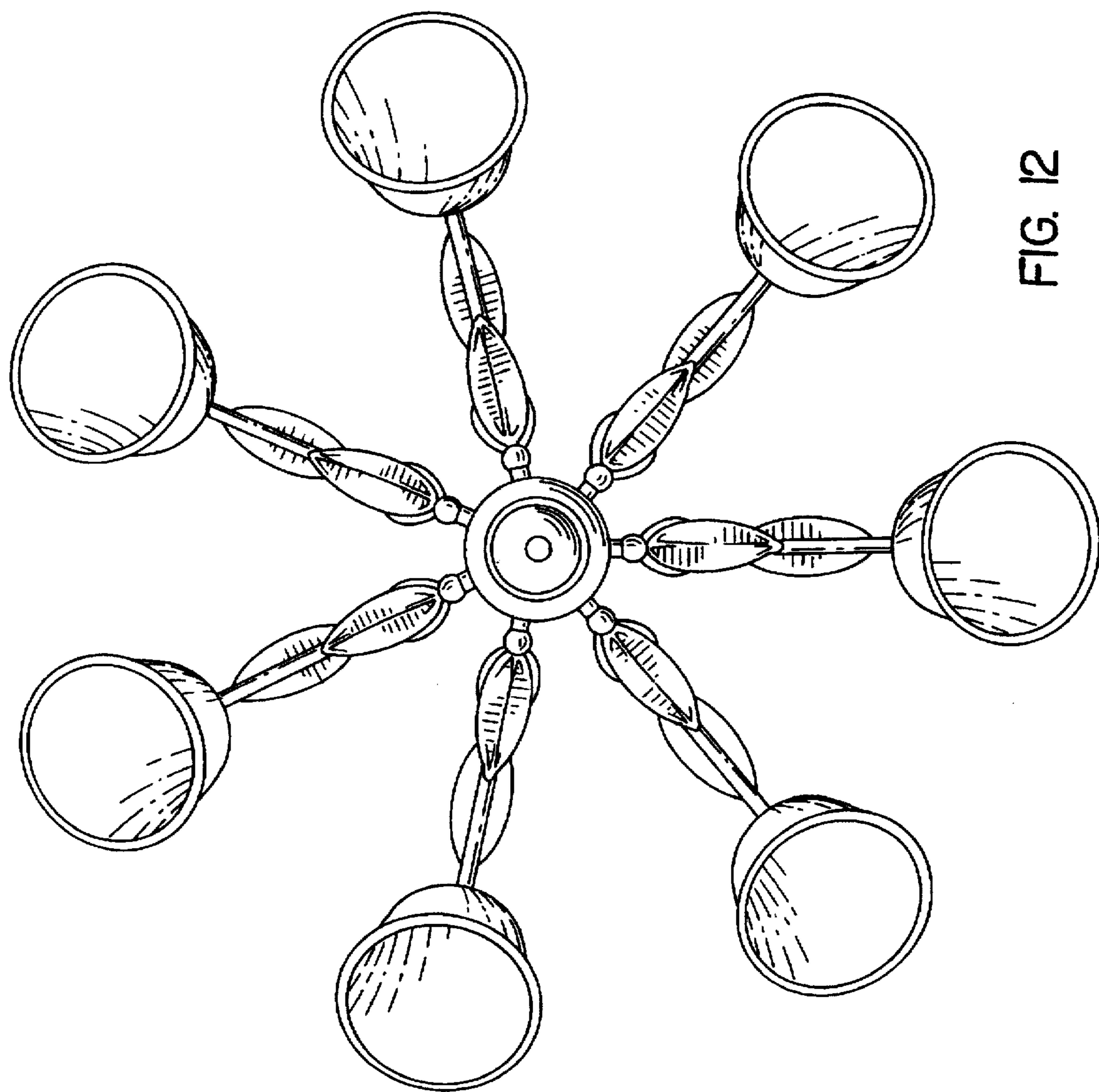

FIG. 12