

US00D385423S

# United States Patent [19] Shields

[11] Patent Number: Des. 385,423

[45] Date of Patent: \*\*Oct. 28, 1997

[54] CHAIR

[75] Inventor: Michael Robert Shields, Greensboro, N.C.

[73] Assignee: Steelcase Inc., Grand Rapids, Mich.

[\*\*] Term: 14 Years

[21] Appl. No.: 51,003

[22] Filed: Mar. 1, 1996

[51] LOC (6) Cl. .... 06-01

[52] U.S. Cl. .... D6/336; D6/338; D6/341

[58] Field of Search ..... D6/334, 335, 336, D6/338, 341, 364, 365, 366, 367, 372, 374, 375, 500, 501, 502; 297/155, 160, 161, 162, 188.08

[56] References Cited

### U.S. PATENT DOCUMENTS

D. 102,971	1/1937	Hale .	
D. 167,595	8/1952	Simmons .	
D. 179,593	1/1957	Cramer .	
D. 192,115	1/1962	Ziegenfuss .	
D. 225,932	1/1973	Duern et al. .	
D. 226,793	5/1973	Watamura et al. .	
D. 246,490	11/1977	DuFresne .....	D6/338
D. 268,550	4/1983	Coggin .	
D. 274,871	7/1984	Matthias .....	D6/372
D. 277,432	2/1985	Appel et al. ....	D6/364
D. 332,703	1/1993	Gulliver .....	D6/338
D. 336,165	6/1993	Tihany .....	D6/334
939,623	11/1909	Payne et al. .	
1,756,210	4/1930	Racz .	
2,671,631	3/1954	Fox .	
2,746,526	5/1956	Loeschmigg et al. .	
3,179,071	4/1965	Johnston .	
3,408,104	10/1968	Raynes .	

3,441,310	4/1969	Gale .
3,572,831	3/1971	Barecki et al. .
3,632,161	1/1972	Arfaras et al. .
4,591,206	5/1986	Pribble .
5,169,210	12/1992	Fricano .
5,380,064	1/1995	Yamano et al. .

Primary Examiner—Gary D. Watson  
Attorney, Agent, or Firm—Price, Heneveld, Cooper, DeWitt & Litton

### [57] CLAIM

The ornamental design for a chair, as shown and described.

### DESCRIPTION

FIG. 1 is a front perspective view of a chair, showing our new design;  
 FIG. 2 is a left side elevational view thereof, the right side elevational view being a mirror image thereof;  
 FIG. 3 is a front elevational view thereof;  
 FIG. 4 is a top view thereof; and  
 FIG. 6 is a front perspective view of still another chair, showing our new design, including a table shown in a storage position;  
 FIG. 7 is a left side elevational view thereof;  
 FIG. 8 is a front elevational view thereof;  
 FIG. 9 is a top view thereof;  
 FIG. 10 is a rear elevational thereof;  
 FIG. 11 is a right side elevational view thereof; and  
 FIG. 12 is a front perspective view of the chair design shown in FIG. 13, the table being shown in a use position;  
 FIG. 13 is a left side elevational view thereof, the right side elevational new being substantially a mirror image thereof;  
 FIG. 14 is a front elevational view thereof;  
 FIG. 15 is a top view thereof; and  
 FIG. 16 is a rear elevational view thereof.  
 The broken lines shown in all views represent stitching.

1 Claim, 9 Drawing Sheets



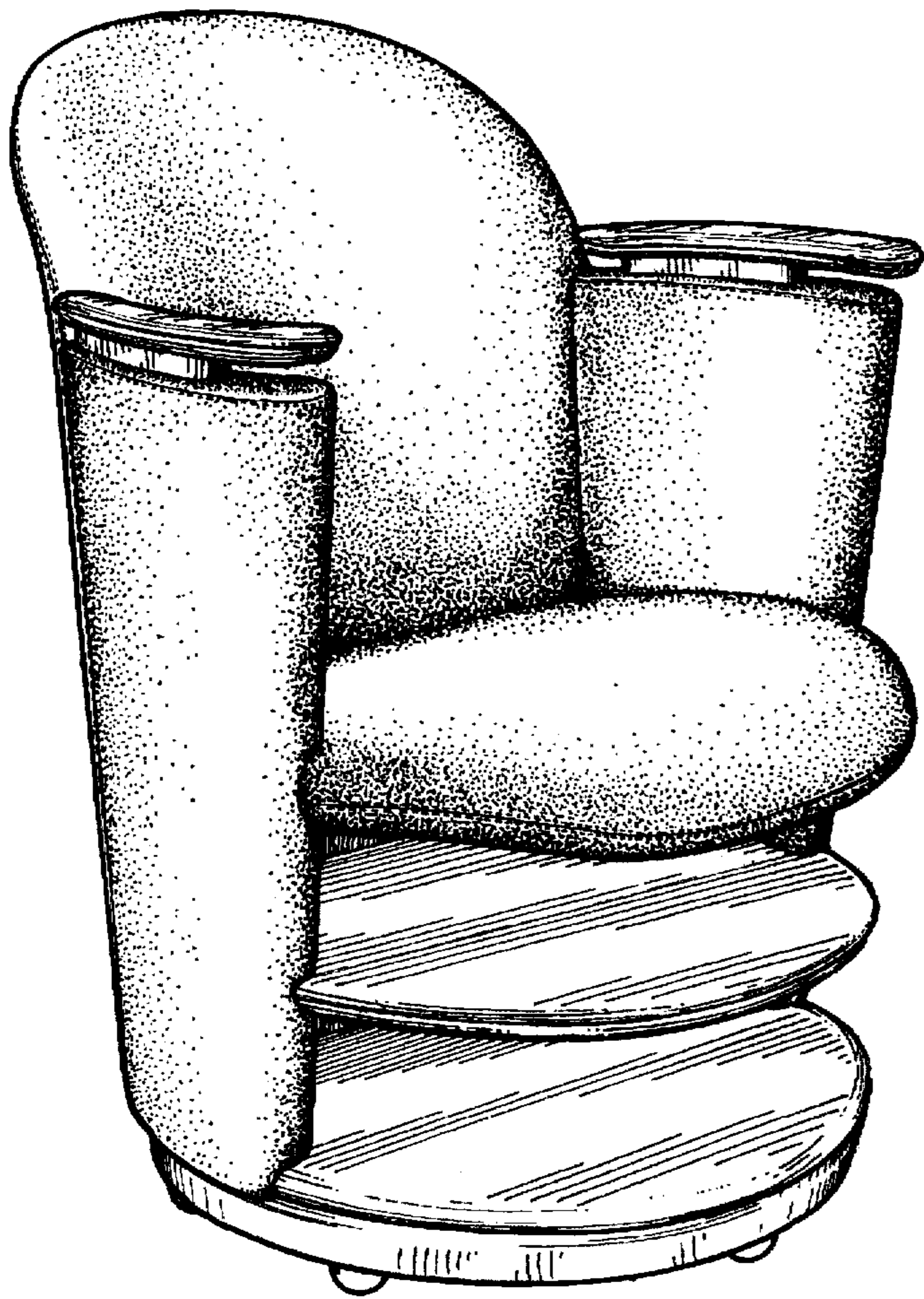

Fig. 1

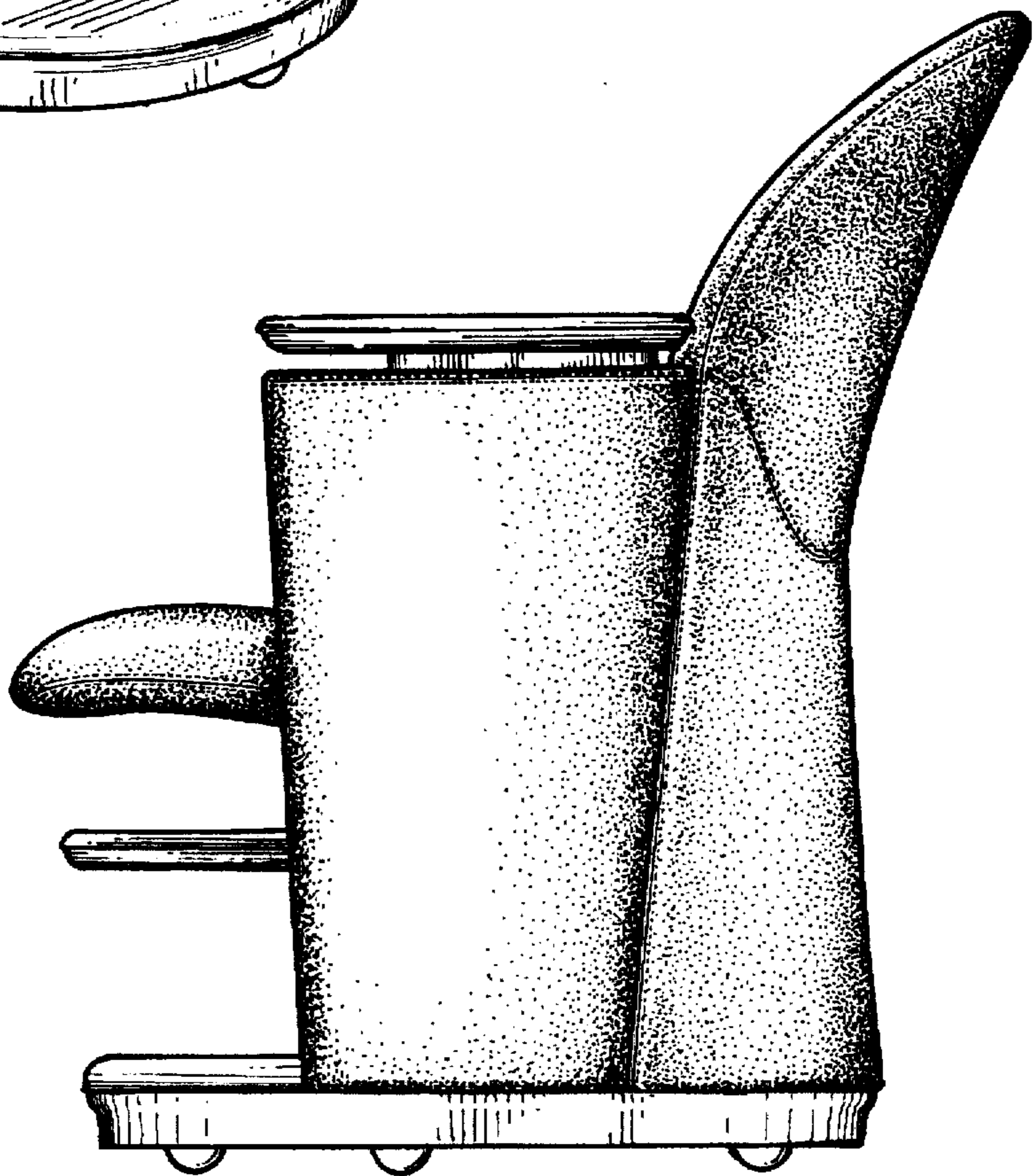

Fig. 2

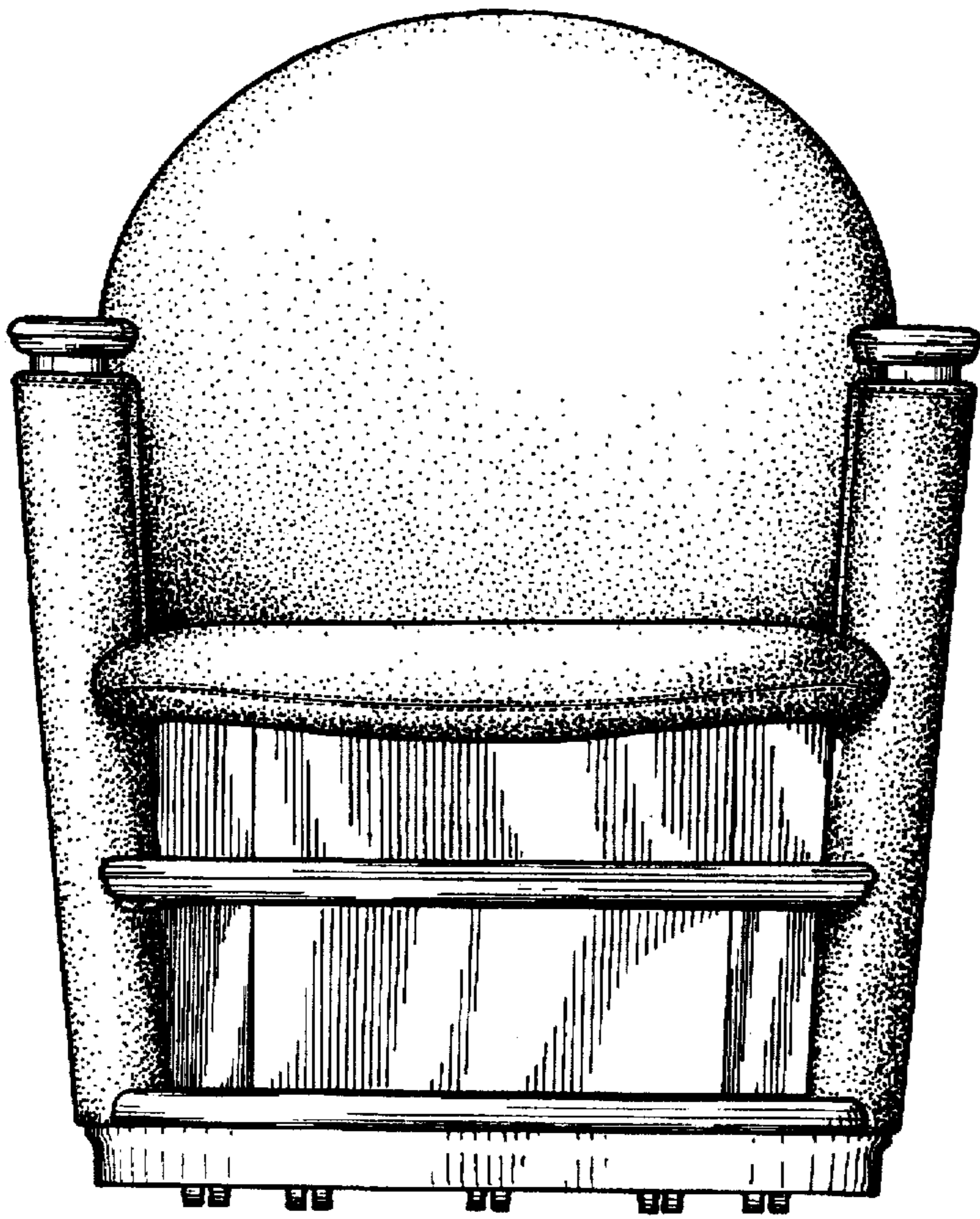

Fig. 3

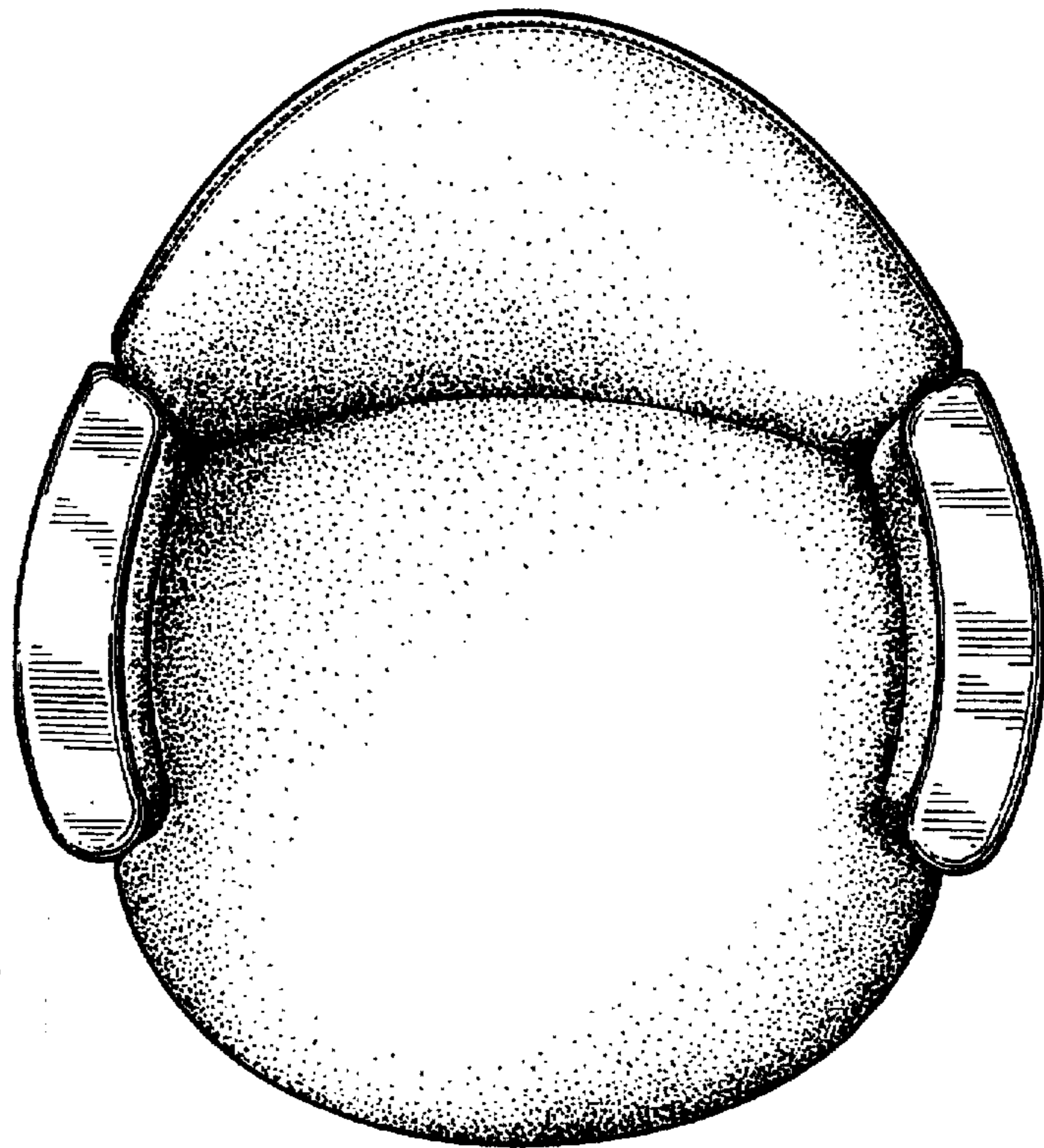

Fig. 4

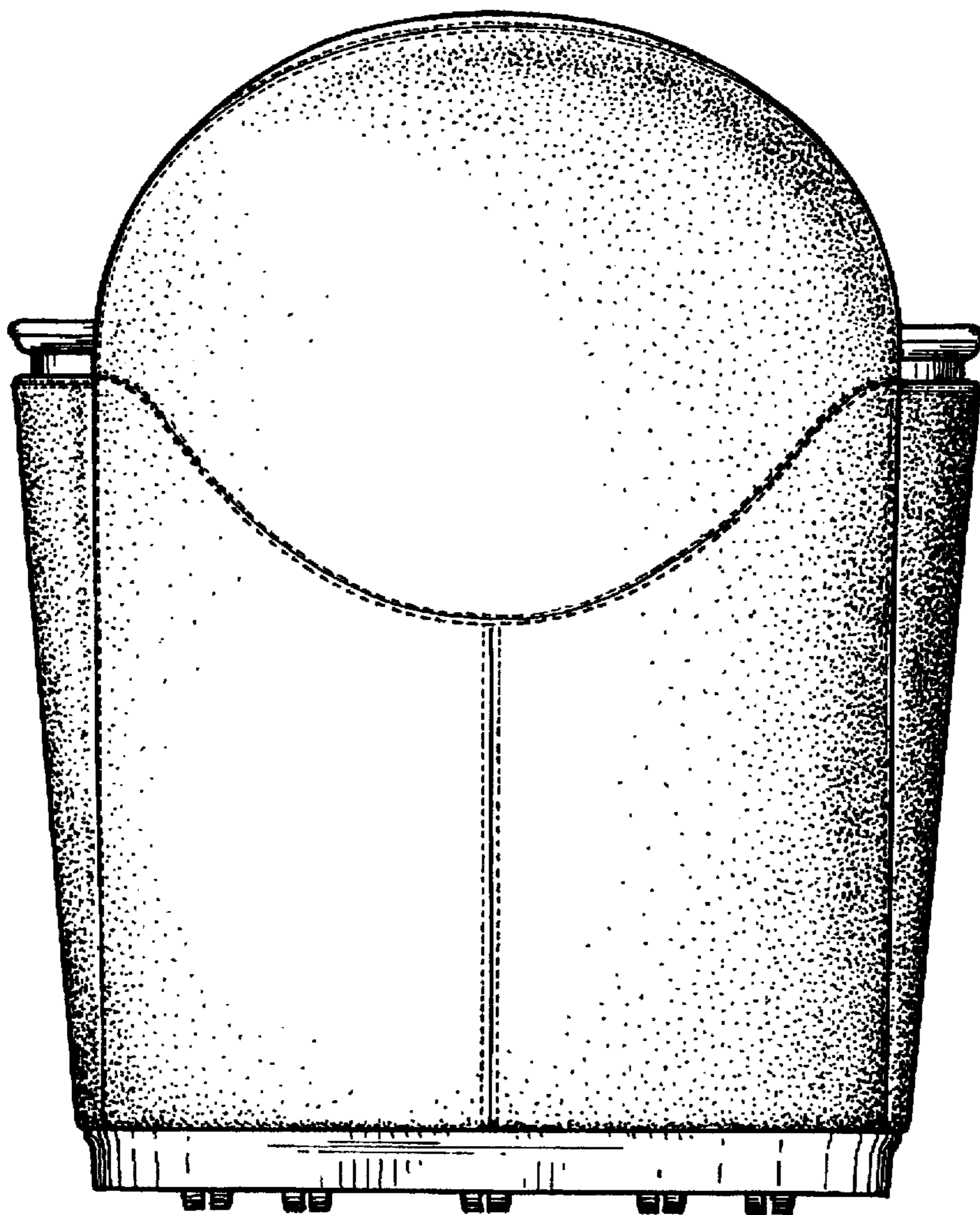

Fig. 5

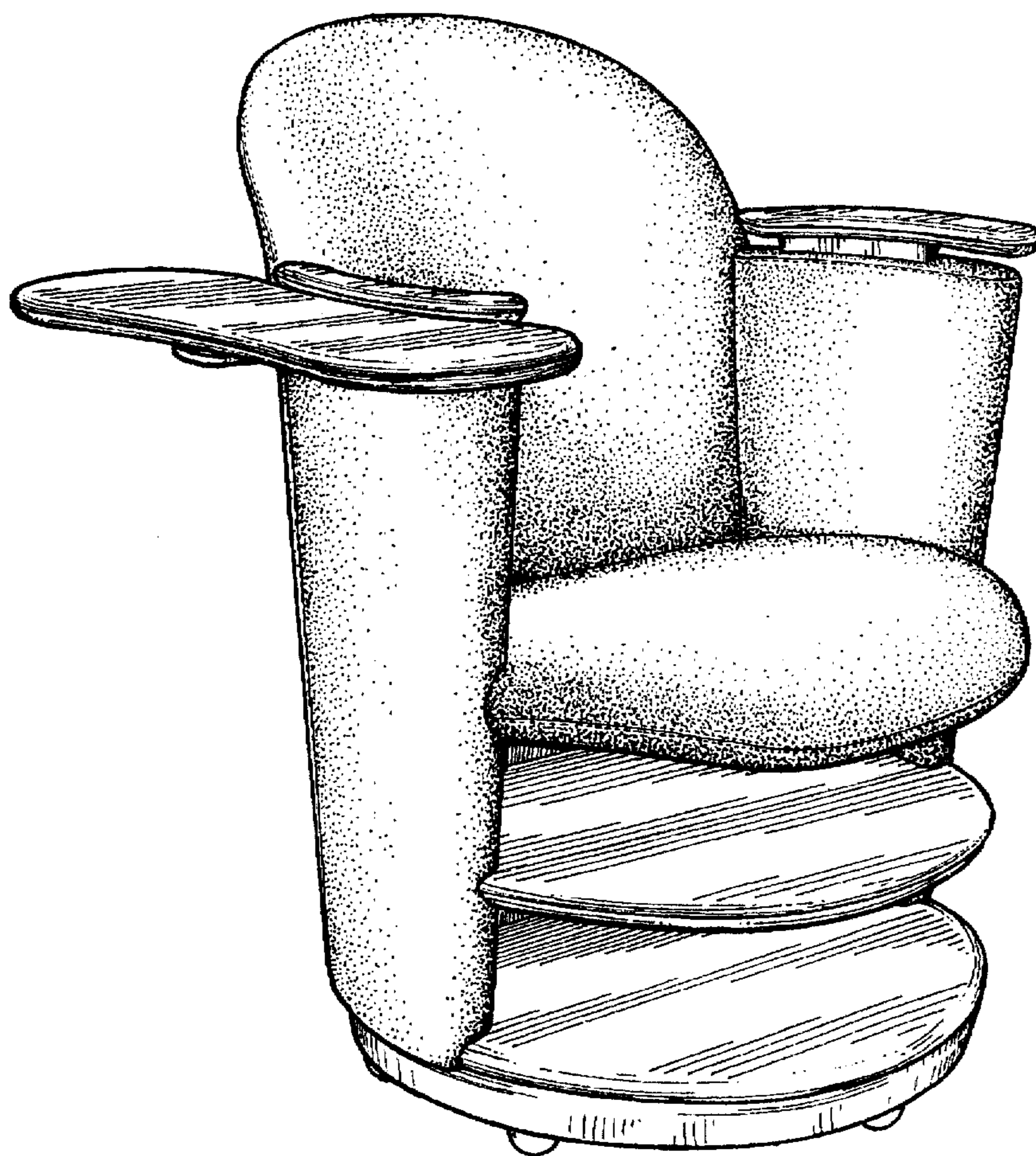

Fig. 6

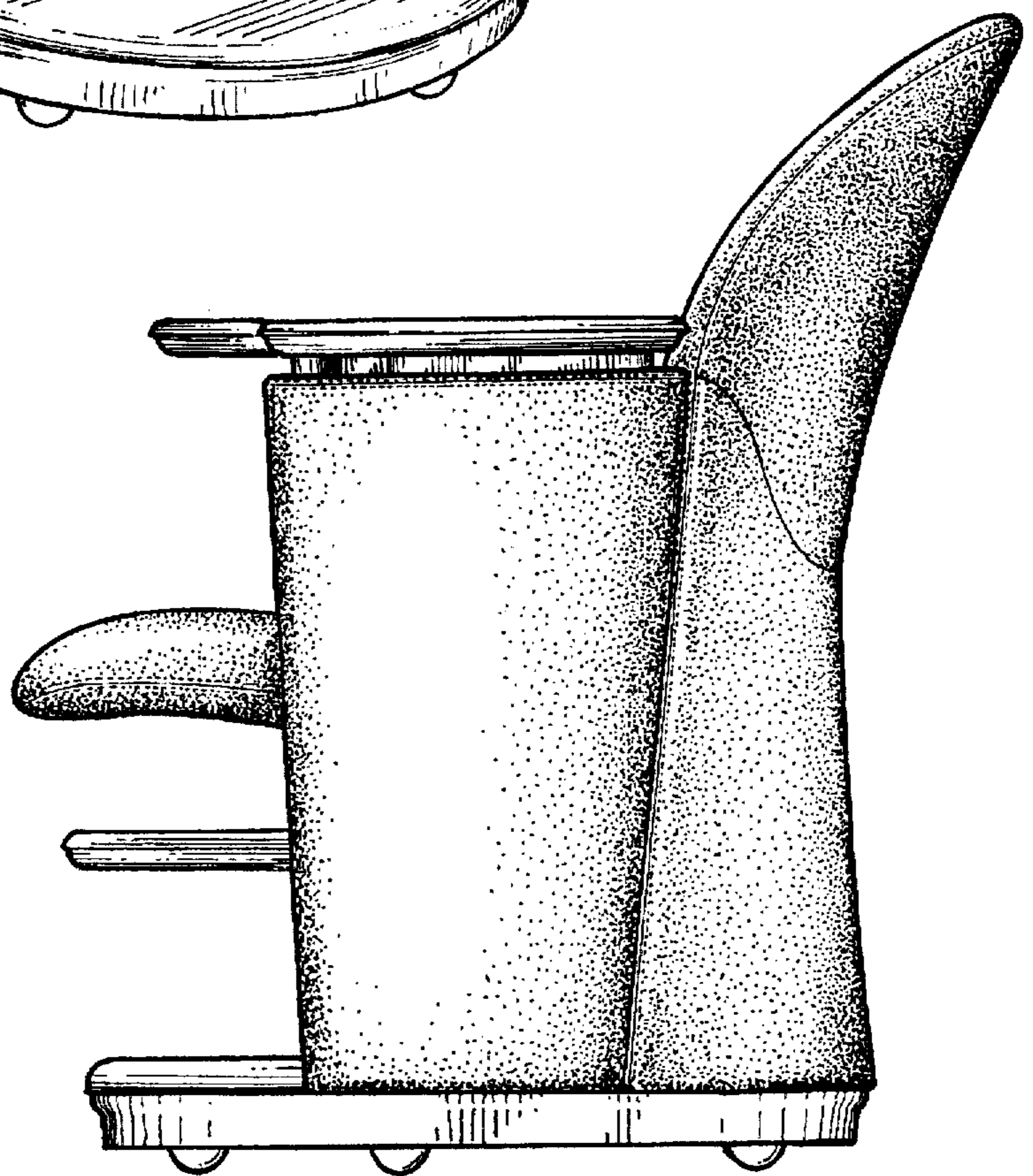

Fig. 7

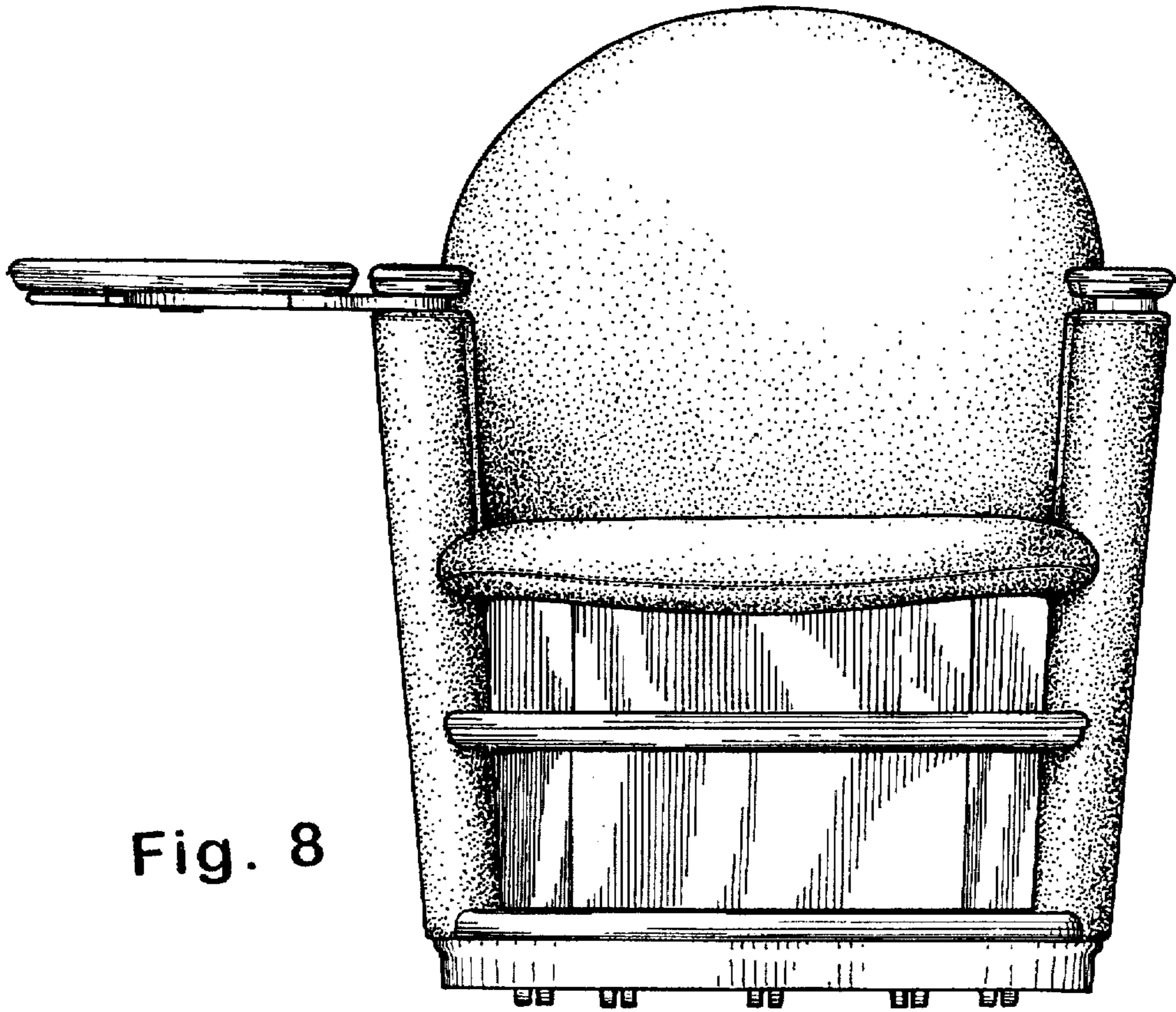

Fig. 8

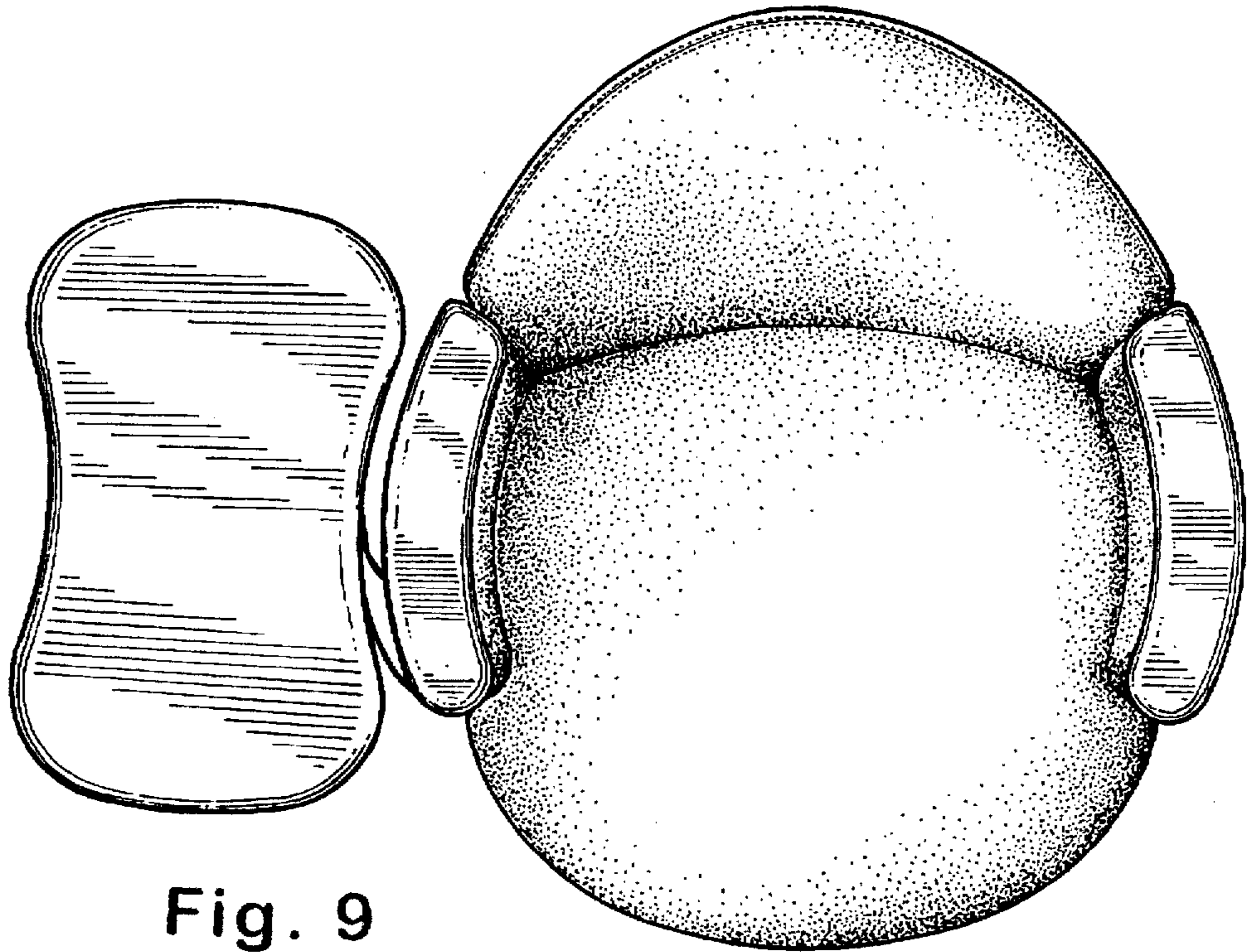

Fig. 9

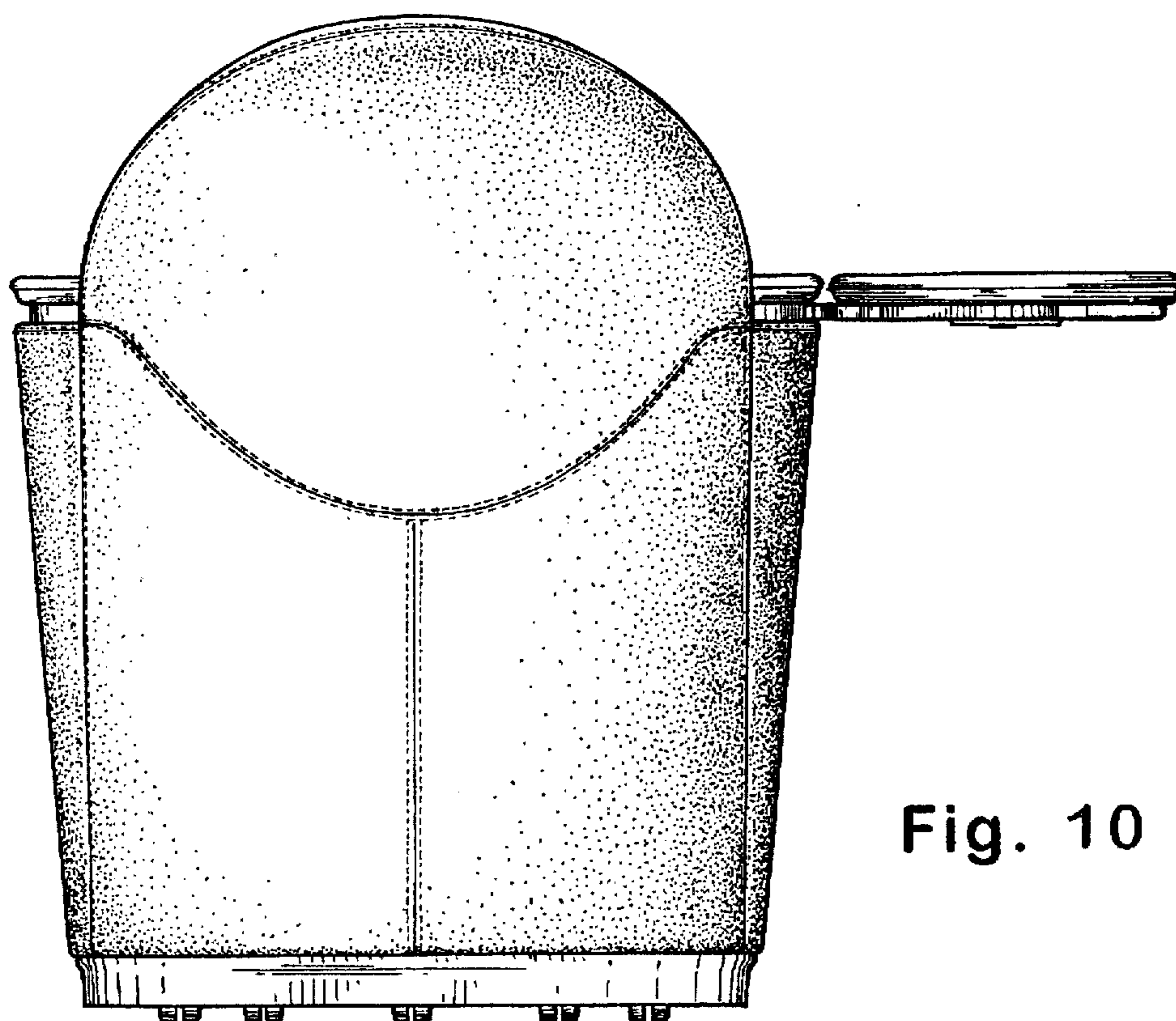

Fig. 10

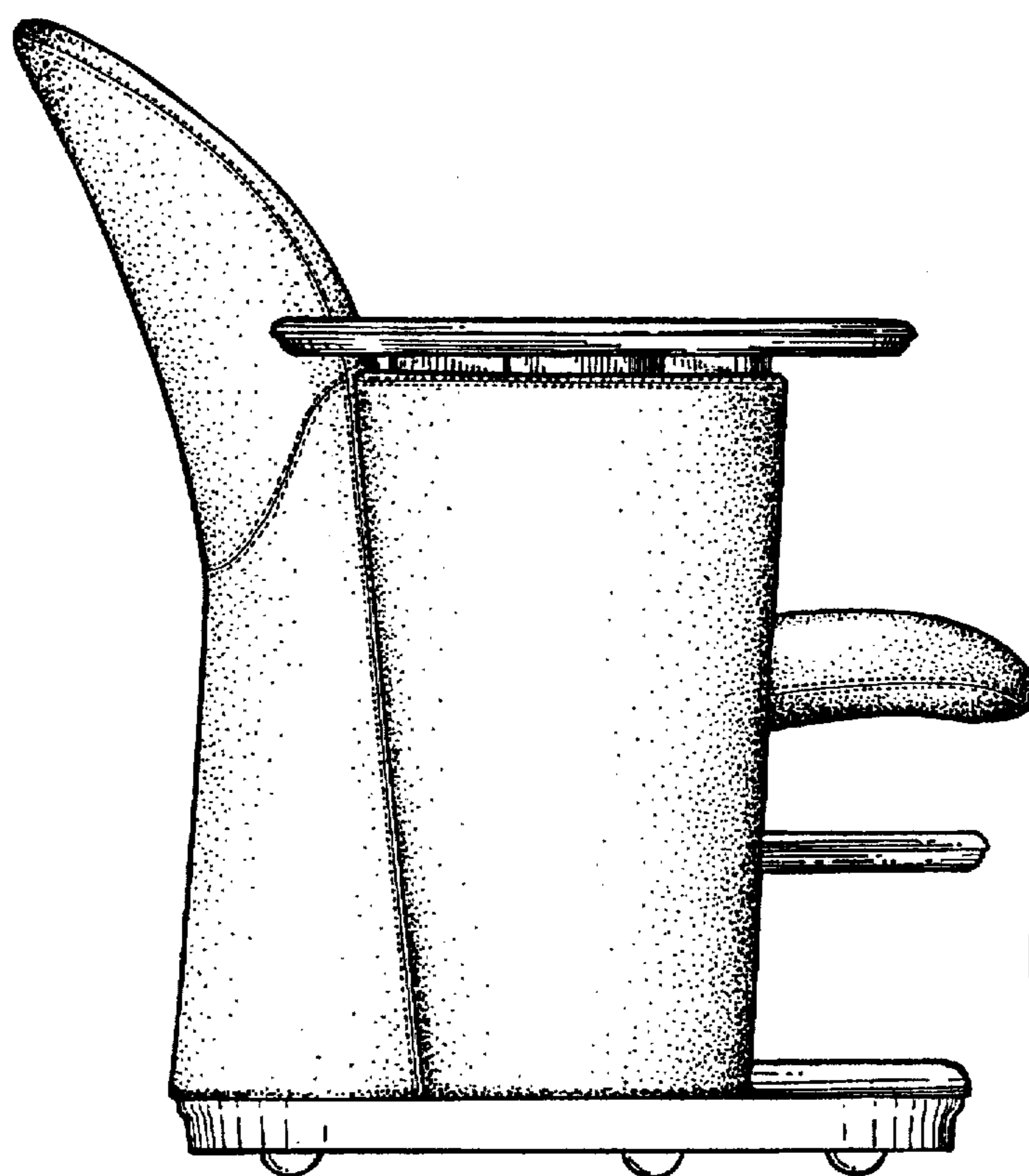

Fig. 11

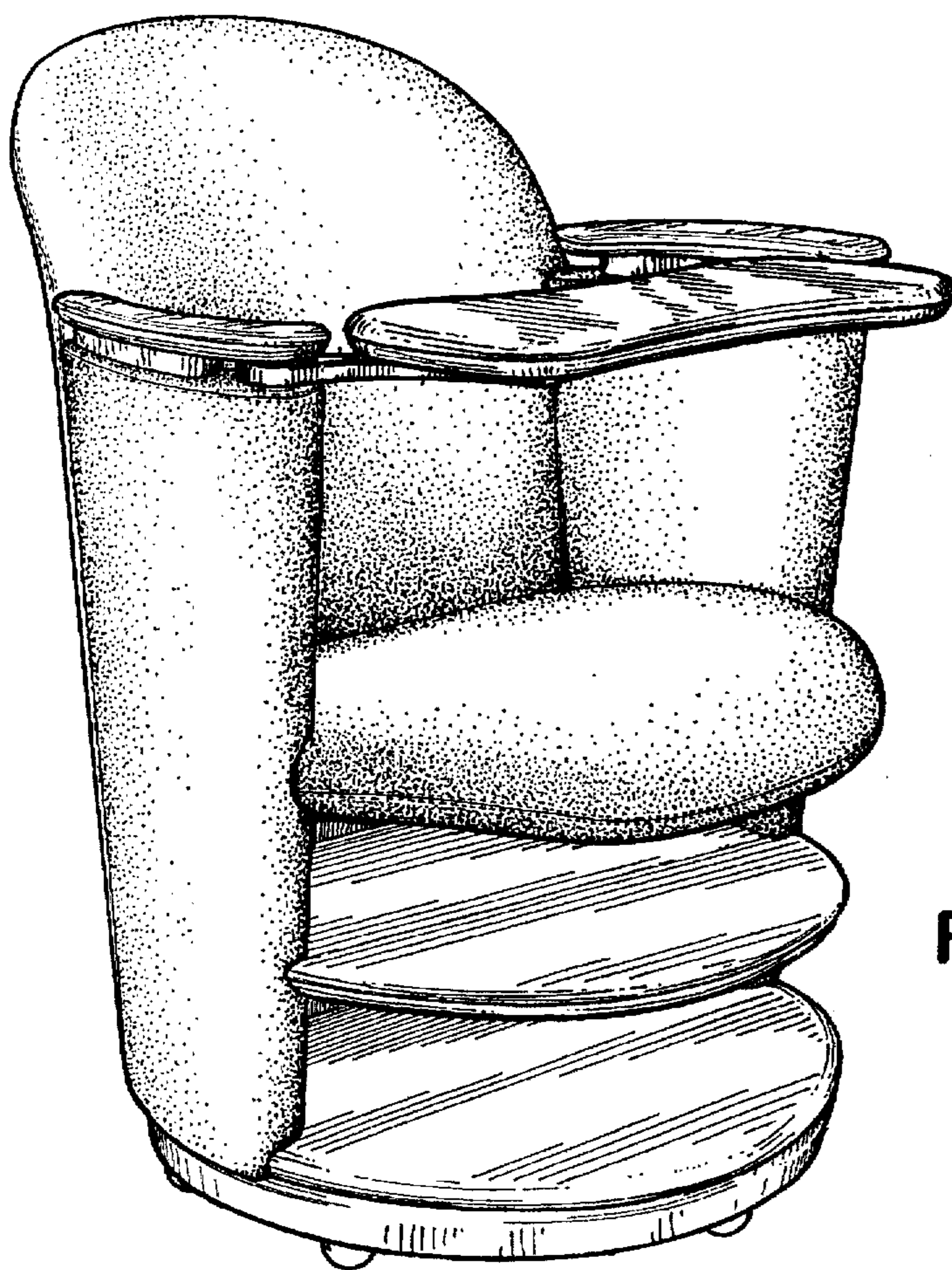

Fig. 12

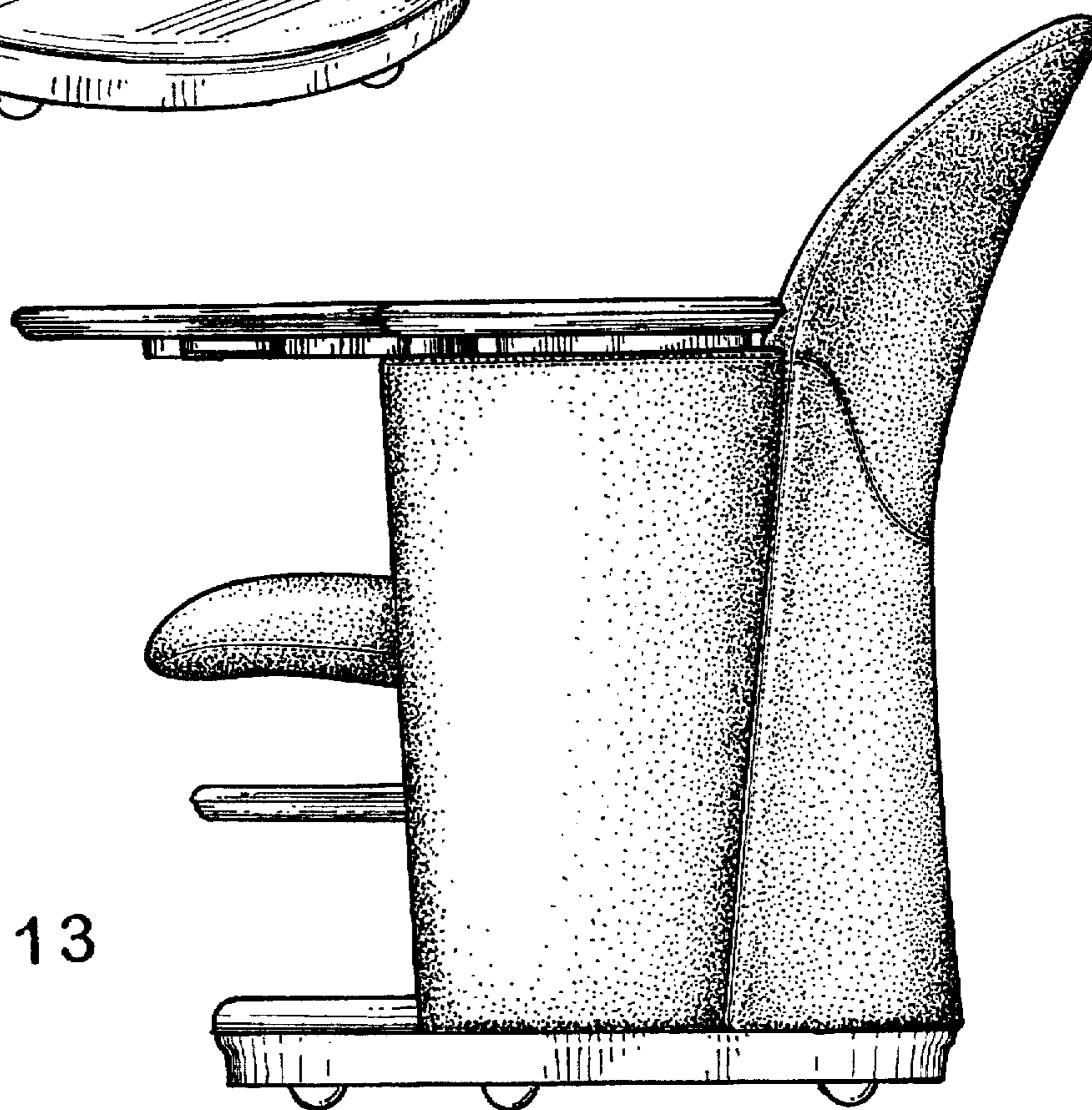

Fig. 13



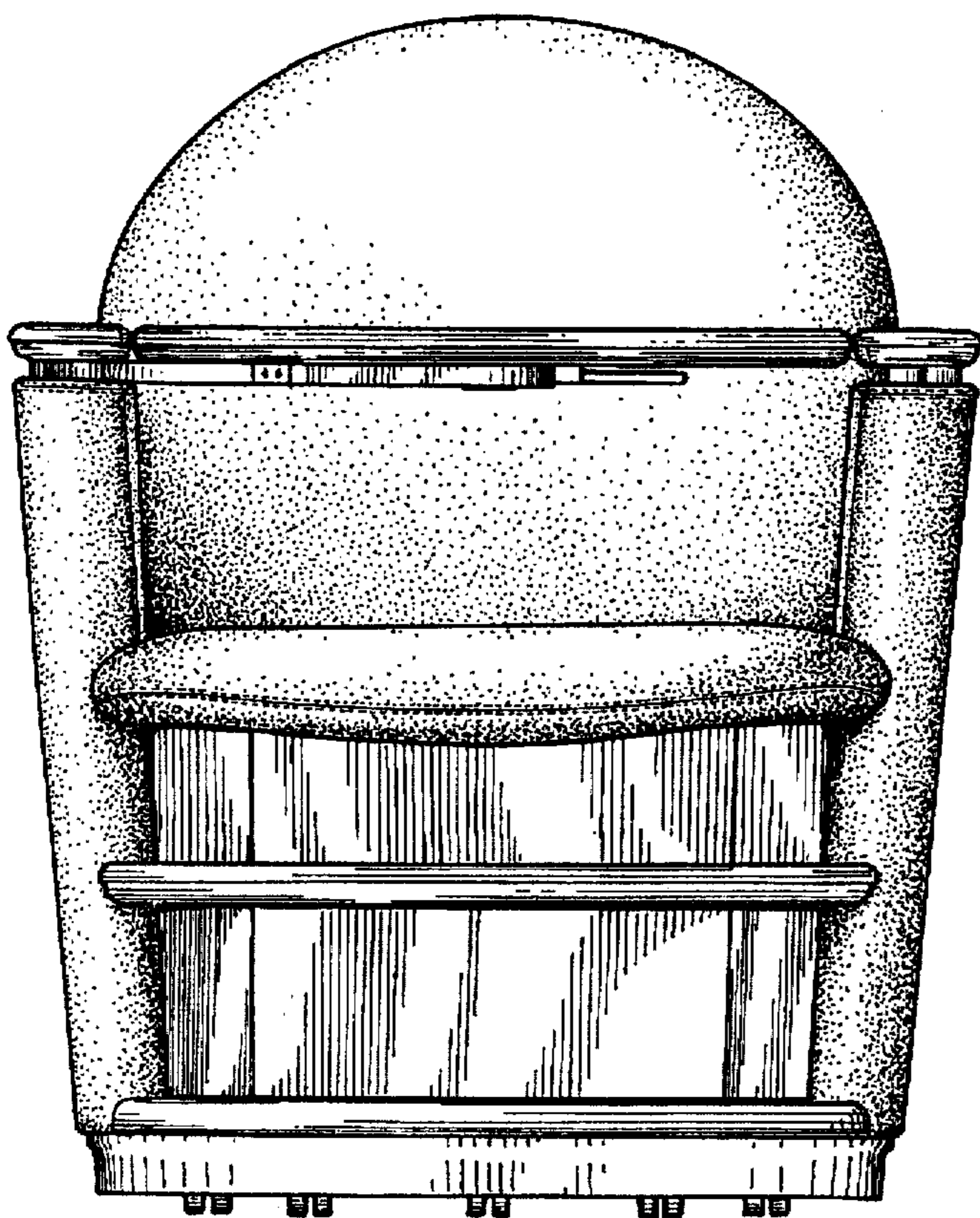

Fig. 14

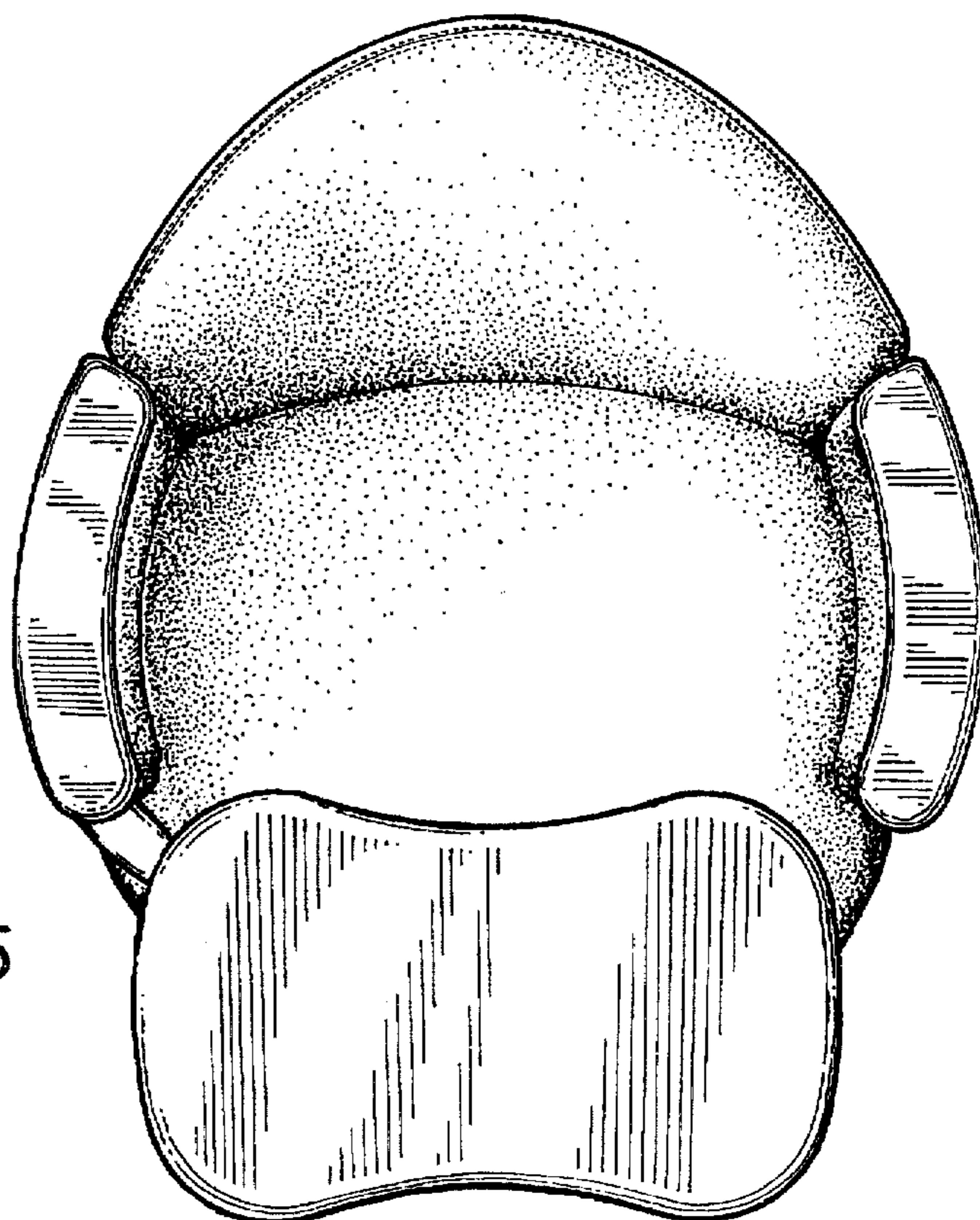

Fig. 15

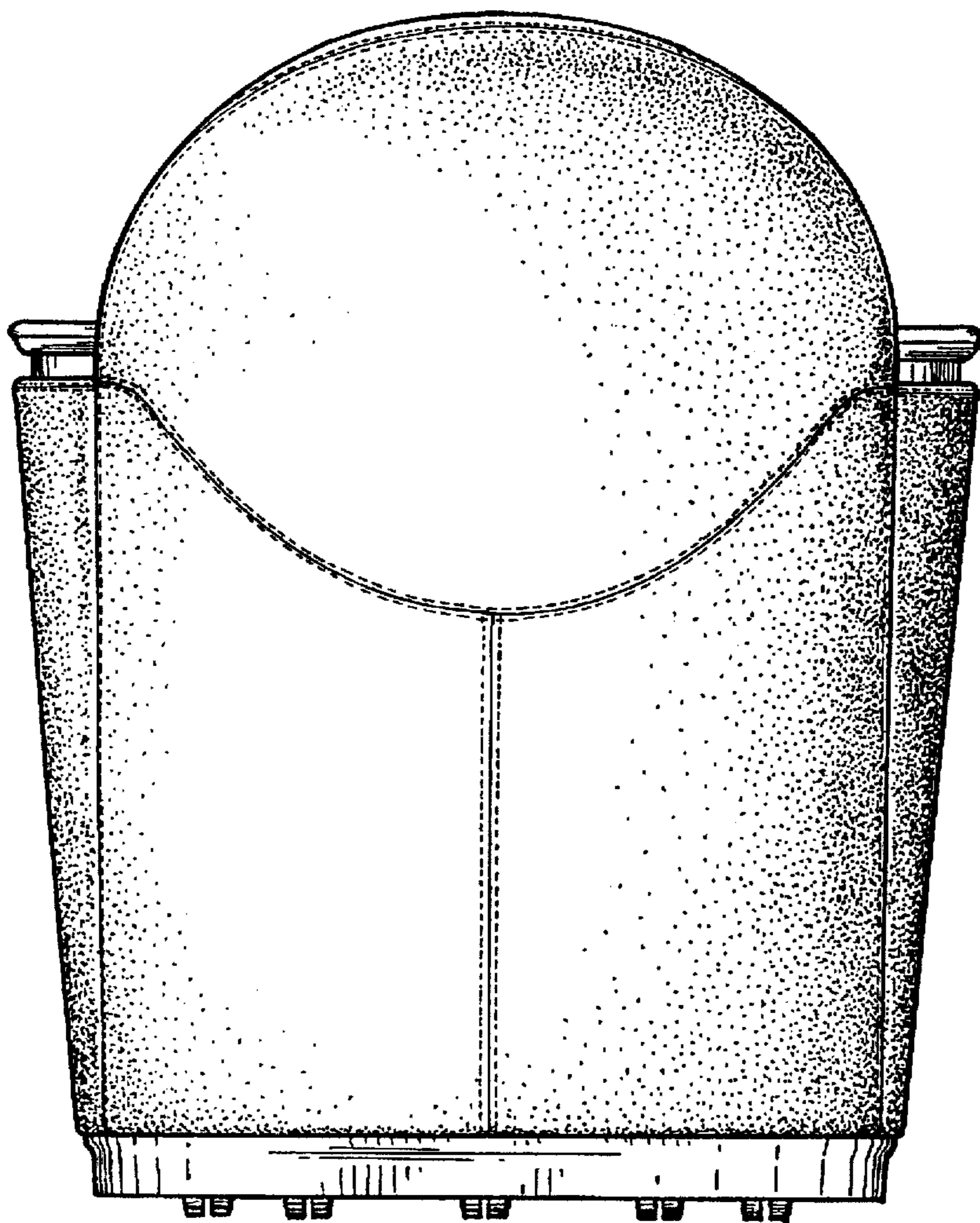

Fig. 16

UNITED STATES PATENT AND TRADEMARK OFFICE  
**CERTIFICATE OF CORRECTION**

PATENT NO. : Des. 385,423  
DATED : October 28, 1997  
INVENTOR(S) : Michael R. Shields

It is certified that error appears in the above-identified patent and that said Letters Patent is hereby corrected as shown below:

In the Description, insert as a new paragraph after "Fig. 4 is a top view thereof; and" --Fig. 5 is a rear elevational view thereof.--

In the Description of Fig. 6, Line 2;  
"table" should be --tablet--.

In the Description of Fig. 12, Line 2;  
"Fig. 13" should be --Fig. 6--.

In the Description of Fig. 12, Line 2;  
"table" should be --tablet--.

In the Description of Fig. 13, Line 2;  
"new" should be --view--.

In the Description of Fig. 15, Line 1;  
After "and" delete ",".

Signed and Sealed this  
Thirtieth Day of December, 1997



*Attest:*

BRUCE LEHMAN

*Attesting Officer*

*Commissioner of Patents and Trademarks*