



US00D385371S

# United States Patent [19]

Yemini

[11] Patent Number: **Des. 385,371**

[45] Date of Patent: **\*\*Oct. 21, 1997**

## [54] FLASHLIGHT

[75] Inventor: **Zvi Yemini, Tel Aviv, Israel**

[73] Assignee: **Zag Ltd., Tel Aviv, Israel**

[\*\*] Term: **14 Years**

[21] Appl. No.: **46,515**

[22] Filed: **Nov. 17, 1995**

[51] LOC (6) Cl. .... **26-02**

[52] U.S. Cl. .... **D26/43**

[58] Field of Search ..... **D26/37, 38, 43, D26/46, 48, 49, 60, 61; 362/157, 158, 196, 197, 198, 202, 203, 204, 205, 207, 208**

## [56] References Cited

### U.S. PATENT DOCUMENTS

- D. 208,940 10/1967 Moore ..... D26/37
- D. 361,399 8/1995 Carbone et al. .... D26/43
- 2,435,689 2/1948 McCabe ..... 362/203

## FOREIGN PATENT DOCUMENTS

- 685931 8/1986 Japan ..... D26/43
- 685937 8/1986 Japan ..... D26/43

*Primary Examiner*—A. Hugo Word  
*Assistant Examiner*—Lavone D. Tabor  
*Attorney, Agent, or Firm*—Mark M. Friedman

## [57] CLAIM

The ornamental design for a flashlight, as shown.

## DESCRIPTION

FIG. 1 is a right side view of a flashlight showing my new design;  
 FIG. 2 is a left side view of a flashlight showing my new design;  
 FIG. 3 is a rear view of a flashlight showing my new design;  
 FIG. 4 is a front view of a flashlight showing my new design;  
 FIG. 5 is a top view of a flashlight showing my new design;  
 and,  
 FIG. 6 is a bottom view of a flashlight showing my new design.

**1 Claim, 4 Drawing Sheets**

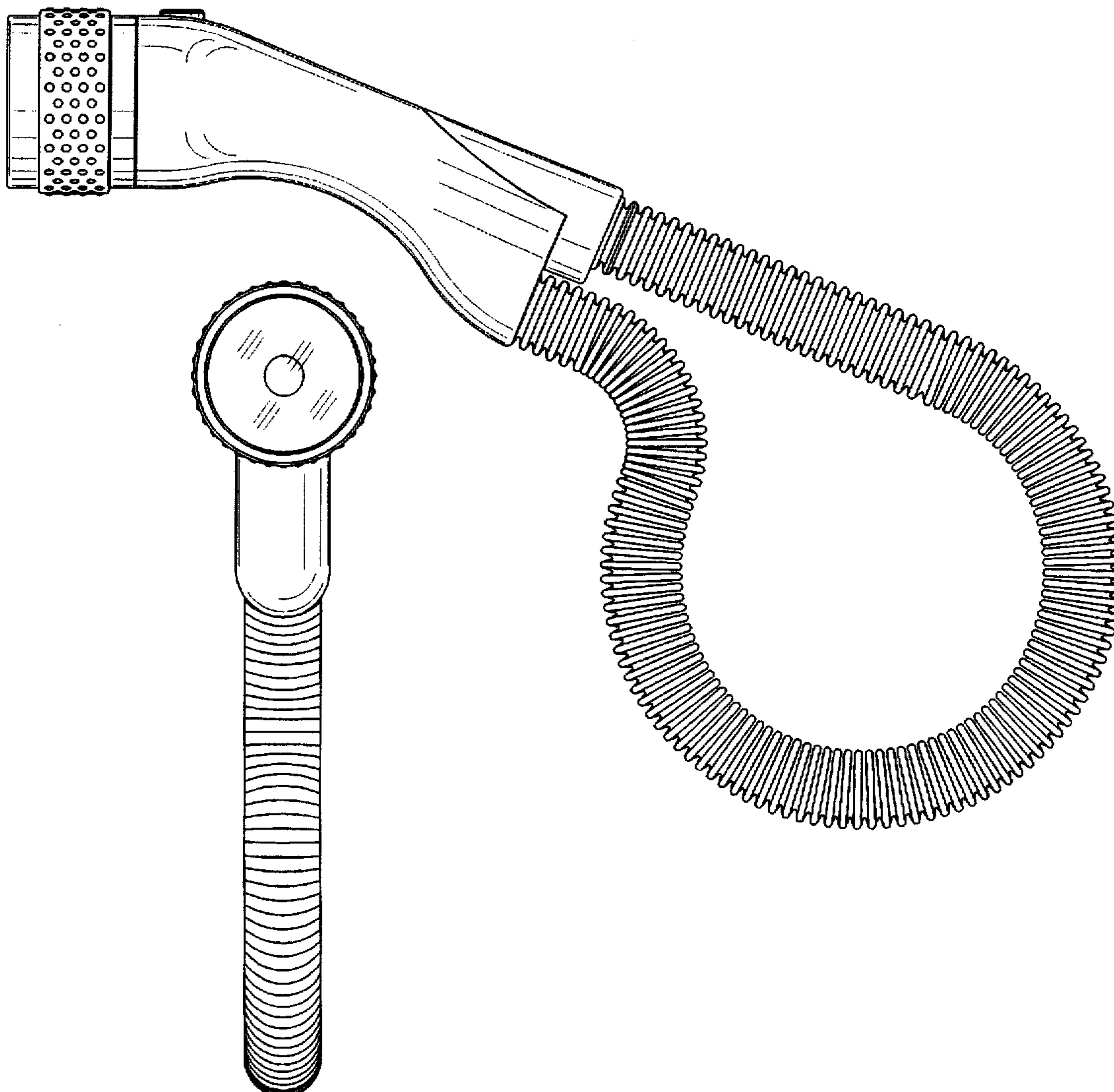

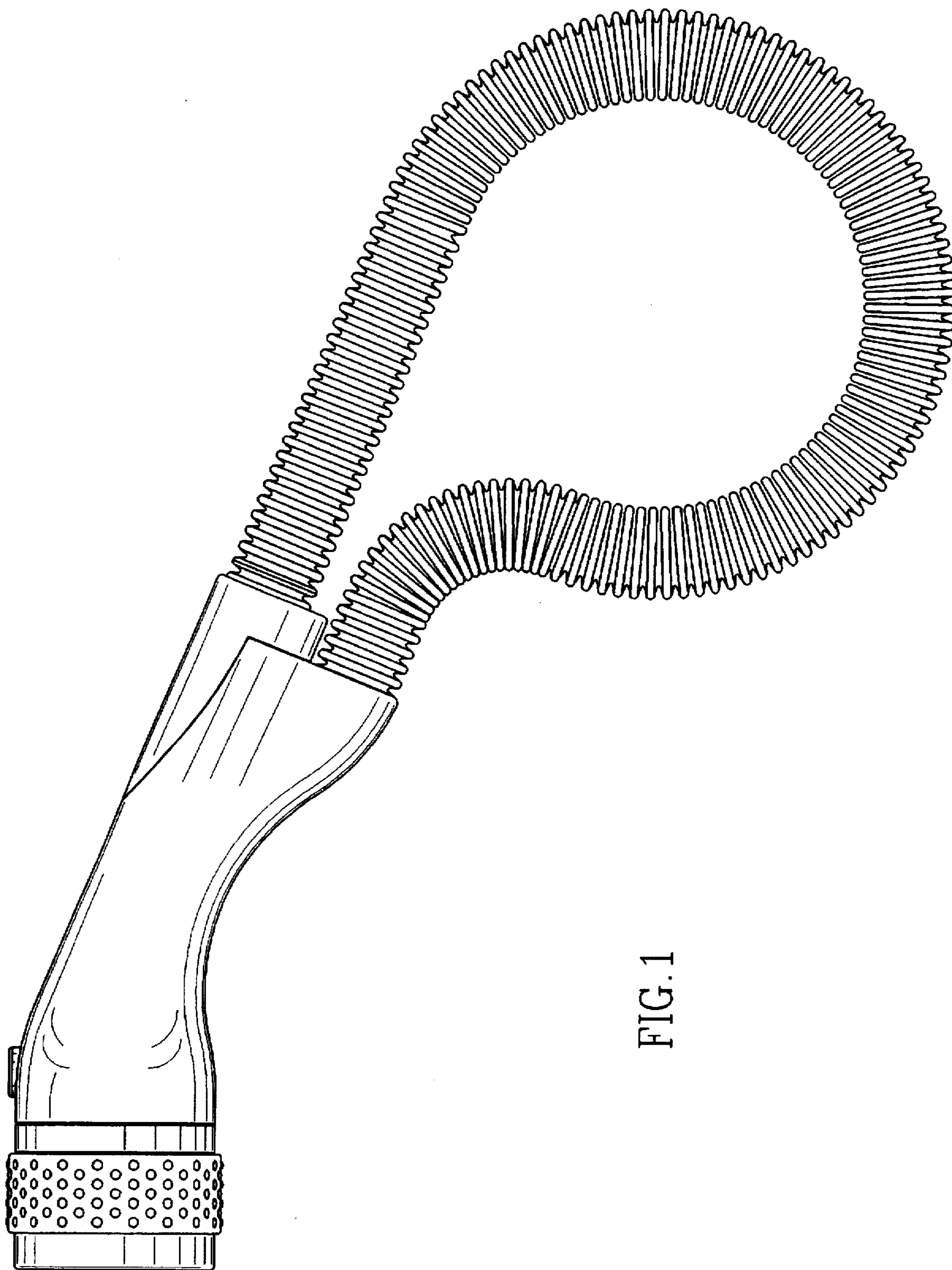

FIG. 1

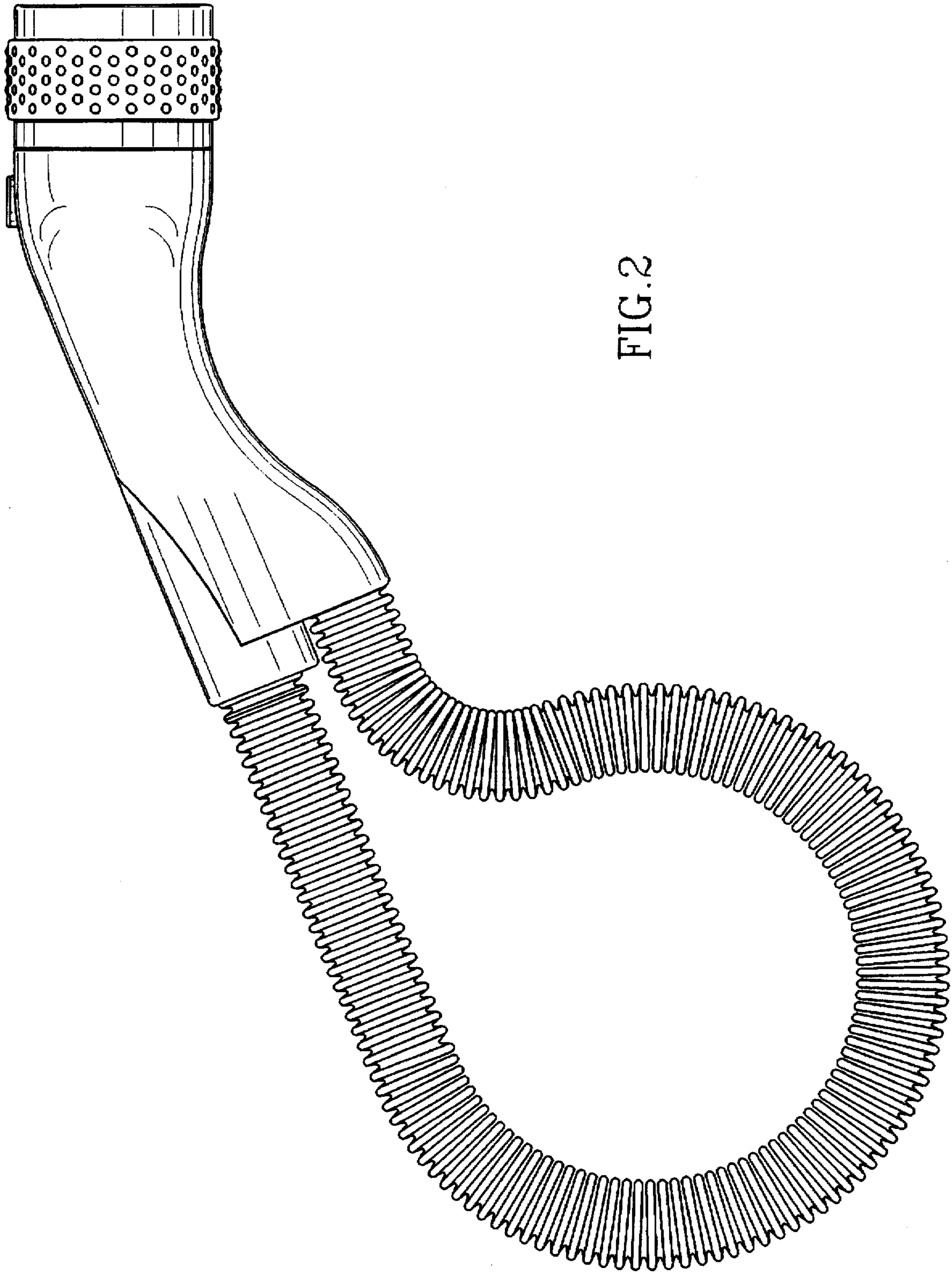

FIG.2

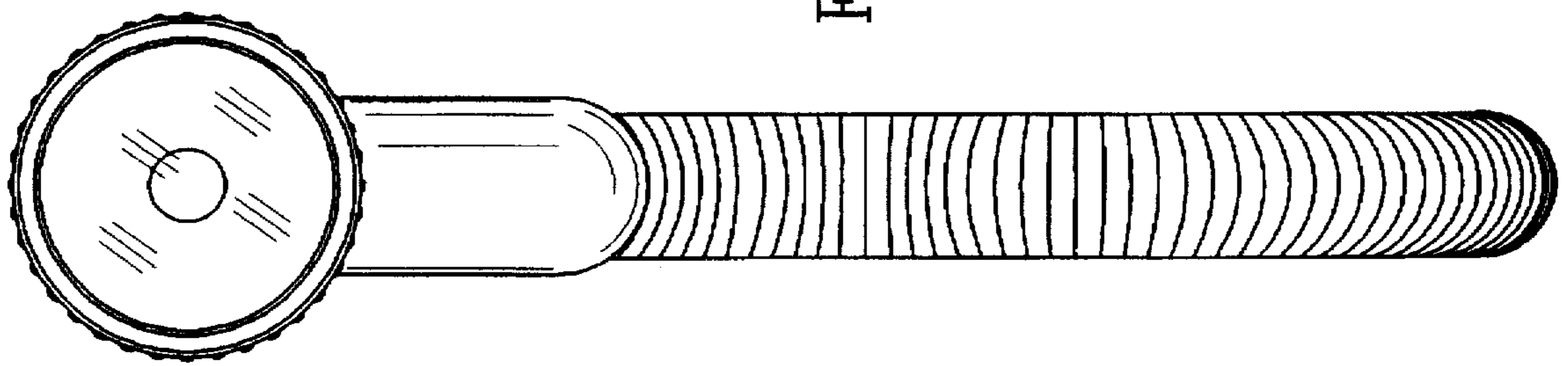

FIG. 4

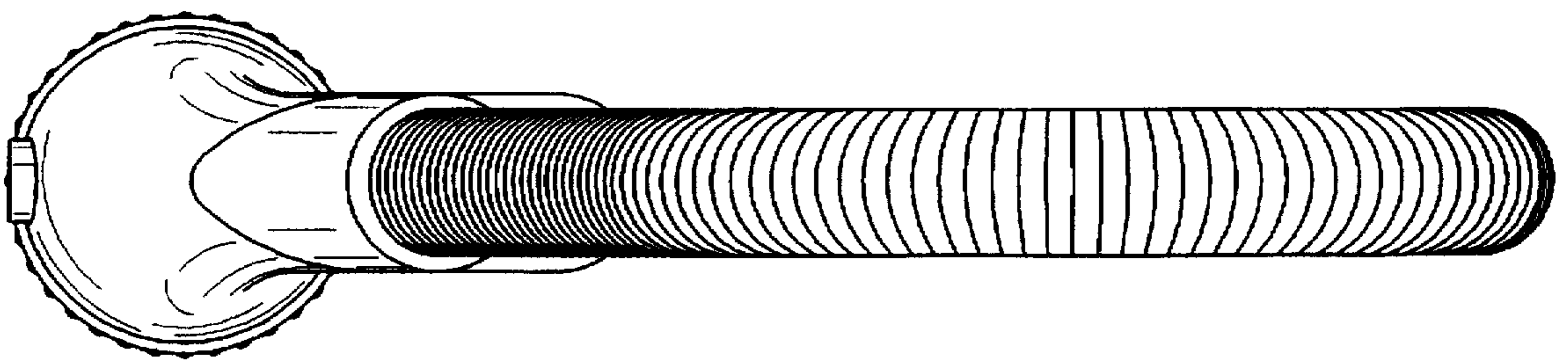

FIG. 3

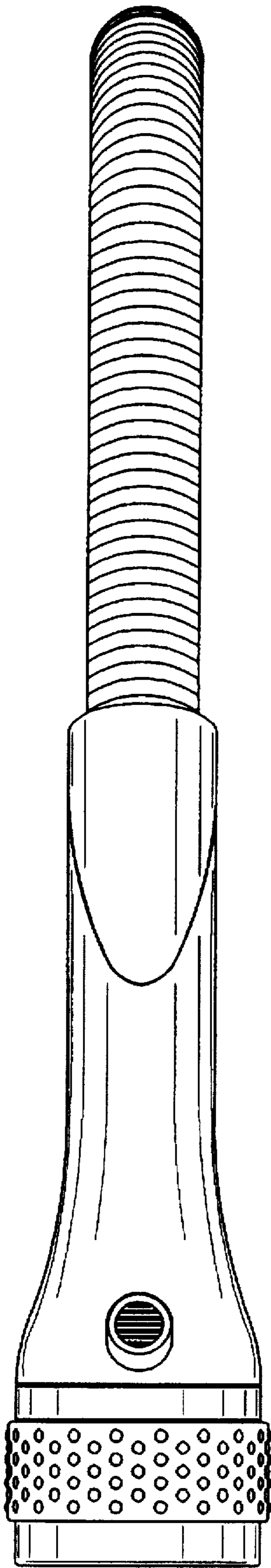

FIG. 5

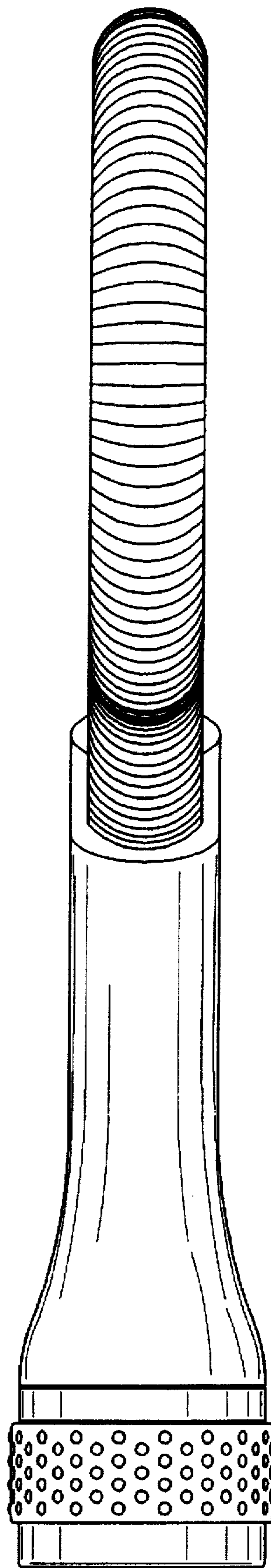

FIG. 6