



US00D385348S

United States Patent [19]

Ward et al.

[11] Patent Number: Des. 385,348

[45] Date of Patent: **Oct. 21, 1997

[54] **AMBULATORY PLATFORM FOR POLE MOUNTED INFUSION PUMPS**

J.B. Call Catalog, *J.B. Call*, 11 Guittard Road, Burlingame, CA 94010, pp. 13-14, Oct. 1992.

[75] Inventors: Michael T. Ward, Libertyville; Timothy J. Ward, Gurnee, both of Ill.

Primary Examiner—Louis S. Zarfes
Assistant Examiner—Frank Martinez
Attorney, Agent, or Firm—Speckman, Pauley & Fejer

[73] Assignee: Ivy Green Corporation, Gurnee, Ill.

[**] Term: 14 Years

[57] CLAIM

[21] Appl. No.: 34,868

The ornamental design for an ambulatory platform for pole mounted pumps, as shown.

[22] Filed: Feb. 14, 1995

DESCRIPTION

[51] LOC (6) Cl. 24-01

[52] U.S. Cl. D24/128; 248/125

[58] Field of Search D24/128; 248/121, 248/125.1, 126, 129, 131; 604/80, 259

FIG. 1 is a front view of an ambulatory platform for pole mounted infusion pumps, showing our new design;

FIG. 2 is a rear view of the ambulatory platform for pole mounted infusion pumps shown in FIG. 1;

FIG. 3 is a left side view of the ambulatory platform for pole mounted infusion pumps shown in FIG. 1;

FIG. 4 is a right side view of the ambulatory platform for pole mounted infusion pumps shown in FIG. 1;

FIG. 5 is a top view of the ambulatory platform for pole mounted infusion pumps shown in FIG. 1; and,

FIG. 6 is a bottom view of the ambulatory platform for pole mounted infusion pumps shown in FIG. 1.

[56] References Cited

U.S. PATENT DOCUMENTS

4,332,378	6/1982	Pryor	D24/128	X
4,832,294	5/1989	Eidem	D24/128	X
4,905,944	3/1990	Jost et al.	D24/128	X
4,966,340	10/1990	Hunter	248/125	
5,337,992	8/1994	Pryor et al.	248/125.1	
5,421,548	6/1995	Bennett et al.	248/129	

OTHER PUBLICATIONS

Advertisement from McGaw Incorporated, 2525 McGaw Avenue, CA 92714-5895, entitled "McGaw Home Care I.V. Caddy," Catalog Number: N7519, (2 pages).

1 Claim, 6 Drawing Sheets

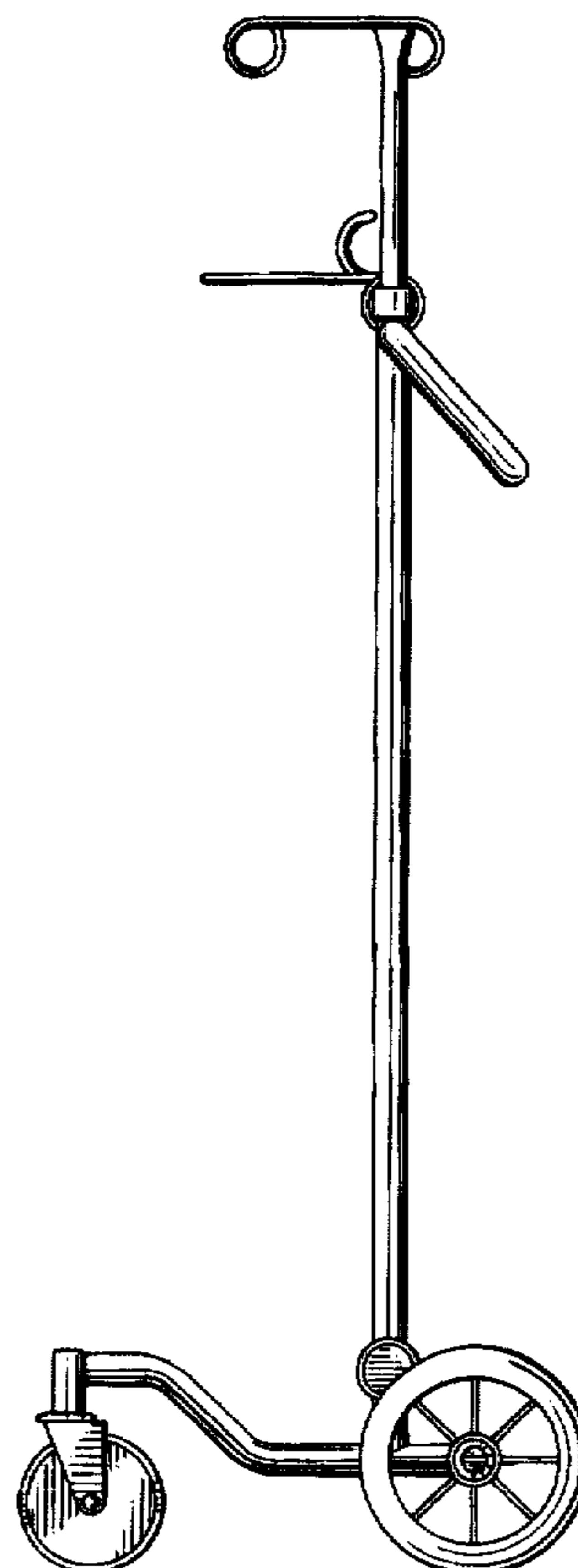
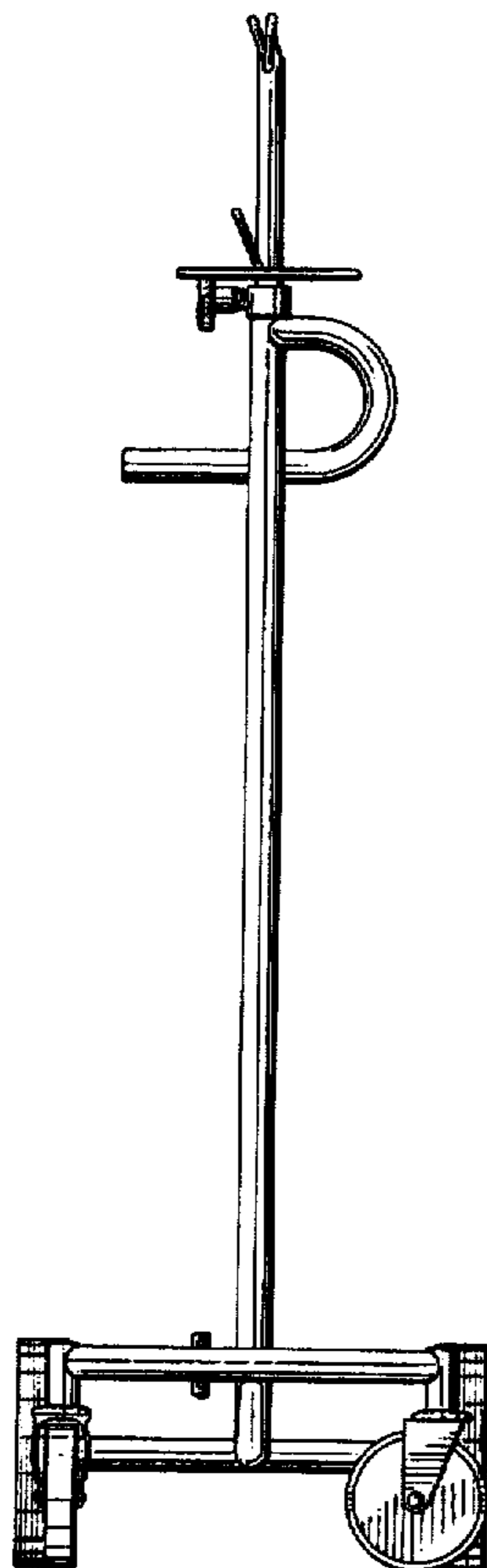

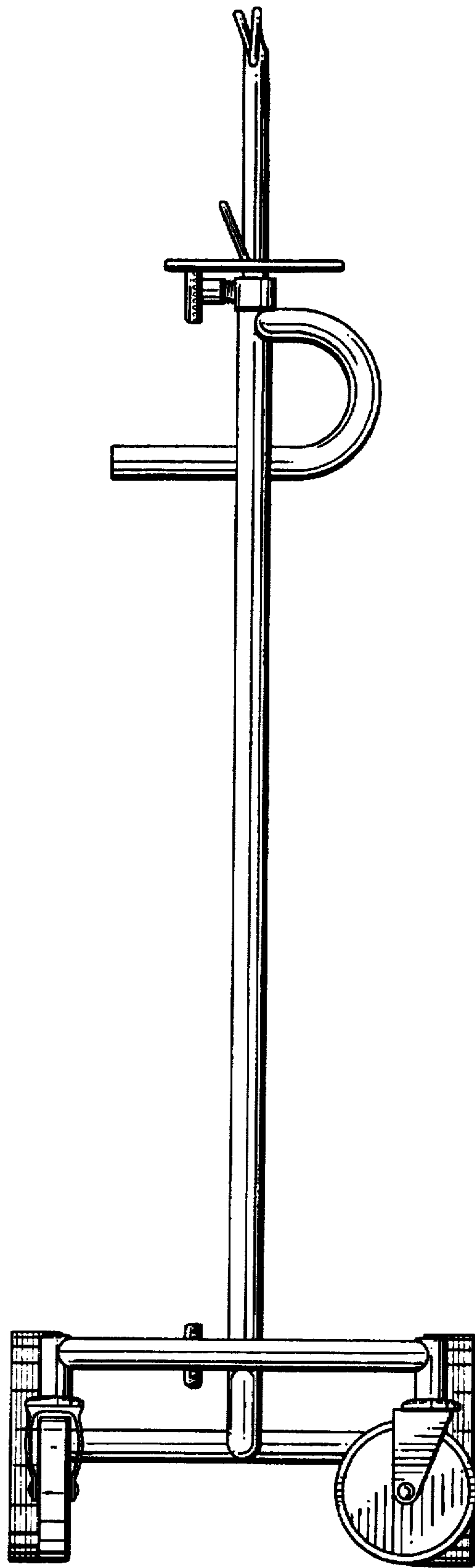

FIG. 1

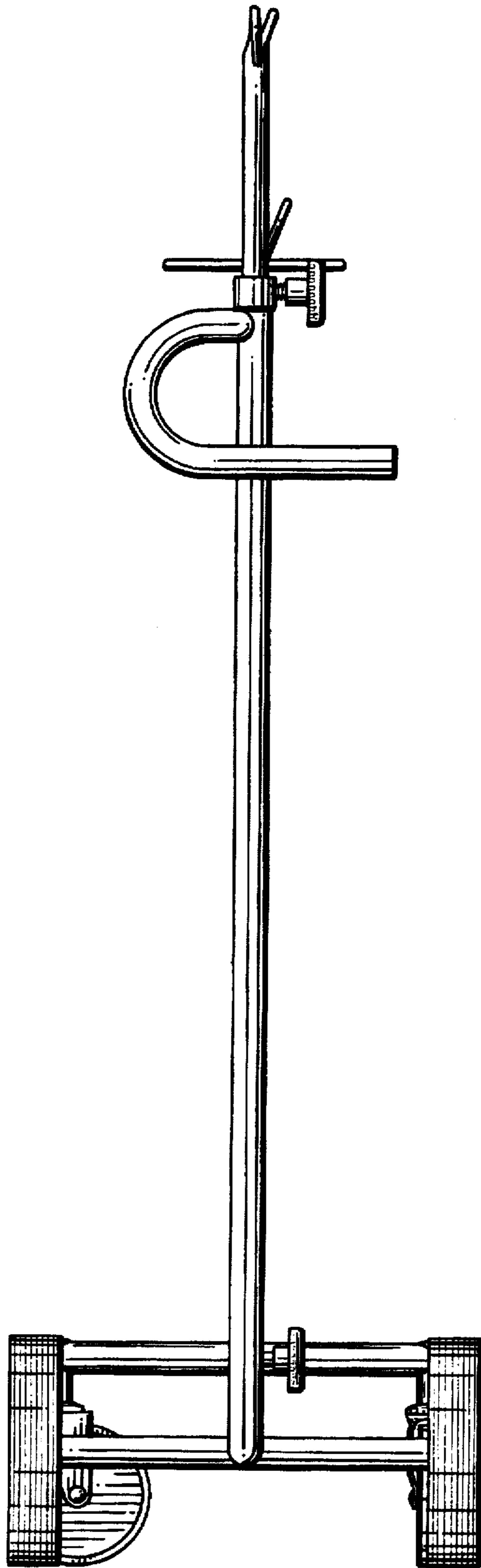

FIG. 2

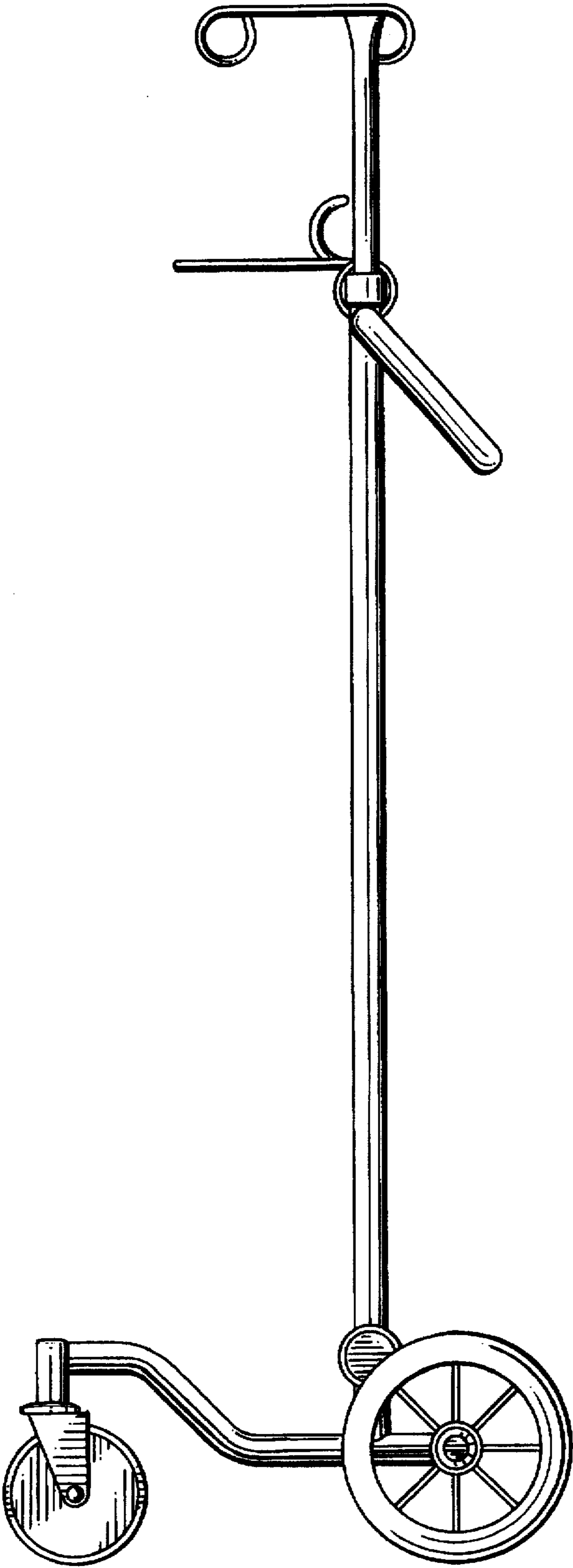

FIG.3

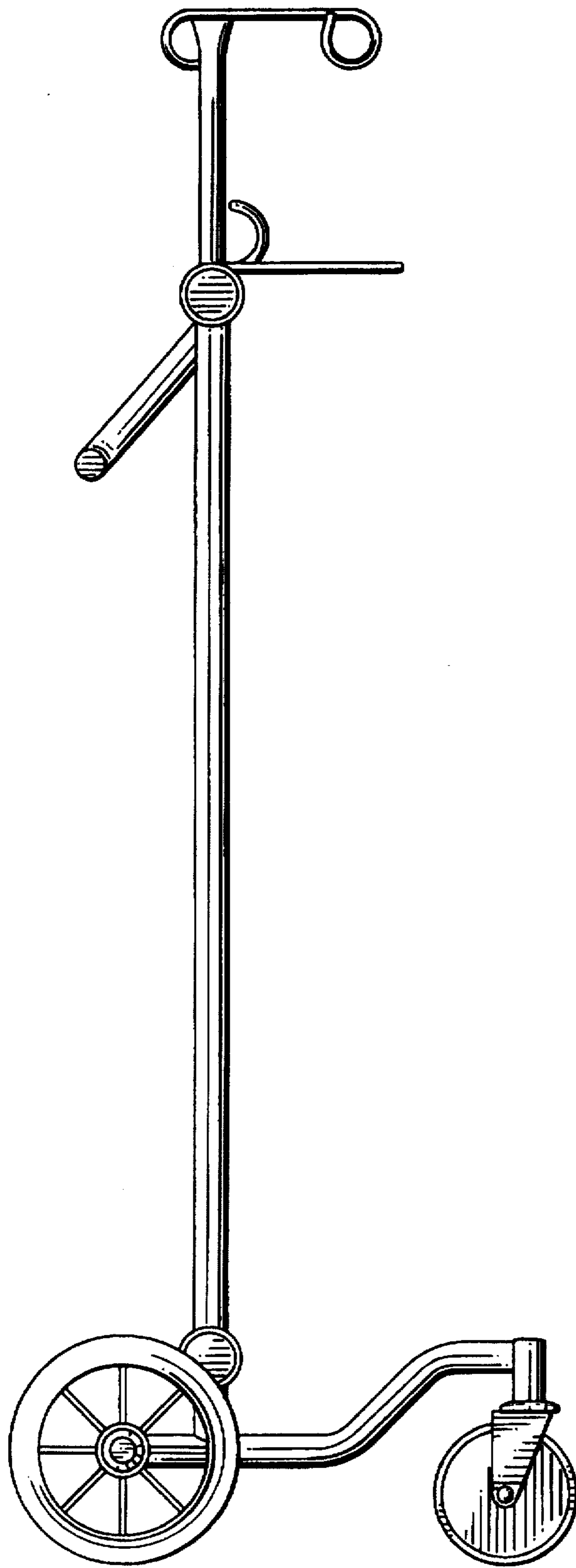

FIG. 4

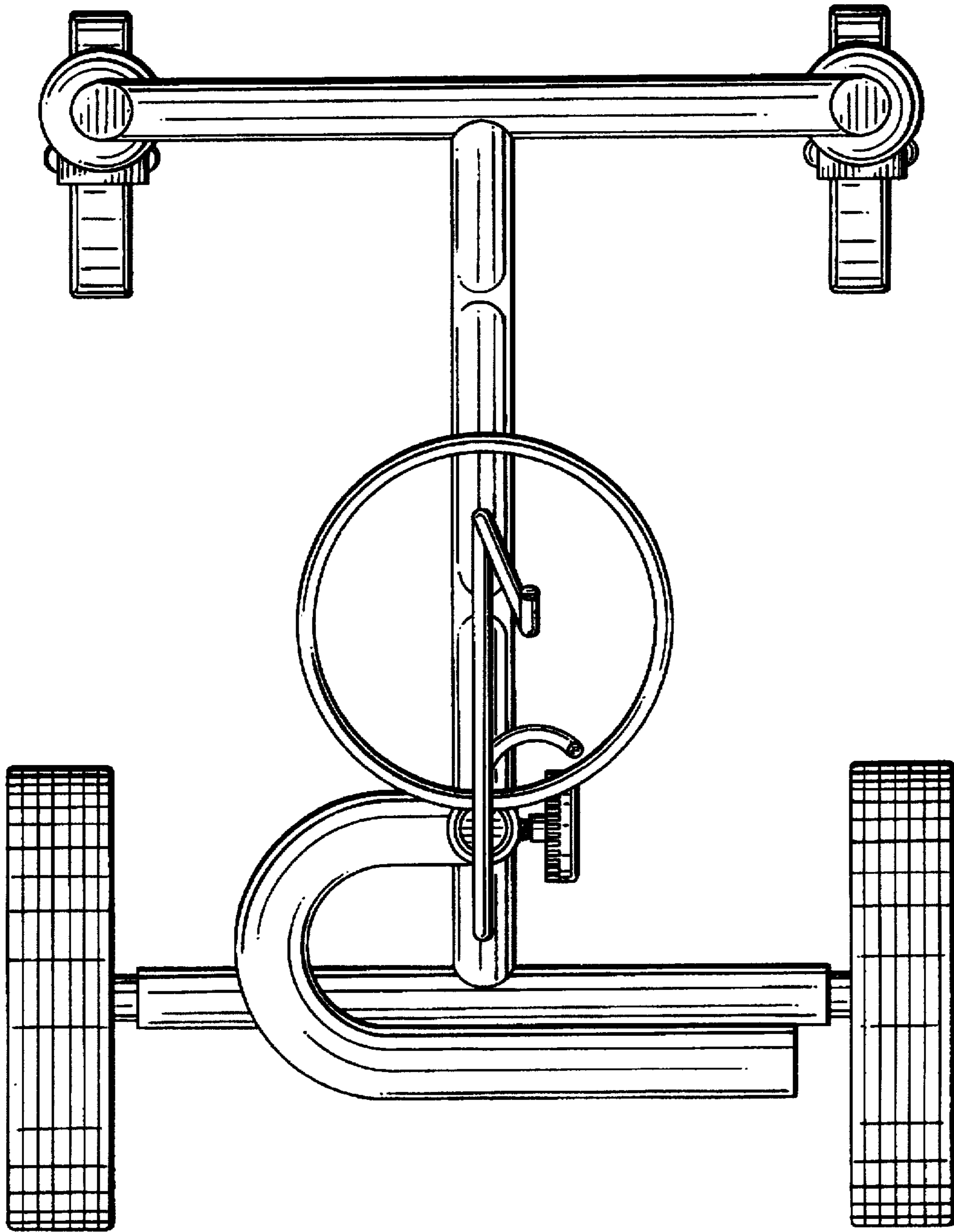

FIG. 5

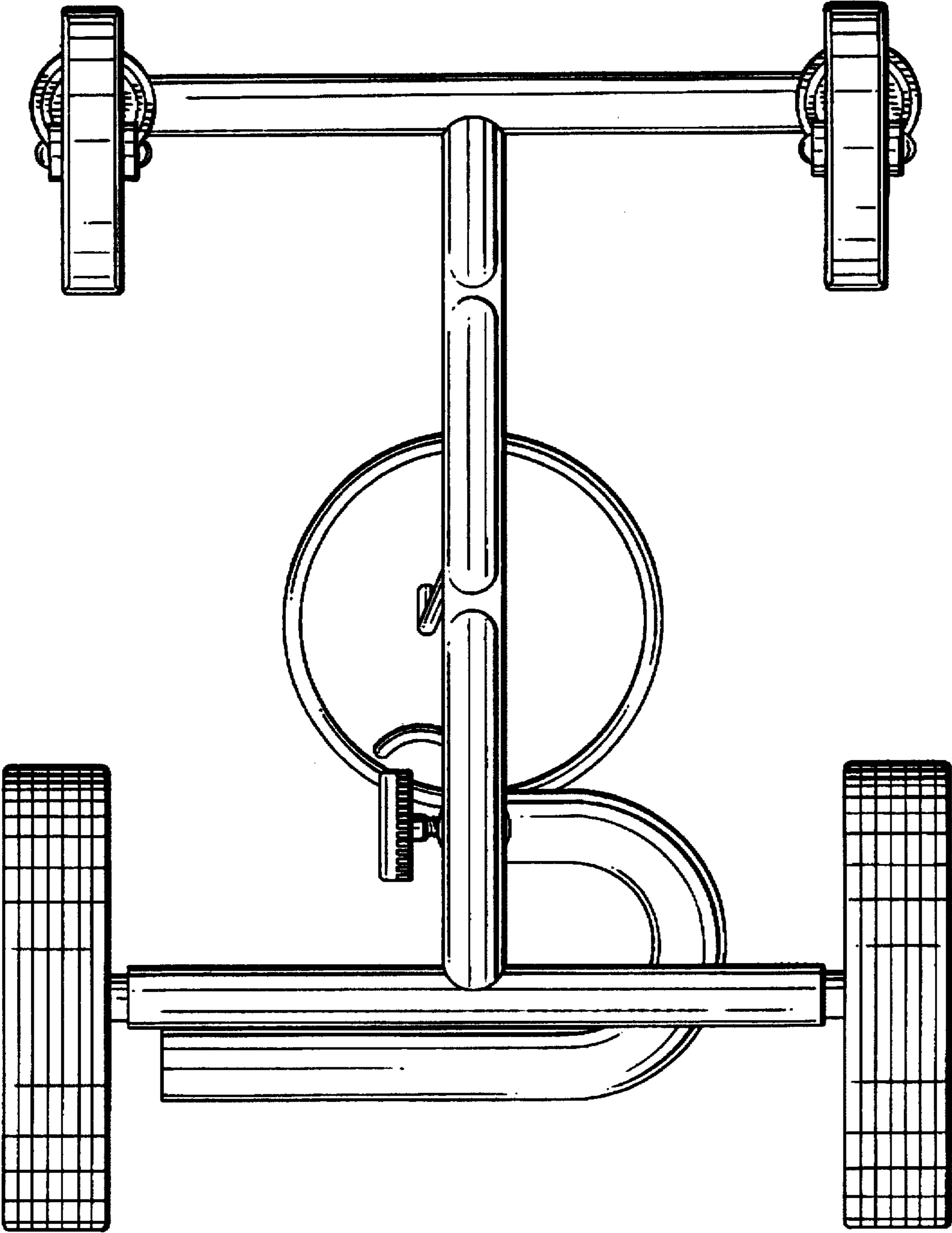

FIG. 6